

TRANSACTIONS
OF THE
ROYAL SOCIETY

OF
EDINBURGH.



VOL. XVII.—PART I.

CONTAINING THE
MAKERSTOUN MAGNETICAL AND METEOROLOGICAL
OBSERVATIONS

FOR
1841 AND 1842.

EDINBURGH :
PUBLISHED BY ROBERT GRANT & SON, 82 PRINCES STREET ; AND
T. CADELL, STRAND, LONDON.

MDCCCXLV.

PRINTED BY NEILL AND CO., OLD FISHMARKET, EDINBURGH.

OBSERVATIONS

IN

MAGNETISM AND METEOROLOGY,



MADE AT

MAKERSTOUN IN SCOTLAND,

IN THE OBSERVATORY OF

GENERAL SIR T. M. BRISBANE, BART.,

G.C.B., G.C.H., D.C.L., LL.D., COR. MEM. INST. FR., PRES. R.S.E., F.R.S., F.R.A.S., H.M.R.I.A., &c. &c.

1841 AND 1842.

UNDER THE DIRECTION OF

E. RUSSELL, Esq., IN 1841, AND OF JOHN A. BROUN, Esq., IN 1842.

THE WHOLE EDITED BY

JOHN A. BROUN, Esq.

EDINBURGH:

PRINTED BY NEILL AND COMPANY.

MDCCLXV.

CONTENTS.

	PAGE
PREFACE,	vii
INTRODUCTION—	
Description and Position of the Observatory,	ix
Personal Establishment,	x
MAGNETICAL INSTRUMENTS—	
<i>Declinometer</i> —	
Description of the Declinometer,	xi
Value of the Scale Divisions,	xii
Reading for Magnetic Axis,	xiii
Effect of Bifilar and Balance Magnets,	xiv
Effect of Copper Ring,	xv
Suspension Thread and its Torsion Force,	xvi
Values of $\frac{H}{F}$,	xvi
Facts relating to Suspension Threads,	xvii
Absolute Declination,	xix
Method of Observing,	xxiii
<i>Bifilar Magnetometer</i> —	
Description of the Instrument,	xxiii
Constants for the Reduction of Observations after altering the Reading of the Torsion Circle,	xxv
Adjustments,	xxv
Value of Scale Divisions,	xxvi
Times of Vibration,	xxviii
Mode of Observing and Reductions,	xxix
Values of k and q ,	xxx
Sources of error in determining the Temperature of the Magnet,	xxx
Absolute Horizontal Intensity,	xxxi
<i>Balance Magnetometer</i> —	
Description of the Instrument,	xxxii
Value of Micrometer Divisions,	xxxiii
Deviation of Magnetic Axis from the line joining the Bisection Crosses,	xxxiv
Times of Vibration in a Horizontal Plane,	xxxv
Times of Vibration in a Vertical Plane,	xxxvi
Effect of other Magnets,	xxxvii
Observations and Reductions,	xxxvii
Values of k and q ,	xxxix

	PAGE
<i>Observations for the Temperature Corrections—</i>	
Method of Observation,.....	xxxix
For the Bifilar Magnet,.....	xli
For the Balance Magnet,	xlii
New Method of determining the Temperature Correction,	xliv
<i>Inclinometer—</i>	
Description of Instrument, and Method of Observing,	xlv
Observations in different Azimuths,	xlvi
METEOROLOGICAL INSTRUMENTS.	
<i>Barometer—</i>	
Description of the Instruments used,	xlvii
Comparisons with the Royal Society's Standard,	xlvii
<i>Thermometers—</i>	
Positions of the Thermometers,	xlvii
Corrections of the Thermometers to the Standard,	xlix
<i>Rain Gauges—</i>	
Positions of the Gauges,	xlix
<i>Anemometer—</i>	
Description of the Instruments,	1
<i>State of the Sky—</i>	
Mode of Observation,	li
<i>General and Recapitulatory Remarks—</i>	
Stove,	li
Clock,	li
Time used,	li
Times of Observations for each Instrument,	li
Initials of Observers for each Hour on the Term-days,	lii
How to obtain the Absolute Declination from the Observations,	lii
Remarks on the Reductions and Abstracts,	lii
MAGNETICAL OBSERVATIONS—	
DAILY OBSERVATIONS OF MAGNETOMETERS,	2
TERM-DAY OBSERVATIONS OF MAGNETOMETERS,	22
EXTRA OBSERVATIONS OF MAGNETOMETERS,	50
OBSERVATIONS OF MAGNETIC DIP,	62
OBSERVATION OF ABSOLUTE HORIZONTAL INTENSITY,	66
METEOROLOGICAL OBSERVATIONS—	
DAILY METEOROLOGICAL OBSERVATIONS,	68
TERM-DAY AND EXTRA METEOROLOGICAL OBSERVATIONS,	110
REMARKS ON THE WEATHER,	118
ABSTRACTS OF THE RESULTS OF THE MAGNETICAL OBSERVATIONS—	
ABSTRACTS FOR THE MAGNETIC DECLINATION,	136
ABSTRACTS FOR THE HORIZONTAL FORCE,	140

CONTENTS.

v

	PAGE
ABSTRACTS FOR THE VERTICAL FORCE,	145
ABSTRACTS FOR DISTURBANCES,	152
ABSTRACTS FOR THE MAGNETIC DIP,	154
ABSTRACTS FOR THE TOTAL INTENSITY,	156
 ABSTRACTS OF THE RESULTS OF THE METEOROLOGICAL OBSERVATIONS—	
ABSTRACTS FOR THE BAROMETER,	158
ABSTRACTS FOR THE THERMOMETERS,	161
ABSTRACTS FOR THE AQUEOUS VAPOUR IN THE ATMOSPHERE,	162
ABSTRACT FOR THE FORCE OF WIND,	164
ABSTRACT FOR THE QUANTITY OF CLOUDS,	164
ABSTRACT FOR THE RAIN GAUGES,	165

ERRATA.

Introduction, page ix., foot-note, for simultaneous at read simultaneous observations at.

— — x., line 6, for Magnetometers read Magnetometers.

— — xxv., line 5, for $\cos v + \beta$ read $\cos (v + \beta)$.

Enter under No. 34, page xxxi. Introduction, the following :—

The effect of the Declination magnet on the Bifilar magnet is zero ; the effect of the Balance magnet N. pole E. on the Bifilar magnet is -3.15 Sc. div. This correction has not been applied to the observations.

Enter before Table 15, page xxxv. Introduction :—

The relative moments of the three magnets were determined by placing their centres successively on the same point at right angles to a spare magnet suspended in the Declinometer box and observing the deflections ; the following are their ratios—

$$\text{Declination} : \text{Bifilar} : \text{Balance} = 1.000 : 0.828 : 0.185.$$

Introduction, page xxiv., line 16, and page xl., line 27, for K read k.

— — xlvi., last line of Table 22, for 21 read 71.

Sept. 26^d 23^h 1841, page 4, Balance Thermometer, for 5.13 read 51.3.

Aug. 6^d 7^h 1842, — 58, for 29.43 read 129.43.

Oct. 29^d 20^h 1841, — 74, transpose the observations under Max. and Min.

July 27^d 20^h 1842, — 93, for 6.68 read 66.8.

— 100, carry foot-note to page 101.

Introduction, page lii., No. 79, for 24° read 23°.

PREFACE.

AMONGST the various Systems of Observation undertaken in 1839 by the British and other Governments, by the East India Company, and by private enterprize, for the advancement of our knowledge of Terrestrial Magnetism, none were directed to any point in Scotland; although this country, from its extreme north-westerly position in Europe, had been regarded by Professor GAUSS, the originator of this new movement in Science, as one of the most interesting localities for Observation.

General Sir THOMAS MAKDOUGALL BRISBANE, President of the Royal Society of Edinburgh, undertook to supply, at his own expense, the deficiency thus occasioned; and instituted, at his residence of Makerstoun, in Roxburghshire, a Magnetical Observatory on a scale similar to that of the Public Establishments, and of which a detailed account will be found in the Introduction to this volume of the Observations.

The personal establishment, originally confined to one observer, Mr E. RUSSELL, with occasional assistants, was gradually extended, under the superintendance of Mr J. A. BROUN, to three permanent observers, who, it is believed, have carried on as extensive a course of observation as it is possible for that number of individuals to perform, with the additional labours of reducing them and superintending the Press.

Sir THOMAS BRISBANE having expressed his wish that the Observations at the Makerstoun Observatory should appear in the Transactions of the Royal Society of Edinburgh, and be distributed along with them to the Fellows, both Ordinary and Foreign, the Council of the Royal Society willingly acceded to the proposal, and desired to mark their sense of the national importance of Sir THOMAS BRISBANE'S undertaking by contributing from the Funds of the Society towards the expense of publication.

The present volume, forming the Seventeenth of the Society's Transactions, is the First of the Makerstoun Observations.

JAMES D. FORBES, *Sec. R.S. Ed.*

GENERAL SIR T. M. BRISBANE takes this opportunity of acknowledging the obligation which he feels himself under to PROFESSOR FORBES, for his advice on the formation and continuance of the Makerstoun Observatory.

MAKERSTOUN MAGNETIC OBSERVATORY. *PLATE I. Royal Soc. trans. Edin. Vol. X. p. 6*

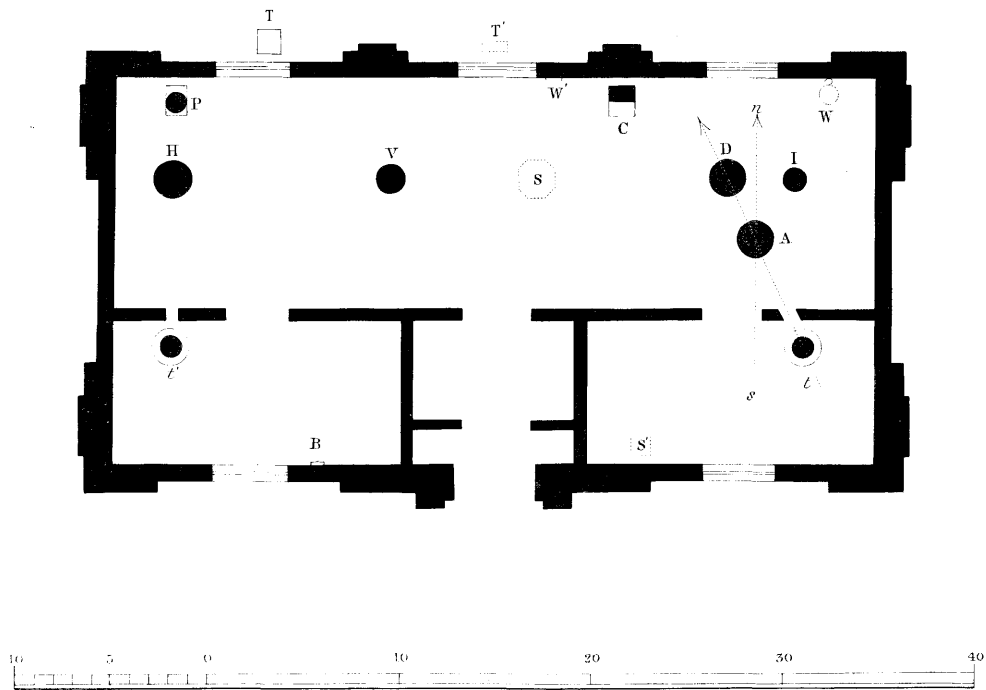
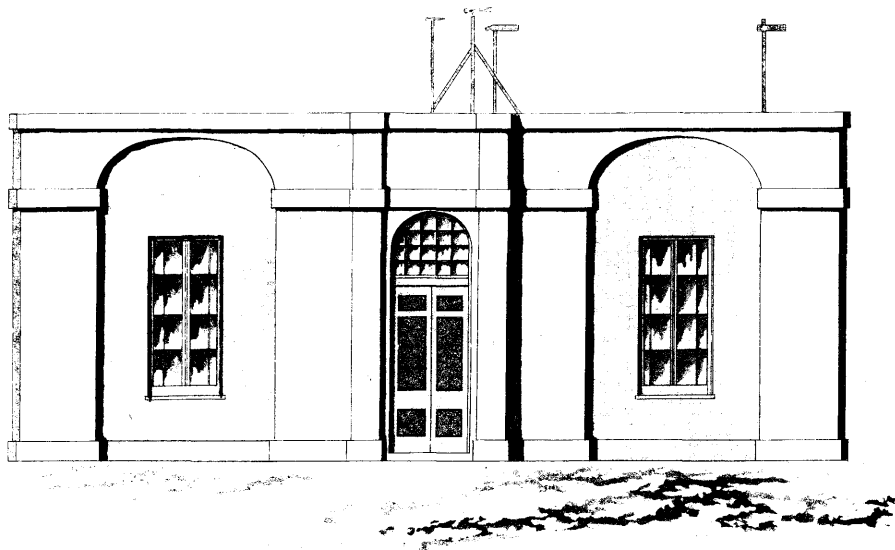

INTRODUCTION.

§ 1. DESCRIPTION OF THE OBSERVATORY, &c.

1. The Magnetic Observatory, Makerstoun, was erected in the beginning of 1841. The geographical co-ordinates are—

Latitude,	55° 34' 45" N.
Longitude,	0 ^h 10 ^m 3·5 ^s W.

Height of the cistern of the barometer above mean water at Berwick, 213 feet.*

The Magnetic Observatory is situate nearly on the summit of a ridge, which occupies the left or northern bank of the Tweed; being 540 feet distant from, and 80 feet above, that river.

The Astronomical Observatory is upon the highest part of the ridge, 140 feet due west of the Magnetic Observatory.

2. A fair horizon is seen from the Observatory hill, being bounded about 10 miles to the east by a slightly swelling ground, which to south-east seems to join the Cheviot Hills. The view is bounded about half-a-mile to south and south-west by a ridge, forming the right bank of the Tweed; about 500 feet to the south-west and north-west by masses of trees in the Makerstoun grounds; and from 1 to 3 miles to north-west, north, and north-east, by an elevated ridge, which forms to some extent the northern boundary of the valley of the Tweed.

From north, by the east to the south, the elevation of the horizon, with a slight exception, is under 2°; from north to north-west, increasing from 2° to 4°; from north-west to south-west, the tops of the trees are elevated from 5° to 8°; and from south-west to south the elevation is under 4°. The highest point of the Cheviots, which is 2656 feet above the level of the sea, is about 18 miles to the ESE.

3. The Observatory Hill, it is believed, is composed of felspathic trap. The Tweed, immediately to the south, and for a mile to the east and west, passes through this rock. It does not appear on any part of the hill; but seems, as far as the

* The height of a point in the Astronomical Observatory was obtained by connecting it with the levels made from Berwick to the opposite bank of the Tweed, for a projected railway from Berwick to Melrose. Barometrical observations at Holy Island and at Berwick by Sir T. M. BRISBANE, and at the Edinburgh Observatory by the late Professor HENDERSON, compared with simultaneous at Makerstoun, have verified the above determination.

opening for a foundation to the Observatory would shew, to be covered with masses of rolled pebbles, and boulders of greywacke and trap.

4. The Observatory is rectangular in its plan, 40 by 20 feet internally. It is formed of wood; copper nails were used; and iron carefully excluded from every part of the structure.

The pillars for the Magnetometers and Telescopes are of stone, from 22 inches to 19 inches in diameter, and placed upon excellent stone foundations, completely disconnected with the floor, or any part of the building. There are two windows to the south, with the door between; and three to the north, which open like folding doors.

5. By a reference to the plan and elevation, the following details will be understood:—

The dimensions of the principal apartment are, 40 feet long, 12 feet broad, and 12 feet high. The two ante-rooms are each 15 feet by 7.

The instruments, &c., are indicated in the plan as follows:—

- D, The Declinometer.
- t*, Its Reading Telescope.
- A, The Azimuth Circle and Transit.
- H, The Bifilar or Horizontal Force Magnetometer.
- t'*, Its Reading Telescope.
- P, A Pillar for a Collimator (not used).
- V, The Balance or Vertical Force Magnetometer.
- I, The Inclinator.
- B, The Standard Barometer.
- W, Adie's Anemometer.
- W', The Wind Vane Dial-Plate.
- T, The Thermometer Case after January 22. 1842.
- T', The Thermometer Case before January 22. 1842.
- C, The Mean Time Clock.
- S, The Copper Stove after Jan. 11. (?) 1842.
- S', The Copper Stove before Jan. 11 (?) 1842.
- n s*, The Astronomical Meridian.
- D *t*, The Magnetic Meridian.

The two Vanes to the right in the elevation are those for the direction and force of wind; the other two were added after 1842.

§ 2. PERSONAL ESTABLISHMENT, &c.

6. Mr RUSSELL was appointed by Sir THOMAS BRISBANE, in the spring of

1841, to conduct the Observatory, and resigned in April 1842. Mr RUSSELL is, therefore, only responsible for the observations up till that period.*

During term-days, Mr RUSSELL was assisted by Mr P. ADIE of Edinburgh, Mr HOGG of Kelso, and myself. After the April term 1842, Mr DODS, teacher of Makerstoun parish school, replaced Mr RUSSELL in the term observations ; and after the term 1842, Mr CHISHOLM, teacher of Maxton parish school, replaced Mr ADIE.

The Daily and Extra Observations, and Observations of Adjustment, till the end of April 1842, were made by Mr RUSSELL, assisted in some of the latter by me.

MAGNETICAL INSTRUMENTS.

§ 3. DECLINOMETER.

7. The Declination Magnetometer was obtained from GRUBB of Dublin. The Magnet is 15 inches long, $\frac{7}{8}$ ths of an inch broad, and $\frac{1}{4}$ th inch in thickness. It fits into a stirrup, whose two eyes receive an axle attached to the suspension thread. At the north extremity, it carries a scale divided on glass ; at the other, about 12 inches distant (its focal length), a lens of $1\frac{1}{4}$ inch diameter.

A marble slab cemented to the top of the Declinometer-Pillar, carries two copper tubes, which are connected at the top by a wooden tie, bearing the Torsion-Circle and Suspension Apparatus.

The Suspension Thread, formed of sixteen fibres of untwisted silk, is enclosed by a glass tube ; and the Magnet, with copper ring, for checking the vibrations, by a cylindrical box, with glass lids. There are two glazed apertures in the sides of the box, one to the north, where a small mirror throws light upon the glass scale, the other to the south between the Lens and the Reading Telescope.

The Reading Telescope is fixed to its pier. By noting the coincidences of the Scale divisions with the vertical wire at the eye-glass of the telescope, the variations of the position of the freely suspended magnet are obtained.

* Mr RUSSELL studied the methods of observing, &c., at Dublin, under Professor H. LLOYD, to whom he was also indebted for his attention to various difficulties which were subsequently met with. To Professor LLOYD I also owe my acknowledgments for his attention to several of my own communications.

Professor LLOYD, at the desire of Sir THOMAS BRISBANE, likewise examined the observations made by Mr RUSSELL and by myself till October 1842.

To Mr AIRY, Sir THOMAS BRISBANE'S thanks, and my own, are due, for the facilities afforded me at the Royal Observatory, Greenwich, in April 1842, of acquiring a knowledge of the methods adopted there. I should not omit to mention my obligations to Lieut.-Col. SABINE, and Professor FORBES, for their advice on some occasions.

8. Between the Magnetometer and Telescope piers is the pier of the Theodolite, used for determinations of the Absolute Declination. The Theodolite is by TROUGHTON; the circle is 15 inches in diameter, is divided to 5 minutes, and reads with the verniers to 5 seconds. There are three Verniers; by some accident, the circle has probably been slightly flattened on one side, as there the verniers enter rather too much upon the graduations. The error due to this, however, is small.

The lines of collimation of the Theodolite and Reading Telescopes coincide when the middle wire of the former is made to coincide with the vertical wire of the latter. The circle is retained in the same position on its pier, but the telescope is removed, except when required for Observations of Absolute Declination.

9. Following are the determinations of the data requisite in reducing the observations of the Declinometer.

10. Value of the Scale Divisions in angular measure.

A scale of 300 divisions was used in 1841, and of 500 divisions afterwards. The Magnet having been fixed on blocks, the middle wire of the Theodolite Telescope was made to coincide with various scale divisions. At each coincidence, one vernier of the circle was read.

TABLE 1.—Value of the Divisions of the Short Scale in the Declinometer during 1841.

Scale Division.	Theodolite Reading.	Scale Division.	Theodolite Reading.	Value of 100 Scale Divisions.
	° ' "		° ' "	° ' "
50	115 4 5	150	113 56 55	1 7 10
60	114 57 20	160	113 50 10	1 7 10
70	114 50 35	170	113 43 30	1 7 5
80	114 43 55	180	113 36 45	1 7 10
90	114 37 10	190	113 30 0	1 7 10
100	114 30 30	200	113 23 20	1 7 10
110	114 23 45	210	113 16 35	1 7 10
120	114 17 5	220	113 9 55	1 7 10
130	114 10 20	230	113 3 10	1 7 10
140	114 3 40	240	112 56 30	1 7 10
150	113 56 55	250	112 49 50	1 7 5

The mean value of 1 Scale division is 0'.6715.

TABLE 2.—Value of the Divisions of the Long Scale in the Declinometer during 1842.

Scale Division.	Theodolite Reading.	Scale Division.	Theodolite Reading.	Value of 100 Scale Divisions.
140	4 51 30.0	240	3 44 22.5	1 7 7.5
150	4 44 47.5	250	3 37 40.0	1 7 7.5
160	4 38 5.0	260	3 30 57.5	1 7 7.5
170	4 31 20.0	270	3 24 15.0	1 7 5.0
180	4 24 37.5	280	3 17 32.5	1 7 5.0
190	4 17 55.0	290	3 10 50.0	1 7 5.0
200	4 11 12.5	300	3 4 7.5	1 7 5.0
210	4 4 30.0	310	2 57 25.0	1 7 5.0
220	3 57 47.5	320	2 50 40.0	1 7 7.5
230	3 51 5.0	330	2 44 0.0	1 7 5.0
240	3 44 22.5	340	2 37 17.5	1 7 5.0
250	3 37 40.0	350	2 30 35.0	1 7 5.0
260	3 30 57.5	360	2 23 50.0	1 7 7.5

The mean value of 1 Scale division is 0'.6710.

11. Determination of the point of the scale at the magnetic axis of the bar, or the zero of the scale.

June 28. 1841. Magnet with short scale.

The torsion having been removed from the suspension thread, and the Reading Telescope fixed temporarily, readings were made, the magnet being direct and also inverted (the scale and lens below the magnet).

TABLE 3.—Reading of the Short Scale for the Magnetic Axis of the Declination Magnet.

Position of Magnet.	Scale Reading.	Mean of each alternate two.	Reading for Magnetic Axis.
Direct	140.3		
Inverted	159.1	139.9	149.50
Direct	139.6	159.3	149.45
Inverted	159.5	139.1	149.30
Direct	138.5	159.9	149.20
Inverted	160.3	137.8	149.05
Direct	137.1		

The mean reading for magnetic axis=149.3 Sc. div.

July 12 till 26. 1841. Effect of Bifilar and Balance Magnets (See Table 5), +0.3 Sc. div., corrected zero 149.0 Sc. div.

July 27 till Dec. 28. 1841. Effect of Bifilar and Balance Magnets (See Table 5), -0.3 Sc. div., corrected zero 149.6 Sc. div.

TABLE 4.—Reading of the Long Scale for the Magnetic Axis of the Declination Magnet.

Position of Magnet.	First Series.			Second Series.			Third Series.		
	Scale Reading.	Mean of each alternate two.	Reading for Magnetic Axis.	Scale Reading.	Mean of each alternate two.	Reading for Magnetic Axis.	Scale Reading.	Mean of each alternate two.	Reading for Magnetic Axis.
Inverted				256.5					
Direct	240.3			253.9	257.4	255.65	257.7		
Inverted	270.8	239.4	255.10	258.3	251.2	254.75	252.5	257.4	254.95
Direct	238.6	271.7	255.15	248.6	259.4	254.00	257.1	252.8	254.95
Inverted	272.6	237.9	255.25	260.5	251.4	255.95	253.1	257.6	255.35
Direct	237.1	273.6	255.35	254.1	256.4	255.25	258.1		
Inverted	274.5	237.6	256.05	252.3	258.1	255.20			
Direct	238.0			262.0					

Mean reading for magnetic axis, first series, 255.38
 second series, 255.13
 third series, 255.08

Mean of all the partial results, 255.21.

Correction for effect of Bifilar and Balance Magnets (Table 5) + 0.3 Sc. div.,
 adopted zero for 1842, 255.5 Sc. div.

12. Corrections to be applied to the observed positions of the Magnet to obtain the true declination.

13. Effect of the Balance and Bifilar Magnets on the Declination Magnet.

TABLE 5.—Effects of the Bifilar and Balance Magnets on the Declination Magnet.

N. end of Magnet.		Declination Reading.	Effect of Magnet.	
Bifilar.	Balance.		Bifilar.	Balance.
W.	E.	143.30		0.96
W.	W.	141.38	0.59	
E.	W.	142.57		0.95
E.	E.	144.47	0.70	
W.	E.	143.07		0.89
W.	W.	141.28		

Mean effect of Bifilar magnet on Declination magnet N. pole W. = -0.64 Sc. div.
 Balance N. pole E. = +0.94 Sc. div.
 Sum = +0.30 Sc. div.

After July 30. 1841, the north poles of the Bifilar and Balance Magnets were

to the west and east respectively: before that date they were in the reverse positions; consequently,

Joint effect of Bifilar and Balance Magnets on the Declination Magnet

before July 30. 1841 = - 0.30 Sc. div.

after = + 0.30 Sc. div.

14. Effect of the Copper Ring.

No observations were made to determine the error due to the copper ring till 1843. Previously, however, it had been placed over the Balance Magnet which indicates immediately the presence of the smallest quantity of iron; but the needle remained motionless.

In 1843, series of observations were made by reading the position of the Declination Magnet with the copper ring, in its place and away; the results were contradictory, being, for the effect of the ring, from - 1.82 to + 1.89 Sc. div., and lead to the belief that the effect must be small, if anything. The differences, it was presumed, were due to the generation of currents of air by lifting and shutting the box, to the changes of Declination occurring at the time, and to the greatly increased arc of vibration when the ring was removed.

In July 1843, after an extra Declinometer had been obtained, the results were equally contradictory, the differences were attributed to aerial currents as before, — the result of the best observations being nearly zero: the ring was therefore allowed to remain.

In October 1844, a careful series of observations was made with all the guards of double boxes, &c., when it was found from the consistent results, that the effect of the copper ring when in its usual position was equivalent to about - 1.0 Sc. div. It is now believed that the differences of the partial results obtained in 1843 were to some extent due to slight changes in the position of the ring in the different observations.*

The observations for the effect of the copper ring are reserved for the Introduction to the Volume for 1843. No correction has been applied for its effect in 1841 and 1842, as the position of the ring must have varied slightly during that period. It is believed that the effect must have been between about - 0.5.

15. Error of Collimation of the plane glass in the south side of the Declinometer-box.

No observation was made to determine this error till 1843. The magnet resting on blocks, the glass being in its usual position, reversed, and away, no difference could be detected in the scale readings.

* It should be remarked that the method of taking away and replacing, recommended in the Report of the Royal Society, does not seem that best fitted for determining the *existence* of a disturbing cause. During the Observations of 1844, it was found, that, by slightly varying the position of the ring, the effect might be much magnified, or reduced to zero.

16. The Suspension Thread and its Torsion Force.

The errors due to the torsion of the suspension thread are produced in two ways. First, by the magnet moving out of the plane of detorsion; secondly, by the variation of this plane, due generally to the varying humidity of the atmosphere.* The greatest change of declination from the mean has been within 2° ; the greatest correction for the torsion from this change would be within $8''$. The approximation of the line of detorsion to the magnetic meridian is probably seldom within 2° ; it is found on trial to have deviated from 5° to 40° from the magnetic meridian, and is so variable as to swallow up completely the changes from varying declinations.

If the magnet be deflected u' by turning the arms of the torsion circle w , the torsion is $w' - u'$, the ratio

$$\frac{u'}{w' - u'} = \frac{\text{coefficient of torsion force}}{\text{magnetic force} \times \text{moment of free magnetism}} = \frac{H}{F}$$

is the quantity by which the deviations of the magnet from the plane of detorsion should be multiplied, to obtain the decrements due to torsion force. If n be the observed deviation, $\left(1 + \frac{H}{F}\right)n =$ the true deviation.

The observations for the values of $\frac{H}{F}$ are given below; no use has been made of them for this correction, from the reason given above.

TABLE 6.—Values of $\frac{H}{F}$.

Date of the Observation.	$w=90^\circ$	$\frac{H}{F}$	Period to which the factor $1 + \frac{H}{F}$ applies.
	u'		
1841.			
July 8	4.63	0.00086	July 8—20
July 17	4.63	0.00086	
July 30	5.40	0.00100	July 26—Dec. 4
Dec. 28	4.91	0.00091	Dec. 22—Jan. 19
1842.			
March 3	5.36	0.00099	Jan. 21—May 24
June 6	4.74	0.00088	May 24—June 6
June 18	4.00	0.00075	June 7—June 26
June 21	4.29	0.00080	June 7—June 26
June 27	4.14	0.00077	June 27—July 18
Aug. 22	8.73	0.00162	July 20—Dec. 31

17. The second and most important error due to the torsion force, is from the varying plane of detorsion. Unless when the period and extent of change is known,

* A thick cotton cover was put over the whole Declinometer in January 1844, which seems to remedy this very much.

this can only be corrected practically. The magnet being removed, and the brass bar inserted (without any directive magnet), the extremities of the arc of vibration were observed; the marble slab beneath having radii drawn for every 5° , the deviation of the position of detorsion from the magnetic meridian is obtained, and the arms of the torsion-circle turned an equal number of degrees in the opposite direction. Much care and time was bestowed on these observations, so as to eliminate the torsion as completely as possible. Considerable annoyance was experienced from the breaking of the fibres of the first suspension-threads. They were formed of 16 fibres, as recommended in the Royal Society's Report. The necessity of removing the declination magnet during the observations of inclination, the difficulty of holding the thread with a force exactly equal to the weight of the magnet, and the consequent liability to strain, or, by loosening, to alter the disposition of the fibres, were frequent sources of torsion.

18. The principal facts relating to the suspension-threads are as follow:—

May 18. 1841. The suspension-thread was formed of 16 fibres of untwisted silk; the torsion was removed approximately for the observations of adjustment.

June 29. 1841. One of the fibres found broken; it was removed, and the torsion eliminated. The brass bar was suspended for several days, and was sometimes on one, sometimes on the other side of the magnetic meridian; attributed to moisture.

July 11. 1841. Before this date the torsion had been removed with much care.

July 20. 1841. Another fibre found broken; the loose part was removed without disturbing the thread. No mention is made of the torsion being removed; it is, therefore, probable that a considerable torsion existed during the term observations of July 22. 1841.

July 26. 1841. A new suspension-thread attached. Great care was taken to render the tension of each fibre as equal as possible: several threads were rejected in succession, until a satisfactory one was obtained. The brass bar was suspended for several days, and the torsion occasionally removed.

Dec. 4—8. 1841. The declination magnet was found resting on the copper ring, the suspension-roller being untwisted, and the thread cut at its contact with the ring. A new thread was prepared, and the screws of the roller tightened. As much care was taken in forming the thread, and removing the torsion, as on July 26.

Dec. 20. 1841. On Mr RUSSELL's return from Edinburgh, where he had been for a short time, the thread was found much stretched, bringing the stirrup into contact with the copper ring; it was wound up a little, and the plane of detorsion examined preparatory to the term-day, Dec. 22, 23. 1841.

Dec. 23. Noon, Gött. From the uniformity of the declination readings during several hours of the term-day, the box was lifted, and the lower part of the stirrup found grazing on the copper ring; the suspension-roller was quite tight; it must, therefore, have been due to the stretching of the thread. The observations of decli-

nation are not given, on this account, till noon, when the thread was wound up. The observations after are probably affected by a considerable torsion-force.

January 19^d 2^h. 1842. Two fibres of the suspension-thread found broken; they were removed, but the plane of detorsion had evidently varied to a considerable extent. During the following night and day (term-day), the thread broke away fibre by fibre; and though readings of the instrument were continued, they cannot be considered of much value. They are given from January 19^d 10^h till 20^d 6^h, and are corrected by -13.4 , an approximate reduction for torsion obtained from a comparison with the usual daily observations.

January 21. 1842. A new thread prepared; allowed to stretch for several days, when the magnet was suspended. The torsion eliminated, the circle reading 280° .

May 24. 1842. A fibre found broken, removed by cutting near the top and bottom ties.

May 26. A new thread prepared, formed of 20 fibres. A weight was attached to it, and suspended till required.

May 30^d 20^h. No observations of torsion were made lately. On removing the declination magnet, in order that the dip observation might be made, the brass bar which was inserted was generally caught by a wooden block; it was allowed to move freely to-day, when the bar went round about 400° , the motion opposite to that of the sun. The torsion-circle read, vernier A. 146° . The torsion was supposed to be about 180° . The arm of the torsion-circle was turned through nearly 90° , by mistake, instead of 180° ; torsion-circle reading, B. 235° . The magnet was replaced till the observation at 23^h, after which the brass bar was again inserted, and ultimately the torsion-circle left reading B. $354^\circ 55'$. After 5^h the brass bar was suspended until

May 31^d 19^h 30^m, when the arm of the torsion-circle was turned to B. $358^\circ 4'$.

June 2^d 5^h +. Torsion again tried, and the circle left reading B. $44^\circ 15'$.

June 3^d 5^h +. It was found, when the torsion-circle read B. $35^\circ 0'$, that the torsion was removed as nearly as possible. It is believed that, from various causes, the torsion was not completely eliminated till now. Upon examining the daily observations, it was evident that a marked change had taken place in the declination readings between May 16^d 20^h and 23^h, the period of the dip observation. There was no doubt but that the torsion had been induced at this time. It is almost certain that the brass bar must have gone round half a revolution before being checked by the wooden block; or, that being inserted in the *reverse* position, it had been *supposed* to have gone round and altered accordingly.

The breaking of a fibre May 24^d, and the probable existence of torsion previously, will account for the difference from 180° .

From the observations for the value of $\frac{H}{F}$ March 3^d and June 6^d, a torsion of 180° corresponds to a deflection of the magnet of 16.3 and 14.12 scale divisions, respectively.

The following are the corrections which have been applied to the observations of declination, on account of the estimated torsions; the first value of $\frac{H}{F}$ applying only to the observations before May 23^d 20^h.

Period.	Torsion.	Correction. Sc. Div.
May 16 ^d 23 ^h —23 ^d 5 ^h ,	180	+ 16·3
May 23 ^d 20 ^h —30 ^d 20 ^h ,	249	+ 19·5
May 30 ^d 23 ^h ,	160	+ 12·5
May 31 ^d 2 ^h —5 ^h ,	40	+ 3·2
May 31 ^d 20 ^h —June 2 ^d 5 ^h ,	37	+ 2·9
June 2 ^d 20 ^h —June 3 ^d 5 ^h ,	9	- 0·7

June 6^d 20^h. Two fibres found broken; they were cut off and the torsion removed.

June 20^d 21^h. Torsion tried; found to be 61° 30′.

June 26^d 20^h. Fibre broken; removed the torsion which was 173°.

June 28^d. The torsion is always determined and removed during the period of dip observations. For these determinations, see notes to the Daily Observations.

July 18^d 20^h. Fibre broken; the torsion was removed as nearly as possible for the day's observations.

July 19^d 5^h. The thread, prepared May 26^d, and having a brass weight suspended since then, was now inserted, the other having become weak. This thread was composed of 20 fibres. The torsion was completely eliminated this evening.

19. Errors from accidental sources.

It is believed that a small magnet intended to be placed in the brass bar to facilitate the elimination of torsion from the suspension thread of the declinometer, but which was never used, had been lying in the writing-desk between July 1841 and March 29. 1843. The position of the desk was to the east of the reading telescope of the declinometer, except on term-days, when, for convenience, it was moved to a position nearly midway between the piers of the Declination and Balance magnetometers.

In the usual position of the desk, the greatest effect of the small magnet on the declination might be from + 0'2 to - 0'2; and during term-days from + 1'1 to - 1'1. It is probable that the magnet remained in the same position in the desk for a long period.

The effect would be constant for each term, and from term-day till term-day.

ABSOLUTE DECLINATION.

20. The absolute declination is determined in the following manner:—

The middle wire of the theodolite telescope is brought to coincide with the

vertical wire of the reading telescope ; the three verniers of the horizontal circle are then read ; the telescope is turned until its middle wire coincides with the vertical line on the north meridian mark of the western transit in the Astronomical Observatory, and the verniers are again read.

In order to obtain the reading of the horizontal circle for the astronomical meridian, the theodolite telescope is placed as nearly in the meridian as possible, and being accurately levelled, the time of the sun's transit is observed by the magnetic observatory clock ; the sun's transit was also observed with the transit telescope in the astronomical observatory, and the clocks being compared, the true time of transit, by the magnetic observatory clock, is obtained. The difference, if any, between the true and observed times of transit, is due to error of azimuth ; the latter, being very small, is obtained from the former in multiplying by the factor

$$\frac{\cos. \text{ sun's declin.}}{\cos. \text{ sun's alt.}}$$

21. If A be the difference of the horizontal circle readings for the fixed telescope and the north mark, Z the azimuth of the north mark, and D the angle contained by the line of collimation of the fixed telescope, and the magnetic axis of the declination bar at any instant, D being equal to the observed reading, at that instant *minus* the scale reading at the magnetic axis of the bar in angular measure, the true declination will be

$$180^\circ - A + Z = D$$

The following tables contain the observations for the value of Z and A :—

TABLE 7.—Determinations of the Values of Angle A.

Date.	Readings of Horizontal Circle								Angle A.
	For Declination Telescope.				For North Mark.				
	Verniers.			Mean.	Verniers.			Mean.	
	A.	B.	C.		A.	B.	C.		
1841.	' "	' "	' "	° ' "	' "	' "	' "	° ' "	° ' "
Aug. 7	55 10.0	54 15.0	54 40.0	233 54 41.7	49 15.0	49 55.0	49 30.0	77 49 33.7	23 54 52.0
Sept. 4	44 50.0	45 20.0	44 50.0	233 45 0.0	40 5.0	40 5.0	40 0.0	77 40 3.3	23 55 3.3
Sept. 18	49 0.0	48 15.0	48 10.0	113 48 28.3	43 30.0	43 40.0	43 25.0	317 43 31.7	23 55 3.4
Sept. 28	48 45.0	48 10.0	48 25.0	293 48 26.7	43 50.0	43 25.0	43 10.0	317 43 28.3	23 55 1.6
Oct. 18	48 50.0	48 15.0	48 25.0	293 48 30.0	43 55.0	43 35.0	42 55.0	317 43 28.3	23 54 58.3
Nov. 2	48 50.0	48 20.0	48 15.0	293 48 28.3	43 50.0	43 35.0	42 55.0	317 43 26.7	23 54 58.4
Nov. 23	46 50.0	46 40.0	46 25.0	293 46 38.3	40 45.0	41 50.0	41 30.0	317 41 21.7	23 54 43.4
Dec. 3	48 15.0	48 7.5	47 55.0	293 48 5.8	42 10.0	43 10.0	43 0.0	317 42 46.7	23 54 40.9
1842.									
Jan. 18	50 15.0	50 0.0	49 50.0	293 50 1.7	40 30.0	40 15.0	39 40.0	317 40 8.3	23 50 6.6
Feb. 1	52 20.0	51 50.0	52 35.0	293 52 15.0	42 50.0	42 30.0	41 50.0	317 42 23.3	23 50 8.3
Feb. 15	49 12.5	48 50.0	49 5.0	293 49 2.5	39 50.0	39 22.5	39 10.0	317 39 27.5	23 50 25.0
Feb. 28	48 55.0	48 45.0	48 40.0	293 48 50.0	39 30.0	39 5.0	38 40.0	317 39 5.0	23 50 15.0
Mar. 12	49 30.0	49 10.0	49 25.0	293 49 21.7	40 10.0	39 50.0	39 10.0	317 39 43.3	23 50 21.6
Mar. 26	49 10.0	48 55.0	49 10.0	293 49 5.0	39 50.0	39 35.0	38 50.0	317 39 25.0	23 50 20.0
Apr. 9	49 25.0	49 10.0	49 30.0	293 49 21.7	40 10.0	39 45.0	39 15.0	317 39 43.3	23 50 21.6
Apr. 27	52 25.0	52 5.0	52 40.0	293 52 23.3	43 0.0	42 52.5	42 10.0	317 42 40.8	23 50 17.5
July 13	52 40.0	52 45.0	53 40.0	233 53 1.7	43 30.0	42 50.0	43 7.0	77 43 9.0	23 50 7.3
July 13	52 40.0	52 30.0	53 20.0	233 52 50.0	43 20.0	42 50.0	42 55.0	77 43 1.7	23 50 9.5
Aug. 16	52 40.0	52 25.0	53 6.6	233 52 43.9	43 12.5	42 52.5	43 8.0	77 43 4.3	23 50 20.4
Aug. 16	52 40.0	52 42.0	53 10.0	233 52 50.7	42 12.0	42 55.0	43 10.0	77 43 5.7	23 50 17.7
Sept. 17	52 45.0	53 12.5	52 42.5	233 52 55.0	43 25.0	43 0.0	43 10.0	77 43 11.7	23 50 16.7
Oct. 31	52 20.0	52 11.0	52 50.0	233 52 27.0	42 49.0	42 37.5	42 40.0	77 42 42.2	23 50 15.2
Oct. 31	52 9.0	52 2.5	52 45.0	233 52 18.8	42 41.5	42 27.5	42 39.0	77 42 36.0	23 50 16.2
Dec. 24	52 10.0	52 16.5	52 52.5	233 52 26.3	43 5.0	42 42.5	42 37.5	77 42 48.3	23 50 22.0

The following mean values of Angle A were adopted :—

August 7—November 23. 1841, Angle A = 23° 54' 57".2.
 January 18, and February 1. 1842, = 23° 50' 7".5.
 February 15—December 24. 1842, = 23° 50' 19".3.

The observation for the value of A, Dec. 23. 1841, has not been used in taking the mean for 1841.

Between Dec. 3. 1841 and Jan. 13. 1842, the pillar of the reading telescope of the Declinometer was shifted. There is no register of the period at which this was done, but it is believed to have been at the same period at which the long scale was inserted in place of the short one on the Declination Magnet, or Dec. 28–9. 1841.

The observations of Angle A, Jan. 18. and Feb. 1. 1842, have been separated from the others for that year, as they are considerably less, and the difference may have been due to some cause unrecorded.

In the observations after July 13. 1842, the reading for each vernier is the mean of several made with different lights. The light was generally projected on the verniers in the direction of the divisions, by means of a mirror.

The two observations, July 13. 1841 and the first on Aug. 16, were rejected in taking the mean, as they were noted as having been made with bad lights, when the coinciding divisions could not be well determined. Retaining the observation of Dec. 3. 1841, the mean value of Angle A for 1841 = 23° 54' 55".2. Using the observations rejected in 1842, the mean value after Feb. 1842 = 23° 50' 19".1".

TABLE 8.—Observations for the Value of the Angle Z.

Date.	Readings of Horizontal Circle.			Sun's Lamb.	Wires.					Observatory Clock Time.		Observed <i>azims</i> True Transist.	Error of Azimuth.	Reading of Horizontal Circle.				Angle Z.			
	Verniers.				Times of Sun's Transist.					Transist of Centre, Mean of reductions to Wire III.	h. m. s.			h. m. s.	Meridian.				For North Mark.		
	A.	B.	C.		I.	II.	III.	IV.	V.						h. m. s.	h. m. s.	A.		B.	C.	Mean.
Jan. 17	45.0	45.0	40.0	319 17 43.3	I. 23.5 II. 51.3	I. 20.3 II. 59.5	I. 25.7 II. 52.7	I. 20.5 II. 52.7	I. 20.5 II. 52.7	I. 10:58 II. 35:03	I. 0 9:85 II. 0 33:21	+ 0.73 + 1.82	+ 0 10.5 + 0 26.9	319 17 32.8 319 17 44.8	40 20.0 40 30.0	40 5.0 40 15.0	39 25.0 39 40.0	137 39 56.6 137 40 8.3	1 37 36.2 1 37 36.5		
Jan. 18	12.5	10.0	12.5	319 18 11.7	I. 48.0 II. 37.3	I. 44.5 II. 33.7	I. 44.5 II. 33.7	I. 44.5 II. 33.7	I. 44.5 II. 33.7	I. 0 35:03 II. 42:85	I. 0 33:21 II. 1 40:83	+ 1.82 + 2.02	+ 0 26.9 + 0 29.4	319 17 44.8 319 18 0.6	40 30.0 40 50.0	40 15.0 40 25.0	39 40.0 39 55.0	137 40 8.3 137 40 23.3	1 37 36.5 1 37 37.3		
Jan. 21	30.0	20.0	40.0	319 18 30.0	I. 55.5 II. 18.3	I. 55.5 II. 18.3	I. 55.5 II. 18.3	I. 55.5 II. 18.3	I. 55.5 II. 18.3	I. 1 42:85 II. 5:37	I. 1 40:83 II. 4 38.4	+ 2.02 + 1.73	+ 0 29.4 + 0 26.0	319 18 0.6 319 20 5.7	40 50.0 42 55.0	40 25.0 42 35.0	39 55.0 41 50.0	137 40 23.3 137 42 23.3	1 37 37.3 1 37 42.4		
Feb. 1	20.0	15.0	60.0	319 20 31.7	I. 26.5 II. 42.0	I. 22.0 II. 37.5	I. 22.0 II. 37.5	I. 22.0 II. 37.5	I. 22.0 II. 37.5	I. 4 29:77 II. 56:00	I. 4 29:46 II. 4 51:57	+ 0.31 + 4.43	+ 0 4.7 + 1 7.1	319 20 8.6 319 19 39.6	42 47.5 42 20.0	42 35.0 42 0.0	41 50.0 41 20.0	137 42 24.2 137 41 53.3	1 37 44.4 1 37 46.3		
Feb. 3	7.5	7.5	25.0	319 20 13.3	I. 53.0 II. 35.3	I. 48.5 II. 35.3	I. 48.5 II. 35.3	I. 48.5 II. 35.3	I. 48.5 II. 35.3	I. 4 56:00 II. 41:91	I. 4 51:57 II. 4 40:50	+ 4.43 + 1.41	+ 1 7.1 + 0 22.0	319 20 8.6 319 16 59.7	42 20.0 39 50.0	42 0.0 39 22.5	41 20.0 39 10.0	137 41 53.3 137 39 27.5	1 37 46.3 1 37 32.2		
Feb. 5	45.0	35.0	60.0	319 20 46.7	I. 54.0 II. 42.0	I. 48.5 II. 37.5	I. 48.5 II. 37.5	I. 48.5 II. 37.5	I. 48.5 II. 37.5	I. 4 42:77 II. 38:04	I. 4 42:34 II. 4 44:14	+ 0.43 - 11.10	+ 0 6.8 - 2 57.2	319 17 9.9 319 20 15.5	39 55.0 42 55.0	39 35.0 42 47.5	39 5.0 42 10.0	137 39 31.7 137 42 37.5	1 37 38.2 1 37 38.0		
Feb. 15	20.0	25.0	25.0	319 17 21.7	I. 43.0 II. 29.3	I. 37.3 II. 23.0	I. 37.3 II. 23.0	I. 37.3 II. 23.0	I. 37.3 II. 23.0	I. 4 43:43 II. 28:92	I. 4 43:03 II. 4 39:49	+ 0.40 - 10.57	+ 0 6.5 - 2 50.4	319 20 13.5 319 20 17.1	42 55.0 42 55.0	42 45.0 42 45.0	42 10.0 42 15.0	137 42 36.7 137 42 38.3	1 37 36.8 1 37 38.8		
Feb. 16	20.0	10.0	20.0	319 17 16.7	I. 41.0 II. 54.5	I. 35.0 II. 49.0	I. 35.0 II. 49.0	I. 35.0 II. 49.0	I. 35.0 II. 49.0	I. 4 40:71 II. 38:04	I. 4 37:40 II. 4 44:14	+ 3.31 - 11.10	+ 0 53.4 - 2 57.2	319 20 6.6 319 20 15.5	42 50.0 42 55.0	42 40.0 42 47.5	42 5.0 42 10.0	137 42 31.7 137 42 37.5	1 37 34.9 1 37 38.0		
Feb. 18	20.0	10.0	25.0	319 17 18.3	I. 46.4 II. 22.0	I. 40.2 II. 14.9	I. 40.2 II. 14.9	I. 40.2 II. 14.9	I. 40.2 II. 14.9	I. 4 34:62 II. 54:55	I. 4 34:69 II. 2 55:56	- 0.07 - 1.01	- 0 1.2 - 0 16.8	319 16 44.5 319 16 45.1	39 30.0 39 30.0	39 0.0 39 5.0	38 40.0 38 40.0	137 39 3.3 137 39 5.0	1 37 41.2 1 37 40.1		
Feb. 19	15.0	10.0	35.0	319 20 20.0	I. 43.0 II. 29.3	I. 37.3 II. 23.0	I. 37.3 II. 23.0	I. 37.3 II. 23.0	I. 37.3 II. 23.0	I. 4 43:43 II. 28:92	I. 4 43:03 II. 4 39:49	+ 0.40 - 10.57	+ 0 6.5 - 2 50.4	319 20 13.5 319 20 17.1	42 55.0 42 55.0	42 45.0 42 45.0	42 10.0 42 15.0	137 42 36.7 137 42 38.3	1 37 36.8 1 37 38.8		
Feb. 22	25.0	15.0	40.0	319 17 26.7	I. 41.0 II. 54.5	I. 35.0 II. 49.0	I. 35.0 II. 49.0	I. 35.0 II. 49.0	I. 35.0 II. 49.0	I. 4 40:71 II. 38:04	I. 4 37:40 II. 4 44:14	+ 3.31 - 11.10	+ 0 53.4 - 2 57.2	319 20 6.6 319 20 15.5	42 50.0 42 55.0	42 40.0 42 47.5	42 5.0 42 10.0	137 42 31.7 137 42 37.5	1 37 34.9 1 37 38.0		
Feb. 23	55.0	50.0	75.0	319 21 0.0	I. 46.4 II. 22.0	I. 40.2 II. 14.9	I. 40.2 II. 14.9	I. 40.2 II. 14.9	I. 40.2 II. 14.9	I. 4 34:62 II. 54:55	I. 4 34:69 II. 2 55:56	- 0.07 - 1.01	- 0 1.2 - 0 16.8	319 16 44.5 319 16 45.1	39 30.0 39 30.0	39 0.0 39 5.0	38 40.0 38 40.0	137 39 3.3 137 39 5.0	1 37 41.2 1 37 40.1		
Feb. 24	40.0	40.0	50.0	319 16 43.3	I. 46.4 II. 22.0	I. 40.2 II. 14.9	I. 40.2 II. 14.9	I. 40.2 II. 14.9	I. 40.2 II. 14.9	I. 4 34:62 II. 54:55	I. 4 34:69 II. 2 55:56	- 0.07 - 1.01	- 0 1.2 - 0 16.8	319 16 44.5 319 16 45.1	39 30.0 39 30.0	39 0.0 39 5.0	38 40.0 38 40.0	137 39 3.3 137 39 5.0	1 37 41.2 1 37 40.1		
Feb. 28	25.0	25.0	35.0	319 16 28.3	I. 6.2 II. 32.5	I. 59.8 II. 25.3	I. 59.8 II. 25.3	I. 59.8 II. 25.3	I. 59.8 II. 25.3	I. 2 54:55 II. 1 01.0	I. 2 55:56 II. 1 01.0	- 1.01 - 1.01	- 0 16.8 - 0 16.8	319 16 45.1 319 16 45.1	39 30.0 39 30.0	39 5.0 39 5.0	38 40.0 38 40.0	137 39 5.0 137 39 5.0	1 37 40.1 1 37 40.1		

Mean value of Angle Z = 1 37 38.8.

The following are the mean values of Angle A + Z adopted:—

- August 7—November 23. 1841 Angle A + Z = 25 32 36.0 used during 1841.
- January 18—February 1. 1842 25 27 46.3 used from Jan. 1 till Feb. 5. 1842.
- February 15—December 24. 1842 25 27 58.1 after Feb. 5. 1842.

Tables have been formed from these values, and the known values of the scale divisions, by which the readings in scale divisions have been reduced to angular measure.

22. Mr RUSSELL had determined the time of vibration of the declination magnet to be nearly 18 seconds, which was accordingly used in the observations.

The results below were obtained afterwards.

June 24 ^d 20 ^h 1842,	60	vibrations	give	a	mean	of	17 ^s ·89
July 16	5	...	22	17·80
Sept. 24	6	...	22	17·84
Oct. 8	3	...	50	17·82

23. The points of the scale which coincided with the vertical wire of the reading telescope, were noted 18^s before the minute of observation, at the minute, and 18^s after the minute. The readings at these periods being a , b , and c ; the mean is deduced by the formula $\frac{a + 2b + c}{4}$.

The observations of declination in this volume are given in minutes and decimals. The absolute declination is obtained from them by adding 23° 20'; or, if 100' be subtracted, the absolute declination is obtained by prefixing 25°.

§ 4. BIFILAR OR HORIZONTAL FORCE MAGNETOMETER.

24. This instrument is also by GRUBB of Dublin, and is similar, in its general construction, to the Declinometer.

The magnet, whose dimensions are 15 inches, $\frac{7}{8}$ inch, and $\frac{1}{4}$ inch, is placed in a stirrup, which carries below it the lens and scale connected by a tube, forming a close collimator; the axle of a grooved wheel fits into the suspension eyes of the stirrup, the whole being borne by a silver wire passing round the grooved wheel, and having its two extremities fixed to a suspension roller; the roller is supported by the torsion circle, which also bears beneath the roller a micrometer-headed screw, right-handed where it meets one wire (or portion of the wire), and left-handed where it meets the other. The screw is for the purpose of making the distance of the wires at the top equal to that at the grooved wheel.

25. In the adjustment of the instrument, the magnet is forced to a position at right angles to the magnetic meridian, by turning the arms of the torsion circle. As, in forcing the magnet from the meridian, the upper extremities of the wire will move through a greater angle than the lower extremities, the wires will be no longer vertical, and the magnet and appendages will be raised; the forces producing equilibrium, therefore, being the weight suspended endeavouring to attain the lowest point, and the horizontal component of the earth's magnetic intensity acting on the free magnetism of the bar.

26. If v be the excess of angular motion of the arms of the torsion circle or upper extremity of the wires over u , that of the lower extremities or magnetic bar in moving the latter from the meridian, the equation of equilibrium is

$$m X \sin u = W \frac{a^2}{l} \sin v,$$

m , X , W , a , and l , being respectively the magnetic moment of the bar, the horizontal component of the earth's magnetic force, the weight suspended, the interval and length of the wires.

By differentiation and division, the following equation is obtained, $u = 90^\circ$.

$$\frac{\Delta X}{X} = n \alpha \cot v + t(Q + 2e - e'),$$

n being the number of scale divisions from the zero, or reading when $u = 90^\circ$; α the arc value in parts of radius of one scale division; t the number of degrees above the zero of temperature; Q the value of $\frac{\Delta m}{m}$ for 1° ; e and e' the coefficients of expansion for the brass of the grooved wheel, and silver of the wires.

27. The tables of abstracts, in parts of the whole horizontal force, are computed by this formula. The values of

$$\begin{aligned} K &= \alpha \cot v, \text{ and} \\ q &= Q + 2e - e', \end{aligned}$$

are given No. 32.

28. During considerable disturbances, the collimator scale, which contains too small an angle, goes out of the field of the reading telescope. In this case it has been found necessary to turn the arms of the torsion circle until it again appears; without this it has happened that the greater part of a disturbance would have been lost. As there was some doubt that turning the torsion circle after adjustment might affect the instrument injuriously, experiments were made in 1842, during periods of slight change, which shewed, after turning the torsion circle a few degrees in different directions, that on recurring to the original value of v , the scale readings were unaltered.

In altering v , the value of the scale divisions, and the unit of force are also changed; it is therefore necessary to reduce the observations to a common unit. Let β be the small angle through which the torsion circle is turned, then v becomes $v' = v \pm \beta$. If $m X = F$, $W \frac{a^2}{l} = G$, the equations of equilibrium for the two positions are

$$F = G \sin v \quad u = 90^\circ. \quad (1.)$$

$$F' = \frac{G \sin (v' \pm \Delta v')}{\cos \Delta v'}. \quad (2.)$$

Subtracting (1) from (2), and dividing by (1),

$$\frac{F' - F}{F} = \frac{\Delta F}{F} = \frac{\sin v' - \sin v}{\sin v} \pm \frac{\cos v'}{\sin v} \Delta v'.$$

If n be the number of scale divisions from the zero or reading for $u = 90^\circ$, when $v' = v \pm \beta$, N the number from the zero, for the same force, if v had its normal value, then

$$N = \frac{\sin v' - \sin v}{\alpha \cos v} \pm n \frac{\cos v'}{\cos v},$$

or adapting the first constant to logarithmic computation,

$$\begin{aligned} &= \frac{2 \sin \frac{\beta}{2}}{\alpha \cos v} \cos \left(v + \frac{\beta}{2} \right) + n \frac{\cos v + \beta}{\cos v} \\ &= A + n B. \end{aligned}$$

β is considered negative when v is diminished, and n is negative when the reading is below the zero.

The following are the values of β , A , and B , used in reducing the extra observations :—

TABLE 9.—Constants for the Reduction of Observations after altering the reading of the Torsion Circle.

Periods to which the quantities apply.						Angle v .	β .	A.	B.		
1841.											
	d.	h.	m.	d.	h.	m.	°	'			
Sept.	7	23	0—30	5	0		65	2	+ 0 50	+ 43.8	0.969
Sept.	25	4	0—25	5	20		65	52	+ 6 0	+ 282.4	0.761
	25	5	20—25	5	25		65	52	+ 4 0	+ 196.8	0.842
	25	5	25—25	5	40		65	52	+ 3 0	+ 150.8	0.882
	25	5	40—25	5	50		65	52	+ 5 0	+ 240.7	0.802
	25	5	50—25	6	25		65	52	+ 3 0	+ 150.8	0.882
	25	6	25—25	7	0		65	52	+ 2 0	+ 102.6	0.921
Oct.	6	20	0—19	20	0		69	6	- 0 50	- 45.3	1.038
1842.											
July	2	10	16—	2	13	0	69	6	- 2 22.5	- 133.7	1.108

ADJUSTMENTS.

29. The scale of the collimator contains 280 divisions with the graduation at 300. Determination of the angular value of 1 scale division :—

TABLE 10.—Value of the Biflar Magnetometer Scale Divisions.

Scale Division.	Theodolite Reading.	Scale Division.	Theodolite Reading.	Value of 50 Scale Divisions.
	° ' "		° ' "	° ' "
110	5 27 40	160	4 31 30	0 56 10
120	5 16 25	170	4 20 15	0 56 10
130	5 5 10	180	4 9 0	0 56 10
140	4 53 55	190	3 57 45	0 56 10
150	4 42 45	200	3 46 35	0 56 10
160	4 31 30	210	3 35 20	0 56 10

Mean value of 1 Scale Division 1'.1233.

30. *June 23.* 1841. A number of observations were made, following the directions of the Report of the Royal Society, which were rendered valueless by various accidental causes, but chiefly from an extreme idea of the extent of accuracy to be expected in the adjustments, and probably from the changes in the horizontal force being considerable at the time. The collimator was also sometimes moved accidentally during the adjustment.

A silver wire having been prepared, and the extremities attached to the suspension roller, the grooved wheel, No. 8, whose diameter = 0.409 inch, was inserted, and the stirrup with a brass weight appended. The zero of the micrometer head of the biflar screw being equivalent to an interval of half an inch, and each of its divisions = 0.0005194 inch, $\frac{0.500 - 0.409}{0.0005194} = 175$ was the number of divisions through which the micrometer head was turned back, in order to equalize the intervals above and below.

The weight being now removed, and the magnet inserted, it was found necessary to turn the torsion circle through 159° , to deflect the magnet to a position at right angles to the meridian. From eq. (1) $\frac{F}{G} = \sin v = \cos 159^\circ = 0.93$.

This wheel was retained.

The magnet was nearly in the magnetic meridian when the torsion circle read $268^\circ 54'$; the scale reading was then 118.0.

The magnet was removed and the brass weight suspended, when the scale read 89.0. Approximately equation (1) becomes $F u = G v$, whence $u + v = \left(\frac{G}{F} + 1\right) v$
 $v = (118 - 89) 1'.1233 = 33'$.

$$u + v = \frac{1.93}{0.93} \times 33' = 67'$$

The arms of the torsion circle were turned $1^\circ 7'$. Torsion circle reading $270^\circ 1'$
 Scale reading with weight attached, 149.

. magnet . . . 152.

June 24^d. After several trials, the plane of detorsion and the magnetic meridian were found to coincide when the torsion circle read $269^{\circ} 56'$.

The weight being attached, the arm of the torsion circle was turned 90° —its reading being then $359^{\circ} 56'$; the collimator was turned by its independent motion till the scale read 130^{div} . The magnet being substituted, N. pole East, it was found requisite to turn the arms of the torsion circle $70^{\circ} 4'$, to make the scale again read 130^{div} .

Magnet at right angles to magnetic meridian. Scale reading 130^{d} . Torsion circle reading $70^{\circ} 0'$.

$$v = 70^{\circ} 4' \quad \alpha = 1 \cdot 1233 = \cdot 0003268 \text{ in parts of radius} \quad k = \alpha \cot v = 0 \cdot 000185$$

In this position of the magnet, N. pole towards the east, increasing scale readings indicated decreasing force, this has been reversed in the reduced observations, which were *subtracted* from a constant quantity.

July 29^d. The bifilar was readjusted, the N. pole of the magnet being directed to the west, in order that increasing readings may indicate increasing force.

The plane of detorsion and magnetic meridian coincided when the torsion circle read $269^{\circ} 52'$. The brass weight being suspended, the arms of the torsion circle were turned 90° ; circle reading $179^{\circ} 52'$. The collimator scale was made to read $153 \cdot 3^{\text{div}}$. The weight being removed, and the magnet substituted, the arms of the torsion circle were turned $65^{\circ} 2'$; circle reading $114^{\circ} 59'$; the scale reading was 153^{div} .

$$v = 65^{\circ} 2', \quad k = 0 \cdot 0001185$$

Sept. 7^d. The readings of the scale being always considerably above the zero division (153), the arms of the torsion circle were turned $50'$; the circle reading $114^{\circ} 0'$.

$$v = 65^{\circ} 52', \quad k = 0 \cdot 0001464.$$

Mr RUSSELL could not make any conjecture as to the difference between the values of v , obtained June 24^d and July 29^d. Professor LLOYD, with whom he communicated, suggested a twist in the wires as the probable cause; this Mr RUSSELL found to be the case.

Oct. 1^d. When the magnet was removed, and the weight suspended, afterwards the weight and collimator being lifted off the grooved wheel, the wires turned sharply round towards the east.

The old wire was removed, and great pains taken to obtain one free of twist; six wires were, in succession, rejected; for, though prepared with great care, very different values of v were obtained, according as the magnet was placed with its N. pole easterly or westerly. After much trouble and trials in every way, a wire was got which gave satisfactory results *after* pegging the extremities and winding up (fertile sources of twist). The wires kept nearly the same position with light

and heavy weights, and the value of v with the N. pole of the magnet in opposite directions did not differ 1° —as near a coincidence as seems attainable.

Plane of detorsion coinciding with magnetic meridian, circle reading, $88^\circ 16'$.

Weight attached, arms of circle turned 90° , circle reading, $358^\circ 16'$.

Scale made to read, $150\cdot8^{\text{div}}$.

Magnet inserted, the scale read 150^{div} .

When the torsion circle was made to read, $290^\circ 0'$.

$$r = 68^\circ 16', k = 0\cdot0001303.$$

Oct. 20^d. The general readings of the scale having so increased as to render the middle of the scale (150) no longer the mean position, the arms of the torsion circle were turned $50'$. Circle reading $289^\circ 10'$.

$$v = 69^\circ 6', k = 0\cdot0001248.$$

31. The time of each vibration of the bifilar magnet had been determined by Mr RUSSELL to be about 25 seconds; his observations are not recorded.

The following observations were made.

June 25^d 8^h.

Mean of 7 estimations,		^{s.}	26 ⁰⁰
... 4	...		26 ³²
... 5	...		26 ⁶³
... 4	...		27 ⁰³
... 7	...		26 ⁴⁰

Mean of all, 1 vibration = $26^{\text{s}}\cdot48$.

July 16^d 6^h.

Mean of 8 vibrations,		^{s.}	26 ²⁵
... 6	...		26 ¹⁷
... 8	...		26 ¹⁸

Mean of all, 1 vibration = $26\cdot20$.

The above vibrations were obtained by means of an iron key. Observations when the magnet was vibrating *naturally* gave a result of 25 seconds.

July 18^d 20^h. Observations during a natural vibration :

14 vibrations,	^{s.}	35 ⁵²	1 vibration,	25 ³⁷	
20	...	53 ¹⁰	1	...	26 ⁵⁵

In each of these only two estimations were made, one at the commencement, and one at the termination. The last set is not considered good, as the vibration had nearly ceased when the last estimation was made.

August 22^d 23^h. There being a considerable natural vibration of the bifilar magnet, with little or no change of mean position, the following estimations were made at the extremities of the arcs.

				5 Vibrations.		Mean.
m.	s.	m.	s.	m.	s.	
7	33·0	9	35·0	2	2·0	
7	56·0	10	0·0	2	4·0	
8	22·0	10	25·0	2	3·0	2 ^m 2 ^s ·9
8	47·5	10	49·5	2	2·0	
9	10·5	11	14·0	2	3·5	

Mean, 1 vibration = 24^s·58.

The arc of vibration was 11' during the first 9 vibrations, 9' at the 10th, and at the end of the 11th the magnet stopped.

Oct. 8^d 3^h. The magnet vibrated by a knife.

2 estimations,	mean of 4 vibrations,	1 vibration	25 ^s ·22
2	...	4	...
		1	26 ^s ·28

8 estimations, as below.

		3 Vibrations.		Mean.
s.	s.	s.	s.	
16·2	35·0	78·8		
42·8	0·5	77·7		
8·8	27·0	78·2		78 ^s ·17
35·0	53·0	78·0		

1 vibration = 26^s·06.

Oct. 11^d 23^h. Natural vibration.

2 estimations, mean of 11 vibrations, 1 vibration 25^s·18.

25^s was used throughout in the observations.

32. The point of the scale coinciding with the vertical wire of the fixed telescope is estimated to a tenth of a division, at 25^s before the minute of observation, at the minute, and 25^s after it; the mean is deduced, as in the declination, from the formula $\frac{a+2b+c}{4}$, a , b , and c being the three readings.

The mean thus obtained is corrected to the temperature of 26° Fahr., this being below the lowest temperature which has occurred within the observatory. A constant quantity of 300·0 has been added to all the readings, in order that the mean readings might be about 500; in this case the greatest changes will be contained within 0 and 1000.

The values of 1 scale-division, in parts of the whole horizontal force, are given beneath; they are also given at the foot of each page of the Daily Observations of Magnetometers.

Tables have been formed giving the temperature-correction for every tenth of a degree Fahr. to a tenth of a scale-division, from the formula

$$\frac{(t - 26^\circ)}{k} (q + 2e - e') + 300.0$$

The adopted value of $q = 0.000294$. See § 6.

$$e = .0000103 \quad e' = .0000106.$$

TABLE 11.—Values of k and q for the Bifilar Magnetometer, and the periods to which they apply.

Periods to which the Values apply.	Value of k .	Value of q .
1841.		
July 11 20—July 23 5	0.0001185	Sc. Div. 2.57
Aug. 4 20—Sept. 7 5	0.0001522	2.00
Sept. 7 20—Sept. 30 5	0.0001464	2.08
Oct. 6 20—Oct. 19 20	0.0001303	2.34
Oct. 19 23—Dec. 31 5 and during 1842	0.0001248	2.44

33. As I have had much doubt of the exactness of the values of $\frac{\Delta m}{m}$, I have in all cases given the temperatures along with the corrected observations, so that each magnetician may have it in his power to apply a more accurate correction, if such is to be found.

It is obvious that, supposing the value of $\frac{\Delta m}{m}$ to be well determined, the accuracy of the corrections will depend on the temperature of the magnet being well ascertained.

The error in the observations of the scale will be generally less than 0.1 scale-division; the error in reading the thermometer may be 0.1 Fahr.; the consequent error in correction may, therefore, be upwards of 0.2 scale-division.

The thermometer, by Ross, has a bulb 0.5 inch in diameter; it is inclosed in a glass tube, open at the bulb, which fits into the lid of the magnetometer-box, leaving the stem and scale above, and the bulb below. The box, like that of the Declinometer, was not well closed, and it was soon evident that during a rapid rise or fall of temperature, the thermometer would indicate more or less than the temperature of the magnet.

The fire lighted in the morning, during the winter months, conspired with the temperature of the day to make the increase more rapid than it would otherwise have been; and there is little doubt that the indications of the thermometer would frequently exceed the temperature of the magnet by 1.0 Fahr.

In 1843, having formed inner boxes, and had the whole well closed, Messrs

ADIE and SON were desired to make a thermometer, whose bulb rested in a cup in a brass bar of the same dimensions as the magnet, and covered loosely by a small brass cap.* The following comparisons were made of the indications of the two thermometers, the box being in its original state, and the rise of temperature considerable.

TABLE 12.—Comparisons of the Thermometers with the Bulb free, and with the Bulb in a brass cup.

Göttingen Mean Time.	Thermometer.		Difference.
	Ross.	Adie.	
1844.	°	°	°
Jan. 2 21	30.9	30.7	0.2
22	31.3	31.0	0.3
23	31.9	31.5	0.4
0	33.9	33.0	0.9
1	38.9	37.6	1.3
2	42.3	41.0	1.3
3	44.7	43.0	1.7
4	45.6	44.0	1.6
5	45.9	44.5	1.4
6	46.0	44.9	1.1
7	46.1	45.0	1.1
8	45.9	44.9	1.0
11	45.0	44.3	0.7

34. No observations have been made to determine the effect of the copper ring or damper. It must, however, be small.

During terms, and generally during magnetic disturbances, the temperature is noted at the beginning of each hour; the corrections for observations between the hours are interpolated from those at the beginning of the hours.

ABSOLUTE HORIZONTAL INTENSITY.

35. An observation of absolute horizontal intensity was made by Mr RUSSELL, March 26. 1842. It is given, page 66, with the particulars of reduction.

As there was no extra declinometer, it was necessary to endeavour to eliminate the changes of declination, by reversing the magnet. On account of the imperfections of this method, no other observations were made till 1843, when an extra instrument was obtained.

* It was my original intention to enclose the bulb of the thermometer in a metallic capsule (from which this differs little), but it was difficult to determine the thickness of the capsule. Professor LLOYD, to whom I wrote, informed me that he had already adopted the precaution, having obtained a brass bar of the dimensions of the magnet, containing a small iron cup with mercury, in which the bulb of the thermometer was placed.

§ 5. BALANCE OR VERTICAL FORCE MAGNETOMETER.

36. The Balance Magnetometer is by ROBINSON of London. It is composed of a needle 12 inches long, and about 1 inch broad, with knife-edge axle, resting on agate planes; at the extremities of the needle are brass rings, each carrying a cross of spider's threads. The needle is placed horizontally, at right angles to the magnetic meridian. It is accurately adjusted by means of two fine brass screws; one working horizontally towards one extremity balances the needle, the other near the other extremity, working vertically, regulates its sensibility.

The apparatus is covered by a rectangular box, having glazed openings on two sides, opposite the spider's crosses; those on one side allowing light to be thrown on the crosses from two small mirrors, those on the other for viewing them, and determining their position, which is done accurately by means of microscopes carrying micrometers. There is a thermometer within the box for giving the temperature of the magnet.

37. If m be the moment of free magnetism of the needle, Y the vertical component of the earth's magnetic force, W the weight of the needle, g the distance from the centre of motion to the centre of gravity, ϵ the angle contained by the line joining these two centres, and the magnetic axis of the needle on the horizontal, the magnetic axis being at right angles to the plane of the magnetic meridian; then the equation of equilibrium is

$$m Y = W g \cos \epsilon$$

Whence differentiating the equation and dividing by it

$$\frac{\Delta Y}{Y} = \tan \epsilon \Delta \epsilon - \frac{\Delta m}{m}$$

$\Delta \epsilon$, or the varying angle which the magnetic axis makes with the horizontal, is obtained from observations with the micrometer; for $\frac{\Delta m}{m}$ see section on temperature correction.

It is conceived that ϵ cannot be determined with accuracy by the practical method of inversion, and Dr LLOYD has shewn that it may be obtained from the following formula:

$$\tan \epsilon = \cot \theta \frac{T'^2}{T^2}$$

T' and T being the times of one vibration, the former in the horizontal plane, the latter in the vertical plane, and θ the magnetic dip.

38. Adjustments, &c.

June 16, 17. 1841. Experiments were made to determine the effect of temperature on the balance magnet. See subsequent section.

39. Values, in arc, of the divisions of the micrometer heads. A brass needle

with scales, at the same distance from the centre as the spider's crosses in the magnet, and graduated to 10', was placed on the agate planes of the support, and the moveable wires brought to coincide with the graduated lines of the scale, the micrometer heads being read at each coincidence.

TABLE 13.—Determination of the value of one division of the Micrometer Heads of the Balance Magnetometer, June 21. 1841.

Left Hand Micrometer.					Right Hand Micrometer.				
Scale.	Reading of Micrometer Head.	Scale.	Reading of Micrometer Head.	Micrometer Divisions in 60'.	Scale.	Reading of Micrometer Head.	Scale.	Reading of Micrometer Head.	Micrometer Divisions in 60'.
'	Mic. Div.	'	Mic. Div.	Mic. Div.	'	Mic. Div.	'	Mic. Div.	Mic. Div.
0	16.5	60	614.5	598.0	0	16.0	60	613.8	597.8
10	116.5	70	714.5	598.0	10	116.0	70	713.9	597.9
20	216.3	80	813.9	597.6	20	215.1	80	813.4	598.3
30	316.0	90	913.5	597.5	30	314.8	90	913.1	598.3
40	416.0	100	1013.4	597.4	40	414.4	100	1013.0	598.6
50	515.7	110	1113.0	597.3	50	514.3	110	1112.7	598.4

Mean value of 1 Division, Left Micrometer, 0'.1004
 Right 0'.1003

Another Series, August 30. 1841.

Left Hand Micrometer.					Right Hand Micrometer.				
Scale.	Reading of Micrometer Head.	Scale.	Reading of Micrometer Head.	Micrometer Divisions in 40'.	Scale.	Reading of Micrometer Head.	Scale.	Reading of Micrometer Head.	Micrometer Divisions in 40'.
'	Mic. Div.	'	Mic. Div.	Mic. Div.	'	Mic. Div.	'	Mic. Div.	Mic. Div.
0	19.0	40	417.8	398.8	0	45.0	40	446.7	401.7
10	117.5	50	517.4	399.9	10	145.2	50	547.1	401.9
20	216.2	60	616.9	400.7	20	246.6	60	647.3	400.7
30	319.1	70	716.3	397.2	30	345.0	70	747.8	402.8
0	19.5	40	418.8	399.3	0	44.9	40	446.3	401.4
10	117.4	50	518.2	400.8	10	145.9	50	547.6	401.7
20	217.0	60	616.7	399.7	20	246.0	60	647.4	401.4
30	319.4	70	716.3	396.9	30	345.9	70	747.8	401.9

Mean value of 1 Division, Left Hand Micrometer, 0'.1002
 Right 0'.0996

Observations made Nov. 23. 1843, gave a mean value for both Micrometers 1^d = 0'.1006; this was joined to the above, and the mean of the whole 1^d = 0'.1003 adopted.

June 21. 1841. The balance magnetometer was adjusted with the aid of a horizontal needle and KATER'S compass, so that the magnet of the instrument should be at right angles to the magnetic meridian; the magnet was balanced and its sensibility adjusted by the small screws, and the fixed wires of the microscopes were made to be in the same horizontal plane.

The crosses of gold wire were found loose, and it was necessary to substitute fibres of silk till July 2, when Mr J. ADIE inserted silver wires. It was not found necessary to readjust the magnet, the bisection of the crosses being sufficiently horizontal.

July 6. 1841. A difference of ten micrometer divisions was observed between the readings of the two micrometers, due to the line joining the crosses not passing through the centre of motion.

After July 26. 1841, the north pole of the magnet was towards the east; before that date it was towards the west.

40. Determination of the deviation of the line joining the bisection crosses from the magnetic axis.

For this purpose the needle is reversed on its support; half the difference of the readings in the two positions is the deviation.

TABLE 14.—Observations to determine the deviation of the line joining the Bisection Crosses from the Magnetic Axis of the Balance Needle.

N. end of Needle.	July 27. 1841.			July 27. 1841.			Sept. 1. 1841.			Oct. 2. 1841.			Jan. 11. 1842.		
	Mean of Two Microm.	Mean of Alternate Two.	Diff.	Mean of Two Microm.	Mean of Alternate Two.	Diff.	Mean of Two Microm.	Mean of Alternate Two.	Diff.	Mean of Two Microm.	Mean of Alternate Two.	Diff.	Mean of Two Microm.	Mean of Alternate Two.	Diff.
E.	-195.1			+ 70.5			+265.6			-15.0			-120		
W.	+118.6		306.7	+370.7	+ 60.2	310.5	+190.3	+227.5	37.2	-56.5	-13.7	42.8	-236	- 96	140
E.	-181.1	+100.9	282.0	+ 49.9	+356.8	306.9	+249.3	+173.3	78.0	-12.3	-64.2	51.9	- 72	-239	167
W.	+ 83.1	-235.1	318.4	+343.0	+ 46.8	296.2	+156.2	+221.5	65.3	-71.8	-23.2	48.6	-242	- 84	158
E.	-289.0	+ 27.7	316.7	+ 43.8	+321.0	277.2	+193.7	+147.4	46.3	-34.2			- 96	-227	131
W.	- 27.8			+298.9	+ 25.5	273.4	+138.5	+184.3	45.8				-212	- 89	123
E.				+ 7.3			+175.0	+137.3	37.7				- 83		
W.							+136.0								

<i>July 27. 1841.</i>	1st Series, Mean deviation, 153.0	} Correction for deviation, N. pole east, + 150
... ..	2d Series, 146.4	
<i>Sept. 1. ...</i> 25.7	} - 25
<i>Oct. 2. ...</i> 25.1	
<i>Jan. 11. 1842,</i> 72.0 - 72

The first series of observations, July 27. 1841, giving some reason to conclude that the magnet, on reversal, found different bearing points, the supports of the instrument were examined; the marble base was found quite level, but the south agate

plane higher than the other; the north agate plane was also inclined to the west, and the south agate plane slightly inclined to the east.

In the second series, July 27. 1841, each reading is the mean of two observations, for each of which the needle was lifted. After this observation, the horizontal screw was moved till the readings became about $-150\cdot0$; the north pole of the magnet being turned east.

The correction for deviation of the line joining the crosses from the magnetic axis has not been applied.

Aug. 30. 1841. Mr SIMMS, of London, adjusted the agate planes of the balance magnetometer. They do not, however, seem to be perfect planes, but have a slight degree of convexity in the centre. Mr SIMMS also inserted spider's threads for the bisection crosses, instead of the silver wire; the reading micrometers were adjusted at the same time.

41. Vibration of the balance magnet in a horizontal plane.

The magnet was attached to the suspension thread of the declinometer by means of a light stirrup of card in the first four observations, and of the same silk as the suspension thread on the other occasions. A small piece of wire in the first four observations, and of paper afterwards, was gummed to the extremity of the needle, and the times of passing the wire of the fixed telescope were noted. The corrected time T' is deduced from the observed time of vibration t , by the formula

$$T' = t \left(1 + \frac{H}{2F} - \frac{\alpha \alpha'}{16} \right)$$

The value of $\frac{H}{2F}$ for the balance magnet is deduced from that of $\frac{H}{F}$ for the declination magnet, in multiplying the latter by the coefficient.

$$\frac{\text{Force of Declination Magnet}}{2 \text{ Force of Balance Magnet.}}$$

TABLE 15.—Values of T' , the Time of Vibration of the Balance Needle in a Horizontal Plane.

Date.	Number of Estimations.	Number of Vibrations.	Semi-Arc.		Time of one Vibration.		
			Commencing.	Ending.	Observed.	Corrected for Torsion.	Corrected for Torsion and Arc.
July 6. 1841	28	28	o	o	s.	s.	s.
Aug. 3. 1841	16	144			11.920	11.950 ?	11.950 ?
Sept. 4. 1841	12	128			11.980	12.010	12.000 ?
Jan. 11. 1842	6	150			11.930	11.962	11.952 ?
Jan. 11. 1842	6	150			11.969	11.998	11.986 ?
Aug. 24. 1843	28	120	8 0	2 0	11.965	12.012	12.008
Sept. 4. 1843	40	190	2 30	3 0	11.978	12.026	12.017
Jan. 27. 1844	16	70	9 30	3 30	11.959	12.007	11.999

42. Vibration of the balance magnet in the vertical plane.

The needle being in its usual position on the supports, the moveable wire of the left micrometer is made to bisect the spider cross; the needle is then vibrated, by means of a small piece of iron, through an angle, varying from 10' to 5', and the periods of the cross passing the wire estimated.

TABLE 16.—Values of T, the Time of Vibration of the Balance Needle in a Vertical Plane.

Date.	Number of Vibrations.	Time of one Vibration.		Adopted Mean.	Remarks.	
		Observed.	Adopted.			
d. h.		s.	s.	s.		
1841.						
July 6 0	10	10.72	10.60	10.6	Adjustment, &c., after July 23 ^d .	
Aug. 3 4	48	10.25	10.04	10.0		
Aug. 3 4	54	10.17			10.63	10.6
Sept. 4 5	36	10.83				
Sept. 4 5	84	10.69				
Sept. 4 5	96	10.61				
Sept. 27 5	44	10.69	10.65			
Sept. 27 5	66	10.66				
Oct. 2 4	42	11.07	11.06	11.0	{ Oct. 2 ^d 2 ^h . Needle reversed to determine the deviation of the crosses.	
Oct. 2 4	54	11.09				
Oct. 16 4	56	11.08	11.05			
Oct. 16 4	34	11.03				
Oct. 29 4	50	11.03	11.00			
Nov. 20 3	80	10.99	10.97			
Dec. 3 4	18	11.00	10.98			
Dec. 3 4	60	11.01				
1842.						
Jan. 15 5	38	10.70	10.66	10.6		{ Jan. 1 ^d , &c. Needle removed in order to determine its temperature correction.
Jan. 29 5	46	10.32	10.30	10.1		
Feb. 12 5	30	10.15	10.04			
Feb. 12 5	57	10.19		10.32		
Mar. 5 6	63	10.34	10.02			
Mar. 19 5	48	10.15				
Mar. 19 5½	42	10.12	11.0	{ March 22 ^d . Needle vibrated excessively by iron brought near it by visitors.		
Apr. 2 6	68	11.02			10.96	
Apr. 9 5	56	10.94			10.91	
Apr. 16 0	60	11.02			10.96	
Apr. 23 0	36	10.77			10.64	
Apr. 23 0	36	10.72				
Apr. 23 0	30	10.82				
June 20 6	50	10.65	10.60			
June 20 6	40	10.65				
June 25 8	30	10.58	10.56			
June 25 8	50	10.59				
July 16 6	50	10.46	10.42	10.5		

TABLE 16—*continued.*

Date.	Number of Vibrations.	Time of one Vibration.		Adopted Mean.	Remarks.
		Observed.	Adopted.		
d. h.		s.	s.	s.	
1842.					
Aug. 2 8	30	10.42	10.40		
Aug. 13 8	40	10.44	10.42		
Sept. 7 23	20	10.52	10.45		
Sept. 7 23	10	10.47			
Sept. 7 23	20	10.54			
Sept. 24 5	40	10.55	10.44		
Oct. 8 2	30	10.39	10.30		
Oct. 8 2	20	10.29			
Oct. 8 2	20	10.36			
Oct. 31 2	10	10.07	10.05		
Oct. 31 2	30	10.19			
Oct. 31 2	20	10.04			
Oct. 31 2	10	9.96			
Nov. 10 20	20	10.31	10.33		{ Nov. 10 ^d 6 ^h . Needle vibrated accidentally by steel compasses.
Nov. 10 20	20	10.35			
Nov. 18 23	20	10.04	10.00		
Nov. 18 23	10	9.96			
Dec. 8 3	20	10.04	9.98	10.0	
Dec. 8 3	20	10.04			
Dec. 20 2	20	10.05	10.02		
Dec. 20 2	10	10.03			
Dec. 20 2	10	9.98			
Dec. 31 2	10	9.75	9.77		
Dec. 31 2	10	9.84			
Dec. 31 2	20	9.84			

The adopted time of vibration has been obtained from the last observations in each series, and differs slightly from the observed time of the whole series.

TABLE 17.—Effect of the Bifilar and Declination Magnets on the Balance Magnet.

North End of Magnet.		First Series.			Second Series.		
Declination.	Bifilar.	Balance Reading.	Effect of Magnet.		Balance Reading.	Effect of Magnet.	
			Declination.	Bifilar.		Declination.	Bifilar.
		Mic. Div.	Mic. Div.	Mic. Div.	Mic. Div.	Mic. Div.	Mic. Div.
N.	W.	- 188.0	0.2		+ 231.8	0.1	
S.	W.	- 188.3					
N.	W.	- 187.7					
N.	E.	- 183.5					
N.	W.	- 186.1					
				3.4	+ 234.2		1.7
					+ 233.0		

The position of the Balance Needle was altered for the second series of observations.

43. Observations and reductions.

The moveable wires of the two micrometers are made to bisect the crosses of the magnet, the interval between the bisections being the time of the needle's vibration in the vertical plane, 10^s was used; the first coincidence was therefore 5^s before, and the second 5^s after, the minute of observation.

The mean of the two readings is taken for the position of the needle.

The reading is nearly zero when the needle is horizontal. The readings increase negatively or positively as the north pole of the needle moves above or below the horizontal; it is generally above it, and in this case the readings have been subtracted from a constant *plus* the temperature correction, in order that they may always be positive, and increase with increasing force.

44. The variations of the vertical force depend chiefly for their accurate determination on the accuracy of the value of T. There are sources of error, however, in the determination of the latter, which are not taken account of in theory.

From several series of observations made in 1843 and 1844, I have found that the time of vibration in the vertical plane depends on the arc of vibration to a much greater extent than theory would allow; that it is considerably increased if the needle have been *previously* vibrated through a large arc, and the effect of this large vibration remains for a considerable period (at least some weeks), but above all it depends on temperature. The effect of a rise of 1° Fah., is equivalent to an increase in the time of vibration of about $0^s.07$.

The full discussion of these observations must be reserved for another place. It was necessary to mention them here, however, as they affect the reductions in this volume.*

45. The observations are given in micrometer division, it was necessary, therefore, to reduce the value of $\frac{\Delta m}{m}$ to micrometer divisions, for the purpose of correction. The values of T have been placed in groups, and a mean value taken for the period to which the group belongs.

If n be the number of micrometer divisions, α the arc value of one in parts of radius, the equation of equilibrium becomes

$$\frac{\Delta Y}{Y} = n \alpha \cot \theta \frac{T'^2}{T^2} - \frac{\Delta m}{m}$$

$$\frac{\Delta Y}{Y} \frac{T^2}{\alpha \cot \theta T'^2} = n - \frac{\Delta m}{m} \frac{T^2}{\alpha \cot \theta T'^2}$$

The values of $k = \alpha \frac{\cot \theta T'^2}{T^2}$, of $q = -\frac{\Delta m}{m t}$, t being the number of degrees from the assumed zero, and the corresponding value of $\frac{q}{k}$ or the values of q , in micrometer

* See a paper, entitled "The Balance Magnetometer and its Temperature Correction," in the Transactions of the Royal Society of Edinburgh, Volume xvi., Part i.

divisions, are given, with the periods to which they apply, in the following table, and at the foot of each page of the Daily Observations.

The adopted value of

$$\theta = 71^{\circ} 12'.$$

See section 7.

TABLE 18.—Values of k and q for the Balance Magnetometer, and the periods to which they apply.

Periods to which the Quantities apply.				Value of k .	Value of q .
1841.					Mic. Div.
July	11 20—	July	23 5	0.0000127	5.74
Aug.	4 20—	Aug.	28 5	0.0000143	5.10
Sept.	5 20—	Sept.	30 5	0.0000127	5.74
Oct.	6 20—	Nov.	30 5	0.0000118	6.20
1842.					
Jan.	12 20—	Jan.	22 5	0.0000127	5.74
Jan.	23 20—	March	21 5	0.0000140	5.20
March	21 20—	April	16 5	0.0000118	6.20
April	17 20—	Oct.	8 5	0.0000130	5.60
Oct.	9 20—	Dec.	31 5	0.0000143	5.10

§ 6. OBSERVATIONS FOR THE TEMPERATURE CORRECTIONS OF THE BIFILAR AND BALANCE MAGNETS.

46. *June 16. 1841.*—Experiments were made to determine the effect of temperature on the bifilar and balance magnets. For this purpose, the magnet was placed in a copper trough, and surrounded with ice, or water of the desired temperature. The trough was placed on a stand upwards of 5 feet east of the declination instrument, so that the axis of the magnet should be at right angles to that of the declinometer. A thermometer was placed in the trough beside the magnet. Seven readings of the declinometer were made in each of the following positions, N. pole E., N. pole W., N. pole E., in order to eliminate the changes of declination. The observations are not worth recording, owing to the imperfections of the method; the following is the final result for the bifilar magnetometer, $q = 0.000353$.

January 1, 2, &c., 1842. Experiments were made on the balance magnet. The same method was adopted as on June 16, excepting that the balance needle was placed nearer the suspended magnet (within 4 feet); that the needle was repeatedly reversed, and the bifilar magnetometer observed during the experiments.

The discordances of partial results were so great, that only the final result is given here,

$$q = 0.0001283.$$

It was evident that no good result could be obtained without an extra declinometer, owing to the necessity of reversing the needle, in order to eliminate the changes of declination, when the slightest alteration of position would have far more effect than the greatest change of temperature.

47. Having had a small wooden house erected at some distance from the Observatory, and having formed an extra or unifilar magnetometer, observations were made to determine the temperature corrections, according to the method recommended in the "Revised Instructions," by the Committee of the Royal Society.

The magnets were placed in a copper trough, as in the previous observations, and the temperature varied by means of ice and water of different temperatures. The declination magnet was observed at the same seconds as the deflected magnet, and the bifilar immediately before and after each temperature.

Owing to the small deflection, the observations on the first day were valueless, and are not given here. The centre of the balance magnet was placed afterwards at a distance of about 3 feet from the suspended magnet.

48. The following tables contain the observations.

The results in the last column are obtained from the formula

$$\left. \begin{array}{l} -Q \\ -q \end{array} \right\} = \frac{u - u_0 - r \overline{d - d_0}}{D(t - t_0)} + \frac{k(b - b_0)}{t - t_0}$$

where u and u_0 are the unifilar readings, d and d_0 the declinometer readings, b and b_0 the bifilar magnetometer readings at the temperatures t and t_0 of the deflecting magnet; D the mean deflection; r the coefficient for reducing the declinometer scale divisions to those of the unifilar; and k the value of the bifilar magnetometer scale divisions, in parts of the whole horizontal force.

During the observations for the temperature correction of the bifilar magnet, another magnet was substituted for the bifilar magnetometer; for it

$$k = 0.0002263 ;$$

during the observations for the balance magnet, the following were the values of K

$$\left. \begin{array}{l} \text{Aug. 23}^d \text{ 1843,} \\ \text{Sept. 1 1843,} \\ \text{Sept. 2 1843,} \end{array} \right\} k = 0.0001204 \quad \left. \begin{array}{l} \text{Nov. 13 1843,} \\ \text{Jan. 27 1844,} \end{array} \right\} k = 0.0001300.$$

Owing probably to currents of air, the difference of the declinometer and unifilar scale readings at the beginning and end of the series Aug. 23, 24, and 31, Table 20, had varied considerably. The change was supposed uniform; and the declinometer readings adopted are those interpolated for the change.

TABLE 19.—Observations to determine the Temperature Correction of the Bifilar Magnet.

Göttingen Mean Time.		Temperature of Bifilar Magnet.	$t-t_0$.	Reading of Unifilar.	Reading of Declinometer reduced = $r d$.	$u-u_0$ minus $r(d-d_0)$.	Bifilar.		- Q.
							Reading Corrected.	Thermometer.	
d.	h. m.	°	°	Sc. Div.	Sc. Div.	Sc. Div.	Sc. Div.	°	
Nov. 9	0 13	Magnet	Away.	260.69	153.86				
	0 55	34.97		7.72	154.20		149.21	36.7	-0.000326
	1 14	57.60	22.63	10.11	154.69	-1.90	150.07	36.8	-0.000296
	1 30	78.05	20.45	10.85	153.86	-1.57	150.99	36.9	-0.000274
	1 48	60.72	17.33	10.06	154.25	-1.18	151.18	37.0	-0.000258
	2 6	35.10	25.62	9.33	155.17	-1.65	151.28	37.2	-0.000258
	2 24	57.80	22.70	12.05	156.28	-1.61	151.30	37.5	-0.000283
	2 45	81.10	23.30	14.63	156.73	-2.13	152.71	37.8	-0.000352
	3 1	59.50	21.60	12.88	156.56	-1.58	154.43	37.9	-0.000311
	3 18	35.97	23.53	11.96	157.05	-1.41	155.13	38.1	-0.000246
	3 36	57.55	21.58	13.55	157.09	-1.55	155.64	38.4	-0.000282
	3 52	81.35	23.80	15.77	157.58	-1.73	154.66	38.6	-0.000342
	4 8	59.05	22.30	13.84	157.03	-1.38	155.78	38.7	-0.000258
	4 24	35.25	23.80	12.54	157.78	-2.05	155.77	38.8	-0.000344
	4 41	69.65	34.40	15.40	157.92	-2.72	155.67	38.8	-0.000315
	5 4	34.65	35.00	13.14	158.49	-2.83	155.31	38.9	-0.000319
	5 20	Magnet	Away.	266.39	158.76				
Nov. 9	23 17	Magnet	Away.	265.41	157.84				
	9 23 49	33.65		9.17	156.90		149.65	38.1	-0.000245
10	0 8	59.12	25.47	10.55	156.67	-1.61	150.18	38.2	-0.000285
	0 29	80.60	21.48	11.78	156.33	-1.57	150.60	38.5	-0.000293
	0 45	61.85	18.75	10.39	156.31	-1.37	150.92	38.6	-0.000271
	1 5	35.30	26.55	7.97	155.66	-1.77	151.86	38.7	-0.000275
	1 22	58.90	23.60	9.87	155.87	-1.69	152.62	38.8	-0.000275
	1 37	77.50	18.60	11.36	155.88	-1.48	152.82	38.8	-0.000312
	1 55	56.60	20.90	9.93	156.06	-1.61	153.13	38.9	-0.000308
	2 11	34.50	22.10	8.12	155.90	-1.65	153.11	38.9	-0.000295
	2 28	61.35	26.85	10.38	156.20	-1.96	153.52	39.0	-0.000285
	2 46	83.50	21.15	12.43	156.59	-1.66	153.78	39.0	-0.000306
	3 3	57.90	25.60	10.84	156.79	-1.79	152.51	39.1	-0.000265
	3 20	35.75	21.15	9.02	156.83	-1.86	150.84	39.2	-0.000329
	3 38	58.65	22.90	10.14	156.47	-1.48	152.76	39.4	-0.000236
	3 57	78.75	20.10	13.35	157.72	-1.96	152.75	39.6	-0.000385
	4 18	36.25	42.50	10.20	157.76	-3.19	151.65	39.7	-0.000291
	4 43	68.30	32.05	12.85	157.91	-2.50	153.49	39.8	-0.000294
	4 55	Magnet	Away.	264.91	157.65				

49. The mean of the partial results, November 9, is $Q=0.0002979$.

..... 10, is $Q=0.0002915$.

The mean of all the partial results is $Q=0.0002945$.

Correction for the expansion of the silver wires and brass grooved wheel is 0.000010 (No. 32.), whence the adopted value,

$$q=0.000304.$$

TABLE 20.—Observations to determine the Temperature Correction for the Balance Magnet.

Göttingen Mean Time.			Temperature of Balance Magnet.	$t-t_0$.	Reading of Unifilar.	Reading of Declinometer reduced $=r d$.	Adopted reading of Declinometer.	$u-v_0$ minus $r(d-d_0)$.	Bifilar.		$-q$.
d.	h.	m.	°	°	Sc. Div.	Sc. Div.	Sc. Div.	Sc. Div.	Sc. Div.	°	
Aug. 23	20	31	Magnet	Away.	270.35	161.48					
	21	54	59.45		476.03	159.51	158.36	+0.42	125.30	53.3	+0.0000524
	22	44	46.70	12.75	469.02	153.61	151.77	-0.39	136.34	54.0	-0.0000956
	23	11	66.00	19.30	467.06	152.44	150.20	-0.22	134.62	54.8	-0.0000311
	23	38	90.00	24.00	465.47	151.41	148.83	-0.52	135.56	55.7	-0.0001780
Aug. 24	0	17	70.00	20.00	462.53	148.49	145.37		142.98	57.1	
	0	46	Magnet	Away.	250.98	145.63					
	1	28	66.95		459.13	145.54	145.86	-0.48	136.57	60.1	-0.0001130
	2	1	38.50	28.45	463.32	149.00	149.57	-0.20	143.82	61.2	-0.0000259
	2	29	63.45	24.95	464.33	150.00	150.78		143.58	62.3	
	2	42	Magnet	Away.	255.99	149.76					
	3	0	66.15		464.19	149.91	150.18	-0.64	145.28	63.8	-0.0000872
	3	29	87.00	20.85	464.08	150.01	150.71	-0.54	155.87	64.4	-0.0000694
	3	57	62.90	24.10	466.53	151.51	152.62	-0.87	146.51	65.1	-0.0001743
	4	28	37.30	25.60	474.77	158.42	159.99	-0.84	147.32	65.8	-0.0001225
	4	56	69.15	31.85	470.58	154.66	156.64		147.37	66.5	
	5	10	Magnet	Away.	262.89	154.47					
Aug. 31	22	25	Magnet	Away.	260.23	153.71					
	23	10	60.95		461.86	150.92	150.62	-0.19	123.47	62.9	
	23	34	42.10	18.85	458.34	147.39	146.91		124.88	63.1	-0.0000582
Sept. 1	0	0	Magnet	Away.	250.82	144.87					
	0	21	64.15		453.52	142.97		-0.36	120.09	63.9	-0.0000669
	0	38	85.20	21.05	453.42	143.23		-0.11	122.90	64.0	-0.0000650
	0	59	66.25	18.95	453.45	143.15		-0.28	128.72	64.4	-0.0000895
	1	20	43.20	23.05	453.06	142.48		-0.59	134.44	64.9	-0.0000871
	1	43	64.85	21.65	451.08	141.09		-0.56	142.78	65.0	-0.0001184
	2	3	90.55	25.70	450.34	140.91		-0.70	140.30	65.2	-0.0000813
	2	24	65.40	25.15	452.06	141.93		-0.96	128.80	65.4	-0.0001586
	2	46	80.70	15.30	449.00	139.83		-0.36	147.70	65.6	-0.0000491
	3	10	60.00	20.70	447.49	137.96		-1.37	141.49	65.7	-0.0002329
	3	35	40.85	19.15	455.50	144.60		-1.22	122.78	65.9	-0.0000885
	3	58	64.70	23.85	453.93	146.25		-0.35	154.87	66.0	-0.0001071
	4	18	86.60	21.90	456.90	147.57		-0.43	149.65	66.2	-0.0000533
	4	41	66.20	20.40	453.95	144.19		+0.35	141.19	66.5	-0.0000326
	5	6	41.35	24.85	453.60	144.19		+0.95	162.14	66.7	+0.0000893
	5	29	65.55	24.20	460.84	150.48		+0.16	141.45	66.9	+0.0000288
	5	49	85.50	19.95	467.10	156.58		-0.87	139.71	67.0	-0.0001348
	6	10	62.00	23.50	472.23	160.84			130.62	67.0	
	6	46	Magnet	Away.	260.07	153.59					
Sept. 1	23	8	Magnet	Away.	251.32	145.99					
	23	48	65.90		466.17	147.68		-0.21	106.84	66.3	-0.0000162
Sept. 2	0	6	89.60	23.70	467.63	149.35		-0.36	111.89	66.7	-0.0000726
	0	22	66.95	22.65	466.76	148.12		-0.24	111.42	67.1	-0.0000732
	0	39	39.40	27.55	465.97	147.09		-0.22	118.74	67.4	-0.0000598
	0	57	63.60	24.20	463.93	145.27		-0.62	115.37	67.7	-0.0000958
	1	18	87.45	23.85	463.45	145.41		-0.16	120.71	68.0	-0.0000720
	1	37	66.25	21.20	462.73	144.53		-0.99	127.09	68.3	-0.0001282
	1	57	41.60	24.65	465.04	145.85		-0.87	114.50	68.6	-0.0001035
	2	13	65.00	23.40	463.26	144.94		-0.22	128.50	68.7	-0.0000757
	2	30	83.15	18.15	462.30	144.20		-0.23	125.73	68.9	-0.0000816
	2	50	63.45	19.70	462.77	144.44		-0.77	130.04	69.0	-0.0001185
	3	10	40.35	23.10	465.88	146.78		-0.28	122.56	69.0	-0.0000733
				24.65							

TABLE 20.—*continued.*

Göttingen Mean Time.			Temperature of Balance Magnet.	$t-t_0$	Reading of Unifilar.	Reading of Declino- meter reduced $=r d$.	$u-u_0$ minus $r(d-d_0)$.	Biflar		$-z$.
								Reading corrected.	Thermo- meter.	
d.	h.	m.	°	°	Sc. Div.	Sc. Div.	Sc. Div.	Sc. Div.	°	
Sept. 2	3	28	65.00	22.75	465.90	147.08	-0.48	118.54	69.0	-0.0000891
	3	45	87.75	21.45	466.23	147.89	-0.27	120.54	69.0	-0.0000867
	4	3	66.30	26.15	467.04	148.43	-0.09	125.39	69.2	-0.0000849
	4	22	40.15	25.00	467.95	149.25	-0.26	140.27	69.4	-0.0000626
	4	44	65.15	23.00	468.45	150.01	-0.34	137.49	69.5	-0.0000706
	5	1	88.15	22.70	469.22	151.12	-1.11	137.34	69.6	-0.0001581
	5	19	65.45	26.90	473.31	154.10	+0.14	123.61	69.7	-0.0000276
	5	37	38.55	33.45	473.44	154.37	-0.20	135.25	69.7	-0.0000332
	5	57	72.00		476.52	157.65		133.87	69.7	
		6	13	Magnet	Away.	272.00	162.31			
Nov. 12	22	55	Magnet	Away.	266.58	159.61				
	23	22	33.70	25.50	11.37	158.02	-0.32	181.77	41.1	-0.0000514
Nov. 13	23	35	59.20	20.90	10.72	157.05	-0.05	181.38	41.2	-0.0000071
	23	45	80.10	22.30	10.74	157.02	-0.73	182.78	41.3	-0.0001398
Nov. 13	23	57	57.80	22.80	8.56	155.57	-0.51	184.66	41.5	-0.0000836
	0	8	35.00	19.90	7.50	155.02	-0.34	183.87	41.6	-0.0000619
Nov. 13	0	19	54.90	24.05	8.73	155.91	-0.30	184.69	41.7	-0.0000442
	0	30	78.95	20.70	8.99	155.87	-0.46	185.60	41.8	-0.0000814
Nov. 13	0	41	58.25	22.95	8.19	155.53	-0.43	184.63	41.9	-0.0000784
	0	53	35.30	23.75	7.51	155.28	-0.38	185.45	42.0	-0.0000443
Nov. 13	1	7	59.05	15.30	6.84	154.23	-0.28	188.86	42.2	-0.0000560
	1	20	74.35	18.35	7.23	154.34	-0.18	190.75	42.5	-0.0000128
Nov. 13	1	32	56.00	21.70	7.43	154.72	-0.65	187.12	42.7	-0.0001538
	1	44	34.30	26.40	3.66	151.60	-0.45	193.11	42.9	-0.0000888
Nov. 13	1	56	60.70	21.05	5.87	153.36	-0.51	188.72	43.0	-0.0000988
	2	7	81.75	22.40	7.58	154.56	-0.16	188.16	43.3	-0.0000299
Nov. 13	2	18	59.35	24.50	8.14	155.28	-0.11	188.46	43.6	-0.0000251
	2	29	34.85	24.65	8.33	155.58	-0.66	189.86	43.9	-0.0000882
Nov. 13	2	40	59.50	21.50	8.82	155.41	-0.61	193.12	44.1	-0.0000854
	2	50	81.00	23.00	8.27	154.25	-0.55	197.47	44.3	-0.0000903
Nov. 13	3	2	58.00	24.45	7.39	153.92	-0.21	196.79	44.7	-0.0000150
	3	14	33.55	21.45	7.68	154.42	-0.44	193.26	44.9	-0.0000511
Nov. 13	3	26	55.00	29.25	4.59	151.77	-0.30	188.37	45.0	-0.0000618
	3	37	84.25	23.10	2.84	149.72	-0.99	183.56	45.1	-0.0001453
Nov. 13	3	48	61.15	27.25	0.27	148.14	-0.05	179.40	45.5	-0.0000117
	3	59	33.90	23.05	2.58	150.40	-0.25	178.46	45.7	-0.0000411
Nov. 13	4	9	56.95	26.40	3.80	151.37	-0.48	178.75	45.8	-0.0000832
	4	21	83.35	46.90	5.73	152.82	-0.60	176.38	45.9	-0.0000653
Nov. 13	4	38	36.45	36.85	5.71	153.40	-0.59	181.76	46.0	-0.0000840
	4	53	73.30	38.40	8.42	155.52	-0.19	175.82	46.0	-0.0000448
Nov. 13	5	18	34.90		10.54	157.83		183.30	46.0	
	5	30	Magnet	Away.	267.75	160.90				
1844.										
Jan. 27	0	16	Magnet	Away.	260.87	157.22				
	1	9	35.47	30.58	12.08	154.78	-0.62	189.43	45.0	-0.0000836
	1	22	66.05	28.00	12.93	155.01	-0.37	189.11	45.0	-0.0000536
	1	36	38.05	26.32	13.59	156.04	-0.39	189.10	45.0	-0.0000579
	1	49	64.37	27.37	14.67	156.73	-0.44	189.54	45.0	-0.0000699
	2	1	37.00	28.05	14.21	156.71	-0.79	190.53	45.0	-0.0001106
	2	17	65.05	26.88	15.30	157.01	-0.63	191.25	45.1	-0.0000911
	2	32	38.17	27.63	15.52	157.86	-0.40	190.43	45.1	-0.0000589
	2	48	65.80	26.85	16.76	158.70	-0.37	190.39	45.2	-0.0000557

TABLE 20—continued.

Göttingen Mean Time.			Tempe- rature of Balance Magnet.	$t-t_0$.	Reading of Unifilar.	Reading of Declino- meter reduced = $r d$.	$u-u_0$ minus $r(d-d_0)$.	Bifilar.		$-q$.
								Reading corrected.	Thermo- meter.	
d.	h.	m.	°	°	Sc. Div.	Sc. Div.	Sc. Div.	Sc. Div.	°	
Jan.	27	3 2	38.95	24.75	16.96	159.27	-0.46	190.35	45.3	-0.0000766
		3 21	63.70	27.35	18.05	159.90	-0.31	190.12	45.5	-0.0000480
		3 40	36.35	32.20	17.96	160.12	-0.43	190.47	45.6	-0.0000625
		3 58	68.55	30.30	19.14	160.87	-0.57	188.42	45.6	-0.0000681
		4 13	38.25	24.30	18.66	160.96	-0.54	186.50	45.7	-0.0000851
		4 31	62.55	26.70	18.89	160.65	-0.53	187.44	45.8	-0.0000853
		4 49	35.85	29.40	18.60	160.89	-0.64	188.42	45.9	-0.0000954
		5 4	65.25	29.35	19.46	161.11	-0.40	186.82	45.9	-0.0000650
		5 20	35.90	19.11	19.11	161.16		189.01	45.9	
		5 31	Magnet	Away.	265.82	160.84				

50. The means of the partial results on the different days were given weights depending on the formula,

$$\text{Weight} = \frac{\text{Number of partial results}}{\text{Mean of the squares of the partial results minus the square of the mean}}$$

Aug. 23 ^d —24 ^d	1843.	Mean of the partial results $q = 0.0000845$	Weight = 49
Aug. 31 ^d —Sept. 1 ^d	...	$q = 0.0000768$ = 79
Sept. 1 ^d — 2 ^d	...	$q = 0.0000792$ = 425
Nov. 12 ^d —13 ^d	...	$q = 0.0000620$ = 320
Jan. 27 ^d	1844.	$q = 0.0000729$ = 1157

Whence the resulting value,

$$q = 0.000073.$$

51. Having much doubt as to the accuracy and sufficiency of this method of determining the temperature correction, and feeling its insufficiency especially in the case of the balance magnet, where the time of vibration in a vertical plane is employed, in whatever form the corrected observations be given, I attempted to deduce the temperature corrections from the usual daily observations in 1843 and 1844.

For the methods adopted in deducing these results, I must refer to the paper cited, No. 44.

It is enough to mention here the final results :

For the bifilar magnet $q = 0.000247$ in parts of the whole horizontal force. This value has been used in correcting the Abstracts of Results at the end of this volume.

For the balance magnet $q = 7.90$ micrometer divisions.

As the observations for 1843 gave the same result for the balance magnet as those for 1844, independently of changes of adjustment and times of vibrations, the value of $q = 7.90$ Mic. div. has been applied in the abstracts of the observations.

§ 7. INCLINOMETER.

52. The Dip Instrument is by ROBINSON of London. The vertical circle, $9\frac{1}{2}$ inches in diameter, is divided to $10'$; and $1'$ is estimated with the aid of lenses attached to the instrument. The horizontal circle, 6 inches in diameter, with a vernier, reads to $1'$. There are two needles, marked No. 1 and No. 2, and one end of each needle is marked A, the other end, B.

Till 1843, the instrument occupied the pillar I, in the plan, next to the declinometer, and it was necessary to remove the declination magnet during observations of dip.

The reading of the horizontal circle, for the vertical circle in the magnetic meridian, was obtained with the aid of a horizontal needle carried on a pivot, whose arms rest on the Ys of the instrument.

53. The dipping needle is observed in four positions, with one end dipping, namely, the circle being in the meridian, with its graduated face east and west, the marked side of the needle being with the graduated face and from it; as each extremity of the needle is observed, there are thus eight readings obtained. The poles being changed, and the other end dipping, other eight readings are similarly obtained. The mean of the sixteen readings is taken for the dip. In this volume, the mean of each eight readings is given.

In changing the poles, the needle was placed on a small wooden block having a hole to receive the axle, and received eight strokes on each face from two small magnets.

The needle, No. 1, was generally used. The level of the agate planes was occasionally verified by means of a small level. This had to be done always with the door shut, as it is in observations; the level varied with the door open.

54. Observations were made in different azimuths on April 18. and May 2. 1843, in order to determine the correction due to the vertical copper circle and to the axle of the needle.

η and η' being the inclinations observed in two planes, at right angles to each other, the true dip θ is deduced by the formula

$$\cot^2 \theta = \cot^2 \eta + \cot^2 \eta'$$

The following tables contain the observations and results.

In reading these observations, the circle was considered to be graduated from 0° to 180° , commencing with the right side of the horizontal diameter, counting down, and from the left side of the same diameter, counting up.

TABLE 21.—Observations for Magnetic Dip in different Azimuths.

Azimuth.	B Dipping.				A. Dipping.				Mean.
	Limb E.		Limb W.		Limb E.		Limb W.		
	Face of Needle		Face of Needle		Face of Needle		Face of Needle		
	E.	W.	E.	W.	E.	W.	E.	W.	
0	73 7.0	69 39.5	107 20.5	110 48.0	70 10.0	73 31.5	110 29.0	106 56.0	71 21.81
30	75 3.0	71 38.5	104 54.5	109 1.0	72 12.0	76 2.0	108 31.0	104 23.5	73 30.69
120	101 44.5	98 3.0	78 31.5	82 10.0	97 32.0	101 40.5	82 49.0	78 54.5	80 25.62
60	82 22.0	78 19.0	97 54.0	101 51.0	78 54.5	82 55.0	101 40.0	97 24.0	80 27.69
150	109 20.0	104 54.5	71 19.0	74 54.0	104 34.0	108 26.0	75 48.0	72 19.0	73 23.19
0	73 35.5	69 19.0	107 8.0	111 19.5	70 1.0	73 38.0	110 31.0	106 46.0	71 21.12
15	73 55.0	69 43.0	106 31.0	111 0.0	70 31.5	74 10.0	110 9.0	106 22.0	71 47.19
30	75 38.0	70 39.0	104 26.0	110 4.0	72 5.0	75 58.0	108 48.0	104 33.5	73 18.56
45	79 9.0	73 40.0	101 17.0	106 38.0	74 56.0	78 57.0	105 39.0	101 31.0	76 27.12
60	83 12.0	77 39.0	97 7.0	102 54.0	78 44.0	83 0.0	101 54.0	97 18.0	80 25.25
75	87 56.0	82 19.5	92 30.0	98 16.0	83 12.5	87 21.5	97 23.0	93 5.5	84 56.87
90	93 8.5	87 15.5	87 22.0	93 10.5	87 58.0	92 19.0	92 30.0	88 4.5	89 46.50
105	98 14.0	92 26.0	82 24.0	87 58.0	92 59.0	97 17.0	87 27.5	83 12.5	85 0.75
120	102 49.0	97 12.0	77 46.0	83 11.0	97 6.0	101 51.0	83 2.0	78 42.5	80 27.94
135	106 42.0	101 21.0	72 51.0	79 9.0	101 26.0	105 40.0	78 57.0	74 53.0	76 20.12
150	110 2.5	104 30.0	70 50.0	75 42.5	104 26.5	108 49.5	76 1.0	72 1.0	73 20.75
165	111 3.0	106 34.0	69 44.0	74 0.0	106 19.0	110 0.0	74 10.5	70 24.5	71 47.87

TABLE 22.—Magnetic Dip deduced from the Observations in Table 23.

Azimuths.	η .	η' .	θ .
30 and 120	73 30.69	80 25.62	71 11.0
60 ... 150	80 27.69	73 23.19	71 5.9
0			71 21.8
0 and 90	71 21.12	89 46.50	71 20.9
15 ... 105	71 47.19	85 0.75	71 11.9
30 ... 120	73 18.56	80 27.94	71 2.1
45 ... 135	76 27.12	76 20.12	71 6.5
60 ... 150	80 25.25	73 20.75	71 2.6
75 ... 165	84 56.87	71 47.87	21 11.9

In the first series, giving the observation at Azimuth 0° a value

$$\theta = 71^\circ 12'.9; \text{ Correction for Needle No. 1} = - 8'.9$$

in the second series,

$$\theta = 71^\circ 9'.3; \text{ Correction for Needle No. 1} = - 11'.8$$

In the Abstracts of Magnetic Dip the observations have been corrected by $- 12'$.

METEOROLOGICAL INSTRUMENTS.

§ 8. BAROMETER.

55. A Mountain Barometer, by ADIE & SON, was used from July 1841 till January 1842. The scale is engraved on the brass tube, and reads, with a vernier, to 0.002 in.; the mercury in the limb of the cistern is adjusted at each observation to a constant zero point; the tube is about 0.15 inch diameter.

56. After January 1. 1842, a Standard Barometer, by NEWMAN, was placed in the Observatory. The diameter of the boiled tube is 0.552 in.; the scale is attached to a brass rod, terminating in an ivory point, which, at each observation, is made to meet its image in the mercury of the cistern. The vernier professes to read to 0.002 in., and 0.001 may be estimated; but the graduation is so inexact, as to give changes in error from 0.002 to 0.003 in.

The barometer by NEWMAN was compared indirectly with the standard of the Royal Society, London, by means of one belonging to the DUKE of ARGYLE. The comparisons were made in London.

TABLE 23.—Comparisons of the Duke of Argyle's Standard Barometer with the Standard Barometer of the Royal Society of London.

Royal Society's Standard.			Duke of Argyle's Standard.			Error of Duke of Argyle's Standard.
Flint Glass.	Crown Glass.	Temperature.	Height.	Temperature.	Corrected to Temperature of R. S. Standard.	
in.	in.	°	in.	°	in.	in.
29.280	29.274	36.9	29.302	37.2	29.301	+ 0.024
29.490	29.482	39.0	29.496	39.0	29.496	+ 0.010
29.462	29.454	40.0	29.460	40.6	29.458	+ 0.000
29.252	29.246	41.6	29.256	42.0	29.255	+ 0.006
29.366	29.358	41.3	29.372	42.0	29.370	+ 0.008
29.210	29.204	43.2	29.214	43.5	29.213	+ 0.006

The mean correction of the Duke of Argyle's Barometer to the Royal Society's is ^{in.} - 0.009.

TABLE 24.—Comparisons of the Makerstoun Standard Barometer with the Duke of Argyle's Standard Barometer.

Duke of Argyle's Standard.	Makerstoun Standard.	Makerstoun Standard <i>minus</i> Duke of Argyle's Standard.
in. 30.046	in. 30.050	in. + 0.004
29.596	29.598	+ 0.002
29.594	29.596	+ 0.002
29.172	29.176	+ 0.004
29.508	29.512	+ 0.004
29.552	29.556	+ 0.004
29.224	29.228	+ 0.004
29.446	29.450	+ 0.004
29.562	29.560	- 0.002

The mean correction of the Makerstoun Standard Barometer to the Duke of Argyle's is -0.003 ^{in.}, and, therefore, to the Royal Society's -0.012 ^{in.}.

From seventeen comparisons, the correction of ADIE No. 1 to the Makerstoun standard is -0.005 .

57. The observations are corrected for temperature by SCHUMACHER'S Tables, given in the Report of the Royal Society; those of the mountain barometer are corrected by the constant -0.017 , and of the standard, by -0.012 , the reduction to the Royal Society's standard.

The cistern is 213 feet above the level of the sea.

§ 9. THERMOMETERS.

58. The dry and wet bulb thermometers are by ADIE and SON. The bulbs are 0.3 inch in diameter, and a tenth of a degree can be estimated on the scales. They are placed 4 inches apart, on a wooden slab, the bulbs projecting below it. They were placed, from July 1841 till January 22. 1842, in the middle of a wooden case, the sides and tops of which were formed like Venetian blinds.

The case was quite open below and on the side next the observatory, the thermometers being about 9 inches distant from the middle window, on the north side of the observatory; and after January 22. 1842, from the west window on the same side.* This change was rendered necessary by the stove being brought to the middle of the observatory.

* There is no doubt that these thermometers were placed in a bad position, being open to the effect of radiation from the observatory. This was, to some extent, unavoidable, as there was neither recess nor door on the north wall. Early in 1843, I had the thermometers placed on a revolving case, which could be turned by means of cords and pulleys from within the observatory when required, and left afterwards with a good north exposure.

59. The maximum and minimum register thermometers are also by ADIE and SON. These thermometers, on RUTHERFORD'S construction, were 4 feet above the ground, near the east window, facing the north, and protected from the sun's rays by projecting sides of wood. The roof was of copper, till August 1842, when one of wooden spars, shelving to the south, was substituted, as the sun shone on the copper top at rising and setting in the summer months.

60. The thermometer of the bifilar magnetometer is by ROSS of London, and of the balance magnetometer by ROBINSON.

61. The following table contains the corrections of the thermometer to a standard thermometer by NEWMAN; the comparisons being made in freezing mixtures and water.

TABLE 25.—Corrections of Thermometers to Newman's Standard Thermometer.

Temperature.	Dry.	Wet.	Max.	Min.	Bifilar.	Balance.
16	-0.5	-0.5	-0.1	-0.2	+0.1	-0.2
22	-0.5	-0.5			-0.2	-0.8
32	-0.6	-0.5	-0.1	+0.1	-0.1	-0.4
43	-0.5	-0.4	-0.4	+0.2	-0.3	-0.6
55	-0.4	-0.3	-0.4	+0.3	-0.5	-0.4
61	-0.2	-0.1	-0.4	+0.4	-0.4	-0.3
71	0.0	+0.1	-0.1	+0.5	-0.2	-0.2
80	+0.1	+0.2	+0.1	+0.5	0.0	+0.2
90	+0.1	+0.3			0.0	+0.1

All the readings of the thermometers in this volume have been corrected by the above quantities.

§ 10. RAIN-GAUGES.

62. The rain-gauge A was placed in an inclosed space on the top of the Observatory hill, June 26. 1842. Its funnel mouth is 6.1 inches in diameter, 8 inches above the soil, and 218 feet above the level of the sea. The quantity of rain is measured by pouring it into a graduated glass tube.

The gauge B is placed on the top of the greenhouse. The funnel mouth is 6.7 inches in diameter, 18 feet from the ground, 192 feet above the level of the sea, and 680 feet NNE. of the gauge A. This gauge is sheltered by trees to the E. and NE., and its indications are, therefore, less trustworthy, especially during E. and NE. winds. The quantity of rain received is also affected by gusts of wind deflected from the sloping roof.

The daily observations for this gauge, in the month of May 1842, were lost; the sum for the month will, however, be found in the Abstract.

In the Abstract, the monthly readings of another gauge C are given. This

gauge is placed in the centre of the Makerstoun garden, with a good exposure; the funnel mouth is 6.7 inches in diameter, $6\frac{1}{2}$ feet above the soil, 171 feet above the level of the sea, and about 620 feet N. by E. of the gauge A. The gauges B and C are about 180 feet distant.

The gauges B and C were observed by Mr MACGALL, the head gardener.

§ 11. ANEMOMETER.

63. Previously to August 26. 1842, there was no vane to be relied on, and no instrument for determining the force of the wind before October 21. 1842.

The estimations of direction were generally made with a handkerchief as a flag, and the force was estimated; the scale adopted being, calm 0, and boisterous 6. Owing to the rarity of strong winds, the one extremity of the scale was not well understood, and in the other the estimations were much too high.

64. A vane was erected by Messrs ADIE and SON, on the north wall of the observatory, which, by means of a rod and gearing-wheels, indicated the direction on a dial-plate within the observatory.

65. An anemometer made by Messrs ADIE and SON, and invented by Mr R. ADIE of Liverpool,* was placed at the north-east corner. In this instrument the wind blows down a tube, the opening of which, at the back of the vane, is always presented to the wind. The tube is bent up at the lower extremity into a vessel inverted in a cylinder full of water. This vessel is suspended by a cord passing over a wheel, and is balanced by a weight acting on a spiral. An index attached to the common axle, shews the pressure, on a dial, in pounds of pressure on a square foot of surface, and leaves a moveable index at the maximum. The spiral on which the weight acts is an involute of a circle, in order that the divisions on the dial may be nearly of equal size throughout.

66. Comparisons of estimated pressure, with the indications of the anemometer, shewed that the estimations under 2.0 were nearly equivalent to the same quantities by the anemometer, increasing above that, till 4.0 might probably be equivalent to a pressure of 8.0 pounds.

67. The way in which this instrument is observed is as follows:—About 2^m before the observation hour, the highest pressure shewn by the independent index is registered as the maximum pressure; this index is then put back to zero, and from 7^m to 10^m after, the position which the index has attained is noted as the *present* pressure, and the index again set.

68. It is conceived that, on the whole, this instrument is trustworthy. It is occasionally, however, liable to slight derangements. A cup at the top contains mercury, in which the tubular portion of the vane turns; this fills with rain, which, when frozen, prevents the vane turning its aperture to the wind.

* Described and figured by Dr TRAILL in his Physical Geography.

§ 12. STATE OF THE SKY.

69. After April 27. 1842, the quantity of clouds is estimated ; the whole hemisphere covered with clouds being 10 ; and no clouds, 0.

After the same date, the motions of the clouds were estimated. A marked portion of cloud, which passes nearly through the zenith, is watched till the direction is found in which it seems to run down one corner of the Observatory. About the end of 1843, the points of the compass, referred to each corner of the Observatory, were marked upon the surrounding paling ; before this, the direction was estimated very nearly, as the walls of the Observatory are in the meridian and prime vertical.

70. The nomenclature adopted is that of HOWARD, with a few combinations. The term *scud* refers to that loose, generally amorphous, and often rainy, cloud which is the lowest of all excepting the stratus. The state of the sky is generally observed after the magnetometers, at each observation hour.

71. The remarks on the weather, after May 1. 1842, were too lengthy to print on the same page with the other meteorological observations ; an abstract has been given there, and the original remarks printed in an Appendix.

§ 13. GENERAL AND RECAPITULATORY REMARKS.

72. As there was no computing-room apart from the Observatory, a small copper stove was placed in the south-east anteroom, in order that the latter might be used in the winter months for this purpose. In January 1842, this was removed, and a larger copper stove placed in the position S in the plan, from a belief that it would keep the temperature within the Observatory more uniform.*

73. The mean-time clock is by DENT ; it is kept at Göttingen mean time, the errors being determined by comparisons with the transit clock in the Astronomical Observatory. The rate is always kept very small.

74. The time used throughout this volume is Göttingen mean solar time, astronomical reckoning. The Göttingen time is 49^m 50^s in advance of the Makerstoun time.

75. In the daily observations 1841, the bifilar magnetometer was observed 2½ minutes *after*, and the balance magnetometer 2½ minutes *before*, the minute of the declination observation.

76. During the term-day observations 1841, the bifilar and balance magnetometers were observed alternately 2½ minutes after the minute of declination observation.

* Early in 1843 I discontinued the use of a stove, and ultimately had it removed.

77. In the daily observations 1842, the bifilar magnetometer was observed 2 minutes *after*, and the balance magnetometer 2 minutes *before*, the minute of declination observation.

During the term-day observations 1842, the bifilar magnetometer was observed 2 minutes *after*, and the balance magnetometer 4 minutes *after*, the minute of declination observation.

78. The following is the arrangement of the observers on the term-days.

TABLE 26.—Initials of Observers for each Hour of the Term-Days, from July 1841 till December 1842.

Göttingen Hour.	July.	August.	September.	October.	November.	December.	January.	February.	March.	April.	May.	June.	July.	August.	September.	October.	November.	December.
10	R	B	A	R	B	R	R	B	W*	R	A	D	B	H	A	D	B	D
11	R	B	A	R	B	R	R	B	W	R	A	D	B	H	A	D	B	D
12	H	B	A	R	B	R	R	B	W	R	D	D	B	H	A	D	B	D
13	H	H	H	A	B	R	R	B	W	R	D	D	B	H	A	D	B	D
14	A	H	H	A	A	A	H	A	A	A	B	B	H	A	D	B	C	H
15	A	H	H	A	A	A	H	A	A	A	B	B	H	A	D	B	C	H
16	B	R	R	B	A	A	H	A	A	A	B	B	H	A	D	B	C	H
17	B	R	R	B	A	A	H	A	A	A	B	B	H	A	D	B	C	H
18	R	R	R	B	H	H	B	H	H	H	H	H	D	B	B	H	D	C
19	R	A	B	H	H	H	B	H	H	H	H	H	D	B	B	H	D	C
20	H	A	B	H	R	H	B	R	H	H	H	H	D	B	B	H	D	C
21	H	A	B	H	R	H	B	R	H	H	H	H	D	B	B	H	D	C
22	A	B	A	R	B	B	A	R	R	B	A	A	A	D	H	A	H	B
23	A	B	A	R	B	B	A	R	R	B	A	A	A	D	H	A	H	B
0	B	B	A	A	A	B	A	B	R	B	A	A	A	D	H	A	H	C
1	B	H	H	A	A	B	A	B	W	B	A	A	A	D	H	A	H	B
2	R	H	H	A	H	R	R	A	W	R	D	B	B	A	A	B	B	B
3	R	H	H	A	H	R	R	A	A	R	D	B	B	A	A	B	B	B
4	H	R	R	B	H	H	H	H	A	A	D	H	H	H	H	H	H	B
5	H	R	R	B	H	H	H	H	H	A	D	H	H	H	H	H	H	B
6	A	R	R	B	R	A	B	H	H	H	B	D	A	B	B	D	C	H
7	A	A	B	H	R	A	B	H	H	H	B	D	A	B	B	D	D	H
8	B	A	B	H	R	B	A	R	R	B	H	A	D	D	D	A	D	D
9	B	A	B	H	R	B	A	R	R	B	H	A	D	D	D	A	D	D

The names of the observers to whom the initials belong will be found, § 2.

79. The absolute westerly declination is to be obtained from the observations by adding 24° 20', or by deleting the unit in the hundreds place, and prefixing 25°.

80. All the readings of the bifilar and balance magnetometer, are corrected for temperature by the quantities given in Tables 11 and 18; 300 scale divisions being added to all the bifilar readings.

* Mr WALLACE, of the Edinburgh Observatory.

500 micrometer divisions are added to the readings of the balance magnetometer in September 1841 ; 400 in October and November 1841 ; and 700 in all the other months.

81. In the term-day and extra observations of the bifilar and balance magnetometers, the corrections for temperature are interpolated for the observations in the periods between the thermometer readings.

82. The meteorological observations are made in the period from 2^m before till 7^m after the minute of declination observation.

83. In forming the abstract of the observations, the sums were taken, accidentally, according to the astronomical reckoning.

84. With the exception of Tables VIII. and XV., the other tables of abstracts for the bifilar and balance magnetometer are corrected by the quantities given. (No. 51.)

85. Owing to the fewness of the daily observations, the results are to some extent limited. The remarks on the tables have been confined to pointing out their more prominent features.

86. When the observations for 1844 and 1845, which are made hourly, are reduced, factors may be obtained generally for the approximate conversion of the monthly means of four observations to the monthly means from the twenty-four observations.

87. It should be remembered, in considering the tables of abstracts, that the means for July 1841, are from only 11 days, and for January 1842 from 15 days.

88. On account of adjustments at different periods, several months of the observations of the Force Magnetometers are not comparable with each other. These circumstances are given in the preceding pages ; and in the tables of abstracts, the means which are not comparable with each other are separated by lines.

89. All the computations have been made by myself, or with the aid of my present assistants, Messrs WELSH and HOGG, and each computation has been performed twice by the same or by different individuals.

JOHN A. BROUN.

DAILY OBSERVATIONS

OF

MAGNETOMETERS.

1841 AND 1842.

Göttingen Mean Time of Declination Observation.			DECLINA- TION.	BIFILAR.		BALANCE.		Göttingen Mean Time of Declination Observation.			DECLINA- TION.	BIFILAR.		BALANCE.	
d.	h.	m.		Cor- rected.	Thermo- meter.	Cor- rected.	Thermo- meter.	d.	h.	m.		Cor- rected.	Thermo- meter.	Cor- rected.	Thermo- meter.
July 11	20	0	123.82	469.3	52.5	756.0	52.5	Aug. 4	20	0	129.58	517.3	57.1	766.0	57.6
	23	0	129.67	458.9	53.6	741.0	53.7		23	0	136.63	504.3	57.4	757.7	57.5
July 12	2	0	131.17	483.8	55.7	758.9	55.5	Aug. 5	2	0	142.91	522.4	58.8	748.6	58.2
	5	0	127.48	508.5	61.0	744.3	59.1		5	0	138.93	541.8	60.9	774.1	60.1
	20	0	121.80	466.7	54.1	772.3	54.6		20	0	138.40	510.9	59.2	695.6	59.0
July 13	23	0	128.37	465.6	56.4	737.8	56.6	Aug. 6	23	0	138.40	513.1	60.0	697.9	59.7
	2	0	135.73	488.7	57.3	758.9	57.2		2	0	138.82	515.9	61.9	802.4	61.6
	5	0	133.15	495.1	58.6	788.0	58.3		5	0	145.35	567.7	61.4	809.0	61.0
July 14	20	0	123.48	478.5	54.3	763.8	55.4	Aug. 7	20	0	132.62	518.8	56.6	743.1	56.7
	23	0	128.05	472.7	57.4	750.7	57.2		23	0	139.73	513.3	59.6	721.3	58.7
	2	0	133.42	480.7	60.1	760.0	59.3		2	0	141.70	531.8	61.6	708.4	60.2
July 15	5	0	129.69	495.0	61.5	753.8	60.7	Aug. 8	5	0	135.05	532.4	63.1	779.1	62.2
	20	0	122.18	464.0	55.5	702.6	55.8		20	0	127.23	522.8	56.9	754.1	57.2
	23	0	129.75	462.2	56.5	728.0	56.5		23	0	134.15	521.4	59.3	750.0	59.1
July 16	2	0	141.29	483.9	59.0	754.8	58.6	Aug. 9	2	0	141.73	526.5	61.4	720.3	60.7
	5	0	135.50	499.8	61.6	777.4	60.4		5	0	135.57	537.8	63.6	718.6	62.6
	20	0	124.55	474.6	54.7	759.8	54.7		20	0
July 17	23	0	130.58	468.4	55.4	Aug. 10	23	0	135.82	519.5	57.1	749.7	56.9
	2	0	135.77	483.1	58.5	767.6	58.6		2	0	140.85	530.1	58.9	736.7	58.7
	5	0	133.95	497.9	63.8	804.0	62.2		5	0	135.15	543.2	60.7	737.9	59.7
July 18	20	0	128.96	474.6	54.8	770.1	55.6	Aug. 11	20	0	128.87	522.5	51.9	777.9	52.3
	23	0	133.57	479.7	57.6	778.7	57.7		23	0	135.10	522.6	54.3	762.3	54.1
	2	0	136.75	492.7	61.6	796.4	61.0		2	0	139.15	534.2	56.5	734.5	56.2
July 19	5	0	133.31	494.1	64.3	836.1	63.3	Aug. 12	5	0	135.79	539.5	57.6	748.6	56.8
	20	0		20	0	126.81	525.3	51.6	659.9	52.1
	23	0	132.98	482.6	62.2	780.2	61.7		23	0	134.77	528.9	54.3	729.7	53.8
July 20	2	0	140.47	494.3	67.6	806.5	65.4	Aug. 13	2	0	139.49	531.5	57.5	722.5	56.6
	5	0	137.47	520.6	69.5	807.6	67.8		5	0	138.35	553.8	58.9	720.8	57.7
	20	0	135.82	477.1	58.4	661.5	59.2		20	0	128.92	525.7	50.2	757.5	50.6
July 21	23	0	135.99	444.0	60.9	728.1	61.1	Aug. 14	23	0	134.82	530.5	54.4	729.0	53.8
	2	0	133.11	493.6	63.8	793.4	63.2		2	0	139.12	537.8	58.5	715.5	57.0
	5	0	135.77	498.2	64.7	799.2	63.9		5	0	134.88	543.2	58.6	732.2	57.5
July 22	20	0	123.77	472.3	58.4	738.6	58.3	Aug. 15	20	0	128.10	536.3	55.6	746.7	55.7
	23	0	129.29	460.3	59.3	742.3	59.2		23	0	134.37	530.7	56.4	728.7	56.2
	2	0	136.94	497.1	62.0	749.0	61.9		2	0	141.09	539.7	57.2	718.2	56.7
July 23	5	0	133.25	519.2	62.9	798.0	62.8	Aug. 16	5	0	137.20	547.2	58.1	728.5	57.3
	20	0	129.13	471.3	59.3	720.1	59.7		20	0	129.27	526.1	55.7	700.2	56.2
	23	0	129.47	466.5	58.6	734.1	59.2		23	0	138.52	524.8	58.2	729.6	58.0
July 24	2	0	133.47	475.8	58.9	747.9	59.6	Aug. 17	2	0	144.43	544.7	63.8	667.6	62.5
	5	0	131.33	487.4	59.9	759.2	60.2		5	0	134.90	543.5	68.1	725.6	66.1
	20	0		20	0	136.58	523.9	60.6	712.7	60.7
July 25	23	0	129.42	468.4	55.7	725.4	55.8	Aug. 18	23	0	142.97	524.9	62.2	707.5	62.1
	2	0	134.62	482.9	56.5	729.8	56.4		2	0	141.68	547.1	64.9	716.0	64.0
	5	0	132.40	488.0	58.1	765.7	58.3		5	0	135.08	550.8	65.7	739.5	65.1

BIFILAR. July 11^d—July 23^d $k=0.0001185$ $q=0.000304=2.57$ Scale divisions.
 „ Aug. 4^d—Sept. 7^d 5^h $k=0.0001522$ $q=0.000304=2.00$ Scale divisions.
 BALANCE. July 11^d—July 23^d $k=0.0000127$ $q=0.000073=5.74$ Micrometer divisions.
 „ Aug. 4^d—Aug. 28^d $k=0.0000143$ $q=0.000073=5.10$ Micrometer divisions.

July 15^d 23^h. The Balance reading considerably changed, caused by a spider's thread which was found attached to the magnet. Spider's thread removed. The difference of the readings between the two Micrometers of the Balance has increased about 6 Mic. Div.

July 20^d. A fibre of the suspension thread of the Declinometer found broken; removed carefully.

July 22^d 8^h. The object lens of the right hand Micrometer of the Balance found loose; when screwed tight the difference between the readings of the two Micrometers reverted to its value previously to July 15^d.

July 23^d—Aug 4^d. A carefully prepared thread placed in the Declinometer, from which the torsion was completely removed after hanging a few days with the brass bar attached. The Bifilar and Balance Magnetometers readjusted, the magnets being placed with their poles in directions opposite to that which they previously occupied. See *Introduction*.

DAILY OBSERVATIONS OF MAGNETOMETERS, AUGUST 17—SEPTEMBER 15, 1841. 3

Göttingen Mean Time of Declination Observation.			DECLINA- TION.	BIFILAR.		BALANCE.		Göttingen Mean Time of Declination Observation.			DECLINA- TION.	BIFILAR.		BALANCE.	
				Cor- rected.	Thermo- meter.	Cor- rected.	Thermo- meter.					Cor- rected.	Thermo- meter.		
d.	h.	m.	'	Se. Div.	°	Mic. Div.	°	d.	h.	m.	'	Se. Div.	°	Mic. Div.	°
Aug. 17	20	0	131.30	528.7	53.6	781.5	54.7	Sept. 1	20	0	133.57	543.9	54.6
	23	0	137.21	528.0	56.4	724.4	56.3		23	0	139.35	541.1	57.1
Aug. 18	2	0	141.73	551.5	60.8	694.2	59.7	Sept. 2	2	0	141.65	559.6	60.6
	5	0	137.75	553.3	65.3	712.1	63.1		5	0	136.00	557.9	61.7
	20	0	133.73	534.8	57.4	750.4	57.5		20	0	132.00	542.7	54.2
	23	0	135.57	530.7	59.6	731.8	59.2		23	0
Aug. 19	2	0	Sept. 3	2	0
	5	0	138.05	552.7	67.8	695.3	65.7		5	0
	20	0	127.97	545.0	62.7	705.6	62.7		20	0	129.95	548.9	52.7
	23	0	135.92	541.5	65.5	683.2	64.7		23	0	135.35	534.5	52.3
Aug. 20	2	0	142.05	557.1	69.1	634.5	68.1	Sept. 4	2	0	142.50	548.5	51.4
	5	0	138.23	552.8	70.2	650.7	69.5		5	0	135.48	551.6	50.8
	20	0	130.87	540.2	62.0	714.3	62.7	Sept. 5	20	0	124.23	541.8	47.3	713.7	47.9
	23	0	137.00	533.8	60.4	691.5	61.0		23	0	126.52	539.7	48.6	709.3	48.6
Aug. 21	2	0	145.92	538.3	60.4	703.8	60.7	Sept. 6	2	0	133.37	550.1	52.6	699.0	51.6
	5	0	139.76	549.7	59.9	722.3	60.1		5	0	130.49	560.7	55.6	698.5	54.1
Aug. 22	20	0	138.75	523.3	56.8	683.2	57.3		20	0	123.35	544.5	47.1	711.0	47.6
	23	0	135.15	536.7	58.0	675.2	58.2		23	0	128.40	545.0	49.4	699.9	49.0
Aug. 23	2	0	143.25	541.5	61.6	676.3	61.7	Sept. 7	2	0	133.07	551.0	52.5	688.0	51.3
	5	0	143.57	543.2	63.7	718.5	62.7		5	0	131.27	565.0	54.6	698.0	53.1
	20	0	150.30	504.5	53.6	671.6	54.1		20	0	124.79	506.2	51.1	695.8	51.6
	23	0	137.21	522.0	54.5	709.6	54.9		23	0	128.69	504.6	52.3	699.8	52.1
Aug. 24	2	0	140.56	542.5	57.1	714.1	56.9	Sept. 8	2	0	133.53	514.3	53.6	683.0	53.1
	5	0	136.90	550.5	60.1	695.3	59.7		5	0	129.10	517.5	54.5	693.6	53.7
	20	0	132.27	545.8	56.6	718.8	56.7		20	0	122.64	503.6	46.9	721.8	47.4
	23	0	136.00	544.6	59.3	700.5	58.7		23	0	127.14	499.9	48.7	722.4	49.0
Aug. 25	2	0	141.47	557.9	63.6	656.8	62.2	Sept. 9	2	0	134.17	511.9	52.9	695.7	51.9
	5	0	136.88	555.3	65.7	669.3	64.2		5	0	130.23	520.1	55.7	688.9	54.3
	20	0	130.49	546.4	61.5	691.1	61.2		20	0	123.77	516.6	58.6	681.3	58.0
	23	0	137.57	543.1	64.1	658.4	63.3		23	0	128.17	514.7	60.1	672.9	59.5
Aug. 26	2	0	145.39	552.8	65.5	663.6	64.6	Sept. 10	2	0	134.59	522.4	62.1	655.8	61.2
	5	0	143.11	570.2	66.5	710.3	65.8		5	0	131.03	529.6	62.6	660.4	62.1
	20	0	144.62	535.8	62.1	605.6	62.2		20	0	127.07	514.9	59.0	656.8	58.9
	23	0	138.93	548.3	62.3	676.0	62.2		23	0	128.27	517.7	59.9	665.8	59.5
Aug. 27	2	0	152.00	551.2	65.4	696.6	64.7	Sept. 11	2	0	134.55	525.1	62.1	657.3	61.4
	5	0	139.65	559.3	67.5	734.5	66.3		5	0
	20	0	137.18	545.4	63.0	672.4	63.8	Sept. 12	20	0	127.27	531.3	61.6	590.0	62.2
	23	0	141.78	523.9	64.5	718.3	65.1		23	0	144.15	509.5	63.1	644.2	63.2
Aug. 28	2	0	147.63	554.5	67.6	712.3	67.4	Sept. 13	2	0	139.90	541.0	69.3	655.9	68.4
	5	0	139.72	563.4	69.8	690.6	67.8		5	0	129.49	539.3	73.6	727.8	71.6
Aug. 31	20	0	143.35	508.6	50.1	Sept. 14	20	0	131.45	520.4	61.8	675.8	62.0
	23	0	143.24	535.5	53.1		23	0	135.28	519.5	64.0	674.8	63.1
Sept. 1	2	0	142.08	564.7	57.6	Sept. 15	2	0	135.43	529.5	68.3	652.8	67.0
	5	0	134.35	559.1	58.8		5	0	132.13	532.6	69.5	657.6	68.1

BIFILAR. Aug. 4^d —Sept. 7^d 5^h $k=0.0001522$ $q=0.000304=2.00$ Scale divisions.
 „ Sept. 7^d 20^h —Sept. 30^d $k=0.0001464$ $q=0.000304=2.08$ Scale divisions.
 BALANCE. Aug. 4^d —Aug. 28^d $k=0.0000143$ $q=0.000073=5.10$ Micrometer divisions.
 „ Sept. 5^d —Sept. 30^d $k=0.0000127$ $q=0.000073=5.74$ Micrometer divisions.

Aug. 20^d 22^h. Extra observations made during a thunder storm.
 Aug. 30^d. Mr Simms adjusted the agate planes of the Balance Magnetometer, making them parallel to each other; he also inserted spider's threads in lieu of the silver wire for the bisection crosses, and adjusted the Micrometers.
 Sept. 3^d. Remaining observations for the day not made, on account of alterations being made in the Balance Magnetometer.
 Sept. 7^d 7^h. Torsion circle of Bifilar Magnetometer moved from 114° 50' to 114° 0', in order to bring the readings nearer the middle of the scale.

4 DAILY OBSERVATIONS OF MAGNETOMETERS, SEPTEMBER 15—OCTOBER 15, 1841.

Göttingen Mean Time of Declination Observation.			DECLINA- TION.	BIFILAR.		BALANCE.		Göttingen Mean Time of Declination Observation.			DECLINA- TION.	BIFILAR.		BALANCE.	
				Cor- rected.	Thermo- meter.	Cor- rected.	Thermo- meter.					Cor- rected.	Thermo- meter.		
d.	h.	m.	'	Sc. Div.	°	Mic. Div.	°	d.	h.	m.	'	Sc. Div.	°	Mic. Div.	°
Sept. 15	20	0	132.88	524.5	61.0	660.0	61.2	Sept. 27	20	0	135.52	528.8	55.5	617.3	55.2
	23	0	135.13	518.6	62.5	660.9	62.4		23	0	133.85	523.0	60.9	633.0	59.2
Sept. 16	2	0	139.40	527.8	64.2	655.3	63.3	Sept. 28	2	0	138.55	532.2	64.4	631.6	62.6
	5	0	134.25	531.9	66.5	670.2	65.3		5	0	133.04	537.7	63.7	659.0	62.5
	20	0	133.17	518.9	55.1	644.8	55.7		20	0	136.32	532.4	56.0	575.5	56.2
	23	0	133.95	517.5	56.8	677.7	56.3		23	0	135.30	506.5	56.4	680.4	56.5
Sept. 17	2	0	138.48	533.8	63.4	653.7	61.4	Sept. 29	2	0	137.47	536.3	61.1	635.3	59.7
	5	0	133.77	541.7	66.5	666.1	64.5		5	0	133.85	538.9	63.1	754.8	61.6
	20	0	128.89	522.3	54.6	677.4	55.1		20	0	127.65	527.8	56.1	602.5	56.2
	23	0	133.90	510.6	54.8	679.4	55.2		23	0	132.95	524.9	57.1	639.2	56.7
Sept. 18	2	0	140.10	528.4	56.9	666.7	56.2	Sept. 30	2	0	137.48	540.3	63.2	627.0	61.7
	5	0	135.82	526.7	58.2	692.3	57.2		5	0	128.80	545.4	63.7	681.2	62.2
	20	0	Oct. 6	20	0	128.25	505.2	50.6	653.7	50.9
	23	0	133.22	510.3	56.6	665.9	56.2		23	0	132.50	504.2	51.1	642.3	50.9
Sept. 19	2	0	140.93	530.3	61.6	645.8	59.9	Oct. 7	2	0	135.46	524.6	56.1	644.6	54.4
	5	0	140.36	548.7	65.8	709.1	64.1		5	0	136.83	531.2	56.6	666.6	56.5
	20	0	129.47	526.9	60.2	675.6	59.9		20	0	127.67	516.9	51.5	625.2	51.5
	23	0	135.20	516.6	60.5	670.1	60.2		23	0	133.40	511.8	53.6	650.3	52.9
Sept. 20	2	0	142.27	526.7	60.4	665.7	60.2	Oct. 8	2	0	137.25	517.5	56.4	643.5	56.2
	5	0	136.52	536.2	60.6	693.4	60.2		5	0	121.70	555.5	55.6	735.3	55.4
	20	0	131.88	522.0	53.0	704.7	52.9		20	0	127.57	513.5	49.4	661.2	49.5
	23	0	135.19	513.5	54.4	683.7	53.8		23	0	127.28	515.4	52.1	666.7	50.7
Sept. 21	2	0	140.40	525.0	58.8	665.9	57.4	Oct. 9	2	0	131.51	533.4	55.5	649.3	54.0
	5	0	136.83	529.7	59.6	675.7	58.3		5	0	128.93	549.7	56.5	706.7	55.7
	20	0	132.11	522.0	52.4	687.8	52.1	Oct. 10	20	0	131.24	524.1	52.6	665.6	52.1
	23	0	135.68	517.3	54.5	671.7	53.8		23	0	128.34	533.1	55.9	662.5	54.8
Sept. 22	2	0	140.13	526.7	56.0	648.4	55.3	Oct. 11	2	0	131.68	536.0	58.5	638.2	57.2
	5	0	135.20	536.0	56.4	683.1	55.7		5	0	127.81	544.7	59.2	638.7	58.0
	20	0	132.02	532.9	62.4	685.3	62.3		20	0	124.62	504.9	48.6	651.1	48.9
	23	0	137.28	515.0	60.6	646.2	60.7		23	0	125.15	520.5	47.6	661.0	48.5
Sept. 23	2	0	141.29	529.0	60.8	650.2	61.7	Oct. 12	2	0	130.58	541.4	52.9	665.9	51.8
	5	0	137.88	540.5	63.5	649.9	63.0		5	0	125.81	552.2	56.8	662.6	55.2
	20	0		20	0	121.67	537.0	47.6	656.3	48.1
	23	0	136.20	525.1	58.0	647.8	57.7		23	0	125.13	533.5	50.3	654.7	49.4
Sept. 24	2	0	140.75	531.1	58.2	642.1	57.8	Oct. 13	2	0	129.95	542.3	51.8	647.6	51.0
	5	0	144.42	546.1	60.7	665.1	59.6		5	0	125.39	542.4	50.5	662.4	50.1
	20	0	133.77	516.8	55.4	575.5	55.4		20	0	125.70	537.4	49.8	641.1	49.5
	23	0	144.93	497.6	58.0	625.6	57.3		23	0	125.03	542.7	54.4	625.9	53.5
Sept. 25	2	0	153.14	664.3	62.0	916.3	60.2	Oct. 14	2	0	129.85	541.8	56.8	630.8	55.7
	5	0	130.45	860.2	65.0	909.7	63.2		5	0	125.40	549.1	57.3	640.7	56.5
Sept. 26	20	0	142.08	508.7	51.6	645.5	51.6		20	0	126.74	534.0	51.4	607.8	51.4
	23	0	138.40	495.6	54.0	806.8	5.13		23	0	130.56	535.9	53.9	645.7	54.0
Sept. 27	2	0	139.92	526.0	57.7	819.6	56.0	Oct. 15	2	0	131.20	536.8	56.0	646.3	56.0
	5	0	132.20	547.1	59.2	867.6	57.8		5	0	128.82	558.8	55.4	656.8	55.7

BIFILAR. Sept. 7^d 20^h—Sept. 30^d $k=0.0001464$ $q=0.000304=2.08$ Scale divisions.
 „ Oct. 6^d —Oct. 19^d 20^h $k=0.0001303$ $q=0.000304=2.34$ Scale divisions.
 BALANCE. Sept. 5^d —Sept. 30^d $k=0.0000127$ $q=0.000073=5.74$ Micrometer divisions.
 „ Oct. 6^d —Nov. 30^d $k=0.0000118$ $q=0.000073=6.20$ Micrometer divisions.

Sept. 18^d—19^d. Sunday.
 Sept. 25^d 2^h. Bifilar reading approximate. Scale out of the field.
 Sept. 25^d 4^h. Observations made during an extraordinary disturbance, at which time the torsion circle of the Bifilar was frequently turned, but left ultimately at its usual position.
 Oct 2^d. Balance magnet reversed, for the purpose of determining the deviation of the bisection crosses from the magnetic axis.
 Oct. 1^d—6^d. Wires of Bifilar Magnetometer found to have a twist. Wires removed, and, after several trials, new ones inserted which were free of twist. Adjustment completed. Torsion circle left reading 290° 0'.

DAILY OBSERVATIONS OF MAGNETOMETERS, OCTOBER 15—NOVEMBER 13. 1841.

Göttingen Mean Time of Declination Observation.			DECLINA- TION.	BIFILAR.		BALANCE.		Göttingen Mean Time of Declination Observation.			DECLINA- TION.	BIFILAR.		BALANCE.	
				Cor- rected.	Thermo- meter.	Cor- rected.	Thermo- meter.					Cor- rected.	Thermo- meter.		
d.	h.	m.	'	Sc. Div.	°	Mic. Div.	°	d.	h.	m.	°	Sc. Div.	°	Mic. Div.	°
Oct. 15	20	0	123.99	538.8	46.1	639.5	46.1	Oct. 29	20	0	134.48	496.4	44.3	650.2	44.5
	23	0	128.90	532.3	47.3	653.1	47.1		23	0	137.08	499.8	47.6	655.4	46.5
Oct. 16	2	0	131.22	542.4	50.9	652.5	49.8	Oct. 30	2	0	139.75	506.8	50.5	651.1	49.2
	5	0	130.23	544.2	50.1	701.3	49.8		5	0	137.08	506.6	50.0	641.6	49.1
Oct. 17	20	0	129.10	536.0	46.4	632.4	45.4	Oct. 31	20	0	134.35	502.8	45.1	639.6	45.1
	23	0	129.29	537.5	46.9	639.7	46.6		23	0	135.75	499.9	45.8	647.5	45.6
Oct. 18	2	0	134.85	546.8	50.6	639.4	49.8	Nov. 1	2	0	138.23	507.3	50.6	637.7	49.1
	5	0	132.47	552.2	51.0	670.6	50.1		5	0	136.34	512.5	49.5	640.5	48.9
	20	0	125.19	541.6	40.0	654.1	40.8		20	0	138.34	500.4	40.3	631.3	41.0
	23	0	129.30	535.8	41.7	646.9	41.3	Nov. 2	20	0	135.65	494.2	40.2	639.9	40.9
Oct. 19	2	0	133.07	551.9	50.6	634.6	48.5	Nov. 2	2	0	138.87	505.2	44.1	644.3	43.5
	5	0	129.05	552.6	51.6	659.9	50.1		5	0	136.65	511.3	48.6	646.2	46.6
	20	0	128.40	539.8	46.6	642.6	46.6		20	0	134.43	506.5	40.9	632.8	41.3
	23	0	129.69	502.2	51.1	639.2	49.2	Nov. 3	20	0	136.52	501.2	44.7	626.6	44.1
Oct. 20	2	0	130.95	505.6	54.0	629.5	52.6	Nov. 3	2	0	138.03	507.8	47.3	630.5	45.8
	5	0	131.17	506.5	52.6	669.8	52.1		5	0	135.68	515.0	47.0	635.3	46.1
	20	0	125.94	498.7	50.1	508.1	50.6		20	0	128.17	512.4	39.7	502.1	40.4
	23	0	132.44	490.6	49.4	612.5	49.1	Nov. 4	20	0	139.47	482.6	41.5	625.9	40.9
Oct. 21	2	0	129.15	498.7	52.6	755.3	52.1	Nov. 4	2	0	147.03	519.8	46.2	709.6	44.6
	5	0	130.80	514.1	54.3	680.2	53.4		5	0	139.53	503.5	47.6	734.9	46.1
	20	0		20	0	139.35	499.5	38.3	608.6	39.0
	23	0	129.29	486.7	41.7	660.5	42.1	Nov. 5	20	0	146.30	491.2	40.6	683.9	40.0
Oct. 22	2	0	132.67	501.3	45.1	653.1	44.5	Nov. 5	2	0	149.77	506.3	45.4	687.2	43.6
	5	0	128.60	503.2	45.2	652.8	45.1		5	0	134.06	510.2	46.7	718.6	45.2
	20	0	130.96	501.2	43.2	658.6	43.2	Nov. 7	20	0	134.86	509.8	50.4	612.4	49.6
	23	0	131.58	496.8	47.6	660.0	45.6		23	0	137.50	497.1	53.4	629.8	51.8
Oct. 23	2	0	134.77	504.9	49.8	647.0	48.1	Nov. 8	2	0	137.34	515.4	57.3	608.9	55.7
	5	0	129.72	507.4	49.6	650.1	48.6		5	0	135.52	508.9	56.0	637.5	55.2
Oct. 24	20	0	145.59	491.3	44.6	544.4	44.5		20	0	136.45	524.2	51.4	597.7	49.9
	23	0	139.33	495.2	45.4	652.5	45.0	Nov. 9	20	0	133.45	507.3	50.6	622.4	50.1
Oct. 25	2	0	144.60	648.9	48.5	1144.4	47.6	Nov. 9	2	0	136.37	512.2	50.6	626.7	50.4
	5	0	127.14	554.9	48.4	1062.9	47.6		5	0	134.46	511.9	50.4	660.7	50.1
	20	0	139.72	483.5	41.7	611.3	42.0		20	0	128.55	510.2	49.7	603.4	49.1
	23	0	140.13	493.4	42.3	715.8	42.1	Nov. 10	20	0	132.31	508.5	51.0	629.2	49.9
Oct. 26	2	0	141.70	497.0	46.4	727.3	45.4	Nov. 10	2	0	135.55	506.8	51.6	627.5	51.1
	5	0	123.39	480.5	46.2	905.5	45.6		5	0	133.38	508.9	51.3	627.7	50.8
	20	0	138.47	495.1	40.9	667.5	41.0		20	0	129.32	509.5	45.9	608.1	46.2
	23	0	139.33	487.0	43.5	704.8	42.5	Nov. 11	20	0	130.07	511.8	46.6	609.3	46.4
Oct. 27	2	0	142.04	507.9	51.1	686.5	48.5	Nov. 11	2	0	137.54	504.6	47.6	629.2	47.1
	5	0	137.81	500.0	49.9	689.9	48.8		5	0	133.04	501.8	48.4	669.2	47.6
	20	0	134.59	493.4	43.1	562.4	43.0		20	0	133.28	510.2	40.4	626.4	40.6
	23	0	136.65	497.5	45.4	650.0	44.9	Nov. 12	20	0	131.51	500.7	42.4	645.2	41.6
Oct. 28	2	0	142.88	498.4	50.9	672.5	49.6	Nov. 12	2	0	134.73	504.0	43.3	655.3	42.7
	5	0	136.45	513.0	50.4	704.8	50.1		5	0	131.27	511.6	43.4	668.9	43.0
	20	0	134.55	495.4	39.7	651.4	40.5		20	0	131.50	500.8	35.8	645.1	36.5
	23	0	137.57	497.4	44.2	668.0	43.7	Nov. 13	20	0	133.73	503.1	37.1	606.2	37.2
Oct. 29	2	0	138.52	504.1	47.9	654.8	46.8	Nov. 13	2	0	133.04	508.1	43.2	653.6	41.5
	5	0	135.79	512.4	49.1	639.7	47.8		5	0	131.00	505.9	44.1	649.9	43.0

BIFILAR. Oct. 6^d — Oct. 19^d 20^h $k=0.0001303$ $q=0.000304=2.34$ Scale divisions.

„ Oct. 19^d 23^h — Dec. 31^d $k=0.0001248$ $q=0.000304=2.34$ Scale divisions.

BALANCE. Oct. 6^d — Nov. 30^d $k=0.0000118$ $q=0.000073=6.20$ Micrometer divisions.

Oct. 19^d 21^h. The readings of the Bifilar having altered, so that the middle of the scale was no longer the mean position, the arm of the torsion circle was moved 50'. Torsion circle left reading 289° 10'.

6 DAILY OBSERVATIONS OF MAGNETOMETERS, NOVEMBER 14. 1841—JANUARY 17. 1842.

Göttingen Mean Time of Declination Observation.			DECLINA- TION.	BIFILAR.		BALANCE.		Göttingen Mean Time of Declination Observation.			DECLINA- TION.	BIFILAR.		BALANCE.	
				Cor- rected.	Thermo- meter.	Cor- rected.	Thermo- meter.					Cor- rected.	Thermo- meter.		
d.	h.	m.	'	Sc. Div.	°	Mic. Div.	°	d.	h.	m.	'	Sc. Div.	°	Mic. Div.	°
Nov. 14	20	0	132.64	500.2	31.9	651.0	32.1	Nov. 22	20	0	130.22	507.4	36.8	632.1	37.0
	23	0	131.24	500.2	32.6	656.9	32.5		23	0	126.23	499.3	38.1	638.5	37.7
Nov. 15	2	0	132.30	505.6	35.6	663.7	34.6	Nov. 23	2	0	131.20	496.7	39.7	650.0	39.1
	5	0	130.15	506.9	35.8	660.2	35.0		5	0	127.57	503.0	40.5	662.0	40.0
	20	0	129.36	498.5	30.3	656.8	30.6		20	0	127.48	505.2	38.2	635.1	38.3
	23	0	129.67	504.5	33.5	660.7	32.6		23	0	129.18	503.6	40.7	636.7	39.8
Nov. 16	2	0	130.90	513.4	42.4	637.2	39.9	Nov. 24	2	0	132.10	498.6	44.7	652.2	43.7
	5	0	129.07	513.6	43.4	633.1	41.5		5	0	129.00	505.1	44.5	650.0	43.5
	20	0	128.38	502.8	30.8	643.6	31.1		20	0	125.58	505.2	36.8	627.1	37.2
	23	0	131.67	500.6	31.4	641.8	31.2		23	0	128.15	503.6	36.8	617.0	36.7
Nov. 17	2	0	134.59	507.0	41.0	646.9	38.7	Nov. 25	2	0	130.10	517.1	45.4	615.2	43.3
	5	0	132.33	514.4	46.2	634.6	44.0		5	0	127.68	515.0	48.5	611.0	46.8
	20	0	129.07	493.1	27.9	650.3	28.5		20	0	126.92	499.9	35.0	639.9	35.7
	23	0	132.22	498.1	27.8	647.9	27.9		23	0	128.05	502.1	35.5	638.8	35.5
Nov. 18	2	0	133.00	520.6	36.3	646.2	34.6	Nov. 26	2	0	132.05	514.9	42.5	632.1	41.0
	5	0	132.84	518.7	37.3	655.8	35.7		5	0	128.63	517.7	48.6	626.9	45.1
	20	0	148.57	440.7	31.9	580.8	32.1		20	0	129.10	510.5	46.6	634.2	47.2
	23	0	139.16	499.3	34.1	706.8	33.1		23	0	130.83	507.7	46.6	610.3	46.3
Nov. 19	2	0	Nov. 27	2	0	131.90	512.3	49.8	606.0	48.8
	5	0	134.12	509.6	44.2	727.1	42.0		5	0	131.82	511.8	50.4	625.2	49.1
	20	0	132.11	491.2	32.7	607.8	33.3	Nov. 28	20	0	129.03	505.7	39.8	633.2	40.2
	23	0	135.28	468.1	32.9	704.6	32.9		23	0	129.49	505.1	41.2	624.7	40.8
Nov. 20	2	0	136.40	502.8	36.9	752.5	36.0	Nov. 29	2	0	132.30	516.1	48.0	613.6	46.4
	5	0	129.00	508.6	39.7	725.0	38.3		5	0	129.98	516.7	50.6	612.2	49.1
Nov. 21	20	0	126.78	503.9	35.3	659.4	35.5		20	0	129.63	511.8	45.3	604.5	45.3
	23	0	129.95	494.8	36.4	658.0	36.0		23	0
Nov. 22	2	0	131.47	507.1	38.7	650.4	38.0	Nov. 30	2	0	128.80	516.2	49.1	609.0	47.7
	5	0	129.30	503.2	40.7	678.5	39.5		5	0	127.83	516.0	49.9	606.7	48.8

1842.

Jan. 12	20	0	127.32	510.5	40.0	922.1	41.5	Jan. 14	20	0	127.78	516.7	40.1	944.3	41.0
	23	0	130.40	507.4	39.2	950.0	40.5		23	0	128.83	517.5	43.0	943.0	44.0
Jan. 13	2	0	130.27	519.4	44.6	935.4	45.9	Jan. 15	2	0	132.15	526.9	48.1	910.3	48.9
	5	0	130.52	518.9	46.0	941.2	47.6		5	0	130.13	522.2	47.7	924.3	48.5
	20	0	127.77	509.0	35.1	952.5	35.6	Jan. 16	20	0	128.25	513.4	34.5	964.0	34.3
	23	0	130.09	510.7	35.6	967.2	36.0		23	0	129.40	508.0	37.3	981.1	37.1
Jan. 14	2	0	130.58	525.5	44.6	939.8	44.6	Jan. 17	2	0	131.95	521.8	45.2	937.5	44.6
	5	0	128.98	523.0	45.6	938.9	45.8		5	0	129.72	521.9	48.6	927.9	47.9

BALANCE. Oct. 6^d —Nov. 30^d $k=0.000118$ $q=0.000073=6.20$ Micrometer divisions.
 „ Jan. 12^d —Jan. 22^d $k=0.000127$ $q=0.000073=5.75$ Micrometer divisions.

Dec. 4^d. The declination magnet found to have untwisted the suspension roller, to have sunk down and rested on the copper ring, which had severed some of the fibres of the suspension thread. Thread removed, and a new one prepared.

Dec. 6^d. Fibres of the new thread found unequally stretched.

Dec. 8^d. A satisfactory thread obtained, which was attached to the suspension roller, and the torsion removed.

Dec. 20^d. On Mr Russell's return from Edinburgh he found the thread so much stretched as to bring the stirrup in contact with the copper ring; it was therefore wound up a little, and the torsion removed, preparatory to the term-day observations.

Dec. 23^d 0^b. (Term day.) Declination magnet again found in contact with the copper ring, from the stretching of the thread. Magnet wound up.

Dec. 28^d. The short scale removed from the declination magnet, and a long one attached. (Torsion removed?)

Jan. 1^d et seq. Observations made to determine the temperature correction for the Balance magnet. Instrument readjusted.

Göttingen Mean Time of Declination Observation.			DECLINA- TION.	BIFILAR.		BALANCE.		Göttingen Mean Time of Declination Observation.			DECLINA- TION.	BIFILAR.		BALANCE.	
				Cor- rected.	Thermo- meter.	Cor- rected.	Thermo- meter.					Cor- rected.	Thermo- meter.		
h.	h.	m.	'	Sc. Div.	°	Mic. Div.	°	d.	h.	m.	'	Sc. Div.	°	Mic. Div.	°
Jan. 17	20	0	128-34	523-0	37-3	939-9	38-8	Jan. 31	20	0	128-72	525-4	43-7	906-4	44-3
	23	0	127-03	515-9	39-8	959-3	41-7		23	0	125-79	520-2	44-5	920-8	45-0
Jan. 18	2	0	128-14	516-3	43-9	946-9	44-5	Feb. 1	2	0	129-70	520-2	53-6	896-7	53-8
	5	0	127-60	510-0	46-2	993-7	46-6		5	0	125-97	535-5	52-1	982-6	52-3
	20	0	127-58	513-4	39-2	947-1	39-8		20	0	123-40	520-6	49-9	908-7	50-6
	23	0	129-30	512-7	43-2	967-4	43-2		23	0	127-25	509-0	50-6	910-8	51-1
Jan. 19	2	0	527-4	52-7	946-6	52-6	Feb. 2	2	0	130-82	528-2	54-6	930-7	54-9
	5	0	526-0	52-1	948-0	52-2		5	0	130-40	515-1	56-1	923-5	56-7
	20	0	522-3	57-8	940-7	59-4		20	0	123-95	510-0	42-4	921-9	42-5
	23	0	511-9	53-5	955-6	55-3		23	0	126-90	513-9	42-7	938-9	43-8
Jan. 20	2	0	524-9	58-8	947-4	60-9	Feb. 3	2	0	131-43	521-1	49-2	929-5	49-1
	5	0	525-5	59-6	955-5	61-2		5	0	125-42	526-7	53-9	905-1	53-2
Jan. 21	20	0	517-6	46-9	973-8	49-8		20	0	124-43	520-1	48-5	946-0	49-4
	23	0	504-4	44-3	971-2	45-4		23	0	125-97	517-2	48-6	919-7	49-6
Jan. 22	2	0	517-2	46-6	967-7	49-0	Feb. 4	2	0	132-67	524-2	51-6	914-5	52-0
	5	0	522-4	48-8	963-9	51-1		5	0	130-83	526-9	53-4	911-9	54-1
Jan. 23	20	0		20	0	125-35	518-6	47-1	920-7	48-1
	23	0	508-8	33-9	978-2	34-5		23	0	127-03	512-2	46-3	945-9	47-9
Jan. 24	2	0	525-4	44-2	940-4	44-1	Feb. 5	2	0	131-85	518-2	50-9	913-9	51-1
	5	0	523-4	48-3	958-9	48-1		5	0	128-43	523-0	51-6	912-0	52-1
	20	0	508-7	38-5	941-1	39-8	Feb. 6	20	0	130-90	504-7	31-9	906-6	32-1
	23	0	513-4	41-6	983-5	41-4		23	0	128-52	505-9	34-8	945-9	35-3
Jan. 25	2	0	530-5	49-9	940-1	50-1	Feb. 7	2	0	139-60	507-8	42-7	939-3	42-5
	5	0	522-0	51-0	948-8	50-8		5	0	135-42	530-9	49-0	931-4	48-2
	20	0	514-5	42-7	948-7	44-3		20	0	126-62	515-3	43-9	921-6	45-1
	23	0	512-6	44-6	970-4	44-6		23	0	132-45	514-6	45-6	925-3	45-8
Jan. 26	2	0	513-8	43-8	967-4	45-4	Feb. 8	2	0	134-08	520-4	49-4	907-8	49-1
	5	0	519-7	45-6	957-1	47-1		5	0	132-45	525-0	53-8	900-8	53-6
	20	0	518-1	41-7	964-5	42-5		20	0	132-00	519-1	46-6	920-9	48-1
	23	0	515-4	43-3	970-5	44-1		23	0	130-93	512-0	45-1	922-9	46-5
Jan. 27	2	0	525-9	48-4	935-0	48-4	Feb. 9	2	0	136-00	523-5	48-6	924-2	49-6
	5	0	529-0	50-5	935-2	50-1		5	0	133-40	524-5	52-6	913-4	53-1
	20	0	125-30	515-4	44-6	948-0	46-0		20	0	131-49	522-2	48-3	914-0	48-6
	23	0	126-00	519-6	45-6	948-2	45-6		23	0	133-44	519-3	49-1	914-2	49-6
Jan. 28	2	0	127-83	529-2	49-1	933-1	49-1	Feb. 10	2	0	137-41	528-2	51-5	909-6	51-8
	5	0	127-70	529-7	50-6	931-9	50-4		5	0	134-35	528-4	52-6	916-9	52-6
	20	0	130-75	521-2	44-6	926-5	45-8		20	0	132-10	522-2	50-6	891-8	51-4
	23	0	129-47	522-7	47-1	929-9	48-5		23	0	131-73	520-2	52-6	899-1	53-5
Jan. 29	2	0	133-31	521-5	50-6	907-6	51-1	Feb. 11	2	0	138-30	521-5	54-1	879-5	54-7
	5	0	130-35	521-4	52-1	916-4	52-6		5	0	137-32	530-7	53-1	904-8	53-2
Jan. 30	20	0	127-83	517-5	38-7	931-2	39-0		20	0	131-65	515-3	59-6	758-6	60-7
	23	0	128-41	511-4	39-7	946-2	39-9		23	0	134-47	511-2	56-1	852-3	57-3
Jan. 31	2	0	131-96	519-0	44-9	921-3	45-9	Feb. 12	2	0	139-70	530-6	56-8	871-0	58-4
	5	0	129-01	527-1	48-1	914-5	47-6		5	0	139-05	530-2	57-0	905-4	58-2

BIFILAR. $k=0.0001248$ $q=0.000304=2.44$ Scale divisions.
 BALANCE. Jan. 12^d—Jan. 22^d $k=0.0000127$ $q=0.000073=5.75$ Micrometer divisions.
 „ Jan. 23^d—March 21^d 5^h $k=0.0000140$ $q=0.000073=5.20$ Micrometer divisions.

Jan 19^d 2^h. Two fibres of the suspension thread of the Declinometer found broken; the loose fibres removed, but the plane of detorsion had evidently varied considerably.

Jan. 20^d 6^h. Suspension thread of Declinometer broke away fibre by fibre during the term observations.

Jan. 21^d. Subsequent circumstances inclined Mr Russell to believe that the stretching and breaking of the fibres alluded to above must have arisen from the silk being defective at that part of the reel from which the threads were formed.

A new thread prepared. It was allowed to stretch for several days, in consequence of the breaking of the last. The torsion was then removed. Torsion circle reading 280°.

Göttingen Mean Time of Declination Observation.			DECLINA- TION.	BIFILAR.		BALANCE.		Göttingen Mean Time of Declination Observation.			DECLINA- TION.	BIFILAR.		BALANCE.	
				Cor- rected.	Thermo- meter.	Cor- rected.	Thermo- meter.					Cor- rected.	Thermo- meter.		
d.	h.	in.	'	Sc. Div.	°	Mic. Div.	°	d.	h.	m.	'	Sc. Div.	°	Mic. Div.	°
Feb. 13	20	0	132-17	518-3	39-2	920-6	39-0	Feb. 25	20	0	131-30	524-2	53-6	860-7	55-8
	23	0	130-96	510-7	39-2	931-5	39-5		23	0	134-58	515-1	51-4	885-7	53-4
Feb. 14	2	0	137-17	518-7	41-2	924-8	40-8	Feb. 26	2	0	136-30	525-6	54-2	879-5	56-1
	5	0	133-24	526-4	44-5	923-8	44-0		5	0	133-55	532-2	58-3	859-5	59-9
	20	0	130-10	526-8	50-4	889-4	50-6	Feb. 27	20	0	130-73	518-0	38-7	953-2	38-8
	23	0	130-33	521-7	51-0	899-1	51-5		23	0	134-25	513-8	42-7	911-3	43-1
Feb. 15	2	0	134-90	526-0	54-6	885-5	54-7	Feb. 28	2	0	136-92	527-0	50-1	863-6	49-4
	5	0	132-80	533-9	58-8	868-9	59-4		5	0
	20	0	129-82	519-6	48-6	909-3	50-1	Mar. 1	20	0
	23	0	131-78	518-0	49-6	906-7	49-9		23	0
Feb. 16	2	0	135-02	527-9	52-9	887-3	52-6	Mar. 2	2	0	139-10	510-4	41-2	919-6	41-4
	5	0	134-42	531-0	55-6	888-3	55-5		5	0	132-80	520-2	41-2	948-8	41-4
	20	0	129-87	514-3	47-6	896-2	48-6		20	0	128-98	515-8	38-8	903-3	39-0
	23	0	132-33	514-9	48-6	920-8	49-1		23	0	131-92	513-6	40-4	906-6	40-5
Feb. 17	2	0	140-30	514-5	51-4	926-1	51-5	Mar. 3	2	0	136-62	521-1	45-2	890-4	44-6
	5	0	118-15	531-6	52-9	1065-4	53-1		5	0	131-27	531-1	48-1	890-9	48-0
	20	0	130-75	526-8	50-6	905-1	51-1		20	0	131-52	522-1	47-1	880-8	47-1
	23	0	138-49	514-8	50-1	911-5	50-8		23	0	134-79	517-3	48-6	877-1	49-2
Feb. 18	2	0	140-52	533-0	53-9	909-7	54-1	Mar. 4	2	0	134-35	525-6	51-6	862-2	52-1
	5	0	121-33	539-5	55-8	1020-2	55-7		5	0	132-62	531-7	54-4	864-9	54-7
	20	0	133-62	518-9	49-3	910-9	49-9		20	0	128-63	516-8	45-1	892-6	46-2
	23	0	135-73	517-5	49-8	921-6	50-1		23	0	130-60	523-2	47-1	890-9	48-0
Feb. 19	2	0	136-35	514-2	51-6	947-4	51-6	Mar. 5	2	0	134-99	525-4	52-6	866-3	52-4
	5	0	135-57	517-4	52-5	963-7	52-3		5	0	135-70	537-5	52-8	911-5	52-6
Feb. 20	20	0	511-2	43-6	907-8	43-5	Mar. 6	20	0	128-77	520-1	42-7	896-9	43-0
	23	0	940-0	44-8		23	0	129-95	514-9	45-8	897-5	46-1
Feb. 21	2	0	522-4	48-6	922-0	48-6	Mar. 7	2	0	132-33	528-0	52-0	860-5	51-1
	5	0		5	0	128-90	530-4	52-1	880-7	52-2
	20	0	511-4	38-7	923-0	39-5		20	0	128-10	524-1	49-1	875-8	49-9
	23	0	513-3	39-9	951-9	40-6		23	0
Feb. 22	2	0	528-7	46-6	906-8	46-5	Mar. 8	2	0	132-20	528-4	53-0	857-9	52-9
	5	0	528-1	51-1	895-0	49-8		5	0	132-30	531-8	53-1	889-3	52-6
	20	0	515-9	43-2	937-4	44-0		20	0	124-10	522-2	44-5	893-0	45-1
	23	0	516-8	45-1	924-2	45-1		23	0	128-27	514-7	45-1	895-0	46-1
Feb. 23	2	0	524-6	49-6	908-0	48-9	Mar. 9	2	0	131-25	525-1	48-1	868-5	48-6
	5	0	526-0	49-8	888-0	49-6		5	0	121-23	527-5	50-1	905-2	49-6
	20	0	525-2	47-7	873-9	48-9		20	0	123-87	515-3	42-7	893-2	44-0
	23	0	518-9	48-1	895-3	49-2		23	0	125-80	512-1	44-5	907-7	45-1
Feb. 24	2	0	542-6	52-6	869-3	53-1	Mar. 10	2	0	131-15	527-7	48-9	872-4	48-9
	5	0	527-6	55-1	969-7	54-6		5	0	127-63	528-0	49-9	869-4	49-1
	20	0	506-7	42-7	972-2	43-5		20	0	124-63	519-4	43-7	898-0	44-6
	23	0	510-5	43-7	958-6	44-0		23	0	127-21	513-6	45-6	894-4	45-9
Feb. 25	2	0	522-7	45-9	925-4	46-1	Mar. 11	2	0	132-33	521-1	48-6	868-3	49-1
	5	0	526-9	48-6	929-5	48-2		5	0	127-80	534-6	52-6	857-6	52-5

BIFILAR. $k=0\cdot0001248$ $q=0\cdot000304=2\cdot44$ Scale divisions.
BALANCE. Jan. 23^d—March 21^d 5^h $k=0\cdot0000140$ $q=0\cdot000073=5\cdot20$ Micrometer divisions.

Feb. 20^d. Torsion suspected in Declinometer thread. Torsion tried, estimated at 10°. Circle turned to 270°. This torsion is in an opposite direction from what was suspected. Left with brass bar suspended.

Feb. 21^d. The bar had come to rest 50° or 60° to the W. of north; it was allowed to hang for a day or two, when it was found still in the same position; so that the estimation of Feb. 20^d was probably inaccurate.

Feb. 25^d. Torsion removed. Circle reading 330° 30'. It seemed to Mr Russell that the shifting of the magnet, for the purpose of making the Dip observation, was, in some way, connected with this change of the plane of detorsion.

Göttingen Mean Time of Declination Observation.			DECLINA- TION.	BIFILAR.		BALANCE.		Göttingen Mean Time of Declination Observation.			DECLINA- TION.	BIFILAR.		BALANCE.	
				Cor- rected.	Thermo- meter.	Cor- rected.	Thermo- meter.					Cor- rected.	Thermo- meter.		
Mar. 11	d. h. m.			Sec. Div.	°	Mic. Div.	°	Mar. 24	d. h. m.			Sec. Div.	°	Mic. Div.	°
	20 0	125-47	516-6	45-1	866-0	46-9		Mar. 24	20 0	125-12	515-9	48-9	859-5	49-9	
	23 0	127-40	514-4	47-1	893-0	47-6		Mar. 24	23 0	129-75	507-2	51-3	874-9	51-9	
Mar. 12	2 0	132-10	529-5	52-1	861-6	51-6		Mar. 25	2 0	
	5 0	127-85	534-5	53-5	856-3	52-6		Mar. 25	5 0	
Mar. 13	20 0		Mar. 26	20 0	
	23 0	516-9	45-1	873-0	45-1		Mar. 26	23 0	
Mar. 14	2 0	532-2	51-0	844-1	50-1		Mar. 26	2 0	518-9	45-1	873-1	45-6	
	5 0	531-7	52-3	855-2	51-6		Mar. 26	5 0	533-1	49-4	911-7	48-6	
	20 0	527-6	48-6	856-2	48-6		Mar. 27	20 0	133-25	520-1	44-1	869-0	43-5	
	23 0	130-98	518-7	52-6	841-3	52-1		Mar. 27	23 0	136-42	499-6	46-5	900-0	45-6	
Mar. 15	2 0	136-88	531-5	55-4	821-4	54-7		Mar. 28	2 0	138-55	528-4	51-1	924-7	49-2	
	5 0	131-47	532-9	56-3	836-4	55-7		Mar. 28	5 0	131-20	546-3	52-5	960-9	50-9	
	20 0	127-75	520-0	50-1	871-3	49-9		Mar. 29	20 0	129-50	519-3	44-6	900-4	45-1	
	23 0	133-90	518-0	51-1	869-2	50-6		Mar. 29	23 0	133-60	510-9	46-1	898-0	46-1	
Mar. 16	2 0	141-64	527-0	54-6	828-0	54-9		Mar. 29	2 0	139-60	526-4	50-6	889-2	49-1	
	5 0	136-12	538-6	55-6	855-9	55-2		Mar. 29	5 0	136-52	527-6	51-4	925-3	50-1	
	20 0	128-77	514-6	45-4	869-7	46-1		Mar. 30	20 0	131-13	511-0	43-7	881-0	43-5	
	23 0	133-87	514-1	48-1	893-8	47-6		Mar. 30	23 0	133-04	511-3	44-5	898-9	44-1	
Mar. 17	2 0	134-58	528-3	54-6	867-3	53-4		Mar. 30	2 0	142-80	517-9	47-2	906-5	46-1	
	5 0	132-62	528-6	52-6	879-5	52-6		Mar. 30	5 0	139-76	538-0	50-4	928-3	48-6	
	20 0	128-60	510-4	43-6	887-5	44-2		Mar. 31	20 0	127-20	519-6	44-5	905-2	44-6	
	23 0	132-27	511-4	44-6	892-6	45-1		Mar. 31	23 0	131-42	511-0	45-3	898-4	45-1	
Mar. 18	2 0	134-55	524-2	48-1	872-9	48-1		Mar. 31	2 0	134-82	530-0	49-1	888-9	47-9	
	5 0	131-43	529-4	52-3	864-3	51-8		Mar. 31	5 0	131-87	532-1	50-4	903-7	49-1	
	20 0	127-05	513-0	43-5	880-1	44-6		Mar. 31	20 0	124-39	523-4	43-4	900-6	43-3	
	23 0	134-40	510-9	44-1	891-3	45-1		Mar. 31	23 0	128-98	516-7	44-2	890-4	43-8	
Mar. 19	2 0	140-09	522-2	50-3	878-2	49-9		Apr. 1	2 0	137-32	506-2	47-4	890-6	46-1	
	5 0	140-83	535-9	51-9	926-2	51-6		Apr. 1	5 0	134-20	530-1	48-5	917-7	47-1	
Mar. 20	20 0	128-48	510-6	38-5	880-5	39-0		Apr. 1	20 0	127-61	514-8	41-5	894-5	41-5	
	23 0	132-97	511-4	42-7	892-2	43-0		Apr. 1	23 0	130-93	510-0	42-2	895-4	42-0	
Mar. 21	2 0	138-47	523-6	47-6	865-2	48-0		Apr. 2	2 0	137-20	516-9	43-2	889-7	43-0	
	5 0	133-77	531-7	52-1	840-7	51-8		Apr. 2	5 0	134-15	530-4	43-2	910-8	42-8	
	20 0	128-37	514-2	43-2	888-0	44-5		Apr. 3	20 0	127-00	513-3	39-2	911-2	39-5	
	23 0	128-67	512-9	43-7	904-0	45-1		Apr. 3	23 0	131-52	508-3	41-7	886-4	40-8	
Mar. 22	2 0	130-78	521-1	46-6	894-5	47-1		Apr. 4	2 0	136-20	529-7	48-4	895-5	46-3	
	5 0	128-32	527-4	49-1	892-7	49-4		Apr. 4	5 0	135-62	543-5	53-1	915-5	50-1	
	20 0	122-65	521-6	40-7	875-7	40-8		Apr. 5	20 0	128-38	513-6	42-2	900-2	42-5	
	23 0	129-67	518-2	42-2	890-1	42-6		Apr. 5	23 0	131-87	511-1	44-2	890-9	44-0	
Mar. 23	2 0	136-05	544-9	48-6	857-7	48-4		Apr. 5	2 0	138-40	530-0	50-4	879-8	48-5	
	5 0	131-72	541-6	55-2	832-8	53-6		Apr. 5	5 0	133-10	543-2	55-7	893-3	53-1	
	20 0	125-45	527-8	56-7	845-0	58-2		Apr. 6	20 0	128-68	509-0	43-2	873-0	43-5	
	23 0	130-13	503-8	59-4	866-9	60-5		Apr. 6	23 0	134-30	507-9	44-6	882-0	44-3	
Mar. 24	2 0	134-30	529-0	60-4	849-0	61-1		Apr. 6	2 0	139-89	530-3	51-1	890-5	49-1	
	5 0	130-50	534-0	61-9	849-7	62-9		Apr. 6	5 0	132-95	539-5	56-6	899-2	53-8	

BIFILAR. $k=0.0001248$ $q=0.000304=2.44$ Scale divisions.
 BALANCE. Jan. 23^d —Mar. 21^d 5^h $k=0.0000140$ $q=0.000073=5.20$ Micrometer divisions.
 „ March 21^d 20^h—April 16^d $k=0.0000118$ $q=0.000073=6.20$ Micrometer divisions.

March 11^d 20^h, 23^h; March 12^d 2^h, 5^h. Observations of the declination at these hours have been corrected for torsion by + 3". See note March 14^d.

March 14^d. Torsion of Declinometer thread examined. Circle moved 54°. Left reading 276°. Mr Russell conceived this torsion to have taken place on removing the magnet in order to make the Dip observation March 11^d 6^h, when most probably from the thread getting loose for a moment the fibres took a different disposition *inter se*.

March 25^d 6^h. On removing the detorsion bar from the Declinometer after the Dip observations, the suspension cylinder was accidentally let slip. Brass bar suspended throughout March 26^d, and torsion removed. Circle left reading 326°.

March 25^d 1^h—6^h. Declinometer employed in making intensity observation.

March 25^d 20^h—23^h. Observatory being cleaned.

Göttingen Mean Time of Declination Observation.			DECLINA- TION.	BIFILAR.		BALANCE.		Göttingen Mean Time of Declination Observation.			DECLINA- TION.	BIFILAR.		BALANCE.			
				Cor- rected.	Thermo- meter.	Cor- rected.	Thermo- meter.					Cor- rected.	Thermo- meter.				
d.	h.	m.	'	Sc. Div.	°	Mic. Div.	°	d.	h.	m.	'	Sc. Div.	°	Mic. Div.	°		
Apr.	6	20	0	127.67	517.3	46.6	902.0	46.8	Apr.	20	20	0	133.20	511.8	57.1	859.1	58.7
		23	0	133.77	511.0	46.9	886.7	46.6			23	0	137.70	508.8	58.6	860.8	59.5
Apr.	7	2	0	138.93	524.8	47.9	883.0	47.4	Apr.	21	2	0	140.33	526.6	63.7	845.7	63.1
		5	0	133.51	529.5	49.1	883.0	48.1			5	0	135.75	529.0	66.9	919.2	66.7
		20	0	127.80	517.2	42.7	900.8	43.0			20	0	130.52	513.3	53.6	870.7	54.1
		23	0	133.78	512.5	44.6	888.3	44.2			23	0	134.33	519.9	55.0	887.8	55.1
Apr.	8	2	0	140.47	530.6	51.1	855.8	49.1	Apr.	22	2	0	137.98	531.4	62.0	861.4	60.2
		5	0	135.65	537.0	56.1	878.5	55.2			5	0	137.58	529.2	62.6	867.0	63.1
		20	0	128.77	512.1	42.2	900.9	42.8			20	0	128.48	518.6	49.9	868.8	49.6
		23	0	132.85	507.6	43.7	882.0	43.5			23	0	130.90	511.6	50.6	884.5	50.1
Apr.	9	2	0	140.47	524.9	50.1	869.3	48.1	Apr.	23	2	0	137.80	529.5	54.6	857.7	54.4
		5	0	135.02	532.1	55.6	878.1	52.9			5	0	132.47	536.3	62.6	865.8	60.0
Apr.	10	20	0	134.44	505.9	44.6	787.7	45.3	Apr.	24	20	0	120.85	518.1	50.6	867.4	50.6
		23	0	144.32	493.4	45.6	852.2	45.6			23	0	132.20	511.3	51.3	855.6	50.9
Apr.	11	2	0	142.46	518.2	50.6	912.1	49.1	Apr.	25	2	0	137.63	529.9	57.6	855.7	56.2
		5	0	140.73	537.5	53.1	969.7	51.1			5	0	134.44	541.4	62.2	849.8	59.9
		20	0	126.43	511.9	42.2	881.9	42.1			20	0	128.01	522.0	49.1	873.7	49.1
		23	0	132.80	514.9	44.5	897.6	44.0			23	0	131.67	517.5	50.8	850.9	50.3
Apr.	12	2	0	140.55	514.6	48.0	935.5	46.6	Apr.	26	2	0	137.77	534.7	57.6	808.3	55.7
		5	0	136.33	536.1	51.0	964.0	48.6			5	0	135.02	541.9	61.6	846.6	59.2
		20	0	131.30	467.0	41.7	880.8	41.8			20	0	126.35	520.0	46.6	865.7	47.1
		23	0	149.15	477.6	42.9	863.6	42.7			23	0	131.62	513.6	49.2	861.1	48.8
Apr.	13	2	0	147.95	536.3	45.6	1041.6	44.6	Apr.	27	2	0	136.62	527.0	55.1	852.4	53.4
		5	0	139.30	530.4	47.9	932.1	46.2			5	0	135.65	540.3	59.3	841.2	56.6
		20	0	128.75	506.1	41.7	903.9	41.5			20	0	128.83	519.3	47.5	867.6	47.8
		23	0	133.13	500.7	42.7	916.6	42.5			23	0	131.69	516.8	48.6	859.6	48.4
Apr.	14	2	0	140.10	512.2	44.6	896.3	44.1	Apr.	28	2	0	137.43	530.7	54.3	829.5	52.5
		5	0	136.62	531.1	46.6	907.4	45.9			5	0	135.63	547.2	59.8	808.7	52.1
		20	0	152.33	454.9	43.7	579.6	43.5			20	0	127.54	518.9	46.3	853.7	46.9
		23	0	142.47	467.2	44.2	885.1	44.0			23	0	132.93	517.7	50.1	854.7	49.4
Apr.	15	2	0	144.34	507.4	45.6	931.4	45.1	Apr.	29	2	0	137.74	533.4	57.1	832.1	55.2
		5	0	136.92	559.8	47.1	1063.2	46.1			5	0	138.82	543.8	61.4	844.9	59.2
		20	20	146.03	499.3	42.7	862.9	43.8			20	0	130.16	518.2	48.1	874.6	48.4
		23	0	136.15	510.5	44.6	892.7	44.0			23	0	134.13	512.1	49.1	852.4	49.0
Apr.	16	2	0	141.05	512.7	47.6	933.4	46.2	Apr.	30	2	0	140.53	526.7	52.8	842.5	51.5
		5	0	137.75	533.4	52.1	932.8	49.2			5	0	138.34	535.4	55.8	858.2	54.1
Apr.	17	20	0	133.53	521.4	43.2	881.6	43.4	May	1	20	0	128.63	530.0	47.9	863.3	48.1
		23	0	134.13	503.5	44.6	892.1	44.2			23	0	134.70	520.4	50.4	844.0	49.8
Apr.	18	2	0	141.80	518.8	52.6	873.7	49.7	May	2	2	0	142.88	532.1	56.3	822.2	54.6
		5	0	133.82	535.9	59.7	924.2	56.7			5	0	137.45	538.9	60.0	840.9	58.1
		20	0	134.50	522.6	49.4	858.0	49.4			20	0	130.60	519.2	47.0	866.6	47.8
		23	0	136.68	507.9	51.3	880.8	50.6			23	30	136.82	519.6	50.5	857.3	49.9
Apr.	19	2	0	144.35	529.0	57.3	874.6	55.3	May	3	2	0	142.06	530.1	56.1	843.9	54.3
		5	0	134.38	540.4	62.6	920.3	60.2			5	0	136.93	534.2	60.0	853.7	58.2
		20	0	129.37	518.0	50.0	879.8	50.1			20	0	131.22	527.0	52.9	858.7	53.4
		23	0	136.05	512.0	52.6	865.5	51.5			23	0	133.35	514.6	53.1	845.0	53.0
Apr.	20	2	0	143.68	523.9	59.4	852.3	57.2	May	4	2	0	138.96	527.3	55.7	836.6	55.0
		5	0	137.63	546.6	64.8	894.9	61.7			5	0	135.65	537.5	58.8	841.1	57.6

BIFILAR. $k=0.0001248$ $q=0.000304=2.44$ Scale divisions.
 BALANCE. Mar. 21^d 20^h—April 16^d $k=0.0000118$ $q=0.000073=6.20$ Micrometer divisions.
 „ April 17^d — Oct. 8^d $k=0.0000130$ $q=0.000073=5.60$ Micrometer divisions.

April 15^d 20^h. Observation 20^m late, caused by error in the house clock.
 April 22^d 20^h. The previous observations were made by Mr Russell; for the following I am responsible. J. A. B.
 May 2^d 23^h. Observation 30^m late, omitted while observing Polaris.

Göttingen Mean Time of Declination Observation.			DECLINA- TION.	BIFILAR.		BALANCE.		Göttingen Mean Time of Declination Observation.			DECLINA- TION.	BIFILAR.		BALANCE.			
				Cor- rected.	Thermo- meter.	Cor- rected.	Thermo- meter.					Cor- rected.	Thermo- meter.				
d.	h.	m.	'	Sc. Div.	°	Mic. Div.	°	d.	h.	m.	'	Sc. Div.	°	Mic. Div.	°		
May	4	20	0	127-94	523-8	50-3	863-5	50-2	May	16	20	0	123-57	518-3	55-8	850-4	56-2
		23	0	134-60	512-3	50-8	851-7	50-6			23	0	128-17	539-5	57-0	863-6	56-8
May	5	2	0	140-55	524-9	52-8	833-8	52-1	May	17	2	0	134-75	525-1	59-9	894-6	58-9
		5	0	136-37	536-3	52-9	858-6	52-3			5	0	129-30	529-6	62-9	918-9	61-2
		20	0	126-46	534-2	51-1	857-6	50-9			20	0	123-87	520-1	52-9	864-1	53-0
		23	0	132-67	522-7	53-0	828-9	52-3			23	0	127-30	508-5	54-0	872-6	53-8
May	6	2	0	136-82	547-2	56-3	816-7	55-2	May	18	2	0	129-92	526-2	57-8	868-4	56-7
		5	0	140-76	546-0	57-6	850-4	56-5			5	0	128-77	537-6	61-6	865-2	60-2
		20	0	124-70	515-0	50-3	871-8	50-2			20	0	121-38	523-3	52-9	857-2	53-0
		23	0	133-17	508-2	50-7	858-1	50-6			23	0	126-08	520-1	52-9	840-8	52-8
May	7	2	0	140-87	525-2	51-6	883-7	51-1	May	19	2	0	132-67	534-2	53-7	866-2	53-3
		5	0	134-25	533-1	52-3	894-9	51-6			5	0	128-23	535-3	54-2	903-7	53-7
May	8	20	0	130-15	519-0	46-4	875-3	47-0			20	0	122-20	523-4	51-6	869-1	51-2
		23	0	133-33	510-3	47-9	863-3	48-0			23	0	126-82	525-7	54-7	831-1	53-8
May	9	2	0	137-70	531-4	50-5	853-6	49-6	May	20	2	0	129-78	533-4	58-5	835-0	57-1
		5	0	136-28	537-3	52-5	872-2	51-2			5	0	127-90	539-1	58-8	854-6	57-8
		20	0	127-23	509-9	46-0	881-2	46-6			20	0	125-28	523-4	51-0	872-5	50-9
		23	0	131-16	514-7	48-9	853-6	48-5			23	0	131-18	518-6	52-6	839-7	52-0
May	10	2	0	139-13	535-2	55-3	841-0	53-7	May	21	2	0	134-60	535-3	55-1	846-8	54-1
		5	0	133-48	541-1	58-5	883-1	56-8			5	0	130-45	546-7	56-4	864-7	55-5
		20	0	127-30	523-3	52-6	843-3	52-5	May	22	20	0	123-33	529-6	53-6	877-5	53-7
		23	0	132-33	516-9	54-3	845-5	53-8			23	0	130-05	521-4	55-0	838-8	54-6
May	11	2	0	137-58	534-5	56-7	851-7	55-9	May	23	2	0	134-33	536-7	57-1	828-5	56-1
		5	0	134-30	543-7	57-4	855-7	56-6			5	0	132-53	543-9	60-3	834-2	58-9
		20	0	127-05	519-6	50-0	848-6	50-2			20	0	123-40	526-7	52-7	867-8	52-7
		23	0	131-29	509-0	49-8	853-4	49-8			23	0	126-82	528-4	55-8	828-2	55-2
May	12	2	0	136-73	533-0	52-3	841-7	51-6	May	24	2	0	131-98	546-3	58-4	810-7	57-4
		5	3	133-13	541-9	55-8	837-0	54-4			5	0	130-18	543-7	58-2	841-9	57-5
		20	0	126-13	521-3	49-8	876-6	49-9			20	0	122-20	529-3	53-4	841-7	53-1
		23	0	131-32	518-3	52-5	854-8	51-9			23	0	128-23	527-3	55-4	840-6	54-6
May	13	2	0	137-77	530-5	58-9	816-6	57-1	May	25	2	0	133-47	543-6	58-7	822-8	57-4
		5	0	134-57	550-4	62-7	821-1	60-7			5	0	130-18	551-7	61-1	828-5	59-7
		20	0	125-55	525-5	54-6	856-9	54-9			20	0	122-73	531-7	52-9	842-4	52-9
		23	0	130-67	526-0	57-2	846-2	56-7			23	0	129-52	522-3	55-4	838-1	54-8
May	14	2	0	May	26	2	0	135-22	535-3	59-7	813-3	58-2
		5	0	133-64	545-2	65-5	826-7	63-7			5	0	130-12	537-2	60-5	842-7	59-3
May	15	20	0	126-05	526-7	54-5	849-4	55-1			20	0	122-87	530-3	53-7	847-7	53-6
		23	0	131-38	522-4	56-9	820-0	56-5			23	0	130-12	516-7	54-9	832-5	54-5
May	16	2	0	140-49	517-2	62-7	898-9	61-1	May	27	2	0	134-13	534-1	58-4	833-1	57-2
		5	0	149-71	574-3	67-0	998-4	64-7			5	0	129-98	543-3	61-4	840-5	59-9

BIFILAR. $k=0.0001248$ $q=0.000304=2.44$ Scale divisions.
 BALANCE. April 17^d—Oct. 8^d $k=0.0000130$ $q=0.000073=5.30$ Micrometer divisions.

May 12^d 5^h. Observation 3^m late.
 May 16^d 5^h. Extra observations.
 The observations of Declination at the following times are corrected for torsion by the quantities annexed to them. (See note, May 30^d.) May 16^d 23^h till May 23^d 5^h—10'.93. May 23^d 20^h till May 30^d 20^h—13'.08. May 30^d 23^h—8'.39. May 31^d 2^h—2'.15. May 31^d 5^h till June 2^d 5^h—1'.95. June 2^d 20^h till June 3^d 5^h+6'.47.
 May 23^d 22^h. A fibre of the Declinometer suspension thread was found broken; it was removed by cutting near the top and bottom ties.
 May 24^d 8^h. Extra observations.
 May 25^d 3^h. Extra observations during thunder-storm.

Göttingen Mean Time of Declination Observation.			DECLINA- TION.	BIFILAR.		BALANCE.		Göttingen Mean Time of Declination Observation.			DECLINA- TION.	BIFILAR.		BALANCE.			
				Cor- rected.	Thermo- meter.	Cor- rected.	Thermo- meter.					Cor- rected.	Thermo- meter.				
d.	h.	m.		Sc. Div.	°	Mic. Div.	°	d.	h.	m.		Sc. Div.	°	Mic. Div.	°		
May	27	20	0	126.62	528.3	54.8	848.4	56.2	June	9	20	0	125.95	523.8	57.9	846.1	58.1
		23	0	130.45	523.8	58.1	815.0	57.8			23	0	130.53	526.2	60.3	811.8	59.9
May	28	2	0	136.15	539.2	61.3	793.8	60.5	June	10	2	0	140.63	553.1	63.1	761.8	62.2
		5	0	131.92	543.3	63.0	811.5	62.3			5	0	138.01	544.7	64.0	786.4	63.7
May	29	20	0	125.88	529.2	55.8	846.1	55.6			20	0	125.23	529.4	58.5	827.6	58.6
		23	0	129.30	527.7	57.4	824.7	56.9			23	0	129.49	518.8	60.4	813.0	59.8
May	30	2	0	130.32	544.3	60.4	800.4	59.4	June	11	2	0	136.60	538.5	64.5	801.6	63.1
		5	0	128.43	545.1	61.4	819.9	60.3			5	0	135.45	551.5	69.3	802.5	66.9
		20	0	123.13	529.4	55.4	841.0	55.3	June	12	20	0	127.54	533.6	58.6	785.0	58.8
		23	0	125.68	522.7	57.1	808.8	56.6			23	0	130.05	524.6	60.9	820.2	60.4
May	31	2	0	130.52	542.1	61.0	793.8	59.8	June	13	2	0	139.20	538.6	68.0	795.1	66.0
		5	0	129.52	547.9	64.1	814.7	62.6			5	0	139.12	556.4	73.8	828.2	70.9
		20	0	123.60	531.7	54.2	827.1	54.4			20	0	132.37	522.1	65.2	772.9	65.5
		23	0	127.77	530.4	55.9	826.4	55.7	June	14	23	0	131.05	509.2	66.0	806.7	65.8
June	1	2	0	132.93	540.3	57.5	788.6	56.8	June	14	2	0	139.45	532.6	69.9	827.1	68.6
		5	0	129.78	549.5	58.5	826.4	57.9			5	0	138.49	563.9	72.3	848.1	70.9
		20	0	125.15	532.9	54.1	821.8	54.3			20	0	129.52	525.5	61.7	792.8	61.9
		23	0	127.77	531.5	55.4	791.5	55.1	June	15	23	0	129.65	520.2	62.5	807.3	62.3
June	2	2	0	135.48	549.0	59.0	796.6	58.2	June	15	2	0	133.35	537.2	64.5	812.6	63.9
		5	0	132.53	547.5	62.4	832.6	60.9			5	0	134.05	550.3	68.7	803.0	67.1
		20	0	119.92	529.2	54.8	854.6	55.2			20	0	125.53	525.0	61.9	825.1	61.9
		23	0	125.08	531.8	56.9	840.4	56.5	June	16	23	0	130.42	526.8	63.6	827.9	63.1
June	3	2	0	130.25	535.8	63.6	804.0	61.9	June	16	2	0	134.93	534.8	64.6	813.6	63.7
		5	0	131.92	554.9	68.5	824.4	66.2			5	0	133.13	542.9	64.7	831.8	64.1
		20	0	123.93	526.8	60.4	834.1	60.5			20	0	124.97	526.1	55.7	843.1	55.7
		23	0	129.56	533.6	63.0	797.2	62.4	June	17	23	0	133.73	520.1	56.9	825.1	56.6
June	4	2	0	134.44	549.4	68.4	772.5	66.7	June	17	2	0	136.88	540.3	59.2	807.5	58.3
		5	0	139.55	553.8	70.5	771.9	68.9			5	0	133.91	540.5	61.3	827.0	60.2
June	5	20	0	123.33	522.3	59.2	834.7	59.2			20	0	126.52	528.5	53.5	835.3	53.5
		23	0	130.92	516.1	61.3	819.4	60.6	June	18	23	0	130.29	528.4	56.3	824.3	55.7
June	6	2	0	133.27	536.9	65.3	811.0	64.0	June	18	2	0	134.38	538.3	59.9	797.5	58.5
		5	0	128.81	543.1	67.6	829.6	66.3			5	0	133.80	547.8	62.1	805.9	60.9
		20	0	517.5	58.9	808.9	59.2	June	19	20	0	127.18	530.3	55.0	849.5	55.0
		23	0	130.82	513.5	60.4	835.7	60.1	June	19	23	0	129.73	529.5	55.9	839.4	55.5
June	7	2	0	137.68	531.2	65.5	813.2	64.0	June	20	2	0	134.33	542.0	58.7	830.5	57.6
		5	0	129.62	548.8	69.7	813.8	67.8			5	0	132.97	559.8	63.0	819.7	61.3
		20	0	126.48	819.3	60.7			20	0	126.15	527.8	58.8	831.3	58.9
		23	0	127.00	526.2	63.4	830.0	62.9	June	21	23	0	128.10	524.4	61.0	824.0	60.4
June	8	2	0	134.83	535.4	68.1	815.9	66.8	June	21	2	0	134.15	536.3	65.0	784.8	63.7
		5	0	132.44	551.9	70.7	804.4	69.1			5	0	130.18	544.5	68.3	796.3	66.5
		20	0	123.00	521.5	59.4	817.4	59.9			20	0	123.73	537.6	59.8	826.8	60.2
		23	0	128.65	523.0	60.4	808.6	60.4	June	22	23	0	130.05	523.6	60.9	804.6	60.7
June	9	2	0	138.05	526.4	64.3	812.1	63.3	June	22	2	0	135.35	538.8	64.0	785.8	63.1
		5	0	136.99	545.8	66.5	834.2	65.3			5	0	131.55	553.5	66.9	796.0	65.4

BIFILAR. $k=0.0001248$ $q=0.000304=2.44$ Scale divisions.

BALANCE. April 17^h—Oct. 8^d $k=0.0900130$ $q=0.000073=5.60$ Micrometer divisions.

DECLINATION. Torsion removed. Circle reading. June 3^d 6^h, 215°. June 6^d 20^h, 329°. (See note below.) June 18^d 6^h, 336°. June 20^d 21^h, 40°.

May 30^d 20^h. The Declinometer magnet having been removed, and the brass bar inserted, in order to make the Dip observation, the brass bar was allowed to move freely, to find if any torsion existed, when it went round about 400°. See Introduction for remarks on this torsion, and the correction of observations.

June 6^d 20^h. Found two fibres of the Declinometer suspension thread broken, which had induced a considerable quantity of torsion. The fibres were cut off, and the torsion eliminated.

June 18^d 6^h; 21^d 8^h; 26^d 23^h. Observations made to determine the value $\frac{H}{T}$ for Declinometer thread.

Göttingen Mean Time of Declination Observation.			DECLINA- TION.	BIFILAR.		BALANCE.		Göttingen Mean Time of Declination Observation.			DECLINA- TION.	BIFILAR.		BALANCE.	
				Cor- rected.	Thermo- meter.	Cor- rected.	Thermo- meter.					Cor- rected.	Thermo- meter.		
d.	h.	m.	'	Se. Div.	°	Mic. Div.	°	d.	h.	m.	'	Se. Div.	°	Mic. Div.	°
June 22	20	0	123.02	517.3	58.6	781.6	59.2	July 5	20	0	128.90	517.8	54.8	795.4	55.1
	23	0	127.81	528.4	60.9	792.1	60.7		23	0	126.33	529.8	57.3	824.9	56.6
June 23	2	0	133.02	548.4	64.7	796.0	65.0	July 6	2	0	134.13	538.1	60.4	808.1	59.3
	5	0	129.73	549.2	67.5	806.5	66.4		5	0	131.38	542.6	63.7	805.5	62.1
	20	0	124.04	515.3	59.9	823.8	60.1		20	0	125.79	524.1	54.2	828.5	54.6
	23	0	126.43	509.3	60.9	831.9	60.7		23	0	126.25	520.6	55.4	825.9	55.3
June 24	2	0	134.30	529.6	63.4	846.2	62.7	July 7	2	0	133.05	527.5	57.9	824.9	57.1
	5	0	131.70	545.8	65.2	827.6	64.2		5	0	131.62	540.8	58.6	831.7	57.9
	20	0	122.27	529.0	58.2	818.1	58.3		20	0	124.88	526.0	54.3	845.5	54.3
	23	0	129.23	517.6	59.1	836.7	58.0		23	0	126.35	520.1	56.2	801.6	55.7
June 25	2	0	129.18	542.1	60.4	812.9	60.0	July 8	2	0	134.33	531.4	59.9	816.2	58.8
	5	0	131.10	545.3	60.4	818.6	60.1		5	0	132.95	543.1	61.4	815.5	60.2
June 26	20	0	123.30	528.8	58.2	820.6	57.7		20	0	130.15	532.0	56.4	697.8	56.4
	23	0	127.63	526.6	59.9	806.4	59.2		23	0	130.05	525.7	59.1	795.3	58.3
June 27	2	0	134.79	543.0	63.1	790.5	61.9	July 9	2	0	135.92	535.6	62.7	829.7	61.4
	5	0	132.48	549.8	65.7	798.6	64.2		5	0	134.33	565.6	65.1	861.7	63.7
	20	0	124.13	531.4	56.4	833.5	56.7	July 10	20	0	127.54	520.8	56.3	828.4	56.3
	23	0	126.94	521.7	57.3	806.7	57.1		23	0	129.78	505.5	56.5	829.2	56.4
June 28	2	0	133.93	532.8	59.9	799.5	59.2	July 11	2	0	136.57	531.9	59.3	827.6	58.5
	5	0	132.73	550.7	62.5	815.9	61.2		5	0	131.32	545.2	62.4	834.4	61.2
	20	0	124.42	537.7	58.4	821.1	58.3		20	0	124.04	532.3	59.0	828.6	59.1
	23	0	128.74	530.7	59.5	812.8	59.2		23	0	126.90	524.2	60.6	818.1	60.1
June 29	2	0	133.05	546.7	61.4	791.7	60.5	July 12	2	0	135.53	541.0	64.6	804.7	63.3
	5	0	132.78	550.4	63.1	787.7	62.2		5	0	131.83	553.6	66.8	815.5	65.3
	20	0	121.98	534.8	57.9	807.8	56.9		20	0	123.80	534.7	60.3	820.2	60.2
	23	0	128.85	527.3	59.6	790.0	59.1		23	0	126.48	523.4	62.5	829.1	61.6
June 30	2	0	133.48	540.1	61.2	772.6	62.7	July 13	2	0	131.78	535.6	65.1	790.8	64.0
	5	0	133.27	546.4	66.4	785.0	65.1		5	0	131.60	545.4	66.3	810.6	65.3
	20	0	123.75	528.1	59.8	786.1	59.9		20	0	122.45	526.4	58.3	833.5	58.5
	23	0	131.96	523.5	62.5	790.8	61.8	July 14	23	0	129.41	521.0	59.3	830.4	59.2
July 1	2	0	136.52	543.0	66.1	757.7	65.0		2	0	131.00	528.3	61.4	805.5	60.6
	5	0	133.50	549.8	68.4	805.7	66.9		5	5	129.80	539.6	63.5	813.4	62.3
	20	0	126.39	479.9	58.4	618.5	58.7		20	0	125.23	535.5	56.8	818.1	56.7
	23	0	130.65	502.1	58.4	731.7	58.5	July 15	23	0	128.83	530.6	59.1	796.5	58.4
July 2	2	0	138.01	542.4	60.0	809.6	59.9		2	0	133.24	540.4	64.4	788.0	62.8
	5	0	137.41	559.0	61.6	799.2	61.2		5	0	130.72	551.1	68.7	789.2	66.7
July 3	20	0	132.20	443.6	56.4	522.6	56.4		20	0	122.65	524.8	60.2	801.6	60.4
	23	0	133.27	502.6	58.2	742.1	57.9	July 16	23	0	128.20	527.2	63.3	786.3	62.5
July 4	2	0	123.90	625.6	60.5	1062.8	59.9		2	0	133.00	545.2	68.6	780.0	67.1
	5	0	129.49	573.9	62.5	959.3	61.7		5	0	129.49	548.0	71.6	795.2	69.7
	20	0	123.20	512.2	59.0	831.0	59.2	July 17	20	0	122.80	532.8	59.9	825.2	59.9
	23	0	135.65	501.6	61.1	848.9	60.5		23	0	128.77	525.0	61.7	805.0	61.1
July 5	2	0	134.86	531.5	62.6	812.6	61.9	July 18	2	0	135.08	536.5	63.9	784.7	62.9
	5	0	132.27	530.4	63.4	826.4	62.7		5	0	131.78	542.3	65.8	796.7	64.5

BIFILAR. $k=0.0001248$ $q=0.000304=2.44$ Scale divisions.

BALANCE. April 17^d—Oct. 8^d $k=0.0000130$ $q=0.000073=5.60$ Micrometer divisions.

DECLINATION. Torsion removed. Circle reading 40°. June 24^d 7^h, 57°. June 26^d 20^h, 230°. (See note below.) June 27^d 20^h, 235°. July 1^d 7^h, 312°. July 4^d 20^h, 312°. July 8^d 8^h, 342°. July 15^d 8^h, 4°.

June 26^d 20^h. A fibre of the Declinometer suspension thread found broken; removed after the observation: when the torsion was tried, its effect was found equivalent to + 7.79. The reading at 20^h was therefore corrected by — 7.79.

July 1^d—4^d. Extra observations.

July 9^d 5^h. Extra observations.

July 14^d 5^h. Observation 5^m late. Instruments quite stationary.

Göttingen Mean Time of Declination Observation.			DECLINA- TION.	BIFILAR.		BALANCE.		Göttingen Mean Time of Declination Observation.			DECLINA- TION.	BIFILAR.		BALANCE.	
				Cor- rected.	Thermo- meter.	Cor- rected.	Thermo- meter.					Cor- rected.	Thermo- meter.		
d.	h.	m.	'	Sc. Div.	°	Mic. Div.	°	d.	h.	m.	'	Sc. Div.	°	Mic. Div.	°
July 18	20	0	125.88	537.2	59.5	772.9	59.5	July 31	20	0	124.27	519.1	60.9	714.0	61.3
	23	0	129.05	534.0	59.8	792.2	59.6		23	0	129.69	519.9	63.4	789.6	62.8
July 19	2	0	134.75	530.2	61.3	800.0	60.5	Aug. 1	2	0	130.72	555.0	69.5	798.1	67.7
	5	0	132.82	544.4	62.7	808.4	61.7		5	0	134.75	564.6	74.3	772.2	72.0
	20	0	132.40	523.2	56.8	794.7	56.6		20	0	124.72	527.5	62.5	784.0	62.9
	23	0	130.30	521.4	57.1	806.6	56.8		23	30	127.80	531.7	65.7	758.1	65.2
July 20	2	0	132.27	540.3	58.5	798.9	57.9	Aug. 2	2	0	135.20	541.5	67.7	756.3	66.7
	5	0	132.30	547.3	58.8	816.3	58.3		5	0	130.90	543.8	70.7	763.0	69.2
	20	0	120.93	530.8	59.1	803.5	59.2		20	0	126.00	528.4	58.8	799.4	59.4
	23	0	125.22	526.9	60.6	786.5	60.1		23	0	127.98	531.0	61.8	778.3	61.3
July 21	2	0	132.38	538.9	63.2	794.1	62.3	Aug. 3	2	0	133.38	541.6	68.0	758.8	66.5
	5	0	130.52	543.8	62.7	798.5	63.1		5	0	128.47	545.5	70.6	761.2	69.0
	20	0	121.15	527.3	55.4	822.0	55.4		20	0	125.62	530.0	61.3	788.2	61.7
	23	0	125.55	527.4	56.3	819.9	56.1		23	0	128.30	518.5	61.2	780.0	61.5
July 22	2	0	133.67	548.1	59.1	794.8	58.2	Aug. 4	2	0	132.65	539.7	63.5	774.7	62.9
	5	0	132.84	558.7	62.5	807.9	60.7		5	0	129.49	557.9	65.6	773.0	64.7
	20	0	131.75	521.0	52.9	779.3	53.1		20	0	128.40	531.3	62.3	729.3	62.0
	23	0	128.88	524.7	55.3	800.7	54.9		23	0	138.92	517.3	64.7	766.7	63.8
July 23	2	0	136.45	542.4	62.6	801.6	60.6	Aug. 5	2	0	136.95	548.4	67.0	760.2	65.8
	5	0	130.73	571.7	70.4	825.9	67.3		5	0	131.65	548.0	67.4	793.0	66.5
July 24	20	0	123.05	528.9	62.3	783.9	62.4		20	0	131.78	506.9	56.9	714.8	57.3
	23	0	128.87	519.1	63.9	786.8	63.3		23	0	125.82	494.9	58.8	792.4	58.6
July 25	2	0	135.22	538.3	64.9	782.5	65.0	Aug. 6	2	0	134.82	529.2	62.6	794.2	61.6
	5	0	130.83	545.3	68.2	788.7	66.8		5	0	124.07	531.6	65.6	880.9	64.1
	20	0	122.87	529.2	60.4	798.2	60.4	Aug. 7	20	0	123.13	532.1	57.9	774.6	58.1
	23	0	130.09	523.3	63.1	780.6	62.3		23	0	129.08	519.5	59.8	787.7	59.3
July 26	2	0	134.83	544.1	66.2	761.0	65.0	Aug. 8	2	0	132.51	540.0	64.0	786.7	62.7
	5	0	130.83	548.8	68.1	783.9	66.6		5	0	129.49	548.6	65.4	791.2	64.1
	20	0	121.38	528.9	60.4	794.8	60.5		20	0	124.59	533.3	62.8	770.2	62.7
	23	0	126.54	527.9	62.9	780.9	62.3		23	0	126.98	530.0	64.9	755.3	64.1
July 27	2	0	136.95	542.9	65.9	773.5	64.9	Aug. 9	2	0	133.05	533.2	67.9	765.3	66.7
	5	0	132.91	553.8	67.4	793.2	66.3		5	0	130.18	547.1	69.9	762.0	68.5
	20	0	123.00	530.4	58.6	798.7	59.1		20	0	124.62	537.2	63.8	779.6	63.8
	23	0	127.23	525.6	59.5	798.8	59.5		23	0	127.47	526.8	66.8	769.0	66.2
July 28	2	0	135.03	544.8	60.9	776.1	60.6	Aug. 10	2	0	132.55	542.3	72.1	746.6	70.6
	5	0	131.90	551.2	63.8	802.1	62.7		5	0	128.97	551.4	73.2	754.6	71.9
	20	0	122.70	524.6	56.9	812.4	57.1		20	0	123.82	526.8	63.9	753.9	64.2
	23	0	126.80	520.2	57.7	791.1	57.6		23	0	126.32	525.3	62.8	770.1	63.3
July 29	2	0	134.48	555.1	59.8	753.3	59.2	Aug. 11	2	0	132.80	537.6	64.6	790.4	64.5
	5	0	134.07	547.7	61.5	800.5	60.7		5	0	129.92	556.5	65.5	784.8	65.2
	20	0	123.87	524.5	54.5	797.4	54.9		20	0	123.07	530.3	60.7	771.1	60.7
	23	0	127.87	521.6	57.4	793.2	56.7		23	0	137.12	518.2	62.8	772.5	62.2
July 30	2	0	133.13	540.5	61.7	770.2	60.4	Aug. 12	2	0	134.20	537.4	65.6	764.7	64.5
	5	0	132.31	554.2	64.4	801.7	63.0		5	0	129.82	542.7	66.9	784.8	65.9

BIFILAR. $k=0.0001248$ $g=0.000304=2.44$ Scale divisions.

BALANCE. April 17^h - Oct. 8^d $k=0.0000130$ $g=0.000073=5.60$ Micrometer divisions.

DECLINATION. Torsion removed. Circle reading 4°. July 19^d 20^h, 61°. (See note below.) July 20^d 6^h, 80°. July 22^d 7^h, 101°. July 25^d 21^h, 108°. July 29^d 6^h, 118°. Aug. 1^d 21^h, 110°. Aug. 5^d 6^h, 124°. Aug. 8^d 21^h, 118°.

July 18^d 20^h. A fibre of Declination suspension thread found broken. Torsion removed. Observation at 20^h corrected for torsion by 3'.35.

July 19^d 5^h. A thread prepared on May 26, and having a brass weight suspended by it since, was now inserted. This thread is composed of 20 fibres, instead of 16, as formerly. The torsion was completely removed. Brass bar left in during the night.

July 19^d 20^h. Observation of Declination 43^m too late, delayed during the elimination of torsion.

July 20^d 5^h. The Bifilar reading is 55^m too late; omitted accidentally.

July 22^d 20^h; 29^d 5^h; 31^d 20^h; Aug. 4^d. Extra observations.

Aug. 1^d 23^h. Observation 30^m late.

Göttingen Mean Time of Declination Observation.			DECLINA- TION.	BIFILAR.		BALANCE.		Göttingen Mean Time of Declination Observation.			DECLINA- TION.	BIFILAR.		BALANCE.	
				Cor- rected.	Thermo- meter.	Cor- rected.	Thermo- meter.					Cor- rected.	Thermo- meter.		
d.	h.	m.	'	Sc. Div.	°	Mic. Div.	°	d.	h.	m.	'	Sc. Div.	°	Mic. Div.	°
Aug. 12	20	0	125-17	536.3	64.5	769.3	64.2	Aug. 25	20	0	121-55	530.6	57.9	801.9	57.8
	23	0	128-83	531.5	66.1	754.8	65.4		23	0	127-75	529.3	59.4	777.2	58.9
Aug. 13	2	0	132-33	537.4	69.0	748.9	67.8	Aug. 26	2	0	133-60	546.2	61.5	768.4	60.6
	5	0	126-87	541.7	68.6	775.6	67.8		5	0	128-54	552.7	63.8	783.9	62.5
Aug. 14	20	0	123-64	530.8	61.9	794.1	62.2		20	0	123-00	533.8	60.5	759.1	60.7
	23	0	127-94	530.0	64.1	769.8	62.7		23	0	124-85	525.8	60.8	759.7	60.9
Aug. 15	2	0	131-82	540.5	70.7	749.0	69.3	Aug. 27	2	0	131-45	542.7	64.4	751.8	63.9
	5	0	126-85	547.3	73.7	778.7	72.2		5	0	127-43	556.9	66.7	753.7	65.8
	20	0	123-22	528.8	62.5	782.1	62.7	Aug. 28	20	0	120-38	531.9	60.0	794.8	60.0
	23	0	128-40	526.4	63.6	772.0	63.3		23	0	127-97	523.7	61.4	781.7	61.1
Aug. 16	2	0	132-51	540.3	65.5	763.4	64.7	Aug. 29	2	0	133-55	544.4	66.4	750.9	65.2
	5	0	127-78	546.6	66.9	769.3	66.0		5	0	127-57	549.3	71.6	746.5	69.8
	20	0	120-15	532.2	61.3	758.2	61.2		20	0	122-85	529.8	62.9	775.9	63.2
	23	0	130-63	535.6	62.8	733.3	62.3	Aug. 30	0	0	130-98	530.9	63.6	744.9	63.6
Aug. 17	2	0	136-95	552.3	67.7	740.1	66.2		2	0	132-64	539.8	64.5	759.2	64.1
	5	0	130-22	558.4	74.1	730.1	71.9		5	0	126-25	540.5	64.1	781.1	64.0
	20	0	126-22	528.5	66.4	711.8	66.6		20	0	123-50	526.4	52.8	790.1	53.5
	23	0	133-77	518.0	68.7	738.6	68.1		23	0	127-72	524.3	54.6	790.8	54.5
Aug. 18	2	0	134-07	541.9	75.1	720.6	73.6	Aug. 31	2	0	131-05	540.7	59.9	759.0	58.7
	5	0	127-85	558.3	79.0	807.2	77.1		5	0	127-00	548.0	63.7	767.4	62.0
	20	0	127-83	516.0	69.6	755.0	69.8		20	0	121-84	533.9	56.0	788.7	56.2
	23	0	132-53	523.3	70.4	715.6	70.2		23	0	127-61	527.1	56.9	765.8	56.7
Aug. 19	2	0	129-30	567.9	71.4	764.4	70.9	Sept. 1	2	0	131-78	544.4	60.5	758.3	59.5
	5	0	125-05	595.2	72.0	1123.6	71.6		5	0	124-52	551.2	63.5	771.1	62.2
	20	0	124-20	519.8	64.9	799.8	65.2		20	0	123-87	542.4	64.0	748.3	63.4
	23	0	135-62	518.4	65.4	774.7	65.4		23	0	131-72	523.8	64.9	760.2	64.2
Aug. 20	2	0	135-59	536.4	65.2	775.2	65.3	Sept. 2	2	0	132-42	538.8	65.7	766.9	65.2
	5	0	128-57	538.8	64.9	799.3	64.9		5	0	130-96	542.5	66.2	849.2	65.7
Aug. 21	20	0	123-84	519.4	56.7	802.5	57.2		20	0	125-65	533.9	63.4	747.2	63.3
	23	0	130-22	519.3	57.7	794.8	57.8		23	0	129-89	520.3	63.9	761.4	63.7
Aug. 22	2	0	137-18	545.0	62.7	779.8	61.4	Sept. 3	2	0	133-67	536.2	65.0	781.5	64.6
	5	0	129-60	552.5	66.7	790.5	65.0		5	0	125-60	539.4	64.9	790.8	64.6
	20	0	123-04	527.2	59.4	786.0	59.6	Sept. 4	20	0	125-22	517.4	54.4	770.1	54.8
	23	0	133-20	521.7	61.9	781.7	61.5		23	0	130-60	530.6	55.6	775.6	55.6
Aug. 23	2	0	132-50	547.5	68.3	756.8	66.6	Sept. 5	2	0	134-20	539.2	58.4	776.1	57.5
	5	0	130-18	542.6	72.2	756.0	70.4		5	0	129-25	553.4	59.8	803.2	58.9
	20	0	122-91	534.7	64.6	773.3	64.9		20	0	125-50	532.5	57.6	772.7	57.7
	23	0	128-74	529.1	63.6	762.3	63.8		23	0	132-37	519.8	58.7	768.4	58.4
Aug. 24	2	0	137-68	540.4	63.4	772.1	63.5	Sept. 6	2	0	133-10	543.3	61.3	768.3	60.6
	5	0	131-80	538.5	63.5	845.8	63.5		5	0	127-85	546.4	62.5	795.2	61.7
	20	0	123-84	522.3	53.6	798.2	53.2		20	0	124-82	524.1	52.6	793.6	53.1
	23	0	130-09	520.9	54.8	799.4	54.6		23	0	130-32	519.7	54.3	794.2	54.2
Aug. 25	2	0	134-28	544.4	60.4	785.1	59.1	Sept. 7	2	0	134-18	543.9	58.3	768.6	57.2
	5	0	128-27	548.9	63.6	804.7	61.8		5	0	127-85	546.3	62.4	782.8	60.7

BIFILAR. $k=0.0001248$ $q=0.000304=2.44$ Scale divisions.

BALANCE. April 17^d—Oct. 8^d $k=0.0000130$ $q=0.000073=5.60$ Micrometer divisions.

DECLINATION. Torsion removed. Circle reading 118°. Aug. 15^d 21^h, 123°. Aug. 22^d 21^h, 135°. Aug. 29^d 21^h, 147°. Sept. 5^d 21^h, 147°.

Aug. 16^d 20^h; 19^d 5^h; 24^d 5^h; Sept. 2^d 5^h—9^h; Sept. 5^d 6^h. Extra observations.

Aug. 22^d 7^h. Observation to determine the value of $\frac{H}{F}$ for the Declinometer thread.

Aug. 26^d. Wind vane put up in Observatory.

Aug. 30^d 0^h. Observation 1^h late, by mistake.

16 DAILY OBSERVATIONS OF MAGNETOMETERS, SEPTEMBER 7—OCTOBER 5. 1842.

Göttingen Mean Time of Declination Observation.			DECLINA- TION.	BIFILAR.		BALANCE.		Göttingen Mean Time of Declination Observation.			DECLINA- TION.	BIFILAR.		BALANCE.	
				Cor- rected.	Thermo- meter.	Cor- rected.	Thermo- meter.					Cor- rected.	Thermo- meter.		
d.	h.	m.	'	Sc. Div.	°	Mic. Div.	°	d.	h.	m.	'	°	Sc. Div.	Mic. Div.	°
Sept. 7	20	0	125.33	535.4	57.2	775.1	57.3	Sept. 21	20	0	130.16	534.3	59.9	773.1	61.1
	23	0	129.32	523.4	57.8	777.5	57.7		23	0	136.30	528.3	60.6	769.4	61.7
Sept. 8	2	0	134.08	536.6	58.9	773.4	58.7	Sept. 22	2	0	140.23	548.5	62.5	750.8	62.5
	5	0	128.28	550.9	60.5	793.7	59.9		5	0	134.42	544.5	61.4	786.6	62.7
	20	0	124.27	529.2	55.4	793.6	55.6		20	0	132.30	538.2	56.0	757.3	56.4
	23	0	129.37	518.2	55.8	786.7	55.8		23	0	136.37	525.1	57.4	794.4	57.2
Sept. 9	2	0	135.48	534.8	59.0	769.4	58.2	Sept. 23	2	0	133.13	539.2	58.6	785.3	58.2
	5	0	127.00	557.8	62.1	833.6	60.7		5	0	127.83	540.8	58.9	811.5	58.5
	20	0	125.46	529.8	55.5	792.3	55.7		20	0	124.59	535.8	54.2	778.2	54.3
	23	0	130.43	525.5	56.5	790.1	56.4		23	0	127.14	526.8	53.8	784.0	53.9
Sept. 10	2	0	134.33	541.5	59.4	781.1	58.7	Sept. 24	2	0	131.80	537.8	54.1	775.5	54.0
	5	0	129.69	542.6	61.3	779.5	60.3		5	0	128.81	544.3	59.4	804.6	59.2
Sept. 11	20	0	125.62	531.2	55.5	755.7	55.6	Sept. 25	20	0	122.20	531.1	52.0	791.4	51.8
	23	0	127.63	526.0	56.2	777.8	56.1		23	0	125.32	526.5	54.2	785.8	54.0
Sept. 12	2	0	135.08	532.9	58.8	773.8	58.1	Sept. 26	2	0	130.22	541.3	58.8	766.3	58.8
	5	0	127.83	545.3	61.8	775.0	60.3		5	0	127.68	549.0	61.7	766.1	62.2
	20	0	122.70	519.2	53.9	785.4	54.1		20	0	123.80	533.4	52.3	784.6	52.6
	23	0	133.24	508.8	54.8	802.7	54.8		23	0	126.52	522.6	52.6	783.1	52.8
Sept. 13	2	0	138.95	548.9	57.7	785.5	56.7	Sept. 27	2	0	134.00	538.4	55.3	762.4	54.6
	5	0	127.17	542.9	60.8	800.1	59.4		5	0	128.97	548.0	57.6	788.2	57.5
	20	0	125.03	535.6	59.2	746.4	59.1		20	0	123.95	536.5	50.5	795.5	50.5
	23	0	130.78	527.5	60.4	762.5	59.9		23	0	126.43	526.1	50.4	778.6	50.2
Sept. 14	2	0	133.60	541.2	63.4	763.7	62.3	Sept. 28	2	0	132.13	541.6	57.5	767.9	57.8
	5	0	129.56	550.6	65.4	766.0	64.2		5	0	128.65	547.3	58.9	771.1	59.3
	20	0	126.68	530.1	60.6	762.6	60.7		20	0	122.82	539.0	50.0	754.8	50.2
	23	0	131.49	529.4	60.6	758.6	60.7		23	0	135.65	503.7	50.9	786.6	51.0
Sept. 15	2	0	134.47	540.4	63.6	757.7	62.8	Sept. 29	2	0	133.51	536.6	53.5	816.9	53.0
	5	0	127.20	538.6	65.0	781.5	64.2		5	0	128.23	544.6	59.9	849.7	59.3
	20	0	133.98	528.7	59.6	758.7	59.7		20	0	127.63	524.5	47.5	779.7	48.2
	23	0	134.30	530.8	60.8	768.3	60.6		23	0	126.25	531.2	48.8	791.3	48.0
Sept. 16	2	0	136.22	536.8	63.9	789.6	63.0	Sept. 30	2	0	131.45	531.7	53.8	785.2	52.6
	5	0	128.97	542.2	65.8	791.0	64.7		5	0	130.50	528.1	55.8	813.6	54.4
	20	0	131.32	536.7	59.4	708.8	59.7		20	0	126.43	531.8	46.7	778.5	47.3
	23	0	136.50	528.3	60.7	753.0	60.5		23	0	129.17	523.7	47.5	795.4	47.6
Sept. 17	2	0	133.62	542.4	62.3	780.5	61.7	Oct. 1	2	0	130.80	535.9	51.0	775.2	50.1
	5	0	129.37	541.5	62.5	799.1	62.2		5	0	129.01	538.7	53.5	776.6	52.3
Sept. 18	20	0	130.45	528.5	53.4	773.6	53.6	Oct. 2	20	0	126.94	536.2	51.7	761.3	51.7
	23	0	132.27	526.2	53.8	789.7	53.8		23	0	127.90	528.0	51.8	772.3	51.7
Sept. 19	2	0	133.73	542.8	55.9	778.2	55.4	Oct. 3	2	0	132.25	538.0	52.6	769.2	52.1
	5	0	127.70	542.9	60.1	790.0	58.4		5	0	130.25	536.1	53.0	775.8	52.3
	20	0	124.62	529.2	54.0	776.1	54.1		20	0	124.93	536.1	43.5	772.7	44.3
	23	0	135.45	524.1	54.8	764.7	54.7		23	0	128.40	520.1	43.5	792.4	44.0
Sept. 20	2	0	137.83	550.2	58.5	756.7	57.5	Oct. 4	2	0	133.77	539.8	48.6	777.7	47.6
	5	0	135.52	545.5	62.4	791.5	60.4		5	0	129.78	546.6	52.9	784.7	51.0
	20	0	135.42	525.5	50.4	756.7	50.8		20	0	125.82	535.3	45.9	779.8	46.1
	23	0	133.13	521.9	52.3	777.2	52.6		23	0	127.58	526.6	47.5	783.1	47.1
Sept. 21	2	0	137.30	539.0	58.6	768.6	58.1	Oct. 5	2	0	132.27	540.7	51.9	766.4	50.6
	5	0	130.75	544.3	61.4	808.2	60.4		5	0	132.77	547.7	53.9	777.6	52.5

BIFILAR. $k=0.0001218$ $q=0.000304=2.44$ Scale divisions.
 BALANCE. April 17^d. Oct. 8^d $k=0.0000130$ $q=0.000073=5.60$ Micrometer divisions.
 DECLINATION. Torsion removed. Circle reading 147°. Sept. 9^d 6^h, 147°. Sept. 12^d 21^h, 127°. Sept. 16^d 20^h, 137°. Sept. 23^d 6^h, 153°. Sept. 26^d 21^h, 146°. Oct. 3^d 21^h, 157°.

Sept. 20^d 5^h till 21^d 8^h. Extra observations hourly.

Göttingen Mean Time of Declination Observation.			DECLINA- TION.	BIFILAR.		BALANCE.		Göttingen Mean Time of Declination Observation.			DECLINA- TION.	BIFILAR.		BALANCE.			
				Cor- rected.	Thermo- meter.	Cor- rected.	Thermo- meter.					Cor- rected.	Thermo- meter.				
d.	h.	m.	'	Sc. Div.	°	Mic. Div.	°	d.	h.	m.	'	Sc. Div.	°	Mic. Div.	°		
Oct.	5	20	0	125.37	540.5	50.0	760.8	50.0	Oct.	19	20	0	126.15	536.3	49.1	773.5	51.6
		23	0	129.35	525.3	50.8	765.3	50.5			23	0	131.22	529.3	50.7	757.1	52.6
Oct.	6	2	0	134.11	540.2	54.2	758.6	53.1	Oct.	20	2	0	135.86	545.7	53.0	759.3	54.2
		5	0	130.18	542.1	55.2	781.7	54.3			5	0	130.98	550.7	54.9	763.1	56.2
		20	0	124.59	541.4	50.8	763.7	50.6			20	0	125.68	524.5	42.0	758.1	44.0
		23	0	127.27	525.5	52.4	766.1	51.8			23	0	127.50	526.4	44.7	786.2	46.2
Oct.	7	2	0	135.59	535.8	54.9	752.7	54.0	Oct.	21	2	0	133.65	541.1	51.3	766.0	51.6
		5	0	130.23	551.1	57.3	750.4	56.1			5	0	126.82	546.1	52.5	775.1	52.9
		20	0	126.12	528.8	45.8	776.3	46.6			20	0	124.48	535.6	47.1	756.3	45.7
		23	0	132.25	518.5	45.8	780.9	46.5			23	0	127.85	517.7	46.0	766.1	47.0
Oct.	8	2	0	136.80	540.7	49.7	783.9	48.8	Oct.	22	2	0	132.58	535.0	47.7	767.3	47.9
		5	0	129.23	550.5	56.3	784.7	54.1			5	0	126.90	540.9	48.2	766.2	48.2
Oct.	9	20	0	124.65	538.0	50.5	754.6	50.3	Oct.	23	20	0	124.40	529.8	43.0	768.3	42.8
		23	0	128.63	532.7	51.6	746.8	51.1			23	0	130.05	521.0	43.2	787.2	43.7
Oct.	10	2	0	131.98	544.3	54.4	746.3	53.3	Oct.	24	2	0	133.07	533.9	51.1	773.0	51.6
		5	0	126.45	542.8	56.4	744.1	55.3			5	0	126.52	538.0	52.6	776.6	53.0
		20	0	124.95	541.5	53.6	747.8	53.1			20	0	124.86	530.4	38.6	762.9	40.1
		23	0	128.10	535.7	55.4	742.3	54.6			23	0	127.80	524.6	38.0	775.0	39.1
Oct.	11	2	0	130.89	544.7	60.0	726.3	58.7	Oct.	25	2	0	130.78	541.2	47.2	776.4	48.5
		5	0	126.26	547.7	62.9	729.3	61.2			5	0	127.10	534.8	49.8	785.5	50.7
		20	0	124.42	535.0	47.8	758.6	48.6			20	0	125.86	531.5	38.6	764.1	40.5
		23	0	125.92	519.3	47.7	771.7	48.0			23	0	129.72	524.6	39.1	771.4	40.7
Oct.	12	2	0	131.36	534.9	52.1	758.8	51.1	Oct.	26	2	0	131.92	540.8	49.2	775.6	51.1
		5	0	126.28	547.9	57.4	744.3	55.4			5	0	128.60	544.3	50.7	767.9	51.6
		20	0	124.35	535.4	44.3	762.0	45.1			20	0	128.41	543.0	46.5	762.1	48.4
		23	0	127.50	536.7	48.1	786.8	49.0			23	0	130.23	532.5	50.4	755.2	51.8
Oct.	13	2	0	134.50	542.1	59.9	719.0	59.5	Oct.	27	2	0	136.53	545.6	55.3	747.0	56.7
		5	0	133.30	542.3	60.5	815.2	59.6			5	0	129.53	543.0	54.3	794.6	56.0
		20	0	132.97	531.8	50.5	750.8	50.7			20	0	128.70	528.6	44.4	751.3	45.4
		23	0	125.99	527.5	51.6	758.8	51.4			23	0	129.30	532.9	45.5	771.8	46.5
Oct.	14	2	0	131.89	538.4	55.7	742.4	54.6	Oct.	28	2	0	131.50	541.0	53.9	751.0	54.5
		5	0	133.44	532.7	57.5	826.6	56.5			5	0	130.47	539.0	53.8	769.2	54.4
		20	0	125.42	536.6	51.9	755.1	52.0			20	0	125.99	533.5	46.5	755.5	48.1
		23	0	130.18	528.0	52.7	757.7	52.4			23	0	127.32	534.7	50.9	768.5	51.4
Oct.	15	2	0	132.50	544.5	57.3	749.1	55.9	Oct.	29	2	0	131.45	536.1	52.4	763.1	52.9
		5	0	127.20	547.4	60.6	739.1	59.0			5	0	128.95	542.6	55.5	759.6	56.2
Oct.	16	20	0	126.05	534.4	50.0	749.7	49.9	Oct.	30	20	0	125.15	537.5	47.2	742.7	47.3
		23	0	128.80	518.3	49.8	755.0	49.7			23	0	125.60	538.5	49.5	764.5	49.3
Oct.	17	2	0	132.27	537.6	50.7	763.6	50.3	Oct.	31	2	0	129.08	546.2	55.8	739.8	55.6
		5	0	116.43	547.0	51.0	792.3	50.6			5	0	124.95	537.5	55.6	763.8	55.7
		20	0	126.46	529.3	46.5	758.1	46.9			20	0	124.95	544.5	56.7	724.7	57.7
		23	0	126.45	523.7	46.0	762.1	46.4			23	0	127.67	537.2	56.7	735.8	57.6
Oct.	18	2	0	130.92	548.7	57.4	747.5	57.9	Nov.	1	2	0	130.47	548.8	60.7	715.5	61.0
		5	0	126.30	542.2	57.5	767.2	57.6			5	0	127.34	548.5	64.2	705.3	63.7
		20	0	122.84	524.1	41.2	754.9	42.1			20	0	126.28	537.9	58.5	716.3	59.7
		23	0	130.22	525.0	41.7	866.0	42.2			23	0	129.50	535.4	57.7	719.1	58.7
Oct.	19	2	0	134.30	530.2	43.1	880.6	43.3	Nov.	2	2	0	133.88	541.0	57.7	740.5	58.7
		5	0	128.17	539.2	44.5	784.2	44.0			5	0	130.16	538.5	57.7	769.8	58.7

BIFILAR. $k=0.0001248$ $q=0.000304=2.44$ Scale divisions.
 BALANCE. April 17^d—Oct. 8^d $k=0.0000130$ $q=0.000073=5.60$ Micrometer divisions.
 „ Oct. 9^d—Dec. 31^d $k=0.0000143$ $q=0.000073=5.10$ Micrometer divisions.
 DECLINATION. Torsion removed. Circle reading 157°. Oct. 10^d 21^h, 166°. Oct. 17^d 21^h, 166°. Oct. 24^d 21^h, 173°. Oct. 31^d 21^h, 186°.

Oct. 17^d—18^d. Extra observations.

Oct. 23^d. Anemometer erected.

Göttingen Mean Time of Declination Observation.			DECLINA- TION.	BIFILAR.		BALANCE.		Göttingen Mean Time of Declination Observation.			DECLINA- TION.	BIFILAR.		BALANCE.			
				Cor- rected.	Thermo- meter.	Cor- rected.	Thermo- meter.					Cor- rected.	Thermo- meter.				
d.	h.	m.		Sc. Div.	°	Mic. Div.	°	d.	h.	m.		Sc. Div.	°	Mic. Div.	°		
Nov.	2	20	0	128.60	536.0	51.6	734.2	52.6	Nov.	16	20	0	124.17	536.7	49.3	745.5	51.1
				131.55	538.8	52.4	749.6	53.5					126.43	534.6	50.5	747.2	52.0
Nov.	3	2	0	135.05	547.6	54.9	753.2	55.0	Nov.	17	2	0	128.15	543.6	55.0	742.7	56.3
				133.57	544.0	57.7	757.7	57.8					125.62	547.3	56.7	742.9	58.1
				125.25	537.2	51.1	754.8	51.1					125.17	530.8	46.8	726.9	48.1
				128.78	535.3	51.6	765.8	51.6					126.28	532.6	48.8	751.5	50.2
Nov.	4	2	0	131.18	546.9	55.6	754.3	55.7	Nov.	18	2	0	127.50	545.3	55.3	741.6	56.3
				127.70	545.8	56.3	752.8	56.4					125.65	548.5	56.2	734.9	57.3
				127.57	533.8	49.2	759.4	50.6					125.20	541.2	47.4	742.8	49.1
				129.01	529.8	50.9	765.7	52.3					127.68	535.2	48.9	747.6	50.4
Nov.	5	2	0	131.27	542.7	54.5	755.9	55.8	Nov.	19	2	0	129.14	545.8	51.9	751.7	52.9
				127.65	544.2	55.3	760.8	56.8					126.88	549.4	57.8	727.6	58.5
Nov.	6	20	0	125.60	538.1	42.8	755.3	43.0	Nov.	20	20	0	127.94	539.4	39.4	730.9	40.0
				125.15	526.0	42.7	758.9	42.9					128.98	528.8	41.0	747.6	41.9
Nov.	7	2	0	129.58	544.1	49.3	765.6	49.7	Nov.	21	2	0	130.72	548.6	47.4	763.3	47.6
				126.82	546.4	53.9	738.8	53.8					127.63	542.2	51.5	752.8	51.9
				125.83	542.7	50.3	745.5	51.8					134.82	500.2	43.4	647.5	45.1
				126.43	538.1	52.6	750.2	54.4					133.47	532.1	47.7	747.6	49.4
Nov.	8	2	0	128.40	546.2	56.5	730.4	57.5	Nov.	22	2	0	133.57	528.7	50.8	807.0	52.3
				126.62	548.5	57.1	730.2	58.3					127.03	539.6	51.9	828.8	53.6
				125.25	547.5	51.9	731.2	53.4					128.34	537.7	45.2	710.7	47.3
				127.23	541.1	52.7	733.6	54.1					130.98	508.1	43.0	761.1	45.0
Nov.	9	2	0	129.10	546.3	58.7	719.7	60.0	Nov.	23	2	0	129.95	533.9	43.1	752.7	44.6
				125.68	545.6	57.4	730.9	58.4					125.72	531.9	43.7	769.5	44.2
				126.02	543.8	48.4	703.7	50.1					125.95	530.1	35.2	760.6	35.9
				134.95	521.1	48.5	744.9	50.3					128.07	527.6	36.7	758.6	36.4
Nov.	10	2	0	138.37	548.4	54.4	776.5	55.4	Nov.	24	2	0	127.92	528.3	37.6	762.3	37.5
				126.97	544.0	55.5	800.9	56.7					123.64	519.5	38.9	792.3	38.5
				132.64	521.9	49.4	718.4	50.6					125.97	538.0	40.5	742.5	40.3
				126.70	530.3	50.2	755.1	51.3					125.79	534.0	41.1	745.5	40.9
Nov.	11	2	0	130.52	539.9	57.8	750.0	59.2	Nov.	25	2	0	129.80	532.9	42.1	747.1	41.8
				122.44	539.7	55.9	789.8	57.3					126.12	537.6	42.7	754.3	42.5
				126.02	535.2	53.3	749.4	54.9					127.57	548.5	56.3	712.5	57.9
				128.08	537.0	52.5	745.8	53.9					129.90	543.6	57.5	722.0	59.2
Nov.	12	2	0	129.72	541.7	56.4	744.6	57.4	Nov.	26	2	0	131.23	546.5	56.9	728.1	58.9
				127.17	544.3	58.3	744.5	59.4					128.90	549.5	59.6	719.3	61.3
Nov.	13	20	0	126.45	533.0	41.9	742.4	42.5	Nov.	27	20	0	127.08	539.0	42.0	740.0	42.3
				125.83	535.9	43.5	760.9	43.9					127.61	542.8	48.6	737.3	48.6
Nov.	14	2	0	128.98	547.3	52.5	743.3	52.2	Nov.	28	2	0	129.30	550.9	55.3	716.1	55.2
				126.66	546.2	54.5	733.5	54.6					127.48	554.9	57.0	707.8	57.4
				126.05	531.0	42.6	749.9	44.6					127.17	549.2	52.9	714.1	55.2
				125.90	537.4	48.4	754.5	50.8					123.85	552.3	57.8	719.2	57.9
Nov.	15	2	0	126.15	546.6	53.4	744.2	55.2	Nov.	29	2	0	130.33	546.5	57.4	717.5	58.8
				125.19	548.9	55.8	741.4	57.5					123.78	553.4	57.5	720.4	59.1
				125.30	536.1	47.8	744.3	49.8					122.67	541.4	47.8	706.9	49.3
				127.81	534.6	48.4	753.1	50.2				
Nov.	16	2	0	129.14	535.8	53.3	754.9	55.1	Dec.	3	2	0
				127.63	543.2	54.1	766.1	56.0					123.22	549.2	51.3	710.3	50.6

BIFILAR. $k=0.0001248$ $q=0.000304=2.44$ Scale divisions.

BALANCE. $k=0.0000143$ $q=0.000073=5.10$ Micrometer divisions.

DECLINATION. Torsion removed. Circle reading 186° . Nov. 7^d 21^h, 200° . Nov. 11^d 6^h, 150° . (See note below.) Nov. 14^d 21^h, 165° . Nov. 28^d 21^h, 172° .

Nov. 3^d 8^h; 5^d 4^h; 9^d 10^h; 19^d 6^h; 21^d—22^d. Extra observations.

Nov. 11^d 6^h. On removing the Declination magnet, in order to make the Dip observation, the suspension cylinder was not held sufficiently hard down, so that the fibres became loose. The torsion was removed.

Nov. 29^d 23^h. Dec. 3^d 2^h. Observer in Edinburgh on business connected with the observatory.

Göttingen Mean Time of Declination Observation.			DECLINA- TION.	BIFILAR.		BALANCE.		Göttingen Mean Time of Declination Observation.			DECLINA- TION.	BIFILAR.		BALANCE.			
				Cor- rected.	Thermo- meter.	Cor- rected.	Thermo- meter.					Cor- rected.	Thermo- meter.				
Dec. 4	d.	h.	m.		Sc. Div.	°	Mic. Div.	°	Dec. 18	d.	h.	m.	Sc. Div.	°	Mic. Div.	°	
	20	0	0	122-70	547-1	48-8	710-5	48-8		20	0	0	123-87	538-0	43-4	726-6	43-9
Dec. 5	23	0	0	123-07	545-9	52-9	706-2	52-4	Dec. 19	23	0	0	125-79	539-5	46-4	734-7	46-7
	2	0	0	124-42	553-0	57-5	693-1	57-3		2	0	0	127-83	552-0	53-8	710-1	53-6
Dec. 6	5	0	0	124-83	553-5	57-1	697-6	57-3	Dec. 20	5	0	0	126-00	547-8	56-4	711-3	56-7
	20	0	0	129-55	534-5	52-8	711-4	54-1		20	0	0	124-24	547-8	54-3	705-6	55-4
Dec. 7	23	0	0	124-82	542-0	54-3	709-5	55-4	Dec. 21	23	0	0	126-08	545-3	54-4	706-5	55-5
	2	0	0	127-52	539-8	55-0	723-3	55-9		2	0	0	127-17	546-1	56-4	712-1	57-3
Dec. 8	5	0	0	124-25	546-7	54-4	726-7	55-1	Dec. 22	5	0	0	125-70	550-1	57-1	705-2	58-3
	20	0	0	125-75	541-4	51-3	695-4	52-1		20	0	0	124-46	551-5	58-6	683-0	60-0
Dec. 9	23	0	0	125-55	536-8	50-1	705-0	50-8	Dec. 23	23	0	0	125-20	547-5	56-8	686-3	58-3
	2	0	0	128-28	542-4	49-5	717-7	50-0		2	0	0	127-47	551-0	56-0	697-6	57-4
Dec. 10	5	0	0	129-03	531-0	49-0	753-0	49-4	Dec. 24	5	0	0	126-17	553-9	61-6	687-9	63-3
	20	0	0	124-60	543-0	46-7	716-1	46-8		20	0	0	126-90	548-9	59-9	692-6	62-2
Dec. 11	23	0	0	124-66	535-5	47-1	720-2	46-9	Dec. 25	23	0	0	129-52	547-5	58-7	673-4	60-3
	2	0	0	128-27	539-1	48-7	736-8	48-0		2	0	0	129-03	548-3	58-4	701-4	59-8
Dec. 12	5	0	0	118-83	544-2	53-9	701-7	53-6	Dec. 26	5	0	0	128-27	548-4	58-8	709-0	60-7
	20	0	0	125-45	549-8	52-2	707-9	53-2		20	0	0	126-02	544-0	52-9	707-5	55-4
Dec. 13	23	0	0	125-93	541-5	53-4	715-5	54-3	Dec. 27	23	0	0	128-92	540-4	53-0	722-8	55-7
	2	0	0	127-54	542-9	53-8	712-8	54-7		2	0	0	129-72	547-5	55-3	709-6	57-5
Dec. 14	5	0	0	125-95	539-4	56-3	755-1	57-3	Dec. 28	5	0	0	127-40	544-8	57-2	714-8	59-7
	20	0	0	123-93	542-8	53-0	728-5	54-3		20	0	0	126-12	538-2	46-4	734-4	48-6
Dec. 15	23	0	0	124-42	534-1	51-6	731-7	52-6	Dec. 29	23	0	0	126-97	544-9	49-8	728-0	52-2
	2	0	0	126-42	544-4	54-0	738-0	55-4		2	0	0	126-33	551-0	52-5	714-9	54-0
Dec. 16	5	0	0	124-30	545-5	55-3	729-6	56-3	Dec. 30	5	0	0	124-88	545-9	50-9	721-4	52-4
	20	0	0	123-20	540-1	44-9	737-6	45-8		20	0	0	124-27	547-0	47-8	700-7	47-6
Dec. 17	23	0	0	124-82	542-1	49-0	739-6	49-1	Dec. 31	23	0	0	126-43	545-9	49-4	709-0	49-1
	2	0	0	125-55	548-3	54-4	715-8	54-1		2	0	0	126-80	548-9	54-8	687-6	54-3
Dec. 18	5	0	0	124-00	552-2	56-3	701-2	56-1	Dec. 32	5	0	0	124-39	550-3	55-2	695-4	55-7
	20	0	0	123-18	549-2	57-6	696-0	58-2		20	0	0	124-55	539-2	45-7	705-8	47-9
Dec. 19	23	0	0	125-75	545-2	57-4	695-6	58-0	Dec. 33	23	0	0	125-59	548-5	51-0	710-2	53-2
	2	0	0	127-03	550-7	57-3	693-2	57-7		2	0	0	127-17	553-2	52-8	709-1	54-2
Dec. 20	5	0	0	125-08	557-2	58-8	700-7	59-7	Dec. 34	5	0	0	126-28	552-5	53-9	702-3	55-4
	20	0	0	125-95	545-1	60-4	688-4	62-2		20	0	0	124-32	541-0	45-5	717-3	47-9
Dec. 21	23	0	0	125-72	537-9	57-9	695-4	59-2	Dec. 35	23	0	0	125-49	545-2	48-8	726-0	51-1
	2	0	0	128-07	543-9	56-5	699-3	57-7		2	0	0	126-90	555-1	53-6	707-7	55-1
Dec. 22	5	0	0	124-55	543-8	54-9	705-5	55-9	Dec. 36	5	0	0	125-73	549-2	54-6	699-0	56-0
	20	0	0	124-70	543-3	52-6	708-0	52-4		20	0	0	123-97	546-8	53-3	698-1	54-5
Dec. 23	23	0	0	125-37	541-2	52-9	712-3	52-6	Dec. 37	23	0	0	125-60	542-6	53-4	708-0	54-4
	2	0	0	127-50	547-5	54-0	722-6	53-9		2	0	0	127-23	547-6	54-3	714-8	55-1
Dec. 24	5	0	0	125-08	552-3	58-4	704-3	58-3	Dec. 38	5	0	0	125-20	553-2	59-4	687-5	60-3
	20	0	0	124-13	545-4	56-8	699-2	57-9		20	0	0	124-37	547-8	58-0	677-2	59-5
Dec. 25	23	0	0	125-72	537-8	55-5	697-5	56-5	Dec. 39	23	0	0	125-42	548-1	58-1	693-8	59-3
	2	0	0	126-95	547-9	57-5	708-2	58-3		2	0	0	131-76	546-2	61-9	696-3	62-8
Dec. 26	5	0	0	121-86	549-3	58-7	703-9	59-7	Dec. 40	5	0	0	127-74	535-1	61-6	706-1	62-8
	20	0	0	124-32	541-9	55-9	700-6	57-9		20	0	0	125-79	550-2	58-3	676-1	59-2
Dec. 27	23	0	0	125-82	543-3	53-8	721-7	55-8	Dec. 41	23	0	0	128-10	545-8	58-9	693-4	59-9
	2	0	0	126-55	550-7	56-5	711-5	58-2		2	0	0	129-32	549-4	59-6	685-7	60-6
Dec. 28	5	0	0	125-35	549-4	57-8	711-0	59-9	Dec. 42	5	0	0	126-98	548-7	59-4	694-1	61-2

BIFILAR. $k=0.0001248$ $q=0.000304=2.44$ Scale divisions.

BALANCE. $k=0.0000143$ $q=0.000073=5.10$ Micrometer divisions.

DECLINATION. Torsion removed. Circle reading 172° . Dec. 5^d 21^h, 172° . Dec. 12^d 21^h, 165° . Dec. 19^d 21^h, 168° .

Dec. 5^d 20^h; 9^d 5^h; 17^d 4^h. Extra observations.

TERM-DAY OBSERVATIONS

OF

MAGNETOMETERS.

1841 AND 1842.

JULY 21, 22.																		
Göttingen Mean Time of Declination Observation.	DECLINA- TION.	BIFILAR Corrected.	BALANCE Corrected.	DECLINA- TION.	BIFILAR Corrected.	BALANCE Corrected.	DECLINA- TION.	BIFILAR Corrected.	BALANCE Corrected.	DECLINA- TION.	BIFILAR Corrected.	BALANCE Corrected.						
	Min.	Sec. Div.	Mic. Div.	Sec. Div.	Mic. Div.	Sec. Div.	Mic. Div.	Sec. Div.	Mic. Div.	Sec. Div.	Mic. Div.	Mic. Div.						
		10 ^h .		14 ^h .		18 ^h .		22 ^h .										
0	129-80	497-8	130-23	487-6	777-7	124-95	481-0	696-7	136-41	456-2	738-3						
5	130-47	126-60	134-33						
10	492-9	129-90	489-4	126-98	475-0	695-6	131-23	460-8	735-7						
15	129-52	784-3	130-00	127-54	133-72						
20	130-09	494-7	131-20	486-4	128-38	475-4	133-57	461-8	736-1						
25	130-35	782-1	132-91	774-4	129-52	695-9	132-84						
30	130-03	494-2	481-0	130-40	474-0	131-95	462-4	735-8						
35	129-98	781-5	133-28	774-6	131-73	696-8	131-25						
40	129-35	491-2	134-39	482-7	131-17	469-6	130-36	466-1	730-1						
45	128-76	781-6	135-12	768-2	131-22	700-3	130-18						
50	128-65	490-1	135-42	481-3	131-55	466-5	130-18	466-6	733-9						
55	128-56	780-0	135-62	760-8	131-57	703-4	129-09						
		11 ^h .		15 ^h .		19 ^h .		23 ^h .										
0	128-85	490-6	134-86	474-9	751-9	132-80	459-9	707-3	129-47	466-5	734-1						
5	129-09	778-8	135-30	132-25	127-95						
10	129-29	493-0	136-20	474-7	130-42	462-6	708-7	128-98	466-3	733-8						
15	130-43	779-7	137-41	747-1	128-50	128-27						
20	130-60	491-9	138-37	464-0	127-80	460-1	713-6	128-96	473-0	735-7						
25	131-18	779-4	137-61	728-8	127-94	129-15						
30	130-55	490-5	137-21	448-2	128-05	462-1	129-23	471-7	737-6						
35	130-05	779-9	137-20	713-3	126-63	716-2	129-50						
40	129-76	490-9	137-23	444-4	127-70	463-7	718-2	129-78	474-1	739-0						
45	129-20	780-4	139-07	703-3	129-18	130-35						
50	129-18	491-1	142-77	440-8	130-43	464-0	719-7	130-13	474-8	740-1						
55	129-29	781-4	145-59	705-3	130-07	130-76						
		12 ^h .		16 ^h .		20 ^h .		0 ^h .										
0	129-09	490-9	146-83	459-0	702-1	129-13	471-3	724-2	130-72	473-9	747-5						
5	129-12	783-2	146-80	130-07	130-83						
10	129-15	491-7	145-23	473-8	128-75	468-4	725-9	131-27	476-0	742-3						
15	129-50	781-6	143-27	695-3	130-72	131-42						
20	129-29	491-2	141-47	475-8	132-48	468-6	131-80	477-9	741-8						
25	129-12	780-9	139-67	690-6	133-33	727-4	131-95						
30	129-25	490-9	137-41	474-0	133-37	467-8	728-1	132-57	479-9	742-1						
35	129-12	780-3	134-50	686-3	134-03	133-22						
40	129-25	490-6	132-45	475-3	133-60	461-3	729-9	133-00	483-0	741-9						
45	129-35	779-6	130-92	684-6	130-56	133-95						
50	129-52	492-5	130-03	479-1	129-78	457-3	730-5	134-15	483-9	741-7						
55	130-05	778-9	129-78	686-1	130-69	133-85						
		13 ^h .		17 ^h .		21 ^h .		1 ^h .										
0	130-35	491-6	129-07	481-2	687-3	129-78	447-3	735-2	134-10	484-9	744-8						
5	129-67	778-2	127-98	129-27	134-17						
10	129-78	490-4	127-92	480-1	131-91	443-2	736-0	134-00	478-8	745-3						
15	129-58	778-1	126-52	686-3	130-76	134-03						
20	129-29	488-7	126-05	485-4	132-08	444-0	735-8	133-93	475-6	745-8						
25	128-92	778-0	126-52	686-9	132-13	134-22						
30	128-52	488-5	125-52	477-2	131-97	453-2	736-4	134-02	478-0	745-2						
35	129-42	778-0	125-97	688-4	131-30	134-28						
40	129-38	488-6	125-88	474-9	132-60	448-2	738-1	134-20	478-3	746-1						
45	129-55	778-0	126-00	694-2	132-04	133-93						
50	129-67	488-2	126-67	472-9	133-73	451-3	738-2	134-23	476-7	746-7						
55	129-82	778-0	126-25	697-3	136-57	133-97						
Hour,			10	11	12	13	14	15	16	17	18	19	20	21	22	23	0	1
BIFILAR THERMOMETER,			62-3	62-4	62-7	62-5	62-3	61-8	61-1	60-6	59-9	59-4	59-3	59-1	58-9	58-6	58-6	58-7
BALANCE THERMOMETER,			62-7	62-2	63-0	62-3	62-2	62-2	61-9	61-2	60-7	59-9	59-7	59-9	59-7	59-2	58-7	59-0

During the Terms of 1841, the Bifilar and Balance Magnetometers were observed 2^m 30^s after the corresponding minutes of Declination observation.
 July 21^d—22^d, 1841. The Bifilar and Balance magnets, during this term, had their N. poles E. and W. respectively; the opposite direction to that which they afterwards occupied. Increasing readings, however, still indicate increasing force; the Bifilar readings having been subtracted from a constant quantity.

Göttingen Mean Time of Declination Observation.	JULY 21, 22.						AUGUST 27, 28.										
	DECLINA- TION.	BIFILAR Corrected.	BALANCE Corrected.	DECLINA- TION.	BIFILAR Corrected.	BALANCE Corrected.	DECLINA- TION.	BIFILAR Corrected.	BALANCE Corrected.	DECLINA- TION.	BIFILAR Corrected.	BALANCE Corrected.					
Min.		Sec. Div.	Mic. Div.		Sec. Div.	Mic. Div.		Sec. Div.	Mic. Div.		Sec. Div.	Mic. Div.					
		2h.			6h.			10h.			14h.						
0	133-47	475-9		130-43	499-2		133-24	555-6		126-14	552-6						
5	134-22		749-4	131-25		765-1	132-44		734-1	124-86		570-2					
10	134-00	476-6		130-69	499-7		130-42	555-4		123-15	566-8						
15	134-10		748-2	130-70		766-4	129-50		732-6	123-02		577-9					
20	133-90	482-2		130-47	498-4		129-09	555-7		122-30	560-3						
25	134-08		748-2	130-56		769-3	128-50		723-7	122-15		598-4					
30	134-33	486-1		130-32	497-6		126-80	555-6		122-60	562-2						
35	133-75		749-9	129-87		770-0	125-42		708-0	122-84		595-9					
40	133-70	481-8		129-83	496-4		128-65	561-0		123-95	561-5						
45	133-77		749-8	129-62		771-6	131-85		673-0	123-92		603-0					
50	133-63	485-8		129-63	499-6		132-93	538-6		124-13	561-5						
55	133-58		751-1	129-23		774-0	130-50		669-5	124-08		611-8					
		3h.			7h.			11h.			15h.						
0	133-63	481-9		128-92	498-8		125-87	534-9		122-87	560-1						
5	133-20		751-7	129-22		773-1	121-42		679-6	123-79		621-6					
10	132-88	481-9		128-60	499-9		121-18	546-4		122-88	556-5						
15	133-00		754-3	128-63		773-0	123-07		682-6	123-52		626-8					
20	133-04	482-8		128-21	502-0		125-52	546-1		123-48	555-8						
25	133-07		755-6	128-82		774-2	126-90		685-1	125-02		637-4					
30	133-13	487-4		128-90	499-3		129-45	555-2		126-23	553-2						
35	132-64		756-6	129-00		773-8	132-35		677-7	126-20		645-7					
40	132-02	486-8		129-27	500-7		132-30	554-4		126-94	553-5						
45	132-68		755-6	129-42		774-1	131-88		670-2	128-32		650-7					
50	132-77	490-0		129-92	500-3		132-18	551-8		128-80	551-7						
55	132-64		756-3	130-52		776-0	131-53		669-7	129-18		656-2					
		4h.			8h.			12h.			16h.						
0	132-57	490-6		130-43	498-8		130-47	552-6		129-33	554-3						
5	132-42		759-3	130-67		767-7	130-25		664-7	130-20		656-8					
10	132-24	488-6		130-62	498-8		129-92	547-3		129-35	555-9						
15	131-97		759-4	130-63		767-3	129-69		660-5	129-83		656-3					
20	132-37	489-0		130-42	499-2		129-58	543-4		127-78	557-1						
25	131-91		758-2	131-08		767-7	130-75		649-8	128-10		656-1					
30	131-91	491-5		130-56	501-0		135-53	542-7		126-95	556-5						
35	131-87		758-4	130-20		765-3	136-45		588-6	129-30		663-9					
40	131-71	494-8		130-13	497-1		130-09	561-7		129-87	554-1						
45	131-90		758-3	129-95		774-6	131-08		447-0	129-49		663-9					
50	131-91	495-1		129-60	495-3		137-15	551-0		130-52	553-3						
55	131-97		758-4	129-20		775-8	142-31		433-6	128-80		668-6					
		5h.			9h.			13h.			17h.						
0	131-33	497-4		129-13	495-6		141-13	539-6		130-69	554-0						
5	131-18		759-7	128-87		776-9	139-09		454-1	131-02		671-2					
10	130-87	497-1		128-50	499-0		134-03	550-4		130-87	553-7						
15	131-17		760-3	128-47		777-4	137-80		477-9	132-25		670-7					
20	131-13	497-1		128-17	498-3		141-71	548-6		133-30	546-8						
25	130-87		759-9	128-12		779-5	142-45		464-0	134-99		676-3					
30	131-08	497-9		128-15	493-4		141-45	538-5		135-55	536-3						
35	130-70		762-3	128-10		779-2	138-67		500-0	135-08		676-5					
40	130-65	494-8		128-03	491-3		136-30	546-7		135-45	534-8						
45	130-53		761-9	128-40		778-8	133-42		524-5	136-23		676-5					
50	130-73	496-0		128-58	491-4		131-15	549-3		136-30	541-7						
55	130-67		764-0	128-55		777-9	128-10		560-5	137-67		679-2					
Hour,		2	3	4	5	6	7	8	9	10	11	12	13	14	15	16	17
BIFILAR THERMOMETER,	58-9	59-5	59-9	59-9	60-0	60-2	59-8	59-6		64-6	64-4	64-4	64-3	64-6	63-7	63-7	63-7
BALANCE THERMOMETER,	59-6	59-7	60-2	60-2	60-7	60-6	59-8	60-3		65-6	65-3	65-8	65-8	65-8	65-5	65-5	65-6

TERM-DAY OBSERVATIONS OF MAGNETOMETERS, 1841.

Göttingen Mean Time of Declination Observation.		AUGUST 27, 28.											
		DECLINA- TION.	BIFILAR Corrected.	BALANCE Corrected.	DECLINA- TION.	BIFILAR Corrected.	BALANCE Corrected.	DECLINA- TION.	BIFILAR Corrected.	BALANCE Corrected.	DECLINA- TION.	BIFILAR Corrected.	BALANCE Corrected.
Min.		Sec. Div.	Mic. Div.		Sec. Div.	Mic. Div.		Sec. Div.	Mic. Div.		Sec. Div.	Mic. Div.	
		18 ^h .			22 ^h .			2 ^h .			6 ^h .		
0	138-61	543-7		135-85	539-5		147-63	554-8		138-30	563-6		
5	138-75		671-7	136-32		711-4	147-47		706-9	138-70		727-4	
10	139-76	542-5		136-50	538-4		146-97	558-6		138-55	566-1		
15	140-85		662-3	137-14		702-8	146-87		704-2	138-57		732-3	
20	141-27	536-8		137-77	537-1		146-40	560-6		136-88	571-6		
25	140-56		651-1	138-58		704-5	146-48		699-5	135-05		744-0	
30	140-38	542-7		138-18	533-1		146-57	562-0		131-80	570-1		
35	142-27		656-5	138-89		708-4	145-77		701-2	129-72		753-6	
40	142-65	542-7		139-35	527-3		145-17	555-0		130-13	573-4		
45	142-40		659-2	140-23		713-8	145-08		700-8	130-76		762-8	
50	140-05	549-8		140-92	523-8		145-32	559-1		130-16	570-2		
55	139-95		657-3	141-75		717-0	145-22		128-89		773-7	
		19 ^h .			23 ^h .			3 ^h .			7 ^h .		
0	139-27	550-0		141-78	523-9		145-19	555-0		128-28	566-7		
5	138-80		662-8	141-50		713-7	144-25		708-2	128-95		773-1	
10	137-75	552-3		141-48	525-8		143-33	559-4		127-15	572-3		
15	138-58		661-5	141-60		711-4	142-38		709-9	129-62		762-9	
20	140-36	555-1		139-82	525-9		142-30	563-9		135-05	568-7		
25	140-98		661-6	140-56		711-5	142-33		713-7	136-67		764-8	
30	140-70	554-6		141-33	533-4		142-31	558-5		136-12	560-0		
35	139-16		660-2	140-76		716-6	141-60		713-4	135-00		760-0	
40	137-90	553-0		142-57	534-8		141-22	563-6		135-88	557-2		
45	136-35		663-9	144-08		718-5	141-18		708-8	135-12		761-4	
50	135-68	547-1		144-30	539-4		141-18	565-3		134-50	559-6		
55	136-32		673-3	144-19		718-8	141-51		707-1	134-77		756-2	
		20 ^h .			0 ^h .			4 ^h .			8 ^h .		
0	137-18	545-4		144-77	544-6		141-84	570-9		134-90	561-2		
5	138-01		676-4	144-33		721-0	141-98		710-5	134-03		758-0	
10	137-88	545-2		144-42	547-5		142-18	563-9		133-30	562-9		
15	136-63		679-5	145-85		718-6	142-65		712-3	133-72		758-4	
20	136-38	546-3		146-77	546-5		142-38	553-4		133-68	559-7		
25	136-85		683-3	145-72		716-3	142-07		706-8	134-22		758-6	
30	136-37	544-4		144-63	549-9		141-82	556-4		133-10	554-5		
35	135-77		688-6	144-95		706-0	141-57		698-5	132-31		752-1	
40	136-13	541-8		145-72	552-1		140-98	562-5		133-31	559-8		
45	137-27		692-8	145-92		701-5	140-83		695-9	133-95		748-4	
50	137-94	547-4		145-37	551-6		140-56	561-4		134-20	558-5		
55	137-57		695-1	146-25		696-5	140-20		691-5	133-83		748-0	
		21 ^h .			1 ^h .			5 ^h .			9 ^h .		
0	137-17	544-9		146-35	556-3		139-72	563-4		134-68	556-6		
5	136-08		695-5	147-40		696-3	139-72		692-0	135-68		746-8	
10	135-42	541-3		146-92	555-6		139-72	565-0		136-15	557-1		
15	134-12		696-5	147-43		700-3	139-63		697-9	135-75		739-8	
20	135-82	543-7		147-03	556-3		139-38	561-7		135-77	555-5		
25	135-85		697-1	147-03		701-5	139-10		701-6	135-06		737-2	
30	136-02	543-2		147-03	558-3		139-29	563-3		134-08	555-9		
35	136-78		700-0	148-25		709-2	139-13		713-5	133-88		734-2	
40	137-34	543-1		148-12	548-8		139-13	565-3		133-60	555-6		
45	137-01		703-7	147-65		713-2	139-23		708-1	133-55		734-2	
50	136-12	540-1		147-45	550-6		139-23	563-6		133-00	554-7		
55	136-34		705-7	147-61		711-3	139-00		708-6	133-00		733-1	

HOUR,	18	19	20	21	22	23	0	1	2	3	4	5	6	7	8	9	10
BIFILAR THERMOMETER.	63-6	63-3	63-0	63-1	63-7	64-5	65-4	66-4	67-7	68-7	69-6	69-8	70-3	70-2	69-5	69-0	68-6
BALANCE THERMOMETER.	65-6	64-7	63-8	64-3	64-3	65-0	66-0	66-4	67-4	68-0	68-8	67-8	68-0	67-8	68-7	68-8	68-8

SEPTEMBER 22, 23.																	
Göttingen Mean Time of Declination Observation.	DECLINA- TION.	BIFILAR Corrected.	BALANCE Corrected.	DECLINA- TION.	BIFILAR Corrected.	BALANCE Corrected.	DECLINA- TION.	BIFILAR Corrected.	BALANCE Corrected.	DECLINA- TION.	BIFILAR Corrected.	BALANCE Corrected.					
	Min.	Sc. Div.	Mic. Div.	Sc. Div.	Mic. Div.	Sc. Div.	Sc. Div.	Mic. Div.	Mic. Div.	Sc. Div.	Mic. Div.	Mic. Div.					
		10 ^h .		14 ^h .		18 ^h .		22 ^h .									
0	129.73	542.6		135.68	536.5		133.40	536.3		134.26	519.6						
5	129.73		597.4	135.68		649.5	133.28		656.9	134.82		647.3					
10	130.92	535.4		135.40	535.9		133.45	535.8		135.02	521.4						
15	131.08		599.3	135.28		650.0	133.48		656.9	135.72		645.3					
20	128.37	530.7		134.82	535.6		133.77	535.0		136.08	519.4						
25	126.17		601.2	134.13		649.4	133.88		658.6	136.55		645.8					
30	127.03	535.4		134.95	535.0		133.73	535.0		136.34	519.4						
35	128.55		608.2	134.23		650.0	133.47		659.0	136.65		647.8					
40	129.58	532.1		134.06	536.0		135.46	532.9		137.03	515.7						
45	130.20		614.2	134.03		651.0	133.30		659.9	137.08		647.6					
50	130.85	531.2		134.20	536.2		133.24	537.6		136.95	515.2						
55	131.08		621.6	134.00		649.8	133.66		661.4	137.34		646.4					
		11 ^h .		15 ^h .		19 ^h .		23 ^h .									
0	131.47	531.1		133.73	535.6		133.75	534.4		137.28	515.0						
5	132.25		628.9	133.47		649.1	133.22		661.6	137.43		648.4					
10	132.55	532.4		133.04	534.2		132.80	535.6		137.83	516.9						
15	133.18		634.1	132.85		649.2	132.93		658.0	138.10		647.5					
20	133.82	533.2		132.77	534.2		132.98	534.8		138.35	518.2						
25	133.95		635.7	133.00		657.0	133.08		656.5	139.18		649.7					
30	134.23	533.4		133.22	534.9		132.97	534.2		138.63	517.7						
35	137.41		638.3	132.98		658.2	132.97		654.8	139.30		647.8					
40	133.73	535.0		133.20	534.5		133.08	534.8		139.10	520.2						
45	134.05		639.9	133.33		657.9	133.79		656.0	139.27		647.1					
50	134.33	533.8		133.65	535.9		131.77	533.6		139.35	520.8						
55	134.86		643.5	133.65		655.2	132.62		653.9	139.83		645.8					
		12 ^h .		16 ^h .		20 ^h .		0 ^h .									
0	134.63	533.6		134.62	533.5		132.02	532.9		139.72	519.8						
5	134.43		645.7	133.30		656.8	132.93		653.3	139.95		645.5					
10	134.72	535.1		132.64	534.4		132.87	531.8		140.65	522.1						
15	135.02		646.4	132.38		657.0	132.67		654.9	141.32		643.0					
20	134.60	536.8		132.40	533.6		132.38	529.9		141.23	522.3						
25	134.73		645.7	132.20		659.8	132.20		653.2	141.03		642.2					
30	134.73	538.3		134.32	533.7		131.95	530.0		141.03	525.2						
35	134.77		649.7	134.59		659.5	133.20		652.9	141.18		641.3					
40	134.57	537.2		134.55	534.6		133.51	529.1		141.07	523.7						
45	134.42		644.1	134.40		659.5	133.45		654.3	141.38		641.4					
50	134.45	537.2		133.93	533.1		133.44	526.8		139.98	521.7						
55	134.19		647.4	133.73		659.7	133.02		653.8	140.87		643.6					
		13 ^h .		17 ^h .		21 ^h .		1 ^h .									
0	134.23	536.6		133.83	534.4		133.90	524.9		141.00	522.9						
5	134.05		649.7	134.72		659.2	132.88		653.4	140.83		645.3					
10	134.17	536.2		134.73	533.9		132.30	524.5		140.95	524.3						
15	134.20		648.6	134.46		659.4	132.62		652.8	141.12		643.4					
20	134.28	537.1		134.65	534.7		132.57	524.7		141.45	526.4						
25	134.70		646.0	134.86		660.2	133.40		653.8	141.67		645.8					
30	135.02	537.2		134.62	534.2		133.77	521.7		141.57	526.4						
35	135.35		649.1	133.75		658.0	134.46		654.9	141.55		644.6					
40	135.05	535.3		133.53	535.5		134.62	520.5		141.57	528.2						
45	135.05		651.8	133.58		657.6	134.20		655.8	141.50		645.3					
50	135.53	535.7		133.70	537.4		134.62	519.4		141.38	528.7						
55	135.68		650.3	133.83		655.6	134.57		654.0	141.29		645.2					
Hour,		10	11	12	13	14	15	16	17	18	19	20	21	22	23	0	1
BIFILAR THERMOMETER, . .	60.4?	60.4	60.2	62.3	61.8	61.6	61.6	61.4	61.7	62.4	62.4	61.6	60.9	60.6	60.6	60.6	60.6
BALANCE THERMOMETER, .	60.3?	60.3	60.3	61.8	61.7	61.7	61.7	61.2	61.7	62.4	62.3	61.5	60.9	60.7	60.7	60.7	60.7

TERM-DAY OBSERVATIONS OF MAGNETOMETERS, 1841.

Göttingen Mean Time of Declination Observation.	SEPTEMBER 22, 23.						OCTOBER 20, 21.										
	DECLINA- TION.	BIFILAR Corrected.	BALANCE Corrected.	DECLINA- TION.	BIFILAR Corrected.	BALANCE Corrected.	DECLINA- TION.	BIFILAR Corrected.	BALANCE Corrected.	DECLINA- TION.	BIFILAR Corrected.	BALANCE Corrected.					
	Min.	Sc. Div.	Mic. Div.	Sc. Div.	Mic. Div.	Sc. Div.	Mic. Div.	Sc. Div.	Mic. Div.	Sc. Div.	Mic. Div.	Mic. Div.					
		2 ^h .			6 ^h .			10 ^h .			14 ^h .						
0	141-29	529-0		137-75	542-4		128-30	508-6		117-61	491-8						
5	141-25		645-1	138-08		645-9	128-30		666-1	117-61		572-1					
10	141-15	530-1		138-18	550-7		128-23	509-3		117-15	487-2						
15	141-15		645-7	137-78		646-1	128-10		665-4	117-60		570-3					
20	141-18	529-3		137-52	549-2		128-07	510-5		122-22	476-2						
25	140-92		645-2	137-48		653-5	128-14		664-9	124-70		554-1					
30	140-76	530-1		137-98	537-5		128-14	509-8		129-55	453-4						
35	140-93		647-5	138-07		653-6	127-88		663-2	133-22		507-2					
40	141-20	533-8		138-07	535-2		128-03	509-9		135-86	459-3						
45	141-13		649-2	138-14		656-4	127-77		658-2	135-63		490-7					
50	141-60	536-5		138-23	534-9		127-55	509-6		133-95	478-4						
55	141-64		650-6	138-08		658-3	127-30		659-7	132-20		501-0					
		3 ^h .			7 ^h .			11 ^h .			15 ^h .						
0	141-32	533-7		138-25	536-4		127-03	506-8		131-17	488-9						
5	141-50		654-2	138-28		661-0	126-28		653-3	130-35		498-4					
10	140-32	535-4		138-25	539-6		125-75	505-8		128-93	495-6						
15	141-22		654-9	138-23		663-0	125-94		652-5	127-72		511-4					
20	141-12	537-9		138-01	539-2		125-98	504-0		126-47	505-8						
25	141-18		654-0	138-07		663-0	125-77		652-7	125-57		519-8					
30	141-09	539-4		137-67	538-2		125-52	504-0		125-26	506-0						
35	140-89		653-5	137-80		664-6	125-02		651-8	124-22		530-8					
40	140-87	539-6		137-60	538-8		125-20	504-5		123-65	508-9						
45	140-60		655-9	137-57		665-5	125-78		639-7	122-73		537-2					
50	139-82	535-7		137-45	539-0		126-27	539-0		120-70	507-8						
55	139-72		656-3	137-52		667-6	129-49		601-7	119-89		540-4					
		4 ^h .			8 ^h .			12 ^h .			16 ^h .						
0	532-9		137-74	540-6		131-87	534-1		118-45	507-4						
5	139-45		654-0	138-17		666-7	131-44		565-7	117-58		538-6					
10	139-07	534-3		138-23	538-9		129-27	523-2		116-21	508-4						
15	138-78		652-6	138-21		666-5	128-53		563-2	113-97		527-2					
20	138-67	533-8		138-17	539-6		127-72	513-6		113-02	516-4						
25	138-40		651-1	138-01		667-1	125-39		565-4	112-66		542-9					
30	138-37	536-7		137-98	539-5		122-42	512-4		113-63	515-4						
35	138-30		649-4	137-70		664-4	120-22		563-3	114-77		554-6					
40	138-12	536-6		137-83	539-4		119-73	512-0		114-01	512-4						
45	137-92		649-7	137-58		665-8	118-96		560-0	118-43		562-4					
50	137-78	536-9		137-63	538-9		117-32	503-1		119-22	508-1						
55	138-08		648-7	137-30		665-4	115-74		564-1	121-55		560-5					
		5 ^h .			9 ^h .			13 ^h .			17 ^h .						
0	137-88	540-5		137-57	536-8		115-05	499-9		120-38	510-0						
5	137-75		649-4	137-81		666-2	116-30		570-1	120-52		549-9					
10	137-72	539-3		137-28	539-2		117-70	488-4		120-23	503-3						
15	137-88		649-0	137-37		666-6	116-77		579-3	118-76		538-5					
20	137-48	539-2		137-15	538-6		114-90	494-4		117-14	497-7						
25	137-18		650-4	137-14		665-5	114-97		577-8	118-00		536-5					
30	137-50	538-8		137-17	538-2		116-48	500-3		119-22	486-9						
35	137-57		647-4	137-85		665-7	118-01		572-1	121-07		536-8					
40	137-63	542-3		137-74	538-2		118-45	497-2		121-33	483-4						
45	137-52		648-0	137-83		665-5	117-05		566-3	121-97		534-2					
50	137-55	542-0		137-77	538-7		116-95	493-1		120-75	483-4						
55	137-60		647-0	137-70		667-0	117-75		570-4	122-53						
HOOR,	2	3	4	5	6	7	8	9	10	10	11	12	13	14	15	16	17
BIFILAR THERMOMETER,	60-8	60-9	62-4	63-5	63-5	62-7	62-5	62-0	61-6	52-4	54-0	55-0	53-8	53-2	52-8	52-4	51-2
BALANCE THERMOMETER,	60-9	61-0	62-0	63-0	62-5	62-7	62-7	62-7	62-3	51-6	52-8	54-1	53-6	53-2	53-0	52-8	51-8

Göttingen Mean Time of Declination Observation.		OCTOBER, 20, 21.															
		DECLINATION.	BIFILAR Corrected.	BALANCE Corrected.	DECLINATION.	BIFILAR Corrected.	BALANCE Corrected.	DECLINATION.	BIFILAR Corrected.	BALANCE Corrected.	DECLINATION.	BIFILAR Corrected.	BALANCE Corrected.				
Min.		Sec. Div.	Mic. Div.		Sec. Div.	Mic. Div.		Sec. Div.	Mic. Div.		Sec. Div.	Mic. Div.					
		18 ^h .			22 ^h .			2 ^h .			6 ^h .						
0	122-51	476.1		126-81	488.7		129-15	498.8		122-00	508.8						
5	122-64		530.6	127-77		605.7	129-23		767.7	122-60		696.3					
10	122-38	473.7		128-82	485.9		130-38	501.3		123-43	512.1						
15	123-63		522.9	129-38		606.8	131-27		767.6	124-99		693.6					
20	120-58	480.4		128-20	486.8		131-45	498.9		124-45	489.4						
25	121-90		549.5	129-00		604.8	133-60		757.5	111-95		694.7					
30	123-93	482.8		128-63	486.3		131-87	494.3		108-62	508.8						
35	127-60		533.0	128-75		606.3	132-58		747.8	106-08		698.5					
40	130-33	489.4		129-75	487.6		131-73	500.0		96-85	524.2						
45	132-70		505.1	130-82		610.3	132-08		739.2	100.00		679.0					
50	133-88	499.2		130-16	485.1		131-48	507.0		105-24	510.4						
55	133-37		489.1	129-42		612.5	132-93		727.7	103-29		683.4					
		19 ^h .			23 ^h .			3 ^h .			7 ^h .						
0	135-15	502.9		132-50	490.7		133-27	513.3		104-18	502.1						
5	134-02		479.9	132-95		616.9	133-31		722.1	106-57		683.7					
10	133-04	507.6		132-37	484.8		134-83	516.8		107-54	491.1						
15	131-33		475.6	132-88		623.9	136-94		714.8	106-68		696.1					
20	129-82	510.2		133-02	484.8		137-03	515.2		109-45	504.8						
25	130-16		472.7	136-50		625.2	135-60		720.2	113-38		687.7					
30	128-37	506.9		136-92	493.5		135-82	522.4		117-30	500.3						
35	129-27		484.8	137-40		627.8	137-35		723.6	117-14		669.3					
40	128-76	498.2		138-28	484.9		139-53	518.1		112-20	502.4						
45	129-02		498.9	136-15		631.7	139-70		728.4	113-43		658.4					
50	130-18	495.4		134-48	478.4		137-38	503.5		114-22	498.1						
55	129-18		506.1	134-48		632.5	137-80		731.9	111-09		668.8					
		20 ^h .			0 ^h .			4 ^h .			8 ^h .						
0	125-94	498.8		133-48	478.2		139-00	495.7		116-57	505.0						
5	127-17		519.2	134-32		628.7	136-05		773.7	119-49		654.1					
10	125-46	494.9		135-48	479.6		131-62	496.2		122-15	496.1						
15	125-25		531.5	135-50		629.1	119-73		775.8	123-04		657.2					
20	124-73	496.6		135-12	487.9		111-62	540.9		123-11	491.2						
25	124-57		544.0	135-45		628.5	118-98		747.8	122-30		662.2					
30	124-08	500.2		135-88	494.3		124-00	527.0		122-24	496.3						
35	125-42		559.2	136-37		634.7	127-35		725.6	122-67		663.3					
40	124-82	494.5		137-10	500.0		130-23	509.1		123-83	500.2						
45	125-22		565.6	136-47		642.3	130-30		698.9	125-83		663.8					
50	126-03	505.7		137-28	501.4		130-30	502.7		127-52	498.3						
55	127-03		572.0	137-60		644.9	130-63		680.3	127-45		662.3					
		21 ^h .			1 ^h .			5 ^h .			9 ^h .						
0	126-52	497.7		138-35	496.4		130-80	514.2		127-65	497.6						
5	126-60		574.6	138-20		652.4	130-67		672.4	128-30		664.5					
10	127-07	494.9		138-78	491.6		130-96	517.8		128-30	496.5						
15	127-80		580.2	139-09		663.3	130-72		676.3	128-85		663.4					
20	128-70	490.8		139-25	474.8		130-60	513.3		128-92	497.0						
25	129-82		587.0	139-15		686.8	130-62		676.0	127-10		659.7					
30	130-50	483.6		139-05	476.8		130-42	507.3		126-94	505.3						
35	128-69		593.8	136-90		711.1	130-05		680.2	128-85		656.0					
40	128-50	480.9		137-98	490.0		129-36	504.8		130-33	497.6						
45	128-43		595.8	134-72		744.1	130-42		693.3	130-15		655.0					
50	127-30	481.8		131-35	500.7		129-87	497.3		128-95	503.7						
55	127-32		601.3	129-42		755.3	126-80		703.6	129-12		648.5					
Hour,	18	19	20	21	22	23	0	1	2	3	4	5	6	7	8	9	10
BIFILAR THERMOMETER,	51.6	51.3	50.1	49.1	48.6	49.4	50.4	51.2	52.6	54.6	54.9	54.3	54.6	55.3	54.1	52.8	52.0
BALANCE THERMOMETER,	51.8	51.4	50.6	49.6	48.8	49.1	49.9	50.7	52.1	53.6	53.6	53.4	53.8	54.9	54.5	53.9	53.9

TERM-DAY OBSERVATIONS OF MAGNETOMETERS, 1841.

Göttingen Mean Time of Declination Observation.	NOVEMBER 26, 27.											
	DECLINATION.	BIFILAR Corrected.	BALANCE Corrected.	DECLINATION.	BIFILAR Corrected.	BALANCE Corrected.	DECLINATION.	BIFILAR Corrected.	BALANCE Corrected.	DECLINATION.	BIFILAR Corrected.	BALANCE Corrected.
	Min.	Sc. Div.	Mic. Div.	Sc. Div.	Mic. Div.	Sc. Div.	Mic. Div.	Sc. Div.	Mic. Div.	Sc. Div.	Mic. Div.	
		10 ^h .		14 ^h .		18 ^h .		22 ^h .				
0	129-33	510-7		128-82	513-1		128-92	513-5		129-90	506-0	
5	129-23		634-4	128-93		634-2	128-92		626-3	129-56		614-6
10	128-93	512-6		129-96	512-4		128-92	512-4		130-50	506-9	
15	128-87		635-0	130-07		633-3	128-47		626-4	130-07		614-1
20	128-87	512-2		129-70	510-7		128-17	512-7		130-32	506-9	
25	129-00		635-9	129-65		632-7	128-14		626-8	130-58		610-8
30	128-35	512-3		129-56	509-6		127-78	512-3		130-87	508-1	
35	128-21		636-4	129-76		631-0	128-03		628-5	130-75		611-0
40	128-14	511-2		129-20	509-2		128-14	512-3		130-45	506-4	
45	127-97		635-0	128-34		628-6	128-30		629-2	131-28		611-3
50	127-81	510-8		127-68	509-5		128-62	511-7		130-93	508-3	
55	127-78		636-1	128-00		630-8	128-98		629-6	131-05		610-4
		11 ^h .		15 ^h .		19 ^h .		23 ^h .				
0	127-92	512-9		127-88	508-2		128-98	511-0		130-83	507-7	
5	127-70		634-3	127-63		628-1	128-87		629-8	131-38		610-2
10	127-68	512-5		126-98	508-0		128-89	511-2		131-31	508-6	
15	127-97		636-6	127-00		627-8	129-13		630-2	131-48		606-7
20	127-65	511-6		126-98	507-8		129-40	511-4		132-02	509-1	
25	127-83		638-5	127-15		629-6	129-18		630-4	132-30		607-3
30	127-88	512-6		127-15	509-6		129-07	511-5		132-07	509-5	
35	128-12		638-3	127-81		631-6	129-23		631-6	131-71		604-4
40	128-40	513-0		128-15	510-4		129-13	511-5		131-77	510-0	
45	128-35		638-1	128-34		629-1	129-16		631-1	132-05		606-3
50	128-83	511-3		128-35	511-6		129-25	511-3		132-22	510-5	
55	129-10		639-9	128-60		626-8	129-12		634-2	132-25		605-5
		12 ^h .		16 ^h .		20 ^h .		0 ^h .				
0	129-20	508-5		129-15	512-6		129-10	510-6		132-22	510-1	
5	128-90		639-5	129-22		626-2	129-16		634-0	132-40		605-6
10	128-93	510-0		129-38	511-7		128-98	510-4		132-47	511-4	
15	128-82		639-5	128-60		623-8	129-03		635-2		609-8
20	128-85	512-4		128-21	510-7		129-12	510-0		132-65	511-5	
25	128-60		637-9	127-74		624-1	129-02		633-7	132-71		609-7
30	128-23	509-3		128-34	512-4		128-96	510-2		132-73	511-9	
35	127-85		637-2	128-27		624-1	129-12		633-8	132-71		608-6
40	127-75	510-3		128-37	512-2		129-15	509-2		132-64	510-7	
45	128-03		636-7	128-01		623-8	129-07		633-8	132-48		609-8
50	128-23	512-4		127-81	511-9		129-15	509-0		132-65	509-7	
55	128-53		636-5	127-55		624-4	129-03		634-3	132-53		609-8
		13 ^h .		17 ^h .		21 ^h .		1 ^h .				
0	128-56	510-8		128-00	512-4		129-15	508-5		132-60	508-5	
5	128-37		636-3	128-49		624-9	129-12		633-2	132-75		608-6
10	128-28	509-1		128-78	512-6		129-09	508-3		133-04	510-5	
15	128-56		635-4	129-35		625-4	128-93		632-0	133-30		606-6
20	128-78	510-2		129-40	512-4		129-32	507-8		133-07	510-4	
25	128-75		633-1	129-29		623-9	129-43		631-6	133-27		606-0
30	128-40	508-9		129-22	513-6		129-23	507-0		132-97	511-5	
35	128-08		633-9	129-15		624-9	129-23		628-8	132-85		606-1
40	128-17	508-5		129-27	514-2		129-53	507-3		132-47	512-0	
45	128-20		633-8	129-25		622-2	129-50		624-3	132-48		606-0
50	128-12	510-0		129-93	513-8		129-72	507-3		132-44	512-9	
55	127-95		630-4	129-16		622-5	130-15		623-3	132-00		606-0

Hour,	10	11	12	13	14	15	16	17	18	19	20	21	22	23	0	1
BIFILAR THERMOMETER,	48-0	48-4	48-4	48-6	48-2	47-6	47-6	47-7	47-4	46-9	46-6	46-0	45-5	46-6	48-1	49-1
BALANCE THERMOMETER,	46-1	48-4	47-6	47-8	47-9	47-6	47-6	47-6	47-4	47-4	47-2	46-5	45-8	46-3	47-1	48-1

Göttingen Mean Time of Declination Observation.	NOVEMBER 26, 27.						DECEMBER 22, 23.										
	DECLINA- TION.	BIFILAR Corrected.	BALANCE Corrected.	DECLINA- TION.	BIFILAR Corrected.	BALANCE Corrected.	DECLINA- TION.	BIFILAR Corrected.	BALANCE Corrected.	DECLINA- TION.	BIFILAR Corrected.	BALANCE Corrected.					
	Min.	Se. Div.	Mic. Div.	Se. Div.	Mic. Div.	Se. Div.	Min.	Se. Div.	Mic. Div.	Se. Div.	Mic. Div.						
		2 ^h .			6 ^h .			10 ^h .			14 ^h .						
0	131-91	512-3		131-73	514-2		513-6		515-2						
5	131-87		609-0	131-62		618-1		689-1		638-0					
10	131-77	512-0		131-67	514-5		504-5		514-1						
15	131-80		609-7	130-83		619-4		691-7		632-6					
20	132-02	511-9		130-87	515-0		507-4		516-1						
25	131-98		608-5	130-73		619-7		692-8		627-5					
30	131-98	512-8		130-43	515-7		499-5		516-6						
35	132-08		610-4	130-55		620-2		691-0		623-1					
40	132-27	512-3		130-20	513-9		505-8		515-2						
45	132-35		611-9	129-69		621-8		682-9		620-3					
50	132-35	511-5		129-65	514-6		513-4		516-0						
55	132-44		613-2	129-69		620-5		682-1		619-9					
		3 ^h .			7 ^h .			11 ^h .			15 ^h .						
0	132-40	511-2		129-50	515-6		506-3		515-7						
5	132-40		617-3	129-40		620-0		681-4		617-0					
10	132-70	513-0		129-09	517-2		511-3		517-0						
15	132-85		618-5	129-00		619-0		676-7		615-3					
20	132-93	513-0		129-16	516-6		520-0		515-4						
25	132-40		619-1	129-15		619-1		673-1		612-5					
30	132-33	514-0		129-20	516-0		516-5		515-4						
35	132-33		619-6	129-29		618-2		678-6		612-1					
40	132-35	515-4		129-52	515-8		514-3		515-4						
45	132-42		620-6	129-50		616-5		678-3		610-7					
50	132-38	515-2		129-15	517-5		515-9		516-5						
55	132-33		619-7	129-03		616-1		675-1		609-4					
		4 ^h .			8 ^h .			12 ^h .			16 ^h .						
0	132-37	514-6		129-12	517-1		518-2		516-7						
5	132-33		618-5	129-27		616-7		672-4		607-4					
10	132-33	513-9		129-63	516-0		515-8		515-1						
15	132-33		617-9	129-78		618-8		671-5		606-0					
20	132-24	515-3		129-93	513-6		510-5		514-9						
25	131-95		618-8	129-83		620-0		667-0		605-6					
30	132-33	514-3		129-20	510-4		512-4		515-6						
35	132-33		620-0	127-74		622-2		663-6		606-7					
40	132-27	511-9		126-74	508-6		513-6		517-4						
45	132-27		622-5	125-32		624-7		659-1		606-9					
50	132-37	510-8		124-43	513-7		514-3		514-8						
55	132-15		625-2	125-55		625-0		657-8		603-7					
		5 ^h .			9 ^h .			13 ^h .			17 ^h .						
0	131-84	511-9		126-78	515-8		510-4		517-0						
5	131-84		620-0	127-67		625-0		658-7		602-9					
10	131-67	513-3		128-40	514-2		511-4		518-4						
15	131-88		620-4	128-72		624-5		658-5		598-7					
20	132-33	513-2		125-68	513-1		507-3		514-4						
25	132-35		620-2	124-95		619-2		657-4		596-7					
30	132-50	513-7		124-95	517-7		510-9		520-1						
35	132-33		619-2	125-22		621-9		652-1		594-9					
40	132-27	514-3		125-23	517-3		514-9		518-0						
45	132-27		618-7	126-10		620-7		650-2		594-6					
50	132-33	515-2		126-75	516-2		512-7		520-4						
55	132-27		617-0	126-97		619-9		650-4		595-3					
HOUR,	2	3	4	5	6	7	8	9	10	10	11	12	13	14	15	16	17
BIFILAR THERMOMETER,	49-8	49-2	49-6	50-4	51-4	52-0	52-3	52-6	52-9 ?	41-0	42-9	43-1	44-1	45-0	46-0	46-8	47-6
BALANCE THERMOMETER,	48-8	47-6	48-6	49-1	50-1	51-1	51-1	51-2	51-2 ?	39-7	41-4	41-7	42-5	43-5	44-0	45-1	45-6

Dec. 23^d 0^h, 1841. Discovered the stirrup of the Declinometer resting on the copper ring. The observations before 0^h. were worthless, on this account. The magnet was wound up.

TERM-DAY OBSERVATIONS OF MAGNETOMETERS, 1841.

Göttingen Mean Time of Declination Observation.	DECEMBER 22, 23.											
	DECLINA- TION.	BIFILAR Corrected.	BALANCE Corrected.	DECLINA- TION.	BIFILAR Corrected.	BALANCE Corrected.	DECLINA- TION.	BIFILAR Corrected.	BALANCE Corrected.	DECLINA- TION.	BIFILAR Corrected.	BALANCE Corrected.
	Min.	Sec. Div.	Mic. Div.	Min.	Sec. Div.	Mic. Div.	Min.	Sec. Div.	Mic. Div.	Min.	Sec. Div.	Mic. Div.
		18 ^h .			22 ^h .			2 ^h .			6 ^h .	
0	521.4	514.2	132.97	516.5	133.00	517.2	605.6
5	520.0	596.2	602.7	133.10	613.8	133.10	605.9
10	520.0	507.4	132.91	518.7	133.08	517.3
15	520.0	595.2	599.1	132.93	614.1	133.05	605.9
20	521.6	514.6	132.71	518.8	133.05	516.8
25	521.6	594.7	598.9	132.68	614.2	133.28	604.0
30	522.8	518.1	133.00	519.8	133.86	517.7
35	522.8	588.9	594.8	132.83	611.0	133.07	609.3
40	525.0	515.0	132.68	518.6	133.30	512.3
45	525.0	589.6	600.4	132.80	610.4	132.58	609.4
50	525.2	514.8	132.87	518.1	132.17	515.7
55	525.2	584.1	592.7	132.67	611.2	130.69	601.1
		19 ^h .			23 ^h .			3 ^h .			7 ^h .	
0	525.3	512.4	132.67	520.6	130.70	519.0	600.7
5	525.3	588.9	594.1	132.82	609.0	130.98	600.7
10	521.5	512.6	132.78	520.1	131.47	523.4
15	521.5	589.9	596.9	132.93	609.8	131.18	601.8
20	519.2	513.6	132.60	517.8	130.12	514.0
25	519.2	592.1	594.2	132.45	606.3	129.12	603.5
30	517.8	514.3	132.20	517.5	129.52	518.1
35	517.8	593.7	593.2	132.24	604.9	129.67	603.5
40	516.4	513.5	131.85	518.1	130.35	520.3
45	516.4	594.5	593.4	131.95	604.4	130.98	601.5
50	515.5	510.8	131.85	519.2	131.40	521.6
55	515.5	599.6	598.1	131.57	608.4	131.67	599.2
		20 ^h .			0 ^h .			4 ^h .			8 ^h .	
0	509.2	506.1	131.40	519.5	132.07	519.6	599.0
5	509.2	601.6	601.2	131.30	613.4	131.85	599.0
10	507.0	513.5	131.33	519.5	131.58	520.2
15	507.0	605.0	598.9	131.37	618.5	131.73	598.9
20	506.3	511.0	131.02	520.7	131.57	518.3
25	506.3	606.9	602.0	131.25	617.7	131.38	593.3
30	506.3	511.0	131.13	519.3	131.02	519.5
35	506.3	606.2	599.6	131.15	616.9	131.05	591.4
40	514.5	510.2	131.20	520.2	131.02	520.3
45	514.5	604.0	599.9	131.47	613.6	131.02	591.2
50	518.2	507.8	131.24	519.4	130.96	522.2
55	518.2	606.5	605.6	131.40	612.6	129.95	589.3
		21 ^h .			1 ^h .			5 ^h .			9 ^h .	
0	522.0	510.2	131.50	519.8	127.54	517.0	588.9
5	522.0	603.0	606.5	131.38	608.2	125.23	588.9
10	518.2	513.0	131.22	519.8	124.82	526.6
15	518.2	602.3	607.2	131.17	609.3	126.50	590.5
20	518.4	516.2	131.30	519.7	127.63	520.4
25	518.4	601.3	612.5	131.05	609.6	127.00	593.9
30	515.9	518.6	131.05	519.2	127.08	520.6
35	515.9	599.2	612.1	131.45	609.9	127.00	599.1
40	516.9	518.9	131.65	518.6	127.57	521.7
45	516.9	600.9	611.7	131.77	613.4	127.67	598.5
50	516.4	518.6	132.77	518.1	128.49	520.0
55	516.4	604.0	610.9	132.93	614.0	128.49	601.8

Hour,	18	19	20	21	22	23	0	1	2	3	4	5	6	7	8	9	10
BIFILAR THERMOMETER,	48.5	49.8	49.8	49.9	49.4	48.7	48.4	47.9	47.6	48.5	49.5	50.1	50.6	51.6	52.1	52.6	53.1 ?
BALANCE THERMOMETER,	46.5	47.3	47.8	47.8	47.8	47.5	47.3	47.1	46.9	47.4	48.5	49.4	50.1	50.6	50.8	51.2	51.6 ?

Dec. 23^d 0^h. See note on the Declinometer, page 29.

Göttingen Mean Time of Declination Observation.	JANUARY 19, 20.											
	DECLINATION.	BIFILAR Corrected.	BALANCE Corrected.	DECLINATION.	BIFILAR Corrected.	BALANCE Corrected.	DECLINATION.	BIFILAR Corrected.	BALANCE Corrected.	DECLINATION.	BIFILAR Corrected.	BALANCE Corrected.
	Min.	Sec. Div.	Mic. Div.	Min.	Sec. Div.	Mic. Div.	Min.	Sec. Div.	Mic. Div.	Min.	Sec. Div.	Mic. Div.
	10 ^h .			14 ^h .			18 ^h .			22 ^h .		
0	123-98	519-1	958-1	126-77	520-4	943-6	127-90	523-3	948-1	129-30	512-0	944-5
6	123-45	520-4	959-5	127-63	521-2	944-2	128-03	523-1	945-3	129-80	512-3	942-9
12	123-25	518-9	961-1	127-65	520-6	944-1	127-97	521-3	948-7	130-22	512-7	942-6
18	123-42	517-8	958-9	127-45	519-4	944-8	127-97	519-9	129-78	512-7	944-4
24	123-70	516-8	960-5	127-57	519-7	943-9	127-27	520-7	944-8	130-13	512-2	947-4
30	123-58	517-9	958-7	127-70	519-9	945-4	127-27	521-7	945-4	130-09	512-1	946-7
36	123-17	517-5	958-2	128-01	519-9	946-7	128-80	521-7	946-9	131-15	513-2	950-2
42	519-2	958-0	128-01	520-0	945-9	127-27	520-1	942-9	513-4	951-5
48	123-73	517-5	958-4	127-63	520-0	946-4	126-97	523-9	942-7	132-37	512-6	954-4
54	125-48	516-6	959-1	127-50	520-8	947-4	125-79	523-2	943-0	132-93	512-3	955-5
	11 ^h .			15 ^h .			19 ^h .			23 ^h .		
0	125-92	515-0	959-9	127-67	522-2	948-7	125-63	525-6	943-7	132-44	512-0	957-5
6	125-90	513-8	957-2	127-78	520-7	949-3	126-19	523-7	940-7	132-98	513-1	957-9
12	125-05	515-0	956-0	127-92	520-3	949-2	126-30	524-0	941-9	133-13	512-2	957-6
18	125-35	517-0	962-9	127-30	519-1	947-2	126-82	523-8	942-4	133-11	512-3	958-4
24	126-28	515-2	962-1	126-40	519-7	947-3	127-55	521-3	941-7	133-30	513-0	956-9
30	125-48	514-6	958-3	126-10	519-8	945-4	125-79	524-2	938-1	133-67	512-7	956-2
36	124-07	523-5	952-0	125-65	519-5	946-8	126-72	524-3	940-2	133-67	512-9	957-4
42	126-48	520-6	950-3	125-52	518-9	947-5	126-62	523-3	940-8	133-80	513-2	956-0
48	126-40	527-4	944-2	125-60	517-7	949-0	126-59	524-2	938-2	134-27	513-5	955-2
54	128-17	521-0	943-7	126-68	516-3	949-1	126-77	524-5	940-7	134-31	514-1	954-8
	12 ^h .			16 ^h .			20 ^h .			0 ^h .		
0	128-25	516-8	942-6	126-82	514-8	950-9	128-65	522-1	941-0	134-47	514-0	956-8
6	131-47	517-2	939-4	127-81	514-4	953-3	129-27	522-2	941-9	134-37	514-8	956-6
12	134-13	514-2	934-6	128-35	515-2	954-0	129-65	522-3	942-6	134-33	515-3	958-2
18	134-92	514-4	928-5	128-52	515-5	953-8	129-65	521-6	941-1	134-44	515-6	958-4
24	134-57	519-9	919-2	129-37	515-7	955-1	129-43	522-2	939-3	134-92	516-1	958-5
30	132-78	528-8	911-2	130-38	515-9	953-2	129-12	520-6	941-8	135-25	516-9	960-3
36	131-62	529-0	907-5	130-80	515-3	952-8	129-30	518-0	942-3	135-72	518-1	962-4
42	130-55	527-0	908-1	130-35	515-0	951-1	129-18	518-4	943-5	517-9	962-6
48	129-58	525-0	909-1	129-28	515-4	948-4	129-23	517-5	942-9	135-15	518-0	964-4
54	129-49	523-2	913-5	127-95	515-7	947-3	129-21	517-9	941-8	135-02	519-5	964-0
	13 ^h .			17 ^h .			21 ^h .			1 ^h .		
0	129-92	521-8	918-2	127-32	516-0	948-5	129-15	518-7	943-3	135-28	519-5	963-1
6	128-98	520-1	918-6	127-01	517-1	949-2	128-70	515-9	943-3	135-60	520-7	960-9
12	127-48	520-1	919-9	126-82	517-0	949-9	129-23	516-1	945-4	135-73	521-4	959-1
18	126-28	519-9	919-4	127-10	517-9	951-3	128-78	514-3	944-6	135-32	521-5	956-8
24	125-60	521-0	922-1	127-47	517-8	952-5	128-94	515-2	944-9	135-08	521-5	959-4
30	125-68	519-5	924-6	127-87	519-2	953-8	128-37	515-2	945-7	135-13	522-0	952-1
36	125-66	518-6	925-9	128-43	520-4	955-1	128-97	516-0	947-9	135-17	522-7	951-1
42	125-75	518-2	937-6	129-03	520-2	955-1	128-98	515-0	945-6	136-05	522-7	948-6
48	125-62	519-2	939-5	128-92	520-7	953-0	129-23	515-5	945-6	135-95	522-4	948-6
54	126-26	519-2	941-4	128-60	522-3	951-4	129-52	513-5	944-9	136-25	523-5	947-5

Hour,	10	11	12	13	14	15	16	17	18	19	20	21	22	23	0	1
BIFILAR THERMOMETER, .	55-9	55-6	55-6	55-6	56-8	56-8	54-9	54-6	55-8	57-0	57-8	56-7	54-6	53-5	53-6	55-6
BALANCE THERMOMETER, .	56-6	56-6	56-1	56-1	58-0	57-3	55-9	56-5	57-5	58-3	59-4	57-3	56-5	55-3	54-6	57-7

During the Terms of 1842, the Bifilar was observed 2^m, and the Balance 4^m, after the corresponding minutes of Declination observation. January 20^d 6^h, 1842. Discovered some of the fibres of the Declination thread broken and caught on the copper ring; the fibres were detached from the ring, but the thread broke away fibre by fibre during the remainder of the term. The observations before 6^h are corrected by minus 13' in order to make the readings nearly as on other days, the difference being due to torsion force. These observations are given here; they are not however considered of much, if of any value, as the fibres were probably breaking throughout the whole term.

Göttingen Mean Time of Declination Observation.	JANUARY 19, 20.						FEBRUARY 25, 26.										
	DECLINATION.	BIFILAR Corrected.	BALANCE Corrected.	DECLINATION.	BIFILAR Corrected.	BALANCE Corrected.	DECLINATION.	BIFILAR Corrected.	BALANCE Corrected.	DECLINATION.	BIFILAR Corrected.	BALANCE Corrected.					
	Min.	Sec. Div.	Mic. Div.	'	Sec. Div.	Mic. Div.	'	Sec. Div.	Mic. Div.	'	Sec. Div.	Mic. Div.					
	2 ^h .			6 ^h .			10 ^h .			14 ^h .							
0	136-28	524-9	945-8	525-7	952-3	122-42	524-3	862-1	132-25	522-6	869-7					
6	136-42	525-3	944-1	525-4	952-2	125-99	518-4	869-0	132-82	523-7	869-2					
12	136-53	525-7	943-4	525-6	953-5	128-85	517-6	879-7	133-64	521-5	867-8					
18	136-45	525-3	943-4	525-2	953-6	131-09	516-0	884-2	134-15	521-7	866-7					
24	136-53	525-4	942-5	524-5	956-4	131-65	515-7	883-8	133-82	522-9	863-8					
30	136-33	525-6	942-9	523-6	956-9	131-16	519-3	134-40	521-0	864-0					
36	136-15	525-8	941-8	523-1	957-2	131-72	522-9	878-0	133-67	523-5	862-7					
42	136-15	526-2	941-7	523-1	957-7	131-90	524-5	878-4	134-70	523-6	862-9					
48	136-05	526-6	943-0	524-0	957-5	132-33	524-8	879-2	134-72	520-9	861-1					
54	135-85	526-6	945-0	524-3	957-3	133-08	523-9	877-0	134-33	523-9	861-1					
	3 ^h .			7 ^h .			11 ^h .			15 ^h .							
0	135-70	527-2	944-0	523-9	956-9	133-28	522-1	876-1	135-60	523-9	861-7					
6	135-72	527-4	944-4	523-8	956-5	132-88	522-8	875-9	135-33	522-9	860-4					
12	135-75	527-4	943-4	523-6	958-6	133-00	521-0	877-6	135-02	525-7	861-1					
18	135-68	526-8	944-0	524-1	958-0	132-44	523-1	876-2	135-22	526-5	861-2					
24	135-68	526-7	941-0	524-7	958-3	131-92	520-4	878-2	134-90	525-8	859-6					
30	135-39	525-9	943-0	525-0	958-0	131-00	518-8	879-2	133-53	526-9	858-6					
36	135-30	526-6	942-9	525-0	957-8	131-32	525-0	878-3	132-58	525-4	858-9					
42	135-33	526-7	951-2	524-1	959-5	131-63	522-8	131-65	523-6	861-2					
48	135-15	526-3	951-3	523-6	959-8	131-35	526-0	879-6	131-16	523-1	863-0					
54	135-10	525-5	952-1	523-3	961-4	131-22	521-1	882-7	131-98	521-2	863-4					
	4 ^h .			8 ^h .			12 ^h .			16 ^h .							
0	138-20	526-9	953-6	522-3	962-4	131-27	519-7	879-9	131-20	521-1	864-4					
6	138-72	526-5	953-7	520-9	965-3	130-42	520-8	879-9	131-70	521-2	866-3					
12	138-85	526-1	953-3	521-7	966-2	130-00	521-1	879-2	131-69	519-7	867-1					
18	138-89	526-8	954-1	522-1	966-0	129-65	519-7	881-1	131-62	522-0	865-8					
24	138-83	526-8	955-4	522-9	965-8	129-30	520-9	879-4	131-76	520-6	866-2					
30	138-82	525-6	954-9	519-9	964-4	129-50	522-0	879-1	131-69	521-5	866-1					
36	138-85	525-6	954-6	517-8	966-6	129-55	520-9	881-0	131-90	522-2	864-3					
42	138-56	525-6	954-5	517-8	966-3	129-52	519-6	882-1	132-44	522-4	863-6					
48	138-60	525-8	955-3	516-9	968-6	129-62	519-5	881-4	132-33	521-6	863-6					
54	138-53	525-4	955-5	519-1	968-4	129-78	522-9	881-7	132-50	524-5	863-4					
	5 ^h .			9 ^h .			13 ^h .			17 ^h .							
0	138-43	525-6	954-9	519-3	968-1	129-89	521-9	883-7	132-25	522-6	863-8					
6	138-37	525-7	955-9	519-7	967-9	130-98	520-4	886-3	132-40	521-7	863-6					
12	137-65	525-9	955-7	519-5	969-2	131-65	519-8	884-6	132-50	522-7	862-8					
18	137-63	526-5	955-1	520-6	968-6	132-67	522-4	883-8	132-82	520-3	864-2					
21	137-77	526-8	958-4	520-2	969-1	132-20	522-3	882-0	132-85	522-3	863-3					
30	137-77	526-4	959-0	519-9	968-2	133-25	523-2	880-4	132-64	522-2	864-1					
36	138-03	526-3	959-1	519-5	970-1	132-40	521-2	880-0	132-35	522-3	863-6					
42	137-95	525-8	958-1	519-0	970-6	133-04	522-1	877-4	132-05	522-3	866-1					
48	138-03	525-4	958-1	519-2	970-2	132-95	521-6	873-2	132-27	522-7	865-1					
54	138-01	526-1	958-0	517-6	971-9	132-67	522-0	870-8	132-28	523-3					
Hour,	2	3	4	5	6	7	8	9	10	10	11	12	13	14	15	16	17
BIFILAR THERMOMETER,	58-8	60-1	60-4	59-6	58-7	58-4	57-6	57-2	56-8	52-0	52-6	52-1	51-6	52-2	52-5	52-9	53-3
BALANCE THERMOMETER,	60-9	61-6	62-2	61-2	60-2	59-9	59-2	58-9	58-6	52-1	52-6	53-1	52-2	53-9	54-1	54-6	55-1

Jan. 19^d, 20^d. See note on the Declinometer, page 31.

Göttingen Mean Time of Declination Observation.	FEBRUARY 25, 26.											
	DECLINA- TION.	BIFILAR Corrected.	BALANCE Corrected.	DECLINA- TION.	BIFILAR Corrected.	BALANCE Corrected.	DECLINA- TION.	BIFILAR Corrected.	BALANCE Corrected.	DECLINA- TION.	BIFILAR Corrected.	BALANCE Corrected.
	Min.	Sc. Div.	Mic. Div.	'	Sc. Div.	Mic. Div.	'	Sc. Div.	Mic. Div.	'	Sc. Div.	Mic. Div.
	18 ^h .			22 ^h .			2 ^h .			6 ^h .		
0	132.47	523.3	874.0	134.27	516.2	888.9	136.30	525.6	875.1	132.84	526.6	864.0
6	132.98	522.8	874.7	134.88	515.6	891.8	136.33	526.5	875.1	132.84	526.0	859.6
12	132.98	522.7	874.9	134.11	515.3	893.3	136.28	527.2	875.4	132.93	524.1	864.4
18	133.18	521.9	877.7	133.38	514.7	899.7	136.82	528.8	875.8	132.38	522.9	860.8
24	132.98	522.7	877.2	133.31	513.7	884.1	137.02	529.2	874.7	132.00	524.1	865.3
30	132.75	523.8	877.1	133.30	514.2	885.8	136.73	528.9	874.2	131.76	525.5	866.5
36	132.80	523.8	876.0	133.60	513.4	888.1	136.26	528.3	371.8	130.56	526.0	868.5
42	132.64	523.9	875.8	133.68	513.3	886.4	136.35	528.5	869.7	131.42	523.4	867.8
48	132.55	524.3	874.4	133.30	513.8	885.5	136.03	528.0	867.9	130.95	520.0	867.9
54	132.55	524.7	872.4	134.18	514.0	885.7	135.97	529.0	866.2	129.85	520.0	870.4
	19 ^h .			23 ^h .			3 ^h .			7 ^h .		
0	131.87	524.9	871.2	134.58	515.1	882.0	135.60	527.4	864.1	128.54	518.3	868.0
6	131.95	527.2	867.8	134.50	882.0	134.88	527.0	862.5	126.52	522.9	867.7
12	131.93	529.9	866.6	134.15	516.1	881.0	134.50	525.2	859.3	126.19	523.8	869.5
18	131.96	526.9	863.6	134.58	517.0	884.2	134.68	529.9	857.7	127.63	525.5	872.3
24	131.62	527.8	860.9	135.33	515.2	884.0	134.60	528.6	857.6	129.73	526.5	871.9
30	131.45	527.5	862.3	134.85	514.9	882.8	134.72	529.3	857.9	130.30	526.2	871.7
36	131.69	525.2	864.7	135.66	513.8	879.6	134.73	530.6	859.6	131.32	525.5	871.5
42	131.55	524.5	863.4	136.12	516.0	882.3	134.82	530.9	860.5	132.27	525.3	869.5
48	131.82	524.1	861.1	135.79	514.0	883.2	134.24	528.8	861.8	132.77	525.5	869.1
54	132.02	522.7	861.2	135.52	513.8	881.9	134.20	528.5	132.05	524.9	865.1
	20 ^h .			0 ^h .			4 ^h .			8 ^h .		
0	131.30	524.2	859.8	135.22	514.2	883.6	133.97	528.1	865.1	131.65	525.9	862.3
6	131.49	525.1	857.1	135.66	512.5	890.9	133.80	528.1	865.2	132.35	526.4	863.9
12	132.25	526.9	857.8	135.52	513.9	892.5	133.87	528.8	864.4	133.11	526.7	863.2
18	133.10	525.1	860.8	135.95	513.0	898.4	133.77	530.3	866.2	133.37	525.2	863.5
24	133.35	524.0	861.8	135.77	514.3	900.4	133.70	529.2	865.1	133.37	526.1	863.5
30	133.57	522.5	863.6	135.83	515.4	899.1	133.60	528.9	863.5	133.02	525.7	864.2
36	132.62	521.9	863.0	136.08	517.0	133.50	530.7	863.3	132.93	526.2	862.3
42	132.65	523.2	863.7	135.82	519.1	894.6	133.37	529.0	861.0	132.97	525.2	865.8
48	132.40	522.9	865.2	136.35	518.8	894.4	133.51	530.3	860.1	132.93	525.1	864.4
54	132.42	526.0	869.1	136.17	520.7	893.5	133.50	532.2	859.5	132.87	524.6	863.4
	21 ^h .			1 ^h .			5 ^h .			9 ^h .		
0	133.30	525.9	870.5	519.4	892.3	133.57	532.2	858.8	132.87	524.5	864.2
6	133.58	524.5	872.0	136.30	522.0	890.4	133.42	526.2	858.0	132.80	524.0	864.4
12	133.51	525.5	873.1	136.30	519.2	892.0	133.42	526.7	856.7	132.53	523.5	864.7
18	134.92	521.5	870.1	136.50	519.8	892.8	132.90	530.8	857.0	132.67	522.6	866.5
24	135.13	520.7	870.0	136.73	520.0	890.4	133.24	531.9	861.0	132.82	524.0	866.4
30	134.63	519.4	882.5	136.53	520.0	890.2	133.00	527.4	861.1	132.85	527.1	864.3
36	134.53	519.5	885.9	136.48	521.5	885.6	133.00	527.7	861.8	132.13	522.8	863.0
42	134.57	518.4	887.3	136.53	523.9	883.3	133.17	528.6	861.0	132.33	521.6	870.2
48	134.20	519.0	888.0	136.53	523.3	880.5	133.00	527.2	863.5	132.24	522.3	876.8
54	135.32	516.7	890.8	136.65	523.4	879.5	132.93	526.9	864.4	132.33	522.8	874.9

Hour,	18	19	20	21	22	23	0	1	2	3	4	5	6	7	8	9	10
BIFILAR THERMOMETER,	52.8	52.9	53.6	53.3	52.6	51.4	50.6	52.2	54.2	56.6	57.3	58.3	58.6	57.7	56.7	55.6	54.6
BALANCE THERMOMETER,	54.9	55.2	55.9	55.2	54.1	53.4	52.1	54.1	56.1	58.2	59.1	59.9	59.7	58.7	58.2	57.2	56.2

Göttingen Mean Time of Declination Observation.	MARCH 23, 24.															
	DECLINA- TION.	BIFILAR Corrected.	BALANCE Corrected.	DECLINA- TION.	BIFILAR Corrected.	BALANCE Corrected.	DECLINA- TION.	BIFILAR Corrected.	BALANCE Corrected.	DECLINA- TION.	BIFILAR Corrected.	BALANCE Corrected.				
	Min.	Sc. Div.	Mic. Div.	'	Sc. Div.	Mic. Div.	'	Sc. Div.	Mic. Div.	'	Sc. Div.	Mic. Div.				
	10 ^h .			14 ^h .			18 ^h .			22 ^h .						
0	112.64	529.1	941.9	121.50	527.2	673.0	126.90	531.6	823.3	129.60	511.3	865.7				
6	112.87	531.7	931.4	121.53	527.5	686.5	126.68	528.9	822.4	131.32	506.8	867.9				
12	113.63	535.0	918.5	121.68	526.7	696.9	126.62	531.0	831.6	131.43	502.3	867.4				
18	114.11	532.9	917.1	121.95	525.6	707.6	126.77	528.8	830.7	131.22	497.0	867.7				
24	113.88	534.4	916.0	121.85	523.7	717.4	127.23	529.4	831.1	129.96	501.1	868.7				
30	115.02	532.9	893.3	121.95	525.3	728.8	126.05	532.1	829.4	132.33	503.9	870.2				
36	115.72	534.6	885.1	122.07	524.3	737.5	126.87	532.9	830.7	133.64	506.6	870.2				
42	115.57	535.3	878.4	121.43	527.0	748.0	127.84	531.9	830.9	132.73	868.7				
48	117.23	531.4	871.6	122.87	525.3	762.9	125.85	538.3	827.9	131.02	502.4	868.5				
54	116.90	529.9	870.6	122.90	524.8	769.4	126.82	537.1	829.0	131.09	502.3	866.8				
	11 ^h .			15 ^h .			19 ^h .			23 ^h .						
0	117.70	529.5	865.8	123.44	526.3	777.3	126.87	536.0	827.3	130.13	503.9	866.4				
6	118.90	528.3	863.9	124.05	528.6	783.4	125.59	537.3	824.8	132.20	505.8	869.2				
12	119.85	528.7	860.0	125.48	523.4	790.8	126.28	537.9	826.6	131.50	508.9	871.5				
18	120.32	530.3	855.9	124.77	526.5	796.3	127.37	534.6	828.1	132.57	511.5	869.0				
24	122.02	527.3	848.0	124.37	527.5	799.2	126.25	534.2	831.1	133.27	512.1	867.6				
30	121.12	524.9	836.0	124.52	529.7	800.5	128.28	533.3	834.1	133.45	515.8	866.2				
36	121.05	529.4	826.2	124.52	527.1	804.0	125.97	530.1	836.7	133.65	515.1	865.7				
42	120.82	532.4	824.9	124.24	530.6	805.6	125.48	529.5	838.2	133.00	515.5	865.0				
48	119.83	532.9	820.9	124.05	527.1	807.0	126.72	527.6	842.3	132.33	518.7	863.5				
54	120.72	531.1	808.6	124.08	523.9	813.8	126.32	526.3	845.0	131.80	521.0	863.2				
	12 ^h .			16 ^h .			20 ^h .			0 ^h .						
0	120.12	528.8	795.7	122.80	530.3	812.8	125.45	527.8	849.9	131.93	523.4	858.7				
6	122.65	525.5	786.8	124.82	529.3	815.5	124.13	519.9	849.0	133.05	523.7	857.5				
12	125.50	525.9	769.3	124.72	529.2	815.7	125.33	524.9	850.0	133.13	523.2	858.4				
18	129.96	527.6	739.8	124.77	529.5	816.8	127.07	526.5	851.8	133.38	524.6	855.7				
24	133.33	514.6	682.6	124.82	529.8	818.8	125.88	525.0	853.0	134.15	524.4	858.5				
30	134.35	507.9	623.5	125.75	526.8	820.5	125.59	520.6	852.6	134.15	523.8	856.5				
36	129.03	521.0	586.3	125.23	527.7	822.6	126.48	530.4	857.4	134.22	524.3	857.5				
42	129.69	531.7	583.3	125.82	528.3	822.9	122.00	522.2	854.3	134.05	521.8				
48	124.10	506.4	544.9	126.75	526.8	822.9	124.40	524.7	852.9	134.27	523.7	855.6				
54	121.90	483.9	521.2	126.72	525.8	826.2	123.45	524.4	851.4	134.66	523.7	856.0				
	13 ^h .			17 ^h .			21 ^h .			1 ^h .						
0	125.03	477.7	532.0	127.35	526.3	828.1	127.77	527.1	849.0	134.50	524.1	856.3				
6	135.79	511.6	605.1	127.70	523.7	828.3	124.27	525.5	849.1	134.70	523.0	850.8				
12	140.38	531.1	575.7	128.25	530.2	826.8	124.48	526.0	846.3	134.88	524.3	849.6				
18	131.02	534.6	550.3	128.92	523.0	827.3	126.05	523.2	846.4	134.79	524.3	850.4				
24	124.75	531.9	556.9	128.74	526.4	827.3	128.10	521.9	857.1	134.93	524.9	849.9				
30	120.62	523.7	584.2	127.88	530.9	825.8	126.82	522.2	856.0	134.99	525.8	849.6				
36	119.76	519.8	611.5	127.97	528.4	824.5	126.46	520.5	859.2	134.75	526.0	849.6				
42	120.89	519.9	631.1	126.45	532.0	826.4	125.62	519.3	860.2	134.73	526.2	848.1				
48	121.49	526.4	642.0	126.87	531.4	826.6	127.35	516.0	861.0	134.66	525.9	850.3				
54	121.47	528.9	647.2	127.47	528.8	825.7	128.21	512.4	864.1	134.27	527.7	849.0				
HOOR,	10	11	12	13	14	15	16	17	18	19	20	21	22	23	0	1
BIFILAR THERMOMETER, . .	54.6	55.6	55.9	56.4	56.6	56.7	56.6	56.5	56.5	56.9	56.7	57.6	58.6	59.4	60.1	60.2
BALANCE THERMOMETER, . .	55.1	56.7	57.2	57.7	58.3	58.3	58.2	58.4	58.5	58.9	58.2	59.2	60.0	60.5	61.0	61.0

Göttingen Mean Time of Declination Observation.	MARCH 23, 24.						APRIL 20, 21.					
	DECLINA- TION.	BIFILAR Corrected.	BALANCE Corrected.	DECLINA- TION.	BIFILAR Corrected.	BALANCE Corrected.	DECLINA- TION.	BIFILAR Corrected.	BALANCE Corrected.	DECLINA- TION.	BIFILAR Corrected.	BALANCE Corrected.
	Min.	Sc. Div.	Mic. Div.	'	Sc. Div.	Mic. Div.	'	Sc. Div.	Mic. Div.	'	Sc. Div.	Mic. Div.
	2 ^h .			6 ^h .			10 ^h .			14 ^h .		
0	134-30	529.1	848.2	124-57	536.7	863.9	131-58	532.0	872.4	128-08	529.1	800.9
6	133-87	526.9	848.5	123-97	542.3	864.5	131-49	532.0	870.8	129-27	532.6	799.7
12	134-08	528.8	848.3	123-24	543.1	865.7	131-76	532.3	870.9	130-40	532.5	790.5
18	134-22	529.4	848.3	123-65	540.5	870.0	132-33	535.5	863.9	125-72	530.8	792.4
24	133-90	529.3	847.0	124-39	533.1	872.2	131-65	546.4	854.2	123-60	529.0	799.6
30	133-98	527.6	846.3	125-22	532.4	872.0	133-02	543.8	852.5	123-50	527.8	805.8
36	133-75	527.7	845.8	125-62	530.9	869.9	133-08	538.5	851.2	123-60	530.1	808.7
42	133-57	528.9	845.6	125-62	529.4	868.5	132-97	532.8	849.8	126-55	530.2	808.0
48	133-17	527.6	844.8	125-40	529.3	867.9	132-37	529.1	853.1	127-95	526.7	800.5
54	132-97	528.3	843.5	124-13	532.9	867.9	132-15	528.4	849.8	126-73	527.1	790.6
	3 ^h .			7 ^h .			11 ^h .			15 ^h .		
0	132-84	529.7	842.6	124-27	533.8	869.1	131-73	529.1	856.2	125-32	526.2	784.1
6	132-53	528.1	845.2	124-85	532.6	868.9	131-82	532.0	856.0	124-73	522.5	784.3
12	132-44	527.0	844.3	124-95	531.2	869.0	131-73	531.1	858.6	124-66	518.2	776.0
18	132-08	529.2	843.7	125-39	531.4	866.9	131-65	529.1	123-31	511.8	773.8
24	131-89	528.2	843.8	124-82	534.2	864.9	133-88	533.6	861.5	122-38	505.8	769.5
30	131-65	529.7	844.1	124-88	538.8	862.9	135-39	537.1	854.9	123-31	503.4	766.0
36	131-60	530.3	844.8	124-85	539.5	860.6	135-83	539.5	849.4	125-53	497.6	755.0
42	131-29	529.7	844.9	124-80	537.7	859.4	135-06	541.1	840.4	125-68	496.2	733.4
48	130-78	529.0	844.5	124-68	535.4	859.4	134-57	542.6	835.0	124-92	497.6	713.3
54	130-82	528.6	844.3	124-43	535.3	859.1	134-02	540.3	833.2	126-25	476.7	718.2
	4 ^h .			8 ^h .			12 ^h .			16 ^h .		
0	131-05	536.4	844.4	123-93	533.5	860.9	132-84	541.9	829.8	131-53	470.3	714.9
6	130-12	528.9	844.6	123-84	527.9	861.7	132-84	541.1	827.9	139-82	472.8	734.5
12	130-62	535.7	844.8	120-72	530.7	862.7	132-22	542.7	822.5	146-82	502.0	728.2
18	130-13	531.6	846.6	117-15	526.0	858.7	131-73	543.1	818.3	145-65	712.8
24	129-93	532.0	846.8	113-80	535.9	851.5	130-96	542.4	814.4	143-45	508.6	705.7
30	129-73	532.1	847.7	112-93	549.1	827.5	129-95	540.2	812.7	142.74	506.2	709.5
36	129-93	532.8	848.2	109-38	575.1	814.1	129-67	534.9	814.2	141-57	508.4	708.7
42	124-93	534.7	847.9	112-87	558.4	801.7	128-14	527.1	818.9	139-78	517.3	717.1
48	129-08	532.2	849.4	116-30	556.5	795.1	127-32	525.2	822.9	137-92	516.5	718.5
54	130-20	524.9	849.7	123-44	543.8	797.3	128-38	525.0	828.9	518.0	717.2
	5 ^h .			9 ^h .			13 ^h .			17 ^h .		
0	130-43	534.1	852.0	123-60	530.1	795.3	129-69	519.8	832.1	135-32	517.2	722.5
6	129-98	526.4	854.7	122-30	532.7	793.7	130-35	522.9	834.1	133-37	519.2	727.1
12	128-94	519.7	861.1	120-85	539.3	790.8	131-65	522.5	835.4	131-98	521.4	737.4
18	128-25	518.8	862.1	122-27	541.5	788.6	136-02	533.7	827.5	131-22	525.3	745.4
24	127-05	517.7	864.5	124-27	536.3	787.6	137-48	535.0	814.2	131-16	526.3	757.9
30	125-33	525.8	866.0	123-68	530.9	787.4	136-63	530.8	805.1	131-45	524.0	761.0
36	125-30	531.1	864.5	122-08	527.0	787.6	135-33	527.7	796.6	130-87	526.1	763.9
42	125-28	530.0	865.4	119-58	532.8	787.5	132-45	528.5	794.2	130-83	525.0	769.0
48	125-48	532.6	864.7	120-75	536.2	786.2	130-78	528.7	794.3	129-27	529.4	776.4
54	125-68	533.0	864.8	124-30	535.2	796.3	128-94	527.7	799.1	129-28	532.5	781.2

Hour,	2	3	4	5	6	7	8	9	10	10	11	12	13	14	15	16	17
BIFILAR THERMOMETER,	60.4	60.4	60.9	61.9	63.1	63.4	63.0	62.4	61.8	59.6	59.6	59.1	59.1	59.0	59.4	59.2	58.8
BALANCE THERMOMETER,	61.1	61.3	61.9	62.9	63.7	63.9	64.2	64.2	64.2	58.7	59.2	59.2	59.2	59.5	60.1	60.2	59.7

Göttingen Mean Time of Declination Observation.	APRIL, 20, 21.																
	DECLINA- TION.	BIFILAR Corrected.	BALANCE Corrected.	DECLINA- TION.	BIFILAR Corrected.	BALANCE Corrected.	DECLINA- TION.	BIFILAR Corrected.	BALANCE Corrected.	DECLINA- TION.	BIFILAR Corrected.	BALANCE Corrected.					
	Min.	Sc. Div.	Mic. Div.	Sc. Div.	Mic. Div.	Sc. Div.	Sc. Div.	Mic. Div.	Sc. Div.	Mic. Div.	Sc. Div.	Mic. Div.					
	18 ^h .			22 ^h .			2 ^h .			6 ^h .							
0	128-87	534-2	790-1	133-78	516-7	858-1	140-33	526-9	848-5	133-64	550-0	913-2					
6	128-78	535-8	795-6	135-32	512-8	861-4	140-27	530-4	847-8	133-67	546-2	914-8					
12	128-27	535-6	800-7	135-22	513-4	860-5	140-13	530-3	848-5	132-60	542-7	916-6					
18	127-88	535-2	809-3	134-44	515-7	859-2	139-72	532-8	845-8	132-84	538-7	920-2					
24	127-81	532-6	816-2	135-23	516-1	863-6	140-18	537-5	847-6	131-63	544-1	922-0					
30	127-20	528-5	822-4	136-83	514-4	864-4	140-38	542-7	849-7	131-09	544-5	924-8					
36	127-21	527-8	828-6	136-62	510-4	863-0	140-70	543-9	852-2	131-05	546-2	924-7					
42	127-10	527-2	834-2	137-18	511-0	864-1	140-56	544-8	854-9	131-13	545-8	925-2					
48	128-12	526-3	840-1	136-93	510-9	863-5	140-40	544-6	858-4	132-97	539-0	928-1					
54	127-35	529-0	842-1	137-60	510-6	860-8	140-32	546-3	861-0	132-98	534-9	927-9					
	19 ^h .			23 ^h .			3 ^h .			7 ^h .							
0	126-87	532-0	843-4	137-70	508-7	861-6	139-80	543-9	864-9	131-70	538-8	925-5					
6	127-23	529-8	845-4	137-58	505-0	868-4	139-58	535-6	868-6	133-78	535-3	928-3					
12	127-72	527-4	847-7	138-37	501-4	868-6	139-30	530-0	873-1	133-20	536-0	923-1					
18	129-56	527-4	850-3	138-95	505-9	863-9	140-30	532-3	875-5	132-88	534-1	920-8					
24	130-43	525-3	852-0	139-12	508-4	860-6	141-58	537-2	883-0	132-40	535-7	916-7					
30	132-91	530-5	853-9	139-42	507-9	858-7	141-73	541-3	886-9	132-93	537-9	911-9					
36	133-25	524-3	856-5	139-32	504-1	862-5	139-29	540-3	897-9	133-47	539-9	906-1					
42	134-65	521-9	858-4	140-13	501-7	863-5	136-32	535-1	904-3	133-60	542-5	902-6					
48	135-80	518-1	858-4	141-00	499-9	864-1	129-18	535-2	909-9	133-70	540-5	898-3					
54	134-65	515-8	859-1	141-48	503-3	858-0	127-34	546-3	915-4	133-27	539-9	896-5					
	20 ^h .			0 ^h .			4 ^h .			8 ^h .							
0	133-20	511-7	859-8	141-17	505-2	859-2	128-77	538-0	918-4	132-55	535-0	892-4					
6	130-62	505-7	859-4	141-33	508-9	855-4	130-75	532-9	921-3	132-15	535-4	892-9					
12	130-75	506-5	861-4	142-38	506-8	861-6	128-97	546-4	923-9	131-62	537-1	895-0					
18	131-69	507-1	864-1	141-27	500-7	861-7	127-57	553-9	924-7	131-13	539-7	894-7					
24	134-47	510-0	866-2	140-50	501-5	861-7	128-88	554-6	927-3	130-78	535-3	895-3					
30	135-06	511-2	868-8	141-47	501-8	858-6	131-18	554-8	926-6	129-62	534-5	890-6					
36	138-96	496-7	864-0	141-28	505-6	858-8	131-16	548-0	927-2	125-99	542-8	871-9					
42	132-37	508-9	865-3	141-05	510-5	854-7	134-68	552-6	924-0	127-23	552-0	876-8					
48	133-11	506-8	868-4	141-67	509-6	854-4	135-79	542-0	920-8	132-27	540-6	876-3					
54	134-18	508-1	140-90	516-1	850-3	136-42	533-2	919-8	132-93	534-7	870-2					
	21 ^h .			1 ^h .			5 ^h .			9 ^h .							
0	133-40	509-3	871-2	140-92	516-7	853-0	135-75	531-8	921-8	132-93	532-5	867-9					
6	133-65	510-4	869-6	140-98	523-3	851-5	134-95	524-4	925-2	132-20	533-2	865-2					
12	133-35	511-7	868-4	140-30	523-5	853-2	131-32	541-2	926-2	131-83	534-9	862-6					
18	132-70	509-4	869-0	141-42	522-1	854-7	555-5	928-4	132-37	536-0	863-8					
24	133-11	510-9	869-0	141-68	521-9	855-5	129-52	558-9	930-1	132-37	535-1	860-7					
30	132-98	513-5	868-3	140-78	521-7	851-6	127-67	554-0	926-9	132-80	536-7	859-0					
36	132-68	513-1	867-5	140-92	525-1	847-6	128-97	551-0	922-6	133-40	536-6	857-4					
42	132-58	515-7	866-9	141-51	524-1	848-7	129-27	552-0	919-8	133-67	535-2	852-8					
48	134-28	513-0	866-6	141-27	524-6	845-9	130-27	553-3	915-6	133-25	533-8	851-2					
54	133-80	514-5	865-1	140-78	525-0	845-8	132-33	551-8	912-6	132-45	531-3	853-5					
Hour,	18	19	20	21	22	23	0	1	2	3	4	5	6	7	8	9	10
BIFILAR THERMOMETER,	58-5	57-8	57-1	57-1	57-7	58-6	60-4	61-8	63-8	65-7	67-7	68-1	68-4	68-6	68-0	67-6	67-2
BALANCE THERMOMETER,	59-6	59-1	58-7	58-7	58-5	59-5	60-2	61-6	63-1	64-3	66-2	66-8	67-3	67-3	67-0	67-3	67-3

Göttingen Mean Time of Declination Observation.	MAY 27, 28.																
	DECLINA- TION.	BIFILAR Corrected.	BALANCE Corrected.	DECLINA- TION.	BIFILAR Corrected.	BALANCE Corrected.	DECLINA- TION.	BIFILAR Corrected.	BALANCE Corrected.	DECLINA- TION.	BIFILAR Corrected.	BALANCE Corrected.					
	Min.	Se. Div.	Mic. Div.	Se. Div.	Mic. Div.	Se. Div.	Se. Div.	Mic. Div.	Se. Div.	Mic. Div.	Se. Div.	Mic. Div.					
	10 ^h .			14 ^h .			18 ^h .			22 ^h .							
0	129-30	543-0	815-8	127-94	533-9	783-2	126-59	827-4	127-34	527-4	828-8					
6	129-34	542-7	812-1	127-87	534-1	785-7	126-37	536-1	839-6	127-08	527-3	826-7					
12	129-65	542-7	810-5	128-18	533-9	788-3	126-46	534-9	838-7	127-78	528-2	825-7					
18	129-65	542-7	808-3	128-57	534-8	788-0	125-13	531-9	840-6	127-47	525-7	823-1					
24	130-02	544-0	805-3	128-95	534-3	788-2	125-08	531-1	841-4	128-10	527-6	822-3					
30	129-41	542-9	805-4	128-77	534-4	790-4	125-25	531-3	845-1	128-18	526-8	822-6					
36	128-92	804-6	128-92	533-5	790-7	126-43	532-3	849-8	128-52	527-3	821-7					
42	129-20	541-8	803-2	128-48	533-4	791-8	126-37	533-3	851-6	128-97	523-3	819-2					
48	129-17	543-0	799-3	128-92	531-8	793-0	126-88	531-5	851-6	128-72	526-1	816-2					
54	129-60	546-3	797-6	129-47	532-7	796-3	126-20	529-9	851-0	129-62	525-8	814-9					
	11 ^h .			15 ^h .			19 ^h .			23 ^h .							
0	128-94	546-8	797-4	129-87	534-8	792-5	126-37	530-2	851-5	130-12	523-8	815-2					
6	543-4	800-0	130-00	534-2	788-6	125-66	530-2	851-0	130-47	524-3	808-8					
12	129-27	541-8	799-2	129-41	534-7	790-9	126-53	528-8	848-4	130-60	523-4	807-7					
18	129-10	541-3	799-0	130-33	534-6	794-4	127-43	529-1	847-2	131-40	523-4	806-2					
24	128-98	541-2	797-9	130-45	534-5	794-0	126-26	531-1	843-7	132-24	523-7	805-2					
30	128-97	540-9	798-7	130-72	535-0	792-3	126-77	532-5	845-0	133-02	525-9	806-0					
36	128-83	541-2	797-5	130-22	534-5	792-4	127-61	530-1	845-4	133-33	523-5	805-0					
42	128-94	541-6	796-6	130-12	536-2	797-1	127-37	529-9	844-1	133-50	525-6	804-9					
48	128-80	541-8	796-7	130-43	795-7	127-61	529-7	844-1	133-70	525-4	802-7					
54	128-94	542-1	795-1	130-45	535-8	797-5	126-90	527-0	843-7	133-47	803-3					
	12 ^h .			16 ^h .			20 ^h .			0 ^h .							
0	128-97	540-6	795-1	129-41	535-0	798-3	126-30	530-8	841-9	134-38	526-8	802-1					
6	540-7	795-7	129-27	534-1	801-3	126-46	531-6	840-6	134-33	526-3	801-7					
12	130-67	541-1	795-3	129-28	533-8	806-2	126-57	530-1	839-9	134-13	528-2	800-0					
18	130-10	541-2	793-7	128-54	535-5	808-8	125-95	531-0	841-5	135-02	531-4	798-4					
24	129-53	542-7	794-0	128-68	535-1	815-6	125-28	532-7	839-7	135-19	531-6	797-5					
30	129-43	542-0	786-1	128-70	535-0	816-0	125-40	532-0	841-1	134-80	531-3	795-7					
36	130-80	540-8	784-3	128-54	535-2	817-4	125-45	531-1	839-9	135-02	530-2	794-5					
42	130-75	541-4	778-4	128-75	534-4	819-0	125-20	529-7	837-0	134-99	532-0	793-4					
48	130-67	540-2	776-0	128-32	533-7	820-3	125-03	530-6	836-0	134-92	530-2	790-6					
54	130-23	541-6	774-2	128-14	534-5	824-0	125-19	531-2	835-8	134-72	529-7	792-7					
	13 ^h .			17 ^h .			21 ^h .			1 ^h .							
0	129-23	539-6	772-2	128-37	533-0	826-8	125-02	530-1	836-8	134-68	531-5	792-4					
6	128-81	540-9	770-7	127-67	534-5	829-5	125-48	530-6	836-1	135-02	534-7	790-5					
12	129-01	540-7	772-1	127-72	534-7	828-9	125-59	530-3	835-1	134-77	529-0	792-9					
18	129-28	540-9	771-1	127-87	534-4	832-6	125-50	530-6	835-6	134-83	531-0	795-7					
24	129-47	539-9	771-4	127-70	536-1	832-0	125-55	531-2	833-2	134-60	532-2	792-6					
30	129-03	539-5	771-0	129-14	535-4	832-9	125-95	530-0	833-3	134-79	530-8	791-6					
36	129-00	539-0	776-6	126-85	536-6	835-0	125-72	528-6	834-8	135-33	538-4	790-8					
42	128-43	537-2	775-8	126-22	535-8	834-7	125-95	528-5	832-3	135-05	531-1	792-1					
48	128-35	536-2	777-1	126-05	537-0	836-3	126-13	528-2	832-2	135-32	533-9	792-5					
54	128-08	534-2	776-7	126-37	538-6	837-2	126-88	527-1	825-4	135-60	538-9	793-6					
Hour,		10	11	12	13	14	15	16	17	18	19	20	21	22	23	0	1
BIFILAR THERMOMETER, .		60-8	60-3	59-7	58-9	58-1	57-6	56-6	55-8	55-8	55-0	55-8	55-9	56-9	58-1	59-3	60-7
BALANCE THERMOMETER, .		59-9	59-9	59-8	59-3	58-5	58-0	57-2	56-3	56-2	55-3	56-2	56-3	56-7	57-8	58-7	60-1

Göttingen Mean Time of Declination Observation.	MAY 27, 28.						JUNE 22, 23.										
	DECLINA- TION.	BIFILAR Corrected.	BALANCE Corrected.	DECLINA- TION.	BIFILAR Corrected.	BALANCE Corrected.	DECLINA- TION.	BIFILAR Corrected.	BALANCE Corrected.	DECLINA- TION.	BIFILAR Corrected.	BALANCE Corrected.					
	Min.	Sec. Div.	Mic. Div.	'	Sec. Div.	Mic. Div.	'	Sec. Div.	Mic. Div.	'	Sec. Div.	Mic. Div.					
	2 ^h .			6 ^h .			10 ^h .			14 ^h .							
0	135.82	539.2	794.2	130.05	546.1	825.4	127.57	554.5	792.6	132.70	554.5	737.8					
6	136.00	536.7	797.7	130.76	553.6	820.5	128.14	791.4	126.35	548.9	732.2					
12	136.19	536.7	801.2	129.87	546.8	824.4	127.94	558.3	789.0	122.97	549.5	733.5					
18	136.23	534.6	798.0	129.70	546.4	825.2	128.28	555.6	783.1	121.56	547.3	734.9					
24	136.22	535.1	799.5	129.76	547.3	826.7	127.90	554.9	777.7	122.85	548.1	731.5					
30	136.05	536.8	802.3	129.78	549.2	824.3	127.68	555.9	774.2	124.43	544.7	730.0					
36	135.92	534.8	798.7	129.52	548.6	824.3	127.70	555.1	772.8	122.53	537.4	731.3					
42	136.06	540.7	795.8	129.49	549.5	824.3	127.25	556.2	771.1	125.88	540.9	729.2					
48	135.85	540.2	798.6	129.35	550.0	824.9	126.95	552.8	769.8	127.01	538.1	720.1					
54	135.40	536.3	800.7	129.40	549.1	824.9	126.02	553.6	769.7	127.35	531.8	718.8					
	3 ^h .			7 ^h .			11 ^h .			15 ^h .							
0	135.59	534.7	807.1	129.12	549.7	825.8	126.23	551.9	768.6	125.46	535.1	715.2					
6	135.53	535.1	808.2	129.03	548.1	825.9	125.82	552.1	769.6	126.79	538.7	714.9					
12	135.59	537.3	808.6	129.10	549.1	825.7	126.08	553.1	769.9	128.38	531.9	711.8					
18	135.60	536.4	808.2	129.37	551.6	826.2	125.65	553.3	769.0	126.32	534.3	709.0					
24	135.80	541.0	805.8	129.37	548.2	826.8	125.65	552.6	768.6	126.46	539.3	706.1					
30	135.42	542.3	806.0	129.05	547.6	826.6	126.02	551.9	767.9	126.95	539.7	707.5					
36	135.23	540.5	806.3	129.20	549.0	826.4	124.95	555.7	764.7	126.40	545.4	716.0					
42	134.72	541.9	805.6	129.23	548.7	825.8	126.32	561.1	763.4	125.48	545.9	717.8					
48	134.80	545.4	802.9	129.37	552.1	823.6	124.46	554.9	763.4	127.10	547.1	732.3					
54	134.33	541.3	804.9	129.15	551.8	825.3	124.20	555.4	763.8	125.35	543.6	726.7					
	4 ^h .			8 ^h .			12 ^h .			16 ^h .							
0	134.85	545.1	801.7	129.52	550.4	826.2	124.65	552.0	765.0	128.43	536.3	731.8					
6	133.75	544.9	801.5	129.43	550.5	826.4	124.46	556.9	761.9	126.10	537.8	731.9					
12	133.18	545.4	805.1	129.35	551.1	825.3	123.77	556.4	764.7	122.04	540.2	732.3					
18	133.00	542.3	806.2	129.03	551.5	825.1	124.62	557.9	761.9	122.97	535.6	746.4					
24	133.08	546.8	805.6	129.07	551.8	826.1	125.23	560.3	761.1	124.85	527.6	746.8					
30	133.37	547.1	805.3	129.62	549.8	826.6	125.35	561.9	759.0	124.93	524.2	746.0					
36	132.20	540.4	809.0	129.65	547.6	825.6	126.55	560.2	758.4	124.80	545.6	744.2					
42	132.20	542.1	809.4	129.50	550.0	823.8	126.26	565.6	755.1	123.65	532.9	739.5					
48	131.75	540.0	811.4	129.62	552.1	818.5	128.50	568.5	751.5	124.39	530.0	739.0					
54	131.82	542.2	811.4	129.58	549.8	822.7	130.80	569.7	754.5	122.77	534.7	748.3					
	5 ^h .			9 ^h .			13 ^h .			17 ^h .							
0	131.58	543.3	811.0	129.30	550.2	824.0	133.70	562.8	753.7	125.19	537.6	751.9					
6	131.80	548.5	810.2	129.17	551.0	823.4	133.11	547.9	754.1	123.11	537.5	753.0					
12	131.47	550.5	812.4	129.65	550.4	823.1	127.15	549.7	743.0	122.50	531.0	754.6					
18	131.12	549.7	813.3	129.65	548.7	822.7	124.42	550.7	742.2	122.87	524.1	759.8					
24	130.85	548.8	814.5	129.55	547.2	824.7	123.07	555.4	743.3	124.00	531.9	759.6					
30	130.60	549.6	816.6	129.65	546.9	823.9	123.50	552.7	749.9	125.02	531.7	763.5					
36	130.27	545.2	819.5	129.62	549.6	822.0	123.24	550.5	749.9	125.28	530.2	765.2					
42	130.35	544.2	822.2	129.62	550.1	822.8	123.11	559.9	747.6	127.01	528.2	768.5					
48	130.32	545.3	824.2	129.62	551.3	824.4	125.59	560.9	747.6	128.30	522.7	772.9					
54	130.35	546.6	825.5	129.83	550.0	829.4	127.60	556.5	741.6	129.34	516.2	775.4					
Hour,	2	3	4	5	6	7	8	9	10	10	11	12	13	14	15	16	17
BIFILAR THERMOMETER,	61.3	62.2	62.7	63.0	63.5	63.7	63.7	62.9	62.0 ?	64.4	64.2	63.6	63.0	61.6	61.0	60.2	59.4
BALANCE THERMOMETER,	60.5	61.4	62.0	62.3	62.7	62.7	62.8	62.2	61.7 ?	65.2	64.2	63.7	62.7	62.2	61.7	60.7	59.7

June 22^d—23^d, 1842. The clock in the Magnetic Observatory was not going well during this term, owing to the lever of the 30^s bell affecting the motion of the pendulum. The following were the errors during the term: 22^d 9^h, error 0^s; 23^d 0^h 30^m, error —4^s, clock put fast 2^s; 23^d 2^h, error —5^s, clock put fast 2^s, and 30^s bell stopped. The error of +2^s continued throughout the rest of the term.

Göttingen Mean Time of Declination Observation.													JUNE 22, 23.												
Min.	18 ^h .			22 ^h .			2 ^h .			6 ^h .															
	DECLINATION.	BIFILAR Corrected.	BALANCE Corrected.	DECLINATION.	BIFILAR Corrected.	BALANCE Corrected.	DECLINATION.	BIFILAR Corrected.	BALANCE Corrected.	DECLINATION.	BIFILAR Corrected.	BALANCE Corrected.													
	Sec. Div.	Mic. Div.		Sec. Div.	Mic. Div.		Sec. Div.	Mic. Div.		Sec. Div.	Mic. Div.														
0	130-20	518-2	763-0	129-52	518-7	809-0	133-02	548-5	796-2	129-43	553-3	809-1													
6	132-91	521-3	767-7	130-12	516-7	806-5	132-80	545-9	796-8	128-78	550-6	811-0													
12	131-27	525-9	763-5	127-45	525-3	802-0	132-73	542-6	798-9	128-47	552-4	812-6													
18	131-15	521-6	757-0	128-20	522-6	802-7	131-62	538-1	799-6	128-75	551-4	813-1													
24	132-80	516-9	754-9	127-10	525-5	799-7	131-72	542-0	800-2	128-68	553-4	812-3													
30	131-82	521-0	749-5	128-63	521-4	798-5	131-78	540-9	801-8	128-97	560-5	809-8													
36	131-29	520-6	756-3	128-10	521-7	797-6	132-17	541-4	804-0	128-83	563-6	807-7													
42	129-78	522-9	768-9	127-12	523-3	795-4	131-83	540-7	806-2	128-78	562-9	812-2													
48	130-89	521-2	775-6	127-01	526-6	795-6	131-50	545-0	804-7	128-30	563-5	814-0													
54	131-07	522-3	127-17	527-5	792-3	131-00	542-4	809-3	128-55	565-9	814-4													
19 ^h .													23 ^h .			3 ^h .			7 ^h .						
0	130-83	522-2	773-2	127-81	528-4	791-4	131-23	544-1	810-6	128-74	567-6	821-4													
6	129-82	522-3	774-9	127-98	528-6	791-9	130-63	545-6	808-0	128-21	559-7	826-8													
12	128-97	518-9	776-3	128-63	527-9	790-2	130-58	546-0	810-5	128-17	559-1	830-0													
18	130-07	523-8	775-3	128-21	528-1	786-5	130-95	554-5	809-4	127-95	560-4	833-2													
24	129-96	526-2	770-9	128-38	528-2	784-9	131-15	552-3	812-9	127-52	563-4	838-5													
30	128-92	525-6	769-5	128-57	529-2	783-9	130-72	547-0	815-7	127-28	562-6	842-3													
36	124-24	522-6	767-8	129-00	532-2	782-8	130-73	545-0	816-1	126-15	566-4	845-3													
42	126-39	529-5	773-4	129-93	527-9	783-6	130-50	546-1	815-5	125-00	561-4	857-0													
48	130-73	521-3	773-1	526-5	792-2	131-09	548-3	813-5	125-80	555-8	861-2													
54	125-30	515-2	781-7	132-22	525-4	791-6	130-92	547-8	810-9	121-27	563-7	856-3													
20 ^h .													0 ^h .			4 ^h .			8 ^h .						
0	123-02	517-2	781-4	131-52	541-1	789-1	131-03	546-1	810-6	122-85	548-0	849-6													
6	129-05	516-9	787-5	131-27	535-5	789-8	131-10	546-4	809-3	116-95	571-2	843-3													
12	124-35	518-2	788-5	131-76	532-6	789-9	130-95	545-9	809-1	120-60	570-9	844-0													
18	126-37	519-7	788-6	135-26	523-3	795-8	130-70	544-5	807-7	121-20	565-6	842-4													
24	126-63	518-0	790-2	132-38	523-8	799-3	130-60	544-7	808-5	121-25	565-2	840-8													
30	126-66	519-1	787-9	135-20	522-5	800-9	130-53	545-8	805-8	122-27	563-7	839-6													
36	127-72	514-7	794-6	135-55	526-5	799-6	130-18	548-3	801-8	122-24	561-8	838-7													
42	127-77	515-1	793-9	135-72	521-6	798-5	130-18	550-6	804-4	122-97	559-8	839-7													
48	129-52	518-1	797-0	135-72	528-2	799-8	130-00	549-3	802-8	124-45	554-9	840-9													
54	127-97	522-0	791-8	135-35	529-3	802-5	130-00	547-5	803-3	124-88	548-2	839-2													
21 ^h .													1 ^h .			5 ^h .			9 ^h .						
0	129-35	521-3	793-6	137-23	532-7	803-5	129-73	549-2	804-6	123-71	549-0	837-9													
6	129-72	516-4	798-2	136-45	525-2	804-7	129-95	555-0	804-3	124-52	547-4	839-3													
12	129-00	516-3	800-2	136-45	536-0	802-2	129-55	554-4	802-7	125-25	550-8	836-4													
18	126-53	512-9	798-4	135-46	534-6	803-6	129-62	556-5	803-8	126-25	550-2	834-8													
24	124-17	513-7	797-2	135-59	533-8	803-0	129-17	551-8	807-4	126-77	549-8	832-1													
30	124-22	514-2	800-3	134-17	537-0	801-1	129-05	550-2	808-0	127-20	549-4	831-2													
36	122-22	518-2	801-2	134-07	537-0	800-5	129-00	554-4	808-1	127-14	551-5	827-6													
42	124-83	516-3	803-3	133-31	538-6	798-8	129-28	555-8	808-1	127-63	551-7	827-2													
48	126-26	520-1	801-5	132-87	542-5	796-8	129-65	560-6	804-6	126-35	551-7	823-4													
54	127-85	520-2	800-3	132-93	545-4	796-1	129-98	560-3	808-3	125-99	554-6	821-6													
Hour,	18	19	20	21	22	23	0	1	2	3	4	5	6	7	8	9	10								
BIFILAR THERMOMETER,	59-0	58-9	58-6	58-7	59-7	60-9	62-1	63-2	64-7	66-0	66-9	67-5	67-3	66-7	65-5	64-9	65-2								
BALANCE THERMOMETER,	59.5	59-2	59-2	59-2	60-0	60-7	61-7	62-7	65-0	66-3	66-3	66-4	66-3	66-2	66-3	64-8	64-2								

June 22^d—23^d. See note on page 38.

Göttingen Mean Time of Declination Observation.		JULY 20, 21.															
		DECLINA- TION.			DECLINA- TION.			DECLINA- TION.			DECLINA- TION.						
		BIFILAR Corrected.	BALANCE Corrected.		BIFILAR Corrected.	BALANCE Corrected.		BIFILAR Corrected.	BALANCE Corrected.		BIFILAR Corrected.	BALANCE Corrected.					
Min.	Sc. Div.	Mic. Div.	Sc. Div.	Mic. Div.		Sc. Div.	Mic. Div.		Sc. Div.	Mic. Div.		Sc. Div.	Mic. Div.				
	10 ^h .			14 ^h .			18 ^h .			22 ^h .							
0	116.77	536.7	814.4	125.35	540.0	751.2	123.07	531.3	800.6	123.22	527.4	796.4					
6	117.57	536.4	813.0	124.99	541.4	752.3	122.55	530.0	799.8	123.97	528.1	796.7					
12	118.52	538.3	813.9	125.62	540.8	753.4	122.04	530.1	798.5	123.87	526.7	795.0					
18	120.20	538.3	809.7	125.63	539.8	753.9	122.04	530.8	798.7	123.77	526.2	793.3					
24	120.25	538.8	805.7	125.65	539.5	754.2	122.90	529.7	799.7	124.07	526.3	792.9					
30	120.35	540.7	801.4	125.52	538.5	752.6	122.51	530.1	801.1	124.20	526.4	792.5					
36	121.02	543.0	798.5	124.27	538.8	753.9	122.30	529.3	802.5	124.24	525.2	790.4					
42	122.60	539.9	799.1	123.97	539.6	754.6	122.07	530.2	804.7	124.30	525.1	790.4					
48	123.70	539.8	797.7	123.60	539.6	754.6	121.93	531.5	802.7	124.62	526.3	787.6					
54	123.68	538.3	797.1	123.60	538.5	755.8	122.04	532.6	802.6	124.77	526.6	786.5					
	11 ^h .			15 ^h .			19 ^h .			23 ^h .							
0	124.50	536.7	795.4	122.93	537.1	757.7	121.70	532.7	804.0	125.22	526.9	785.2					
6	123.58	535.1	792.9	122.27	537.6	758.2	121.98	532.4	802.8	125.00	523.9	782.7					
12	122.28	535.9	791.1	121.77	537.7	761.5	121.70	532.9	803.9	124.35	527.8	781.1					
18	121.65	534.4	792.0	121.58	538.0	762.5	121.52	532.8	801.9	125.43	528.7	781.4					
24	121.10	535.2	790.4	121.35	536.2	764.4	121.10	533.7	804.1	125.68	529.4	781.6					
30	120.78	535.9	790.4	121.25	534.6	766.8	121.40	534.2	804.7	126.02	529.3	780.8					
36	120.78	535.5	790.7	121.58	534.9	768.6	121.58	532.2	803.5	126.45	529.8	781.1					
42	121.18	534.3	791.6	122.35	534.1	771.1	121.75	532.3	802.8	126.72	529.7	781.3					
48	121.77	535.1	791.7	122.78	534.0	771.1	121.70	532.1	802.1	126.85	531.5	780.6					
54	122.10	535.8	790.1	123.08	534.7	773.7	121.12	532.6	803.6	127.28	534.7	780.2					
	12 ^h .			16 ^h .			20 ^h .			0 ^h .							
0	122.60	534.8	792.9	123.60	535.5	774.9	120.93	530.8	802.9	127.92	534.6	782.3					
6	122.38	535.1	790.8	123.84	535.5	774.6	120.80	530.0	804.7	128.74	532.8	784.4					
12	122.87	534.4	791.6	123.98	535.1	775.4	120.98	529.8	804.8	129.14	534.5	783.1					
18	122.80	534.1	791.1	123.73	536.2	776.3	121.47	530.1	805.7	129.65	534.1	783.6					
24	123.47	534.4	790.0	123.68	537.0	778.8	121.02	530.6	804.0	130.10	532.9	784.5					
30	124.48	538.6	787.7	124.53	533.7	779.4	121.71	526.9	804.7	130.33	533.2	784.5					
36	127.74	543.7	781.3	124.37	538.5	784.1	119.78	530.8	803.3	130.75	533.6	785.0					
42	129.69	545.3	772.9	124.77	535.5	784.5	120.35	531.4	803.6	131.45	533.9	786.8					
48	129.07	545.0	765.6	124.27	535.5	787.0	121.05	530.3	803.7	131.63	534.0	786.8					
54	128.07	544.7	760.0	124.18	536.0	789.6	121.30	529.0	804.4	132.11	532.9	787.5					
	13 ^h .			17 ^h .			21 ^h .			1 ^h .							
0	127.94	543.2	755.4	124.00	532.8	791.7	121.12	528.5	802.6	132.18	531.9	788.2					
6	127.85	541.7	752.0	123.51	534.4	792.1	121.00	528.5	801.5	131.92	533.8	787.7					
12	127.48	539.7	750.2	123.42	534.2	792.3	121.43	528.0	801.0	131.96	535.4	788.3					
18	127.23	538.3	750.3	123.22	533.8	795.9	121.49	528.6	800.4	132.28	533.4	790.3					
24	126.22	538.9	748.3	123.40	532.4	797.9	121.84	528.7	799.5	132.11	532.6	790.8					
30	125.62	539.3	747.1	123.73	532.1	802.0	122.25	528.7	799.0	132.42	534.8	790.7					
36	125.12	540.8	746.4	124.40	531.3	800.3	122.84	528.4	799.0	132.65	538.2	790.6					
42	124.88	541.1	748.7	123.80	532.7	800.6	122.91	527.6	797.4	132.87	538.9	792.4					
48	124.95	540.3	751.0	123.42	531.4	799.9	122.98	528.0	796.7	132.65	539.0	793.8					
54	125.23	540.5	751.2	123.42	530.9	799.3	123.38	526.8	795.8	132.35	540.5	794.1					
Hour,		10	11	12	13	14	15	16	17	18	19	20	21	22	23	0	1
BIFILAR THERMOMETER, .		58.2	58.4	58.1	58.6	58.9	59.1	59.0	59.0	58.9	59.5	59.1	59.4	59.8	60.6	61.6	62.4
BALANCE THERMOMETER, .		58.2	58.3	58.7	58.7	58.7	58.7	58.7	58.7	58.7	59.0	59.2	59.3	59.4	60.1	60.8	61.7

Göttingen Mean Time of Declination Observation.	JULY 20, 21.						AUGUST 26, 27.										
	DECLINA- TION.	BIFILAR Corrected.	BALANCE Corrected.	DECLINA- TION.	BIFILAR Corrected.	BALANCE Corrected.	DECLINA- TION.	BIFILAR Corrected.	BALANCE Corrected.	DECLINA- TION.	BIFILAR Corrected.	BALANCE Corrected.					
	Min.	Sc. Div.	Mic. Div.	'	Sc. Div.	Mic. Div.	'	Sc. Div.	Mic. Div.	'	Sc. Div.	Mic. Div.					
	2 ^h .			6 ^h .			10 ^h .			14 ^h .							
0	132-38	538-9	797-0	128-48	546-0	791-7	123-11	551-8	774-3	120-32	544-7	685-0					
6	132-60	539-2	795-4	128-41	546-0	791-8	123-53	548-5	772-5	120-35	541-6	688-8					
12	132-30	533-8	798-0	128-30	546-1	791-1	123-85	551-1	766-3	120-72	536-7	693-6					
18	132-70	533-4	798-1	127-94	546-1	793-3	125-46	553-3	754-7	120-32	533-6	700-9					
24	132-88	533-0	796-6	127-54	547-6	797-7	124-82	546-4	752-7	120-83	532-9	703-3					
30	132-80	532-7	793-8	127-15	546-6	801-5	123-60	543-5	752-1	121-49	531-2	706-1					
36	132-97	535-6	790-7	127-08	547-2	801-8	122-93	544-7	745-7	122-42	529-6	712-7					
42	132-90	536-4	790-6	127-12	547-5	801-1	123-10	544-7	746-5	124-57	528-7	711-8					
48	132-73	535-7	790-2	127-40	548-0	800-8	123-10	541-3	746-4	125-88	528-3	708-9					
54	132-53	535-4	789-4	126-97	548-4	801-3	122-30	540-5	748-8	125-63	531-5	709-0					
	3 ^h .			7 ^h .			11 ^h .			15 ^h .							
0	132-17	536-6	788-8	126-57	548-1	802-3	122-30	542-8	750-8	126-98	538-1	708-1					
6	131-47	534-8	788-9	126-32	548-2	803-5	122-57	543-9	747-5	127-41	538-8	706-3					
12	131-16	537-6	789-4	126-08	547-1	805-2	122-17	545-4	747-4	127-00	539-1	709-8					
18	130-35	540-3	788-3	126-12	546-7	806-4	123-87	549-4	742-2	128-12	537-8	709-7					
24	129-65	541-0	788-7	125-82	547-0	807-8	125-79	551-6	740-3	128-15	536-6	709-9					
30	129-50	544-5	788-9	125-55	548-0	808-7	129-21	552-2	731-1	127-27	536-1	709-0					
36	130-38	550-8	789-4	125-59	547-0	809-4	132-51	548-6	721-8	125-97	536-8	709-4					
42	129-83	546-0	792-6	125-70	547-7	810-3	133-13	544-2	709-4	125-00	538-4	710-9					
48	129-65	543-8	795-4	125-80	547-7	811-0	131-07	541-7	700-8	124-59	539-0	715-6					
54	129-82	543-0	798-6	125-99	548-5	809-6	128-37	543-1	695-2	123-55	539-2	718-2					
	4 ^h .			8 ^h .			12 ^h .			16 ^h .							
0	129-78	542-5	799-9	126-33	548-4	808-1	125-79	546-8	691-2	122-75	540-0	719-1					
6	129-85	541-2	799-8	126-08	545-9	805-9	123-02	548-7	688-6	122-87	539-9	723-3					
12	130-02	540-6	801-7	125-25	546-0	805-2	122-70	549-4	685-3	122-97	539-6	723-9					
18	130-29	542-5	800-8	124-46	547-8	806-9	120-92	545-1	688-3	122-10	541-0	727-7					
24	130-32	544-7	799-8	124-25	548-7	807-0	119-62	543-0	689-7	122-40	540-3	730-3					
30	130-55	546-4	799-3	124-73	547-8	810-8	118-90	543-0	692-3	122-17	539-3	733-4					
36	130-32	545-2	800-1	125-23	546-5	811-4	118-10	543-2	697-6	121-88	539-4	735-1					
42	130-47	542-8	800-5	125-62	544-9	809-9	117-47	541-3	701-7	121-65	540-3	737-2					
48	130-53	540-4	799-2	125-68	544-4	808-1	118-21	538-5	702-2	121-77	540-1	738-7					
54	130-33	543-7	798-5	125-65	544-7	808-5	119-60	536-3	705-2	121-58	540-2	739-0					
	5 ^h .			9 ^h .			13 ^h .			17 ^h .							
0	130-52	546-2	799-3	125-62	542-7	807-9	120-27	532-2	710-3	122-20	540-2	740-0					
6	130-47	545-7	798-2	125-62	542-7	809-7	122-80	532-1	712-2	122-30	540-7	744-5					
12	129-96	544-0	797-1	125-97	541-1	808-7	124-77	536-7	708-4	121-77	541-3	744-4					
18	129-69	544-5	797-3	126-10	543-3	808-5	125-70	540-1	705-9	122-20	539-7	745-5					
24	129-27	547-1	794-8	126-28	542-2	808-1	128-00	542-5	701-8	121-87	539-4	747-5					
30	129-32	547-3	796-4	126-23	541-9	807-5	128-77	545-0	698-5	121-65	540-0	747-5					
36	129-10	547-8	793-8	126-15	541-1	807-5	127-92	548-9	691-3	121-58	539-0	749-0					
42	129-34	547-3	792-9	126-22	540-9	808-0	126-28	549-4	685-9	121-50	537-8	749-4					
48	129-30	547-1	793-9	126-33	543-7	803-8	124-27	548-0	682-8	121-29	537-7	750-8					
54	128-77	546-1	792-3	126-17	542-7	803-0	122-02	546-5	683-6	121-25	537-5	752-5					
Hour,	2	3	4	5	6	7	8	9	10	10	11	12	13	14	15	16	17
BIFILAR THERMOMETER,	63-2	63-5	63-6	63-7	63-7	63-7	63-7	61-8	60-6	60-8	61-1	61-6	61-7	61-5	61-5	61-4	61-4
BALANCE THERMOMETER,	62-3	62-7	62-9	63-1	62-9	63-2	63-2	61-9	60-9	61-0	61-2	61-7	61-7	61-7	61-8	61-7	61-7

TERM-DAY OBSERVATIONS OF MAGNETOMETERS, 1842.

Göttingen Mean Time of Declination Observation.	AUGUST 26, 27.																
	DECLINA- TION.	BIFILAR Corrected.	BALANCE Corrected.	DECLINA- TION.	BIFILAR Corrected.	BALANCE Corrected.	DECLINA- TION.	BIFILAR Corrected.	BALANCE Corrected.	DECLINA- TION.	BIFILAR Corrected.	BALANCE Corrected.					
	Min.	Sec. Div.	Mic. Div.	'	Sec. Div.	Mic. Div.	'	Sec. Div.	Mic. Div.	'	Sec. Div.	Mic. Div.					
	18h.			22h.			2h.			6h.							
0	121-20	537-1	756-2	122-22	531-2	765-3	131-45	542-7	754-1	126-08	554-4	759-5					
6	120-92	536-5	756-4	123-53	529-0	764-5	131-07	544-2	755-0	125-93	554-4	760-6					
12	120-72	535-6	758-5	123-42	528-5	765-8	131-03	544-7	755-4	125-55	549-2	762-2					
18	120-93	534-4	758-6	122-95	528-7	760-7	130-73	543-0	756-4	125-45	552-8	759-9					
24	120-73	534-7	762-8	123-48	529-0	760-7	130-05	542-3	756-2	125-28	553-8	760-3					
30	120-85	535-0	764-8	123-40	528-4	759-7	129-80	543-7	756-0	125-42	555-8	760-0					
36	120-83	534-1	767-7	123-91	527-6	760-3	129-78	544-2	756-5	125-15	554-1	763-2					
42	120-36	534-0	767-4	124-15	527-4	760-4	129-78	549-6	757-6	125-10	552-0	761-8					
48	120-85	532-2	769-4	124-57	525-6	760-4	130-09	554-7	757-8	125-25	555-5	760-7					
54	121-49	530-9	769-3	124-62	523-0	759-7	130-38	554-4	759-1	125-46	554-7	761-7					
	19h.			23h.			3h.			7h.							
0	121-80	528-5	770-7	124-85	525-8	761-9	129-18	550-5	760-5	125-45	553-2	762-2					
6	122-67	526-2	771-8	124-79	525-2	761-3	129-35	549-2	760-6	125-50	554-0	762-2					
12	123-70	526-3	771-1	125-37	524-7	760-6	129-76	548-8	762-3	125-59	554-7	762-1					
18	124-52	525-5	768-2	125-63	523-5	761-6	129-52	549-5	762-9	125-48	552-3	764-8					
24	125-35	526-4	767-2	126-39	523-0	760-5	129-87	551-7	762-1	125-42	554-0	764-7					
30	124-79	529-7	763-0	126-63	523-0	760-4	129-95	551-1	763-6	125-55	554-7	764-3					
36	124-39	531-0	761-4	126-85	524-6	759-6	129-76	547-9	763-7	125-63	554-7	764-6					
42	124-10	532-2	760-9	127-28	526-5	759-4	129-21	546-1	763-6	125-52	554-8	763-8					
48	123-82	532-1	760-4	127-70	526-7	758-5	129-21	547-9	763-7	125-22	553-3	764-6					
54	123-53	532-6	759-2	128-23	522-7	758-4	129-18	546-6	760-0	125-02	552-5	765-6					
	20h.			0h.			4h.			8h.							
0	123-00	533-8	758-1	127-70	522-6	756-7	129-58	554-5	759-2	125-30	550-7	767-0					
6	122-93	535-2	756-9	128-08	525-8	755-9	128-95	551-9	751-9	125-50	550-3	767-2					
12	123-15	537-1	756-2	128-80	527-6	753-3	128-54	553-9	749-6	125-60	548-6	767-6					
18	123-40	535-7	755-5	129-07	528-6	750-6	128-77	555-3	751-0	125-55	548-6	768-2					
24	122-95	536-1	754-4	129-25	527-9	748-7	128-68	556-3	752-5	125-62	550-4	768-8					
30	123-11	536-0	752-3	129-52	528-7	747-8	128-34	555-7	752-7	125-32	550-1	767-1					
36	122-65	535-1	754-1	129-35	528-4	744-1	128-17	557-9	754-5	125-15	549-5	766-6					
42	122-62	535-1	754-2	129-47	529-3	741-7	127-85	556-5	755-7	125-62	549-8	764-1					
48	122-28	535-8	754-5	129-38	532-9	739-8	127-63	557-1	755-7	125-62	551-0	759-7					
54	121-80	535-4	754-9	130-27	536-4	738-7	127-60	557-4	753-8	125-62	550-0	759-5					
	21h.			1h.			5h.			9h.							
0	122-07	533-1	751-9	131-18	537-6	740-3	127-43	556-9	755-3	125-92	548-1	759-9					
6	121-73	531-1	759-4	131-33	536-7	738-5	127-08	553-5	756-7	125-93	547-7	756-2					
12	121-90	532-8	760-5	131-65	535-0	741-7	126-80	554-8	756-3	125-83	549-9	753-2					
18	121-80	532-3	763-9	131-09	535-0	741-8	126-32	552-2	757-1	125-77	548-7	752-7					
24	121-98	532-2	765-5	131-30	536-4	742-7	126-28	552-6	757-7	125-53	546-3	751-7					
30	122-24	532-5	766-6	131-47	537-6	743-7	126-28	554-2	762-1	125-46	553-3	747-9					
36	122-82	531-0	768-1	131-47	540-0	745-5	126-32	554-6	761-9	125-65	553-4	745-2					
42	123-20	532-1	768-7	131-35	539-0	747-0	126-35	554-7	761-2	125-73	554-2	742-5					
48	123-20	531-1	768-1	131-40	540-5	749-7	126-40	554-1	760-2	125-62	552-6	743-7					
54	123-17	530-0	767-6	131-33	541-8	751-8	126-28	553-7	759-8	125-26	550-7	743-8					
HOUR,	18	19	20	21	22	23	0	1	2	3	4	5	6	7	8	9	10
BIFILAR THERMOMETER,	61-1	60-7	60-5	60-4	60-7	60-8	62-7	63-3	64-4	65-2	66-0	66-7	67-4	64-9	64-0	64-2	64-3
BALANCE THERMOMETER,	61-7	61-1	60-7	60-5	60-8	60-9	62-5	63-2	63-9	64-5	65-3	65-8	66-3	64-5	63-7	64-1	64-2

Göttingen Mean Time of Declination Observation.	SEPTEMBER 21, 22.															
	DECLINA- TION.	BIFILAR Corrected.	BALANCE Corrected.	DECLINA- TION.	BIFILAR Corrected.	BALANCE Corrected.	DECLINA- TION.	BIFILAR Corrected.	BALANCE Corrected.	DECLINA- TION.	BIFILAR Corrected.	BALANCE Corrected.				
	Min.	Sec. Div.	Mic. Div.	'	Sec. Div.	Mic. Div.	'	Sec. Div.	Mic. Div.	'	Sec. Div.	Mic. Div.				
	10 ^h .			14 ^h .			18 ^h .			22 ^h .						
0	122.60	546.2	746.1	128.78	530.6	660.8	129.92	537.6	755.3	135.59	521.7	761.6				
6	122.75	539.5	747.0	126.39	534.3	669.1	129.95	538.2	756.9	135.68	519.9	766.2				
12	122.93	533.4	748.8	124.53	537.6	676.1	130.42	540.0	756.7	133.45	522.6	767.7				
18	121.42	542.7	748.3	125.85	536.6	686.9	131.05	540.1	758.6	135.57	520.9	770.3				
24	121.16	544.2	745.8	126.22	534.9	693.1	131.12	539.5	757.1	134.95	519.2	771.5				
30	120.02	550.3	741.4	125.28	537.0	697.2	131.35	540.1	754.8	134.82	519.3	770.3				
36	121.10	552.3	739.8	125.63	538.5	702.5	131.05	540.9	754.8	135.62	520.4	770.3				
42	122.88	547.6	738.5	125.83	536.8	708.8	130.85	540.0	755.4	136.50	522.7	770.7				
48	122.51	544.6	736.0	126.19	535.5	715.7	130.69	539.9	757.9	137.35	523.4	772.7				
54	123.60	539.4	740.4	126.59	534.5	722.0	130.52	539.4	760.2	137.48	522.2	769.3				
	11 ^h .			15 ^h .			19 ^h .			23 ^h .						
0	122.97	538.2	740.2	126.52	535.6	726.4	130.15	538.6	762.6	136.30	528.2	768.1				
6	122.85	537.0	743.3	126.28	537.0	732.5	130.42	539.7	764.4	137.83	528.4	767.6				
12	123.28	536.8	745.1	126.62	537.8	737.0	130.70	538.9	767.3	137.88	532.8	768.7				
18	124.40	536.4	743.2	126.94	537.7	743.9	130.83	537.8	768.6	137.32	530.9	763.4				
24	124.88	529.8	746.0	127.41	537.5	748.2	130.78	536.6	769.7	137.95	530.5	764.0				
30	123.88	519.3	748.6	128.57	537.0	753.0	131.05	537.4	769.9	138.34	530.5	764.6				
36	125.52	524.2	749.8	128.57	537.7	758.1	130.45	536.7	771.2	138.37	531.9	762.9				
42	127.38	525.8	750.5	128.85	538.8	760.9	130.78	536.8	772.4	138.47	532.7	760.8				
48	128.30	527.2	751.5	128.35	540.4	761.9	130.52	535.4	772.9	139.40	529.8	760.2				
54	128.03	528.7	756.2	128.50	540.9	761.8	130.98	535.1	773.1	139.76	529.0	758.6				
	12 ^h .			16 ^h .			20 ^h .			0 ^h .						
0	128.97	530.2	762.0	128.07	542.5	762.6	130.15	534.3	773.7	139.55	531.9	755.8				
6	128.97	533.0	759.2	127.67	542.7	763.1	131.02	534.9	772.2	140.13	536.2	755.7				
12	127.95	538.7	760.8	127.55	541.6	765.1	131.78	535.3	771.6	140.43	530.1	754.2				
18	126.97	441.7	759.4	127.28	543.6	765.6	132.17	535.3	770.3	139.43	533.8	752.4				
24	127.30	542.6	753.0	128.88	541.9	765.7	132.84	333.8	770.5	139.87	535.1	751.1				
30	126.72	541.5	751.0	129.43	541.5	764.8	133.50	530.6	770.3	140.36	535.0	750.2				
36	126.59	538.0	747.3	127.97	542.5	764.0	134.33	528.4	770.1	140.02	536.5	750.0				
42	126.62	541.9	740.4	128.88	544.2	764.8	134.40	528.1	767.5	140.53	538.4	747.3				
48	130.38	548.7	729.1	129.12	542.8	763.7	134.58	528.0	763.8	140.53	538.8	746.9				
54	129.52	546.6	724.1	128.57	544.7	764.4	134.25	527.5	765.5	140.69	540.2	748.1				
	13 ^h .			17 ^h .			21 ^h .			1 ^h .						
0	127.17	554.4	726.5	128.80	545.6	758.7	133.70	527.0	764.3	141.18	539.7	749.0				
6	131.18	560.7	725.5	129.15	545.5	757.2	133.50	525.0	762.1	140.42	539.7	748.5				
12	136.40	555.6	713.7	128.38	546.8	756.0	132.97	526.9	761.1	141.73	543.5	746.7				
18	138.27	543.1	693.6	128.72	547.3	754.7	132.88	526.1	761.9	141.02	541.1	746.8				
24	137.70	537.0	674.6	128.87	542.5	753.8	132.60	523.3	760.5	141.05	542.4	748.1				
30	136.40	531.0	660.8	129.49	541.8	752.4	132.28	525.5	760.7	141.02	543.4	746.1				
36	134.68	526.6	650.3	129.87	541.7	751.3	133.37	523.3	760.7	141.65	541.5	748.4				
42	132.25	525.3	641.5	129.92	538.2	752.1	134.60	520.7	761.8	140.40	544.5	749.3				
48	130.47	528.2	644.0	130.90	538.9	751.4	134.37	520.3	761.7	140.18	542.7	750.9				
54	129.65	530.9	650.3	129.55	537.1	752.3	134.73	520.3	761.7	140.38	545.9	750.8				
Hour,	10	11	12	13	14	15	16	17	18	19	20	21	22	23	0	1
BIFILAR THERMOMETER, .	57.8	57.6	57.1	56.8	58.1	58.1	58.7	60.6	61.0	60.5	59.9	59.7	59.6	60.6	61.5	61.8
BALANCE THERMOMETER, .	57.9	58.2	57.9	57.9	59.2	59.2	60.2	61.9	61.9	61.4	61.1	60.7	60.5	61.7	62.7	62.9

TERM-DAY OBSERVATIONS OF MAGNETOMETERS, 1842.

Göttingen Mean Time of Declination Observation.	SEPTEMBER 21, 22.						OCTOBER 19, 20.										
	DECLINATION.	BIFILAR Corrected.	BALANCE Corrected.	DECLINATION.	BIFILAR Corrected.	BALANCE Corrected.	DECLINATION.	BIFILAR Corrected.	BALANCE Corrected.	DECLINATION.	BIFILAR Corrected.	BALANCE Corrected.					
	Min.	Sec. Div.	Mic. Div.	Min.	Sec. Div.	Mic. Div.	Min.	Sec. Div.	Mic. Div.	Min.	Sec. Div.	Mic. Div.					
	2h.			6h.			10h.			14h.							
0	140-23	548-2	754-4	133-07	546-8	780-4	122-90	573-1	771-7	130-42	540-1	712-3					
6	140-65	544-0	758-2	133-64	553-1	777-9	129-40	572-4	748-8	129-82	542-3	715-1					
12	139-47	542-4	761-7	132-71	551-5	779-9	131-38	554-7	738-5	129-34	542-7	717-5					
18	139-42	540-4	762-3	132-05	545-0	781-3	130-32	539-0	738-3	128-90	543-6	719-4					
24	138-12	540-1	768-2	132-50	547-6	779-3	125-90	534-9	740-8	128-28	544-0	719-8					
30	137-37	540-6	766-5	133-50	551-0	778-2	122-47	536-9	741-2	127-90	542-6	721-8					
36	135-99	543-9	766-8	134-33	547-7	778-2	119-38	544-2	743-8	128-63	541-1	723-2					
42	136-13	545-4	768-1	134-47	549-9	777-0	118-03	547-5	744-7	128-88	541-8	724-2					
48	135-82	547-2	767-9	134-57	547-9	778-5	116-26	554-0	743-8	129-12	541-0	725-4					
54	136-30	552-8	768-6	134-95	539-1	783-9	117-54	554-7	745-8	129-34	540-8	725-9					
	3h.			7h.			11h.			15h.							
0	137-02	552-3	769-5	133-50	536-2	791-2	119-00	549-2	751-4	129-35	540-8	726-6					
6	137-72	554-4	771-0	132-50	539-5	796-7	120-38	543-1	754-9	128-54	542-8	725-5					
12	137-70	556-6	774-0	132-90	536-1	802-6	120-82	542-8	755-2	128-85	541-2	726-5					
18	136-93	546-8	776-1	131-78	534-7	800-1	121-16	543-1	756-6	128-45	540-3	728-0					
24	136-79	547-4	775-2	124-55	553-9	791-0	123-28	541-4	756-1	128-61	541-7	729-7					
30	136-52	546-8	775-3	111-10	579-8	776-8	124-75	539-0	756-4	128-94	540-3	730-7					
36	136-59	550-9	773-4	115-68	573-5	765-8	124-82	539-2	756-3	128-47	541-2	731-6					
42	137-34	553-6	775-3	123-27	563-9	757-9	124-72	540-7	754-4	128-60	541-3	731-9					
48	136-83	550-2	777-4	132-70	539-3	759-4	124-97	541-4	753-0	128-45	541-6	732-7					
54	136-77	553-9	778-7	134-65	524-2	761-4	124-72	541-8	752-2	128-14	541-3	733-6					
	4h.			8h.			12h.			16h.							
0	136-95	549-4	780-4	131-33	520-5	756-1	123-75	542-1	750-5	127-57	541-2	734-9					
6	136-46	547-5	782-0	127-58	532-7	755-5	123-65	541-2	750-5	126-90	540-5	736-3					
12	136-42	552-4	782-0	128-38	530-5	757-0	123-35	540-5	746-5	126-66	539-7	738-2					
18	136-15	549-0	782-6	126-35	533-0	757-9	122-75	538-9	748-3	126-48	538-9	739-9					
24	135-68	546-4	783-0	127-77	536-0	761-4	123-13	538-1	747-1	126-06	538-3	742-2					
30	135-53	544-7	780-5	129-56	535-0	764-0	123-95	537-5	747-7	126-06	537-7	746-0					
36	135-62	551-1	779-7	129-69	532-8	766-8	124-24	538-0	747-1	126-59	538-9	748-7					
42	135-48	552-6	784-8	128-75	533-6	767-8	127-03	542-2	746-5	127-63	539-6	749-3					
48	134-60	545-8	782-8	128-65	535-4	769-0	130-67	543-2	743-0	127-54	539-1	750-0					
54	134-58	544-6	786-6	129-08	536-4	769-9	131-95	543-1	736-5	127-60	538-5	749-4					
	5h.			9h.			13h.			17h.							
0	134-42	544-5	786-0	129-63	537-0	770-3	131-50	543-4	733-0	126-97	537-7	750-1					
6	134-72	544-8	783-2	129-41	539-6	769-6	132-13	545-0	730-2	126-98	537-9	750-9					
12	134-13	545-6	782-8	129-50	538-3	768-2	136-55	550-4	721-1	127-60	539-1	749-4					
18	133-31	546-2	777-7	129-40	537-9	768-6	138-23	548-8	714-2	127-63	539-3	749-3					
24	133-93	546-6	777-6	128-94	539-5	769-7	137-60	546-3	705-3	127-68	539-1	748-3					
30	133-80	544-4	775-4	129-08	536-7	770-5	136-15	545-5	698-9	127-68	539-3	749-6					
36	133-18	545-3	776-6	129-27	538-3	770-4	134-00	543-4	695-7	127-80	539-6	750-7					
42	133-35	546-9	772-7	538-9	768-5	132-70	540-9	695-5	127-65	539-6	750-4					
48	133-37	546-0	776-0	129-07	545-7	760-1	131-43	540-5	697-5	128-14	540-3	752-5					
54	133-55	547-1	778-0	128-00	547-8	753-5	130-75	540-1	706-7	128-00	538-6	752-4					
Hour,	2	3	4	5	6	7	8	9	10	10	11	12	13	14	15	16	17
BIFILAR THERMOMETER,	62-5	62-5	61-9	61-4	60-6	59-3	59-0	58-6	58-3	46-6	48-5	50-6	51-9	52-3	51-8	50-6	49-8
BALANCE THERMOMETER,	62-5	63-2	62-9	62-7	61-7	60-4	60-4	59-9	59-3	49-1	49-9	52-0	53-4	53-8	53-3	52-2	51-8

Göttingen Mean Time of Declination Observation.													OCTOBER 19, 20.												
Min.	DECLINATION.	BIFILAR Corrected.	BALANCE Corrected.	DECLINATION.	BIFILAR Corrected.	BALANCE Corrected.	DECLINATION.	BIFILAR Corrected.	BALANCE Corrected.	DECLINATION.	BIFILAR Corrected.	BALANCE Corrected.	DECLINATION.	BIFILAR Corrected.	BALANCE Corrected.										
		Sc. Div.	Mic. Div.		Sc. Div.	Mic. Div.		Sc. Div.	Mic. Div.		Sc. Div.	Mic. Div.		Sc. Div.	Mic. Div.										
	18h.			22h.			2h.			6h.															
0	127-95	538-4	750-0	126-43	533-8	770-9	135-86	545-7	760-2	129-60	545-7	765-6													
6	126-60	541-4	753-5	127-32	532-9	770-4	136-28	544-1	763-9	129-69	544-0	763-2													
12	127-63	538-7	753-3	127-08	534-7	767-6	137-41	546-1	763-5	129-41	547-5	760-3													
18	128-03	537-8	760-2	128-47	535-3	763-8	137-37	544-9	763-0	130-07	549-4	763-5													
24	128-14	536-8	759-9	129-87	532-3	763-7	136-62	544-6	760-5	130-09	549-0	765-3													
30	127-18	539-6	761-0	128-88	532-6	761-0	136-43	544-6	760-1	130-07	550-3	763-2													
36	127-17	538-5	760-6	130-15	529-5	761-0	136-35	545-0	758-9	130-32	547-4	756-7													
42	127-07	541-0	763-5	130-40	528-7	759-2	136-22	544-8	758-9	130-36	547-4	751-1													
48	128-25	538-7	763-7	130-38	526-1	760-8	136-22	545-5	757-7	129-83	548-1	749-6													
54	127-83	539-3	765-1	130-42	527-9	757-1	136-22	547-7	759-5	130-13	549-5	747-4													
	19h.			23h.			3h.			7h.															
0	127-98	538-5	763-7	131-22	529-4	755-7	136-10	548-6	758-1	130-40	546-2	747-7													
6	127-30	536-8	764-8	131-65	528-5	755-6	135-90	549-1	757-9	130-02	543-4	751-8													
12	127-12	536-8	761-0	131-65	527-3	754-7	135-72	548-9	126-22	536-5	752-4													
18	127-70	535-1	763-1	131-65	529-9	753-4	135-68	548-5	759-9	122-58	545-0	753-4													
24	127-80	533-8	765-3	131-98	529-2	753-6	135-60	550-4	760-0	123-40	546-2	759-7													
30	127-40	533-7	765-9	132-37	528-8	753-1	135-39	548-4	759-3	123-91	547-8	761-3													
36	127-47	532-5	767-7	132-90	529-4	753-1	134-47	546-8	759-7	124-92	547-6	759-2													
42	126-79	532-6	768-0	133-42	530-2	752-3	134-28	547-9	760-3	126-03	546-3	755-8													
48	126-68	534-1	771-6	133-67	531-6	749-7	133-84	547-0	761-0	127-47	545-0	750-9													
54	126-25	535-6	773-5	134-28	530-1	752-5	133-57	547-3	761-6	127-14	545-7	748-6													
	20h.			0h.			4h.			8h.															
0	126-15	536-4	775-6	134-99	531-8	755-1	133-20	547-6	765-3	128-30	545-4	749-1													
6	126-13	536-5	775-3	135-43	532-9	754-8	133-08	548-7	766-3	128-07	543-1	747-2													
12	126-35	536-7	776-6	136-15	536-0	755-5	133-00	548-9	766-1	127-95	545-0	744-2													
18	125-83	536-5	775-8	137-02	536-0	756-3	132-93	548-3	769-6	127-83	541-2	744-4													
24	124-97	537-4	776-9	136-13	531-7	758-4	132-31	547-7	766-0	126-57	544-5	743-3													
30	124-62	536-7	778-8	136-10	530-5	760-3	132-10	548-4	762-6	126-94	549-9	743-5													
36	124-63	536-4	778-9	136-28	528-1	762-2	131-63	548-6	761-9	127-05	547-5	750-1													
42	124-72	537-0	781-8	136-88	529-3	763-4	131-55	549-7	760-2	127-55	543-2	753-8													
48	125-08	536-5	782-4	137-03	528-8	763-0	131-49	550-0	761-9	127-01	540-6	757-5													
54	124-72	537-7	781-8	136-43	530-1	759-7	131-47	550-8	763-1	126-97	539-9	756-9													
	21h.			1h.			5h.			9h.															
0	124-73	537-5	780-3	135-10	533-9	757-4	130-98	550-7	763-3	125-75	540-3	759-3													
6	124-57	536-8	780-3	135-30	535-6	757-5	130-98	550-4	764-4	124-99	541-0	764-5													
12	125-10	537-6	776-5	135-25	538-5	755-9	130-58	547-9	764-8	125-50	542-3	764-1													
18	125-02	537-3	776-9	135-55	539-0	756-4	130-25	548-7	763-9	126-28	541-4	761-1													
24	125-20	537-3	775-3	135-62	539-4	756-3	130-32	552-2	765-0	126-63	541-4	758-9													
30	125-00	535-9	774-3	135-73	539-6	756-4	130-35	552-1	766-7	126-92	540-5	758-5													
36	125-19	536-5	771-4	135-68	541-0	756-1	130-60	551-3	766-9	126-95	541-4	759-5													
42	125-10	535-9	771-7	135-82	542-5	756-1	130-78	547-9	767-5	127-12	543-7	756-8													
48	125-52	536-3	769-8	135-73	544-5	757-8	130-58	544-6	767-2	126-46	546-5	754-3													
54	126-33	536-0	770-9	136-13	545-6	759-2	129-96	546-9	766-9	126-40	546-8	760-2													
Hour,	18	19	20	21	22	23	0	1	2	3	4	5	6	7	8	9	10								
BIFILAR THERMOMETER,	48-8	48-8	49-1	49-8	50-8	50-7	50-9	52-6	53-0	54-4	54-7	54-9	54-9	55-2	54-6	54-1	54-9								
BALANCE THERMOMETER,	50-9	51-6	51-6	52-6	53-5	52-6	52-6	53-9	54-2	55-5	55-7	56-2	56-9	57-1	57-5	58-2	58-9								

Göttingen Mean Time of Declination Observation.	NOVEMBER 25, 26.															
	DECLINA- TION.	BIFILAR Corrected.	BALANCE Corrected.	DECLINA- TION.	BIFILAR Corrected.	BALANCE Corrected.	DECLINA- TION.	BIFILAR Corrected.	BALANCE Corrected.	DECLINA- TION.	BIFILAR Corrected.	BALANCE Corrected.				
	Min.	Sc. Div.	Mic. Div.	'	Sc. Div.	Mic. Div.	'	Sc. Div.	Mic. Div.	'	Sc. Div.	Mic. Div.				
	10 ^h .			14 ^h .			18 ^h .			22 ^h .						
0	126-22	549-9	737-1	127-50	547-4	710-1	126-62	546-3	708-9	128-83	542-7	721-9				
6	126-50	550-7	733-8	127-50	547-2	709-9	127-05	545-4	709-2	128-68	542-6	724-0				
12	127-00	550-7	729-4	127-54	546-2	710-2	127-14	545-5	708-9	129-01	537-0	724-0				
18	127-48	548-8	726-9	127-50	546-2	709-2	127-27	545-8	710-8	129-08	542-1	724-1				
24	127-28	547-5	724-7	127-48	546-0	708-6	127-23	546-1	711-6	129-07	541-9	723-6				
30	127-25	547-8	722-2	127-38	545-5	708-8	127-34	546-4	710-8	129-23	542-4	723-9				
36	127-63	548-6	721-4	127-43	545-8	708-7	127-52	547-0	710-3	129-65	543-3	722-1				
42	127-72	549-0	720-1	127-50	546-2	709-2	127-50	546-5	710-2	129-73	543-5	722-4				
48	127-57	548-3	718-5	127-45	546-2	710-1	127-32	546-9	711-4	129-75	544-1	721-2				
54	127-43	548-4	717-2	127-61	546-2	711-7	127-32	546-0	712-8	130-00	545-0	722-0				
	11 ^h .			15 ^h .			19 ^h .			23 ^h .						
0	127-50	548-9	716-2	128-00	546-3	716-3	127-28	546-0	705-1	129-90	543-6	722-2				
6	127-50	549-0	714-0	129-43	546-3	718-9	127-21	546-8	705-7	129-69	544-2	721-4				
12	127-38	548-8	714-0	129-53	546-7	719-7	127-08	547-7	705-8	129-34	544-0	720-6				
18	127-23	548-8	713-0	129-47	547-3	718-8	127-47	547-2	705-0	129-32	544-0	720-4				
24	127-07	549-0	712-9	129-12	548-6	716-6	127-08	548-6	712-7	129-15	544-1	720-6				
30	127-23	548-4	713-4	128-85	550-4	715-1	127-50	548-1	712-4	129-14	544-5	721-1				
36	127-50	548-3	712-7	128-41	551-7	712-0	127-18	548-9	712-0	129-32	544-6	720-8				
42	127-50	547-8	712-4	127-81	552-2	710-0	127-27	548-3	712-4	129-58	545-1	721-0				
48	127-37	547-8	712-6	127-48	551-2	708-2	127-54	546-4	713-2	129-83	545-1	720-9				
54	127-50	547-8	711-9	127-32	550-5	708-6	127-74	547-9	712-4	130-13	545-1	721-5				
	12 ^h .			16 ^h .			20 ^h .			0 ^h .						
0	127-40	547-5	711-2	127-48	549-7	705-4	127-57	548-4	713-3	130-25	545-3	722-3				
6	127-50	547-9	710-9	127-47	549-7	704-0	127-70	548-8	716-4	130-73	546-0	721-4				
12	127-57	547-9	709-4	127-61	549-6	702-6	127-70	549-2	719-3	130-83	546-0	718-7				
18	127-50	547-9	709-3	127-74	549-0	700-6	127-70	548-6	718-9	131-18	545-9	719-5				
24	127-60	547-6	710-6	128-14	549-0	699-5	127-77	550-4	717-8	130-95	544-8	720-3				
30	127-50	547-6	711-1	128-28	549-3	697-9	127-74	550-5	716-0	130-87	544-9	719-9				
36	127-50	547-6	710-9	127-67	549-3	696-4	127-98	550-0	713-0	130-70	545-2	720-3				
42	127-40	547-3	711-5	127-05	550-0	694-5	127-97	549-0	711-4	130-98	545-7	719-5				
48	127-50	547-8	711-2	126-45	549-7	694-3	128-23	549-6	710-7	131-10	544-7	721-8				
54	127-21	547-9	712-1	126-25	549-4	694-9	128-12	550-5	711-8	131-00	545-0	722-3				
	13 ^h .			17 ^h .			21 ^h .			1 ^h .						
0	127-50	547-7	713-1	126-23	549-1	695-3	128-17	549-8	711-2	131-05	544-5	720-9				
6	127-50	547-0	712-1	126-32	548-5	696-2	128-23	549-1	711-0	130-98	545-8	722-9				
12	127-50	546-9	711-7	126-32	547-7	697-1	128-28	548-3	711-5	131-60	548-3	724-5				
18	127-50	547-1	711-8	126-65	547-5	697-8	128-52	548-0	715-3	130-95	546-7	723-5				
24	127-50	546-6	711-7	126-79	547-2	698-8	128-45	546-3	716-3	131-69	546-4	727-3				
30	127-50	546-6	712-0	126-92	547-0	700-7	128-41	545-7	717-1	131-25	545-4	727-1				
36	127-50	546-5	712-0	127-00	546-7	703-0	128-38	545-1	719-3	131-62	546-5	729-0				
42	127-58	547-2	710-9	127-08	546-2	705-5	128-57	543-3	719-4	131-70	546-6	727-5				
48	127-52	546-8	711-1	127-08	546-0	707-0	128-68	542-3	720-7	131-65	545-5	727-5				
54	127-50	547-2	710-0	126-97	546-1	707-2	128-45	543-0	722-4	131-09	544-6	728-1				
Hour,	10	11	12	13	14	15	16	17	18	19	20	21	22	23	0	1
BIFILAR THERMOMETER, .	53-0	55-4	56-0	56-2	56-1	56-0	57-9	57-4	56-4	55-8	56-3	58-3	57-8	57-5	57-1	56-9
BALANCE THERMOMETER, .	53-0	55-3	55-8	56-2	56-4	56-6	59-0	58-4	57-3	57-1	57-9	60-0	59-7	59-2	59-0	59-1

Göttingen Mean Time of Declination Observation.	NOVEMBER 25, 26.						DECEMBER 20, 21.										
	DECLINA- TION.	BIFILAR Corrected.	BALANCE Corrected.	DECLINA- TION.	BIFILAR Corrected.	BALANCE Corrected.	DECLINA- TION.	BIFILAR Corrected.	BALANCE Corrected.	DECLINA- TION.	BIFILAR Corrected.	BALANCE Corrected.					
	Min.	Sc. Div.	Mic. Div.	'	Sc. Div.	Mic. Div.	'	Sc. Div.	Mic. Div.	'	Sc. Div.	Mic. Div.					
	2h.			6h.			10h.			14h.							
0	131-23	546-5	730-0	128-28	552-4	716-6	122-40	548-5	705-3	125-42	548-1	680-2					
6	131-12	546-2	731-0	128-25	552-5	715-8	123-13	548-4	703-9	125-28	547-7	680-1					
12	131-07	547-0	732-1	128-35	551-7	717-6	123-47	549-3	701-3	125-02	547-1	678-5					
18	131-32	547-9	731-6	128-45	551-1	717-6	124-05	548-0	700-4	125-40	546-8	680-1					
24	131-18	547-0	731-5	128-28	551-5	716-8	124-13	548-0	697-7	125-63	547-2	678-6					
30	130-98	547-7	729-4	128-34	551-2	716-1	124-53	548-4	696-5	126-15	546-8	680-5					
36	130-98	547-9	729-4	128-27	551-1	716-2	124-40	547-4	693-7	126-77	546-9	680-1					
42	130-98	549-4	728-9	128-05	550-9	716-2	124-08	548-2	693-0	127-54	546-0	680-5					
48	131-16	550-1	728-4	127-90	550-4	716-4	124-39	548-0	690-5	127-63	546-5	679-4					
54	131-12	549-7	727-8	127-58	551-4	716-1	124-07	549-1	688-6	126-98	547-1	677-7					
	3h.			7h.			11h.			15h.							
0	131-00	549-9	727-0	127-78	550-7	715-5	123-97	549-7	687-5	126-28	548-0	678-2					
6	130-98	549-7	727-3	128-27	550-6	715-8	123-91	549-2	685-7	126-05	548-0	678-4					
12	130-98	550-2	727-4	128-12	549-3	715-2	123-84	550-0	685-5	125-95	547-0	680-0					
18	130-98	550-4	727-7	128-17	549-2	714-2	124-53	548-9	683-6	125-68	546-2	679-2					
24	130-98	550-5	727-5	128-18	549-1	713-9	124-39	548-4	682-4	125-50	546-0	679-4					
30	130-82	549-3	727-0	127-95	549-3	714-9	124-73	549-4	681-9	125-02	545-6	678-9					
36	130-85	550-2	725-9	128-01	549-0	715-2	125-19	549-1	680-8	124-79	546-2	679-3					
42	130-83	550-4	724-7	128-27	548-5	714-9	125-70	548-7	681-1	124-52	546-4	680-6					
48	130-35	550-7	724-0	127-98	548-3	713-9	125-93	549-5	681-8	124-73	545-9	681-0					
54	130-35	548-3	723-8	127-65	548-3	713-7	125-72	548-3	680-8	124-45	547-0	681-3					
	4h.			8h.			12h.			16h.							
0	130-49	549-8	721-1	127-54	548-4	712-9	125-45	548-9	681-0	124-68	547-4	681-1					
6	130-49	550-3	720-4	127-10	548-4	712-2	125-26	549-3	679-9	125-02	548-3	682-1					
12	130-36	550-1	720-3	127-07	548-3	712-8	125-50	550-6	679-7	125-02	546-8	681-6					
18	129-92	550-1	721-9	127-50	547-4	712-0	126-37	552-4	677-9	124-83	546-7	682-7					
24	129-49	550-8	721-8	127-28	547-7	712-3	126-19	552-5	676-3	125-20	547-0	683-9					
30	129-58	550-7	721-7	127-17	546-5	711-6	125-70	550-2	675-9	125-82	547-3	686-4					
36	129-28	550-6	721-8	126-40	546-6	711-5	125-45	549-3	676-0	126-22	549-3	685-4					
42	129-17	551-2	719-2	126-39	548-2	711-1	125-48	548-7	677-6	126-57	547-5	684-7					
48	129-14	551-3	721-0	126-90	547-1	712-6	125-62	548-5	677-6	127-03	547-3	684-1					
54	129-35	551-5	719-3	127-41	546-1	712-9	125-85	548-5	677-6	127-00	547-6	682-8					
	5h.			9h.			13h.			17h.							
0	128-90	549-5	719-7	127-23	545-9	713-7	126-08	548-4	677-6	126-90	547-9	679-8					
6	129-17	548-0	719-2	127-12	547-0	716-3	126-32	548-4	677-7	126-59	547-6	678-6					
12	128-58	546-1	720-8	126-90	546-3	716-8	126-28	548-3	679-5	126-15	547-3	676-0					
18	127-68	546-4	720-3	126-82	546-1	718-0	125-65	549-0	679-0	126-48	546-8	675-3					
24	126-98	547-3	722-6	126-82	546-7	718-8	126-19	549-6	676-1	126-62	547-0	674-4					
30	126-68	548-7	722-0	126-82	546-8	720-2	126-28	550-1	677-6	126-28	547-1	675-1					
36	126-80	550-4	719-7	126-79	546-7	719-2	125-82	548-7	678-8	126-08	547-4	675-6					
42	127-43	550-2	719-0	126-90	546-5	719-8	125-72	549-1	678-0	126-32	547-0	673-4					
48	127-45	552-5	718-1	127-03	546-0	720-1	125-70	548-4	678-3	126-66	546-9	676-9					
54	127-88	552-8	716-4	127-27	545-8	719-7	125-43	546-9	679-5	126-42	547-1	677-3					
Hour,	2	3	4	5	6	7	8	9	10	10	11	12	13	14	15	16	17
BIFILAR THERMOMETER,	56-9	57-9	59-0	59-6	59-8	59-8	59-5	58-6	58-4	60-6	61-8	62-7	62-7	62-6	62-2	61-4	60-7
BALANCE THERMOMETER,	58-9	60-2	61-2	61-3	61-7	61-5	61-2	60-6	59-7	62-2	63-5	64-2	64-2	64-0	63-6	62-9	62-2

Göttingen Mean Time of Declination Observation.		DECEMBER 20, 21.																
		18 ^{h.}			22 ^{h.}			2 ^{h.}			6 ^{h.}							
		DECLINA- TION.	BIFILAR Corrected.	BALANCE Corrected.	DECLINA- TION.	BIFILAR Corrected.	BALANCE Corrected.	DECLINA- TION.	BIFILAR Corrected.	BALANCE Corrected.	DECLINA- TION.	BIFILAR Corrected.	BALANCE Corrected.					
Min.	Sc. Div.	Mic. Div.	Sc. Div.	Mic. Div.	Sc. Div.	Mic. Div.	Sc. Div.	Mic. Div.	Sc. Div.	Mic. Div.	Sc. Div.	Mic. Div.						
0	126.19	547.8	675.5	129.98	551.5	672.4	129.03	548.3	704.9	127.65	550.3	697.2						
6	125.93	548.3	675.6	129.63	550.1	670.7	128.97	548.9	705.4	127.74	550.1	697.8						
12	125.80	548.4	675.9	129.34	549.7	663.9	128.74	548.5	705.4	127.63	551.4	694.5						
18	125.70	549.3	676.4	129.52	548.9	664.2	128.37	548.3	705.3	127.60	550.8	695.2						
24	125.50	548.8	678.5	129.41	548.6	662.6	128.18	548.4	705.8	127.55	550.5	695.7						
30	125.57	549.4	684.7	129.63	547.6	671.6	128.10	548.3	706.3	127.43	549.8	695.7						
36	126.10	549.4	689.1	129.53	548.0	672.4	127.78	548.7	706.5	127.47	548.9	695.9						
42	126.13	549.2	691.9	129.27	546.7	673.0	127.77	548.3	706.6	127.08	550.1	695.4						
48	126.05	550.3	692.3	129.37	547.2	673.3	127.63	548.3	707.6	127.00	550.3	697.0						
54	125.86	551.4	690.7	129.34	547.7	673.4	127.52	548.8	707.6	127.00	550.2	695.8						
		19 ^{h.}			23 ^{h.}			3 ^{h.}			7 ^{h.}							
0	126.35	551.0	691.1	129.52	547.5	674.7	127.50	547.9	708.0	126.94	551.6	694.4						
6	126.06	551.9	690.5	129.55	547.4	677.6	127.17	547.9	707.6	127.05	552.2	692.8						
12	126.45	551.7	690.7	129.69	546.8	684.3	127.10	548.4	708.0	126.88	550.2	694.9						
18	126.33	551.3	691.0	129.83	546.5	687.0	127.30	548.4	707.9	126.68	549.7	695.3						
24	126.70	551.2	691.1	129.83	546.6	687.9	127.30	548.0	708.4	126.55	549.6	692.8						
30	126.79	550.5	690.8	129.69	547.8	687.9	127.10	547.9	708.3	126.79	549.7	697.9						
36	126.90	550.0	690.0	129.70	547.0	688.1	127.27	548.5	708.3	126.75	549.4	697.8						
42	126.82	550.2	691.2	129.62	546.0	688.6	127.50	548.0	709.8	126.79	549.7	697.7						
48	126.92	549.9	691.4	129.72	546.6	687.5	127.55	548.1	711.2	126.97	549.8	698.7						
54	126.90	549.2	692.5	129.49	546.3	686.4	127.63	547.0	710.6	126.90	550.6	696.0						
		20 ^{h.}			0 ^{h.}			4 ^{h.}			8 ^{h.}							
0	126.90	548.8	693.3	129.52	546.1	685.7	127.74	547.0	709.3	126.95	551.8	696.8						
6	126.98	548.0	693.5	129.78	547.0	685.8	127.83	546.8	708.1	126.87	551.5	696.4						
12	127.30	547.0	693.5	129.75	546.9	685.9	127.63	547.5	708.1	126.53	551.8	697.6						
18	127.63	546.7	693.0	129.93	547.1	686.6	127.57	547.9	707.3	125.79	549.9	697.5						
24	127.90	546.2	692.7	130.32	547.7	686.9	127.50	548.5	707.5	125.48	549.9	698.0						
30	128.70	544.8	692.6	130.60	548.4	687.7	127.60	548.9	706.9	127.77	549.6	697.7						
36	129.01	544.9	690.5	130.93	548.8	688.0	127.50	549.6	707.3	125.97	548.5	697.9						
42	129.32	545.0	688.6	130.65	547.9	688.1	127.67	548.6	708.0	125.22	548.2	696.5						
48	129.63	544.8	687.5	130.36	547.6	687.5	127.61	548.8	708.5	124.30	548.4	696.1						
54	129.80	544.6	685.4	130.15	547.6	686.3	127.63	547.8	709.0	124.27	549.3	695.9						
		21 ^{h.}			1 ^{h.}			5 ^{h.}			9 ^{h.}							
0	130.05	544.9	684.8	129.72	547.4	687.5	128.28	548.3	707.4	124.57	549.8	696.7						
6	130.25	544.7	882.4	129.76	548.0	688.6	127.87	549.0	706.3	125.42	550.7	697.1						
12	130.05	545.6	680.5	129.53	548.3	688.6	127.98	549.7	704.5	125.72	551.5	698.8						
18	129.67	546.1	679.5	129.47	548.0	691.6	127.63	549.1	702.8	125.93	548.9	700.0						
24	129.62	547.9	678.0	129.30	548.3	693.6	127.63	549.9	703.0	125.66	548.9	698.8						
30	129.43	549.6	676.8	129.25	548.2	697.2	127.50	551.8	700.9	125.68	549.5	698.3						
36	129.53	550.3	676.4	129.34	548.4	699.4	127.17	551.6	701.1	126.03	549.7	698.3						
42	129.62	550.5	676.3	129.47	548.4	701.1	127.23	552.6	700.3	126.19	549.5	698.2						
48	129.63	551.2	675.4	129.10	547.8	702.5	127.03	552.2	700.4	125.93	549.4	696.7						
54	130.22	551.1	674.8	129.10	547.9	703.9	127.63	550.7	701.3	125.79	549.6	696.7						
Hour,		18	19	20	21	22	23	0	1	2	3	4	5	6	7	8	9	10
BIFILAR THERMOMETER,		59.8	59.8	59.9	59.9	59.8	58.7	58.7	58.6	58.4	58.4	58.6	58.8	59.4	59.8	59.8	59.2	58.8
BALANCE THERMOMETER,		61.3	61.5	62.2	62.2	61.7	60.3	60.7	60.3	60.3	60.2	60.3	60.7	61.2	61.3	61.7	60.9	60.6

EXTRA OBSERVATIONS

OF

MAGNETOMETERS.

1841 AND 1842.

EXTRA OBSERVATIONS OF MAGNETOMETERS, 1841.

AUGUST 20.				SEPTEMBER 25.				SEPTEMBER 25.									
Göttingen Mean Time of Observation.		DECLINATION.	BIFILAR Cor-rected.	BALANCE Cor-rected.	Göttingen Mean Time of Observation.		DECLINATION.	BIFILAR Cor-rected.	BALANCE Cor-rected.	Göttingen Mean Time of Observation.		DECLINATION.	BIFILAR Cor-rected.	BALANCE Cor-rected.			
d.	h.	m.	s.	Sec. Div.	Mic. Div.	d.	h.	m.	s.	Sec. Div.	Mic. Div.	d.	h.	m.	s.	Sec. Div.	Mic. Div.
20	22	40	0	135.28	531.0	25	4	46	30		909	25	5	53	30	655.2	
		45	0	135.82				48	30	764.7				55	0	147.23	
		50	0	136.02	531.5			50	0	141.87				56	30		666
		55	0	136.30				51	30		1032			58	30	702.9	
23	0	0	0	136.97	533.8			53	5	812.0			6	0	0	164.14	
		5	0	137.17				30		822.6				1	30		619
		10	0	137.83	532.5			55		829.0				3	30	783.5	
		15	0	138.10				55	0	121.40				5	0	188.98	
		20	0	138.30	693			56	30		910			6	30		823
								58	5	849.7				8	30	794.9	
								30		854.6				10	0	190.50	
								55		861.0				11	30		1007
								5	0	0	130.45			13	30	760.3	
								1	30		802			15	0	141.12	
								3	5	875.1				16	30		689
								30		861.1				18	5	834.2	
								55		843.6				30		824.8	
								5	0	135.42				55		809.8	
								6	30		823			19	42	194.20	
								8	30	779.7				20	0	213.43	
								9	42	142.20				20	18	221.56	
								10	0	152.54				21	30		781
								10	18	154.80				23	30	592.6	
								11	30		898			25	0	205.27	
								13	30	757.0				26	30		1000
								15	0	142.73				28	30	620.3	
								16	30		1005			30	0	182.91	
								18	30	690.5				31	30	660.7	
								20	0	138.30				33	30		
								21	30		907			35	0	199.70	
								23	30	705.7				36	30		682
								25	0	149.36				38	30	637.0	
								26	30		907			40	0	204.40	
								28	30	676.9				41	30		841
								30	0	139.52				43	5	693.0	
								31	30		894			30		680.7	
								33	30	690.2				55		667.4	
								34	42	139.05				45	0	189.03	
								35	0	130.32				46	30		943
								35	18	121.07				48	5	604.1	
								36	30		847			30		615.5	
								38	30	793.2				55		620.2	
								39	42	180.65				50	0	182.25	
								40	0	184.00				51	30		878
								40	18	158.90				53	5	643.3	
								41	30		827			30		649.4	
								43	30	795.0				55		659.6	
								45	0	171.42				55	0	178.90	
								46	30		695			56	30		763
								48	30	620.0?				58	5	622.8	
								50	0	131.60				30		617.8	
								51	30		838			55		606.0	

Aug. 20^d 22^h 1841. Observations made during a thunder-storm. 22^h 50^m. Very heavy rain. 23^h 15^m. Clearing off. 23^h. Thermometers, Bifilar, 60°·4; Balance, 61°·0. The times of the Bifilar and Balance observations are 2^m 30^s after those in the first column.

From the above it would not appear that the mean directions of the magnets were affected by the thunder-storm; the vibrations of the Declination magnet were occasionally very considerable, and this appeared particularly the case when the fall of rain was unusually heavy;—thus, at 22^h 50^m, when the rain was exceedingly violent, the arc of vibration amounted to about 17', while at 22^h 45^m, when the fall was comparatively slight, the arc of vibration did not exceed 3'. E. R.

Sept. 25^d 4^h 1841. When the scale of the Bifilar Magnetometer went or was going out of the field of the reading telescope, Mr Russell turned the torsion circle so as to bring the scale into the field again; the following were the readings of the torsion circle at the times annexed:—2^h 2^m 30^s, 114°, usual position; 4^h 0^m, 108°; 5^h 20^m, 110°; 5^h 25^m, 111°; 5^h 40^m, 109°; 5^h 50^m, 111°; 6^h 25^m, 112°. The reading of the Bifilar scale was estimated at the following times, the scale being in sight, but beyond the vertical wire of the reading telescope; 2^h 2^m 30^s, 5^h 18^m 30^s, 6^h 25^m 30^s. At 5^h 48^m 30^s the scale was out of sight, so that the reading must have been less than is here noted.

The observations of the Bifilar Magnetometer are reduced to the torsion circle reading 114°. See Introduction.

Sept. 25^d 1841. Bifilar Thermometer, 2^h, 62°·0; 4^h, 65°·1; 5^h, 65°·0; 6^h, 64°·9; 7^h, 64°·2.
Balance Thermometer, 2^h, 60°·2; 4^h, 63°·2; 5^h, 63°·2; 6^h, 63°·2; 7^h, 63°·2.

Göttingen Mean Time.			DECLINATION.		BIFILAR.		BALANCE.		Göttingen Mean Time.			DECLINATION.		BIFILAR.		BALANCE.	
			Min. of Obs.	Reading Reduced.	Min. of Obs.	Reading Cor-rected.	Min. of Obs.	Reading Cor-rected.				Min. of Obs.	Reading Cor-rected.	Min. of Obs.	Reading Reduced.	Min. of Obs.	Reading Cor-rected.
May 16	d. 4	h. 4	m.		m.	Sc. Div.	m.	Mic. Div.	May 25	d. 5	h. 5	m.		m.	Sc. Div.	m.	Mic. Div.
May 16	16	5	0	149.71	2	574.3	58	998	27			132.13	26	557.3			
			13	144.42	15	554.3	14	1055					29	554.8			
			16	141.93	18	549.1	17	1069					30	556.6			
			19	139.72	21	546.7	20	1072					34	553.6			
			22	139.38	24	544.9	23	1077	July 1	19							
			25	137.37	27	549.4	26	1074	July 1	20	0	126.42	2	479.8	58	618	
			28	134.53	30	551.5	29	1056			6	118.63	7	495.2	9	634	
			31	134.60	33	552.3	32	1042			10	122.33	11	513.5	12	634	
			34	134.82	36	554.9	35	1031			13	125.22	14	517.3	15	635	
			37	134.88	39	553.3	38	1022			16	125.48	17	507.2			
			40	135.22	42	552.9	41	1015			18	123.40	19	488.2	20	655	
			43	135.55	45	555.4	44	1008			21	122.73	22	472.4	23	666	
			46	135.55	48	556.6	47	1003			24	121.52	25	456.1	26	678	
			49	135.82	51	553.6	50	999			27	120.12	28	462.6	29	670	
			52	135.15	54	555.1	53	995						(464.3)			
			55	134.33	57	555.4	56	989			30	119.85	31	473.1	32	661	
			58	134.33	60	554.8	59	984						(474.8)			
May 16	16	6	1	134.20	3	556.0	2	980			33	119.18	34	491.5	35	655	
			4	134.13	6	558.3	5	975			36	117.37	37	499.6	38	654	
			7	135.08	9	558.9	8	970						(503.3)			
			10	135.62	12	559.8	11	967			39	113.93	40	509.1	41	651	
			13	136.68	15	560.3	14	964						(506.4)			
			16	136.88	18	558.3	17	962			42	106.55	43	489.1	44	672	
			19	137.37	21	557.3	20	960						(487.5)			
			22	137.30	26	555.4	24	958			45	120.45	46	485.1	47	698	
			28	137.57	31	550.7	29	957						(484.5)			
			33	137.15	39	548.0	36	951			48	128.03	49	467.8	50	701	
			42	136.02	48	548.5	45	941			51	119.45			52	703	
			51	136.02	57	556.1	54	932			54	126.15	55	464.8	56	716	
May 16	16	7	0	136.35	6	555.5	3	928	July 1	21	0	130.78	1	443.6	2	720	
			9	136.35	15	556.9	12	922						(445.1)			
			18	137.50			28	920			3	124.07	4	435.7	5	714	
					40	549.0								(430.2)			
May 24	24	7	30	130.65	32	549.6	34	839			6	111.53	7	432.1	8	708	
May 24	24	8	0	130.45	2	550.1	4	839						(433.6)			
May 25	25	2	54	135.28	55	546.0	56	823			9	110.12	10	455.6	11	707	
			57	135.62	58	545.9	59	821						(456.6)			
May 25	25	3	0	135.02	1	547.3	2	819			12	116.83	13	461.3	14	710	
			3	135.02	4	549.0	5	819			15	114.42	16	439.5	17	718	
			6	134.82	7	547.9								(436.3)			
					11	549.9					18	115.35	19	460.5	20	733	
					13	546.9								(462.7)			
					16	544.7					21	131.25	22	478.3	23	726	
					20	549.3								(127.17)			
			26	134.33	24	548.8	25	816			24	127.97	25	481.0	26	720	
														(483.2)			

Bifilar Thermometer. May 16^d 5^h 1842, 67°0; 6^h, 67°7; 7^h, 67°9. May 24^d 7^h 30^m, 58°0. May 25^d 3^h, 59°5; 5^h, 61°1. July 1^d 20^h, 58°4; 21^h, 58°0.

Balance Thermometer. May 16^d 5^h, 64°7; 6^h, 65°3; 7^h, 65°7. May 24^d 7^h 30^m, 56°7. May 25^d 3^h, 58°1. July 1^d 20^h, 58°7; 21^h, 58°4.

Arcs of Vibration. Declination Magnet. July 1^d 20^h 0^m, 11'; 20^h 6^m, 7'; 20^h 13^m, 8'; 20^h 16^m, 15'; 20^h 18^m, 17'; 20^h 21^m, 11'; 20^h 24^m, 10'; 20^h 27^m, 7'. Bifilar Magnet. July 1^d 20^h 2^m, (22^{div} up); 21^h 4^m, 14^{div}; 21^h 7^m, 13^{div}.

The arcs of vibration given above are taken from the readings as registered, and are therefore generally less than the truth; in a few cases the arc was noted at the time of observation. The arc has not been given excepting when the difference of two consecutive readings exceeds 6' for the Declination and 10' for the Bifilar. When the readings of the bifilar do not shew a vibration but a progressive motion, the quantity moved in 50^s is given in brackets with up or down attached as the reading was increasing or diminishing.

July 1^d—4^d. When an observation of the Bifilar is given in brackets (), it is the mean position 25^s after the previous observation; an extra reading having been made at 50^s, it is the mean of the readings at 0^s, 25^s, and 50^s. The observations of Declination in brackets are the mean positions 18^s before the succeeding observation, obtained by making a reading 36^s before the minute. 25^s and 18^s being the times of vibration of the Bifilar and Declination magnets respectively.

EXTRA OBSERVATIONS OF MAGNETOMETERS, JULY 1, 2, 1842.

Göttingen Mean Time.			DECLINATION.		BIFILAR.		BALANCE.		Göttingen Mean Time.			DECLINATION.		BIFILAR.		BALANCE.		
			Min. of Obs.	Reading Reduced.	Min. of Obs.	Reading Cor-rected.	Min. of Obs.	Reading Cor-rected.				Min. of Obs.	Reading Cor-rected.	Min. of Obs.	Reading Reduced.	Min. of Obs.	Reading Cor-rected.	Min. of Obs.
July	d.	h.	m.	'	m.	Sc. Div.	m.	Mic. Div.	July	d.	h.	m.	'	m.	Sc. Div.	m.	Mic. Div.	
			27	124.88	28	489.1	29	712				9	129.23	10	487.9	11	746	
			30	120.05	31	464.6	32	717										
			33	117.97	34	471.9	35	719		12	134.27	13	493.8	14	748			
			36	122.00	37	465.4	38	730		15	134.95	16	492.9	17	750			
			39	125.35	40	472.4	41	732		18	135.42	19	501.6	20	752			
				(128.70)						21	137.77	22	510.9	23	746			
			42	129.72	43	463.9	44	735		24	137.97	25	511.8	26	744			
						(462.6)				27	137.30	28	523.5	29	733			
			45	126.55	46	464.0	47	738		30	137.57	31	536.3	32	721			
						(467.0)				33	136.08	34	537.4	35	723			
			48	133.13	49	484.2	50	733		36	136.82	37	533.5	38	728			
						(485.8)						39	527.0					
			51	140.05	52	495.5	53	727		42	131.45	43	524.9	44	721			
			54	143.95	55	503.8	56	721					(527.8)					
						(501.8)				45	130.65	46	523.6	47	728			
			57	145.50	58	498.2	59	726		48	131.52	49	515.8	50	732			
						(495.5)				51	128.10	52	521.8	53	732			
July	1	22	0	145.30	1	489.0	2	718		54	128.43	55	524.0	56	737			
			3	137.37	4	491.8	5	712					(522.6)					
						(494.0)				57	128.70	58	516.8	59	744			
			6	135.35	7	497.1	8	715		0	124.75	1	509.0	2	756			
						(500.6)							(510.0)					
			9	138.23	10	513.2	11	718		3	123.00	4	522.2	5	755			
						(513.8)				6	123.07	7	530.3	8	761			
			12	139.25	13	514.9	14	711	July	2	0		(535.7)					
						(504.8)						9	535.5	11	771			
			15	128.70	16	502.6	17	714		12	116.35	13	537.3	14	779			
						(494.3)				15	113.93	16	540.0	17	793			
			18	126.42	19	494.3	20	724					(544.6)					
			21	129.17	22	485.3	23	731		18	114.20	19	547.3	20	804			
						(483.9)				21	113.20	22	541.0	23	820			
			24	129.85	25	489.3	26	726		24	119.52	25	544.6	26	835			
						(490.6)				27	130.38	28	571.6	29	842			
			27	125.75	28	489.4	29	724		30	136.62	31	584.5	32	857			
						(495.9)				33	134.47	34	576.5	35	907			
			30	130.38	31	501.4	32	722		36	148.44	37	559.1	38	977			
						(499.1)				39	141.13	40	544.4	41	1024			
			33	130.18	34	507.6	35	716		42	135.88	43	547.0	44	1044			
						(511.7)				45	133.33	46	554.3	47	1068			
			36	132.05	37	516.9	38	714					(557.0)					
						(519.1)				48	128.63	49	563.7	50	1109			
			39	134.00	40	520.7	41	710		51	130.58	52	557.3	53	1124			
			42	131.52	43	511.8	44	713					(566.9)					
						(510.6)				54	131.65	55	542.5	56	1118			
			45	127.23	46	501.8	47	719		57	128.17	58	543.8	59	1096			
			48	129.98	49	503.2	50	727					(553.3)					
						(501.7)				0	126.28	1	546.9	2	1079			
			51	132.73	52	497.4	53	728										
						(498.9)												
			54	131.98	55	509.2	56	729										
			57	133.67	58	505.1	58	732										
							59	730										
July	1	23	0	130.67	1	502.1	2	729										
			3	130.52	4	496.4	5	736										
						(493.2)												
			6	130.18	7	485.5	8	740										
						(483.1)												

Bifilar Thermometer. July 1^d 22^h, 58° 0'; 23^h, 58° 4'; 2^d 0^h, 58° 9'; 1^h, 59° 7'.

Balance Thermometer. July 1^d 22^h, 58° 4'; 23^h, 58° 5'; 2^d 0^h, 59° 0'; 1^h, 59° 7'.

Arcs of Vibration. Declination Magnet. July 1^d 21^h 45^m, 6'; 21^h 51^m, 6'; 2^d 0^h 33^m, 15'. Bifilar Magnet, July 1^d 22^h 7^m, 12^{div}; 22^h 16^m, 11^{div}; 2^d 0^h 7^m (17^{div} up).

See note, page 51, on the observations in brackets.

Göttingen Mean Time.			DECLINATION.		BIFILAR.		BALANCE.		Göttingen Mean Time.			DECLINATION.		BIFILAR.		BALANCE.	
			Min. of Obs.	Reading Reduced.	Min. of Obs.	Reading Cor-rected.	Min. of Obs.	Reading Cor-rected.				Min. of Obs.	Reading Cor-rected.	Min. of Obs.	Reading Reduced.	Min. of Obs.	Reading Cor-rected.
July	d. 2	h. 1	m. 3	124.42	m. 4	Sc. Div. 546.5 (548.9)	m. 5	Mic. Div. 1060	July	d. 2	h. 2	m. 57	137.50	m. 58	Sc. Div. 523.4	m. 59	Mic. Div. 802
			6	123.67	7	557.1 (558.1)	8	1040	July	2	3	0		1	529.5	2	798
			9	123.93	10	560.2 (562.3)	11	1020				3	138.92	4	536.2 (537.4)	5	796
			12	126.08	13	570.1 (571.7)	14	995						6	535.0		
			15	128.37	16	571.6	17	978						7	539.7		
			18	129.03	19	573.5 (576.5)	20	956				30	138.85	8	540.2	29	776
			21	129.37	22	569.6 (562.6)	23	950						28	559.8 (561.3)		
			24	131.18	25	582.4 (585.5)	26	925				30	138.85	31	557.4 (554.7)	32	784
			27	130.05	28	552.8	29	921				35	137.77	33	550.3		
			30	129.52	31	567.5 (565.8)	32	906	July	2	4	54	135.15	50	495.2	52	825
			33	131.32	34	575.7 (567.9)	35	895				0	135.82	56	517.1	58	822
			36	131.72	37	573.3 (574.5)	38	871				6	132.27	2	527.2	4	819
			39	132.67	40	572.3 (574.1)	41	856				12	132.87	8	536.3	10	808
			42	133.27	43	568.1	44	847				24	133.07	14	538.4	16	809
			45	133.67	46	570.3 (572.4)	47	832				30	133.80	20	537.8	22	806
			48	136.55	49	574.1 (571.5)	50	813	July	2	5	36	133.73	26	541.1	28	806
			51	136.68	52	564.6 (561.3)	53	810				42	134.95	32	563.5	34	796
			54	137.37	55	556.5 (554.5)	56	806				48	133.53	38	546.7	40	800
			57	136.68	58	542.9	58	810				54	134.13	44	552.1	46	795
July	2	2	0	138.03	1	542.4 (533.8)	2	814				0	137.43	50	535.8	52	804
			3	138.37	4	538.8 (542.2)	5	798				6	137.57	56	557.5	58	799
			6	142.28	7	529.7 (522.1)	8	809				12	137.23	2	559.2	4	811
			9	135.88	10	502.4 (508.3)	11	815				18	127.15	8	586.4	10	801
					12	516.4	14	813						14	589.8	16	825
					13	510.1	17	806						19	606.6		
			15	140.18	16	516.8	20	794						20	609.9		
			18	140.72	19	525.0 (526.6)								21	615.8	22	842
					21	529.0	23	797						22	622.0		
			24	141.05	25	540.5 (538.0)	26	797				24	136.22	23	624.9		
			27	138.72	28	531.7 (532.8)	29	794						24	625.2	22	842
					30	538.6	32	790						25	626.0		
			33	139.05	34	532.7 (536.2)	35	795						26	620.6	28	875
														29	622.4	31	889
														32	621.1	34	904
														35	623.0	37	914
														38	626.4	40	922
														41	625.7 (623.5)	43	927
														44	615.0	46	933
														47	609.4 (607.5)	49	943
														50	606.0		
														51	606.1	52	947
														54	605.8	55	950
														56	605.8		
														57	603.7 (602.7)	58	955
														0	589.4 (588.3)	1	961
														2	590.2 (588.7)	4	965
														5	579.1		

Bifilar Thermometer. July 2^d 2^h, 60°0; 3^h, 60°5; 5^h, 61°6; 6^h, 61°8.
 Balance Thermometer. July 2^d 2^h, 59°9; 3^h, 60°2; 5^h, 61°2; 6^h, 61°4.
 Arcs of Vibration. Bifilar Magnet. July 2^d 2^h 7^m, 28^{div}.
 See note, page 51, on the observations in brackets.

Göttingen Mean Time.			DECLINATION.		BIFILAR.		BALANCE.		Göttingen Mean Time.			DECLINATION.		BIFILAR.		BALANCE.	
			Min. of Obs.	Reading Reduced.	Min. of Obs.	Reading Cor-rected.	Min. of Obs.	Reading Cor-rected.				Min. of Obs.	Reading Cor-rected.	Min. of Obs.	Reading Reduced.	Min. of Obs.	Reading Cor-rected.
July	2	6	m. 6	132-13	m. 7	576-8	m. 8	Mic. Div. 983	July	2	7	m. 51	122-47	m. 52	572-4	m. 53	Mic. Div. 883
			9	133-53	10	588-0	11	993				54	122-73	55	575-7	56	865
			14	134-00	15	586-6	17	1011	July	2	8	57	125-55	58	573-5	59	863
												0	126-42	1	572-6	2	862
			18	130-32	19	588-0	20	1012				6	130-12	8	560-7	10	874
												12	128-43	14	547-9	16	869
			24	129-17	25	582-6	26	996				18	129-30	20	545-6	22	866
												24	129-37	26	541-9	28	858
			30	130-72	31	604-7	32	1047				30	129-85	32	538-4	34	863
												42	127-97	43	584-2	44	1002
			36	128-30	37	594-4	38	1031				42	124-82	44	534-2	46	844
												27	570-2	29	1002	48	125-22
			42	127-97	43	584-2	44	1002				54	128-90	56	504-9	58	751
												45	586-6	47	987	0	125-82
			48	123-20	49	593-6	50	983				3	125-08	4	473-0	5	689
												51	117-10	52	602-3	53	959
			54	118-43	55	576-9	56	945				9	120-58	10	482-6	11	684
												57	115-48	58	571-6	59	945
July	2	7	0	108-05	1	592-4	2	925				15	116-83	16	483-4	17	653
			3	110-38	4	601-7	5	916				18	117-70	19	492-2	20	665
			6	114-35	7	602-7	8	922				21	116-70	22	501-1	23	671
												9	115-55	10	597-4	11	927
			12	113-80	13	588-6	14	932				27	114-22	28	476-0	29	637
												15	112-00	16	586-5	17	930
			18	109-12	19	604-2	20	923				33	114-35	34	466-3	35	581
												21	111-05	22	613-7	23	912
			24	115-62	25	604-4	26	906				39	113-20	40	466-0	41	558
												27	119-18	28	592-8	29	908
			30	120-72	31	594-8	32	908				45	108-16	46	447-1	47	510
												33	122-27	34	585-1	35	904
			36	121-18	37	584-1	38	901				51	119-4	52	419-4	53	458
												39	122-93	40	579-5	41	896
			42	122-20	43	569-2	44	890				57	398-8	58	398-8	59	406
												45	123-07	46	567-0	47	885
			48	125-55	49	561-3	50	889				4	104-90	4	392-9	5	345
												54	118-43	55	576-9	56	945
			57	115-48	58	571-6	59	945				8	108-43	10	110-92	11	304
												0	108-05	1	592-4	2	925
			6	114-35	7	602-7	8	922				12	117-03	12	Out of field.	14	236
												9	115-55	10	597-4	11	927
			9	115-55	10	597-4	11	927				36	139-38	38	141-05	39	214
												12	113-80	13	588-6	14	932
			12	113-80	13	588-6	14	932				44	130-18	44	323-3	45	299
												15	112-00	16	586-5	17	930
			15	112-00	16	586-5	17	930				46	126-48	47	358-4		
												18	109-12	19	604-2	20	923

Bifilar Thermometer. July 2^d 7^h, 61°-3; 9^h, 60°-6.
 Balance Thermometer. July 2^d 7^h, 61°-2; 9^h, 60°-7.
 Arcs of Vibration. Declination Magnet. July 2^d 10^h 32^m, 15'; 10^h 34^m, 7'; 10^h 36^m, 19'; 10^h 38^m, 17'; 10^h 40^m, 10'; 10^h 42^m, 26'.
 July 2^d 10^h 10^m. Bifilar Scale going out of field, reading estimated.
 July 2^d 10^h 16^m. Torsion circle of Bifilar turned from 109° 10' to 111° 35'. Various attempts were made to bring the scale into the field of the reading telescope, while the mirror for illuminating the collimator had been thrown out of position; this was not discovered till about 38^m. The Balance crosses had also gone out of sight till the wooden front of the box was removed. In the adjustment of these two instruments the Declination readings were lost for some time. After 13^h the torsion circle was turned to its original position 109° 10'.
 The observations of the Bifilar Magnetometer from 10^h 38^m till 13^h are reduced to the torsion circle reading 109° 10'. See Introduction.
 See note, page 51, on the observations in brackets.

Göttingen Mean Time.		DECLINATION.		BIFILAR.		BALANCE.		Göttingen Mean Time.		DECLINATION.		BIFILAR.		BALANCE.						
		Min. of Obs.	Reading Reduced.	Min. of Obs.	Reading Cor-rected.	Min. of Obs.	Reading Cor-rected.			Min. of Obs.	Reading Reduced.	Min. of Obs.	Reading Cor-rected.	Min. of Obs.	Reading Cor-rected.					
July	d. h.	m.	'	m.	Sc. Div.	m.	Mic. Div.	July	d. h.	m.	'	m.	Sc. Div.	m.	Mic. Div.					
	2	10	48	123-27	50	374-4	51		354	2	12	30	110-85	32	517-2	33	479			
				52	118-97	53	424-5					34	117-57	35	506-5					
				54	116-77			54		36	120-32			36	482					
				56	115-88	56	419-4	57		38	119-38	38	494-2	39	509					
				58	116-70	59	423-9			40	117-57	41	500-0							
July	2	11	0	116-77			0	287	July	2	12	42	119-03			42	500			
				2	119-12	2	423-4	3	267					44	121-12	44	500-9	45	489	
				4	123-33	5	422-6							46	124-48	47	478-8			
				6	128-17			6	244					48	121-38			48	520	
				8	130-05	8	413-5	9	265					50	114-55	50	487-1	51	529	
				10	129-85	11	417-2							52	114-00	53	491-4			
				12	128-23			12	274					54	110-78			54	516	
				14	128-77	14	432-4	15	294					56	109-65	56	495-8	57	497	
				16	127-57	17	458-8							58	110-78	59	503-4			
				18	127-50			18	307	July	2	13	0	109-85			0	488		
				20	129-23	20	463-6	21	313						2	109-92				
				22	129-23	23	458-2			July	3	19					58	523		
				24	130-72			24	321						1	132-20	2	443-6		
				26	132-53	26	405-8	27	303	July	3	20	6	136-82	7	443-4	8	551		
				28	128-70	29	390-7													
				30	126-22			30	292					9	140-98	10	439-6	11	564	
				32	121-58	32	390-9	33	315					12	133-27	13	435-9	14	560	
				34	118-70	35	406-8													
				36	122-60			36	301					15	136-42	16	435-0	17	558	
				38	131-32	38	410-2	39	220											
				40	138-43	41	392-1							18	136-15	19	430-3	20	560	
				42	139-58			42	156											
				44	142-92	44	355-2	45	109					21	136-95	22	422-9	23	538	
				46	147-83	47	288-7							24	139-58	25	422-9	26	533	
				48	150-28			48	74											
				50	139-98	50	293-3	51	177					27	135-62	28	430-6	29	524	
				52	113-33	53	396-5													
				54	108-23			54	119					30	137-15	31	417-8	32	521	
				56	118-43	56	442-2	57	128											
				58	116-77	59	486-3							33	138-03	34	420-3	35	532	
July	2	12	0	115-82			0	165	July	3	20	36	141-60	37	430-8	38	548			
				2	126-82	2	513-6	3	194					39	139-32	40	422-7	41	565	
				4	134-75	5	502-5													
				6	140-12			6	264					42	136-48	43	414-3	44	561	
				8	133-13	8	481-0	9	369											
				10	124-48	11	486-2							45	138-10	46	424-5	47	551	
				12	118-83			12	386											
				14	120-52	14	482-2	15	392					48	136-75	49	424-1	50	538	
				16	116-77	17	515-7													
				18	113-80			18	426					51	134-60	52	416-0	53	541	
				20	108-78	20	530-3	21	472											
				22	106-63	23	553-9							54	136-48	55	417-2	56	552	
				24	110-52			24	463											
				26	115-62	26	537-9	27	488											
				28	112-53	29	527-1													

Bifilar Thermometer. July 2^d 11^h, 60°-1; 12^h, 59°-7; 13^h, 59°-2; 3^d 20^h, 56°-4.

Balance Thermometer. July 2^d 11^h, 63°-3; 12^h, 62°-2; 13^h, 61°-1; 3^d 20^h, 56°-4.

Arcs of Vibration. Declination Magnet. July 2^d 10^h 48^m, 7'; 10^h 50^m, 8'; 11^h 52^m, 8'; 3^d 20^h 12^m, 8'; 20^h 48^m, 9'; 20^h 54^m, 13'. Bifilar Magnet. July 2^d 11^h 23^m, 10^{div}; 11^h 41^m (21^{div} down); 11^h 43^m (42^{div} up); 11^h 59^m, 10^{div}; 12^h 11^m, 12^{div}; 3^d 20^h 25^m, 17^{div}; 20^h 28^m, 22^{div}; 20^h 31^m, 10^{div}; 20^h 34^m, 15^{div}; 20^h 43^m, 24^{div}; 20^h 52^m, 16^{div}; 20^h 55^m, 35^{div} (noted).

July 2^d 12^h 23^m. Reading of Bifilar estimated, Scale going out of field.

July 3^d 20^h 0^m. The following are the readings of the Declination 18^s before and 18^s after the minute, the reading at the minute having been lost, 19^h 59^m 42^s, 116°-8; 20^h 0^m 18^s, 127°-6.

See note, page 51, on the observations in brackets.

Göttingen Mean Time.		DECLINATION.		BIFILAR.		BALANCE.		Göttingen Mean Time.		DECLINATION.		BIFILAR.		BALANCE.	
		Min. of Obs.	Reading Reduced.	Min. of Obs.	Reading Cor-rected.	Min. of Obs.	Reading Cor-rected.			Min. of Obs.	Reading Reduced.	Min. of Obs.	Reading Cor-rected.	Min. of Obs.	Reading Cor-rected.
July	d. h.	m.	'	m.	Sc. Div.	m.	Mic. Div.	July	d. h.	m.	'	m.	Sc. Div.	m.	Mic. Div.
July	3 20	57	133-67	58	442-5	59	538	July	3 22	36	140-38	37	496-5	38	720
					422-4					39	139-32	40	503-8	41	716
July	3 21	0	134-20	1	397-4	2	532			42	138-30	43	511-7	44	716
					387-2					45	137-43	46	505-0	47	716
					469-2					48	136-02	49	497-8	50	724
		3	148-19	4	356-0	5	603				(136-35)		(501-9)		
		6	144-09	7	397-6	8	582			51	135-42	52	502-1	53	722
					(401-8)						(137-70)		(505-2)		
		9	130-45	10	397-6	11	573			54	135-28	55	502-8	56	730
					(404-5)								(499-4)		
		12	136-55	13	389-9	14	611			57	135-55	58	498-8	58	742
					(383-9)									59	757
		15	140-78	16	388-5	17	613	July	3 23	0	133-27	1	494-2		
		18	149-71	19	402-7	20	604					2	501-6	2	757
					(404-5)					3	131-05	4	494-7	5	771
		21	155-70	22	423-7	23	592			6	130-85	7	490-3	8	767
					(427-8)								(489-2)		
		24	146-84	25	446-8	26	590			9	131-45	10	484-2	11	779
		27	150-58	28	457-0	29	592						(482-4)		
			(149-63)		(460-2)					12	133-87	13	477-7	14	785
		30	150-58	31	452-6	32	617			15	135-95	16	482-1	17	793
		33	146-77	34	483-7	35	638			18	136-62	19	503-5	20	777
					(485-3)					21	135-88	22	473-0	23	806
		36	142-47	37	494-4	38	644			24	137-97	25	460-2	26	806
					(481-6)								(468-2)		
		39	143-27	40	526-8	41	634			27	135-22	28	467-6	29	809
		42	139-32	43	505-0	44	642			30	137-83	31	480-6	32	799
					(503-8)					33	137-23	34	502-0	35	791
		45	140-38	46	514-1	47	661						(505-0)		
		48	140-52	49	521-4	50	669			36	136-02	37	508-0	38	789
		51	138-17	52	503-0	53	685			39	136-35	40	506-2	41	779
			(130-58)		(496-9)								(503-4)		
		54	129-58	55	492-0	56	679			42	137-97	43	501-8	44	767
		57	134-40	58	502-3	59	684			45	138-23	46	497-3	47	780
					(503-5)					48	136-62	49	487-3	50	789
July	3 22	0	135-42	1	503-4	2	683			51	139-78	52	491-5	53	791
					(505-5)					54	138-58	55	497-0	56	803
		3	136-42	4	506-8	5	684			57	137-15	58	492-9	59	818
					(510-2)								(495-2)		
		6	139-85	7	505-2	8	682	July	4 0	0	137-23	1	499-0	2	822
					(506-4)					3	135-28	4	499-5	5	822
		9	140-78	10	511-9	11	689						(501-5)		
					(510-4)					6	137-23	7	500-2	8	821
		12	141-67	13	508-0	14	693						(502-1)		
					(512-2)					9	136-42	10	504-7	11	817
		15	142-00	16	498-5	17	692			12	135-48	13	508-3	14	815
					(497-0)					15	136-42	16	508-9	17	822
		18	138-52	19	486-3	20	702			18	134-68	19	503-6	20	828
		21	140-65	22	502-5	23	710			21	135-48	22	502-4	23	834
		24	142-54	25	502-9	26	710			24	135-68	26	500-3	28	836
					(504-5)					30	135-68	32	501-3	34	829
		27	142-87	28	501-6	29	716			36	134-68	38	514-2	40	837
					(497-9)					42	132-93	43	520-1	44	847
		30	141-87	31	496-5	32	721			45	132-27	46	517-8	47	854
		33	142-47	34	489-2	35	716			48	132-67	49	516-1	50	858
					(488-2)					52	133-40	54	516-8	56	863

July 3^d 21^h 1^m. The four observations in brackets are the readings at 0^m 35^s, 1^m 0^s, 1^m 25^s, and 1^m 50^s. Between 1^m 25^s and 1^m 50^s the magnet went up 110^{div}. 21^h 4^m. Reading of Bifilar estimated, Scale going out of field.

Bifilar Thermometer. July 3^d 21^h 56^o 4; 22^h 57^o 0; 23^h 58^o 2; 4^d 0^h 58^o 8.

Balance Thermometer. July 3^d 21^h 56^o 5; 22^h 57^o 0; 23^h 57^o 9; 4^d 0^h 58^o 4.

Arcs of Vibration. Declination Magnet. July 3^d 20^h 57^m 7; 21^h 3^m 67' (noted); 21^h 6^m 44'; 21^h 9^m 22'; 21^h 12^m 15'; 21^h 39^m 9'; 21^h 42^m 7'.

Bifilar Magnet. July 3^d 20^h 58^m, 15^{div}; 21^h 7^m, 12^{div}; 21^h 10^m, 30^{div}; 21^h 13^m, 20^{div}; 21^h 19^m, 10^{div}; 21^h 22^m, 10^{div}; 21^h 31^m, 40^{div} (noted); 21^h 37^m, 40^{div} (noted); 21^h 55^m, 11^{div}; 22^h 1^m, 11^{div}; 22^h 19^m, 14^{div}; 22^h 37^m, 14^{div}; 22^h 52^m, 13^{div}; 23^h 22^m, 12^{div}; 23^h 25^m, 52^{div}; 23^h 28^m, 16^{div}; 23^h 43^m, 10^{div}; 23^h 58^m, 20^{div} (noted).

See note, page 51, on the observations in brackets.

Göttingen Mean Time.			DECLINATION.		BIFILAR.		BALANCE.		Göttingen Mean Time.			DECLINATION.		BIFILAR.		BALANCE.	
			Min. of Obs.	Reading Reduced.	Min. of Obs.	Reading Cor- rected.	Min. of Obs.	Reading Cor- rected.				Min. of Obs.	Reading Cor- rected.	Min. of Obs.	Reading Reduced.	Min. of Obs.	Reading Cor- rected.
July	d.	h.	m.	'	m.	Sec. Div.	m.	Mic. Div.	July	d.	h.	m.	'	m.	Sec. Div.	m.	Mic. Div.
July	4	0	57	131.85			58	865	July	4	3	48	131.98	50	577.8	52	1017
			0	132.33	2	516.0	4	874				54	131.05	56	576.3	58	1032
			6	131.25	7	529.4	8	868	July	4	4	0	125.75	2 ₂	602.5	4	1012
					9	537.7						6	128.50	8	616.0	10	1000
					10	538.2	11	868				12	133.40	14	612.6	16	1009
			12	131.12	13	529.2	14	876				18	128.30	20	618.7	22	980
			15	134.07	16	531.1	17	881				24	130.92	26	611.1	28	989
			18	130.25	19	535.5	20	887				30	132.87	32	619.5	34	990
			21	127.70	22	541.4	23	909				36	135.22	38	613.5	40	992
				(134.53)		(542.6)						42	137.70	44	609.0	46	1007
			24	135.22	25	547.1	26	915				48	131.25	50	629.2	52	1051
						(545.5)			July	4	5	54	126.75	56	627.4	58	959
			27	132.40	28	540.2	29	913				0	129.43	2	572.7	4	939
						(537.7)						6	136.08	8	533.7	10	944
			30	135.28	31	519.7	32	929				12	132.73	14	542.6	16	931
			33	136.68	34	520.5	35	934				18	132.47	19	542.9	20	922
			36	135.95	38	526.8	40	948				21	134.20	22	548.4	23	917
			42	123.40	44	529.5	46	984				24	135.08	25	550.2	26	915
			48	128.30	50	572.4	52	1044				27	137.08	28	552.8	29	914
					52	604.4	54	1057				30	137.23	31	555.1	32	917
					53	613.2						33	135.62	34	557.6	35	921
			54	127.50								36	132.47	37	560.5	38	923
					56	616.4						39	128.57	40	568.0	41	920
			58	123.87	58	630.7	59	1063				42	127.17	43	569.0	44	917
						(635.2)						45	127.50	46	566.2	47	912
July	4	2	0	123.87	0	636.9	1	1064				48	127.50	49	565.9	50	908
			2	122.93	2	625.6	3	1038				51	128.50	52	571.0	53	911
			4	123.47	4	632.4	5	1035				54	129.72	55	562.7	56	914
			6	124.00	6	611.3	7	1037	July	4	6	57	127.23	58	557.7	59	914
			8	122.20	8	604.1	9	1061				0	128.03	1	555.5	2	914
			10	123.27	10	630.1	11	1063				3	127.30	4	552.2	5	915
			12	123.60	12	631.6	13	1064				6	125.42	8	549.3	10	915
			14	122.93	14	623.0	15	1079				12	122.27	14	551.3	16	905
			16	123.80								18	122.73	20	558.7	22	893
			18	123.20	18	614.4	19	1076				24	127.43	26	562.2	28	884
						(585.1)						30	130.38	32	550.4	34	877
			20	119.58			21	1082				36	131.52	38	544.5	40	870
			22	119.18	22	567.2	23	1079				42	132.73	44	530.7	46	869
			24	123.73	24	571.9	25	1075				48	131.45	50	534.6	52	865
					26	570.6	27	1065	July	4	7	54	131.65	56	533.8	58	866
			28	126.90	28	568.0	29	1062				0	131.25	2	525.9	4	870
			30	123.87	30	576.1	31	1063				6	130.52	8	530.3	10	867
			32	121.05	32	597.6	33	1054				12	130.32	14	531.0	16	867
			34	130.25	34	603.6	35	1043				18	130.92	20	531.7	22	870
			36	128.83	38	614.5	40	1027				24	131.52	26	528.1	28	865
			42	130.92	44	570.7	46	1022				30	131.65	32	529.9	34	864
			48	126.42	50	587.3	52	1003	July	4	9	36	131.65	38	530.8		
			54	126.82	56	581.5	58	995				30	136.15	32	530.6	28	823
July	4	3	0	128.97	2	580.3	4	992	July	4	10	0	133.13	2	524.8	58	814
			6	128.57	8	588.2	10	968									
			12	132.05	14	571.7	16	974									
			18	131.12	20	577.4	22	972	July	9	4					58	862
			24	131.85	26	570.6	28	986	July	9	5	0	134.33	2	565.6	28	897
			30	128.03	32	602.5	34	1001				30	132.27	32	543.7	34	892
			36	134.20	38	590.8	40	1001				36	132.93	38	548.2		
			42	133.53	44	585.4	46	1015									

July 4^d 2^h 18^m. The reading in brackets made at 18^m 50^s. 17^m 35^s till 19^m 15^s, the Bifilar magnet went down 48^{dir}.
 Bifilar Thermometer. July 4^d 1^h, 59°:6; 2^h, 60°:5; 3^h, 61°:2; 5^h, 62°:4; 6^h, 62°:8; 7^h, 62°:9; 9^d 5^h, 65°:1.
 Balance Thermometer. July 4^d 1^h, 59°:2; 2^h, 59°:9; 3^h, 60°:5; 5^h, 61°:7; 6^h, 62°:2; 7^h, 62°:4; 9^d 5^h, 63°:7.
 Arcs of Vibration. Bifilar Magnet. July 4^d 1^h 58^m, 10^{dir}; 2^h 7^m, 12^{dir}; 2^h 8^m, 40^{dir}; 3^h 31^m, 18^{dir}.
 See note, page 51, on the observations in brackets.

Göttingen Mean Time.	DECLINATION.		BIFILAR.		BALANCE.		Göttingen Mean Time.	DECLINATION.		BIFILAR.		BALANCE.	
	Min. of Obs.	Reading Reduced.	Min. of Obs.	Reading Cor- rected.	Min. of Obs.	Reading Cor- rected.		Min. of Obs.	Reading Reduced.	Min. of Obs.	Reading Cor- rected.	Min. of Obs.	Reading Cor- rected.
July 22 19	d. h.						Aug. 19 5						
July 22 20	m.	'	m.	Sec. Div.	m.	Mic. Div.	Aug. 19 5	m.	'	m.	Sec. Div.	m.	Mic. Div.
	0	131.75	2	521.0	58	779		18	124.55	19	557.3	21	1080
	6	131.98	8	520.7	10	778				20	558.0	22	1074
	12	130.85	14	523.0	16	779		24	123.73	26	565.9	27	1044
	18	130.18						30	126.62	31	576.8	28	1037
	28	129.17								32	578.2	33	1011
July 29 5	0	134.07	2	547.7				35	129.37			34	1007
			4	561.4				36	130.05	38	578.6	39	986
			5	564.1				42	132.47	44	575.9	40	984
			6	563.4				48	134.88	50	572.9	46	975
July 31 19					58	714						52	973
July 31 20	0	124.27	2	519.1			Aug. 19 6	0	134.53	2	564.7	58	980
			3	524.2						8	575.0		
			4	527.3				18	129.43	20	555.8	22	904
	10	122.00	12	520.3	14	775		24	127.43	26	543.6	28	1000
	18	122.13	20	522.5				30	124.82				
Aug. 4 22					58	767		48	125.35	44	559.2	46	964
Aug. 4 23	0	138.92	2	517.3			Aug. 19 7	0	127.50	2	563.1	52	944
	6	138.17	8	520.2	10	754					58	932	
	12	134.33	14	523.0	16	753		24	126.02	26	550.0	22	925
Aug. 5 19					58	715		48	125.35			58	864
Aug. 5 20	0	131.78	2	506.9			Aug. 19 8	0	127.50	2	537.6		
	12	127.03	14	512.9	16	726							
					28	732							
	30	125.08	32	520.4	58	751	Aug. 24 4					58	846
Aug. 5 21	0	124.55	2	521.7			Aug. 24 5	0	131.80	2	538.5	16	873
Aug. 5 22					58	792		12	125.62	14	547.8	22	874
Aug. 5 23	0	125.82	2	494.9				18	124.48	20	543.3	58	860
	30	129.78	32	507.7	34	803	Aug. 24 6	0	127.17	2	548.3		
Aug. 6 0	30	131.65	32	523.6	34	799							
Aug. 6 1					58	794	Sept. 2 1					58	767
Aug. 6 2	0	134.82	2	529.2			Sept. 2 2	0	132.40	2	538.8	22	886
Aug. 6 4					58	881	Sept. 2 3					28	893
Aug. 6 5	0	124.07	2	531.6				24	131.92	26	527.2	34	905
								30	130.32	32	529.2	40	902
	24	122.40	26	573.3	22	858		36	128.37	38	536.7	46	896
	30	121.65	32	573.4	28	854		42	127.23	44	538.7	34	896
	42	124.35	44	557.1			Sept. 2 4	36	130.32	32	544.2	58	849
			45	553.5	46	868							
Aug. 6 6					58	802	Sept. 2 5	0	130.95	2	542.5		
Aug. 6 7	0	29.43	2	550.5			Sept. 2 6					2	839
							Sept. 2 8	6	105.68				
Aug. 16 19					58	758		12	102.33			16	831
Aug. 16 20	0	120.15	2	532.2				18	96.49	20	534.9	22	820
	36	126.75	32	504.3	34	700		24	94.28	26	548.2	28	799
								30	100.79	32	553.3	34	790
Aug. 19 4					58	1124		36	108.72	38	540.9	40	787
Aug. 19 5	0	125.05	2	595.2				42	110.32	44	544.1	46	781
	6	127.03	9	585.9	10	1117		48	114.00	50	542.2	52	776
	12	126.08	13	567.2				54	115.45	56	544.2	58	771
			14	564.6	15	1104	Sept. 2 9	0	117.70	2	536.1		
					16	1100							

Bifilar Thermometer. July 22^d 20^h, 52°·9; 29^d 5^h, 61°·5; 31^d 20^h, 60°·9; Aug. 4^d 23^h, 64°·7; 5^d 20^h, 56°·9; 5^d 21^h, 57°·2; 5^d 23^h, 58°·8; 6^d 0^h, 60°·6; 6^d 2^h, 62°·6; 6^d 5^h, 65°·6; 6^d 7^h, 67°·0; 16^d 20^h, 61°·3; 19^d 5^h, 72°·0; 19^d 6^h, 72°·0; 19^d 7^h, 71°·0; 19^d 8^h, 69°·9; 24^d 5^h, 63°·5; 24^d 6^h, 63°·4; Sept. 2^d 2^h, 65°·7; 2^d 5^h, 66°·2; 2^d 9^h, 65°·6.
 Balance Thermometer. July 22^d 20^h, 53°·1; 31^d 20^h, 61°·3; Aug. 4^d 23^h, 63°·8; 5^d 20^h, 57°·3; 5^d 21^h, 57°·5; 5^d 23^h, 58°·6; 6^d 0^h, 60°·0; 6^d 2^h, 61°·6; 6^d 5^h, 64°·1; 6^d 7^h, 64°·1; 16^d 20^h, 61°·2; 19^d 5^h, 71°·6; 19^d 6^h, 71°·6; 19^d 7^h, 70°·8; 19^d 8^h, 69°·8; 24^d 5^h, 63°·5; 24^d 6^h, 63°·5; Sept. 2^d 2^h, 65°·2; 2^d 5^h, 65°·7; 2^d 9^h, 65°·4.

Göttingen Mean Time.		DECLINATION.		BIFILAR.		BALANCE.		Göttingen Mean Time.		DECLINATION.		BIFILAR.		BALANCE.	
		Min. of Obs.	Reading Reduced.	Min. of Obs.	Reading Cor-rected.	Min. of Obs.	Reading Cor-rected.			Min. of Obs.	Reading Reduced.	Min. of Obs.	Reading Cor-rected.	Min. of Obs.	Reading Cor-rected.
Sept. 5	4					58	803	Oct. 17	6	36	121-73	38	542-4	40	780
Sept. 5	5	0	129-25	2	553-4							44	548-1	46	773
Sept. 5	6	48	115-88	50	553-9	52	865	Oct. 17	19					58	758
		54	115-35	56	558-9	58	862	Oct. 17	20	0	126-46	2	529-3		
Sept. 5	7	12	121-65	14	550-4	16	848			40	124-48	36	531-8	35	760
Sept. 20	4					58	791	Oct. 17	22					58	762
Sept. 20	5	0	135-52	2	545-5			Oct. 17	23	0	126-45	2	523-7		
Sept. 20	7	36	109-45	38	584-3	40	758	Oct. 18	0	2	129-43	1	537-9	0	773
		42	114-48	43	579-8			Oct. 18	1	4	131-38	2	550-1	1	758
		48	114-07	50	568-3	52	759							58	747
Sept. 20	19					28	774	Oct. 18	2	0	130-92	2	548-7		
		30	134-88	32	509-9			Oct. 18	3	4	132-87	2	552-8	1	748
						58	757	Oct. 18	4					58	767
Sept. 20	20	0	135-42	2	525-5			Oct. 18	5	0	126-30	2	542-2		
Sept. 20	21	0	128-77	2	529-6	58	760	Nov. 3	4					58	758
Sept. 20	22	0	131-38	2	529-8	58	779	Nov. 3	5	0	133-53	2	544-0	56	882
Sept. 20	23	0	136-28	2	521-9	58	777	Nov. 3	7					58	873
Sept. 21	0	0	136-48	2	545-0			Nov. 3	8	0	117-57	2	527-2		
Sept. 21	1	0	135-42	2	542-2	58	766			12	121-05	10	532-2	14	855
Sept. 21	2	0	137-30	2	539-0			Nov. 5	1					58	756
Sept. 21	3	0	134-95	2	542-6	58	776	Nov. 5	2	0	131-27	2	542-7		
Sept. 21	4	0	132-73	2	544-3			Nov. 5	3	30	130-07			4	758
Sept. 21	5	0	130-72	2	544-3	58	789	Nov. 5	4	0	128-87	2	544-5	34	753
Sept. 21	6	0	129-92	2	546-4					30	128-17	32	545-0	58	761
Sept. 21	7	0	128-70	2	545-8	58	791	Nov. 5	5	0	127-65	2	544-2		
Sept. 21	8	0	125-28	2	557-6					42	127-70	44	545-2	46	755
						58	808	Nov. 5	6	0	126-87	2	550-0	4	743
Oct. 17	4					58	764			30	127-18	32	547-9	34	733
Oct. 17	5	0	116-43	2	547-0			Nov. 9	19					58	704
		12	108-03	13	534-1	14	808	Nov. 9	20	0	126-02	2	543-8		
		15	107-15	16	536-4	17	811	Nov. 9	21	3	123-80	0	536-5	0	747
		18	116-01	20	544-7	22	808	Nov. 9	22					58	745
		24	105-08	26	556-7	28	809	Nov. 9	23	0	134-95	2	521-1		
		30	107-70	32	551-1	34	811							32	758
		36	109-58	38	544-1	40	814	Nov. 10	0						
		48	110-98	50	540-1	52	813	Nov. 10	1	30	140-32	21	526-3	20	774
						58	812							58	776
Oct. 17	6	0	115-22	2	528-9			Nov. 10	2	0	138-37	2	548-4		
		12	121-05	14	533-6	16	807	Nov. 10	3	3	133-07	2	539-2	0	786
		30	126-35	32	534-3	34	796			49	125-42	48	512-6	46	851
								Nov. 10	4	25	117-83	26	536-5	28	828
										30	119-65				
								Nov. 10	4	48	126-90	50	538-0	52	809
														58	801
								Nov. 10	5	0	126-97	2	544-0		
														58	805
								Nov. 10	6	0	129-43	2	533-5		
														58	718

Bifilar Thermometer. Sept. 5^d 5^h, 59°8'; 5^d 7^h, 60°5'; 20^d 5^h, 62°4'; 20^d 7^h, 63°0'; 20^d 20^h, 50°4'; 20^d 23^h, 52°3'; 21^d 2^h, 58°6'; 21^d 5^h, 61°4'; 21^d 7^h, 60°0'; 21^d 10^h, 57°8'; Oct. 17^d 5^h, 51°0'; 17^d 6^h, 50°8'; 17^d 20^h, 46°5'; 17^d 23^h, 46°0'; 18^d 0^h, 49°3'; 18^d 1^h, 55°1'; 18^d 2^h, 57°4'; 18^d 3^h, 59°2'; 18^d 5^h, 57°5'; Nov. 3^d 5^h, 57°7'; 3^d 8^h, 56°2'; 5^d 2^h, 54°5'; 5^d 5^h, 55°3'; 5^d 6^h 30^m, 55°9'; 9^d 20^h, 48°4'; 9^d 21^h, 48°4'; 9^d 23^h, 48°5'; 10^d 0^h, 51°2'; 10^d 1^h 30^m, 54°1'; 10^d 2^h, 54°4'; 10^d 3^h, 54°7'; 10^d 5^h, 55°5'; 10^d 6^h, 54°5'.
 Balance Thermometer. Sept. 5^d 5^h, 58°9'; 5^d 7^h, 59°0'; 20^d 5^h, 60°4'; 20^d 7^h, 60°0'; 20^d 20^h, 50°8'; 20^d 23^h, 52°6'; 21^d 2^h, 58°1'; 21^d 5^h, 60°4'; 21^d 7^h, 60°8'; 21^d 10^h, 57°9'; Oct. 17^d 5^h, 50°6'; 17^d 6^h, 50°5'; 17^d 20^h, 46°9'; 17^d 23^h, 46°4'; 18^d 0^h, 49°6'; 18^d 1^h, 56°2'; 18^d 2^h, 57°9'; 18^d 3^h, 59°6'; 18^d 5^h, 57°6'; Nov. 3^d 5^h, 57°8'; 3^d 8^h, 57°6'; 5^d 2^h, 55°8'; 5^d 5^h, 56°8'; 5^d 6^h 30^m, 61°0'; 9^d 20^h, 50°1'; 9^d 21^h, 50°8'; 9^d 23^h, 50°3'; 10^d 0^h, 53°4'; 10^d 1^h 30^m, 55°4'; 10^d 2^h, 55°4'; 10^d 3^h, 55°7'; 10^d 3^h 50^m, 57°6'; 10^d 5^h, 56°7'; 10^d 6^h, 56°7'.

Göttingen Mean Time.		DECLINATION.		BIFILAR.		BALANCE.		Göttingen Mean Time.		DECLINATION.		BIFILAR.		BALANCE.	
		Min. of Obs.	Reading Reduced.	Min. of Obs.	Reading Cor-rected.	Min. of Obs.	Reading Cor-rected.			Min. of Obs.	Reading Reduced.	Min. of Obs.	Reading Cor-rected.	Min. of Obs.	Reading Cor-rected.
d. h.	m.			m.	Sec. Div.	m.	Mic. Div.	d. h.	m.		m.	Sec. Div.	m.	Mic. Div.	
Nov. 10	20	0	132-64	2	521-9	34	719	Dec. 9	4	0	125-45	2	539-4	58	755
		30	131-92	32	535-7	58	755	Dec. 9	5	18	125-75	20	531-4	22	765
Nov. 10	22									24	125-02	26	538-0	28	768
Nov. 10	23	0	126-70	2	530-3	33	752			30	125-02	32	538-0	34	783
Nov. 11	1			32	532-5	58	750			36	122-53	38	539-6	40	800
Nov. 11	2	0	130-50	2	539-9	58	754			42	118-23	44	550-8	46	813
Nov. 11	3	0	128-37	2	540-7	40	766	Dec. 9	6	48	112-53	50	553-0	52	796
				41	541-2					54	109-58	56	544-3	58	775
Nov. 19	3	30	127-57	32	545-0	34	719			0	112-13	2	542-6	4	768
Nov. 19	4	0	127-35	2	546-6	4	715			6	116-08	8	544-1	10	765
		30	126-82	32	546-0	34	719			12	120-65	14	541-3	16	769
Nov. 19	6	0	127-00	2	550-3	4	713			18	125-88	20	536-5	22	789
		42	125-85	44	551-8	46	707			24	120-45	26	544-9	28	781
Nov. 19	7	0	126-02	2	550-9	4	704			30	127-37	32	535-7	34	785
		24	125-88	26	549-7	28	704			36	129-52	38	529-7	40	802
		54	125-33	56	550-6	58	704			42	128-43	44	533-2	46	819
Nov. 21	19					58	647	Dec. 9	7	48	125-15	50	541-2	52	841
Nov. 21	20	0	127-94	2	500-2	16	669			54	122-60	56	537-6	58	868
		18	137-50	14	502-5	34	693			0	119-58	2	533-6	4	890
		30	139-58	32	507-3	46	694			6	110-12	8	530-9	10	863
Nov. 21	21	4	137-43	2	521-2	0	721			12	112-13	14	534-7	16	841
		18	135-33	16	527-8	20	740			18	113-47	20	525-8	22	837
Nov. 22	1	0	130-72	2	528-7	58	807			24	113-27	26	533-5	28	820
Nov. 22	2	54	126-08	56	543-9	58	871			30	116-08	32	525-1	34	818
Nov. 22	3	0	129-72	2	545-1	4	872			36	115-28	38	527-2	40	831
		6	130-32	8	545-6	40	862			42	112-13	44	542-2	46	831
		42	129-98	44	541-2	58	829			48	121-05	50	527-6	52	843
Nov. 22	4	0	127-63	2	539-6	58	829	Dec. 9	8	54	118-10	56	520-6	58	847
Nov. 22	5									0	113-47	2	530-8	4	834
Dec. 5	19					58	711			6	121-05	8	527-5	10	835
Dec. 5	20	0	129-55	2	534-5	22	697			24	136-22	26	510-4	28	876
		24	128-97	26	554-8	34	688			30	127-30	32	530-4	34	896
		30	130-12	32	553-2	40	685			36	113-60	38	527-4	40	846
		36	129-72	38	558-1	46	681			42	118-10	44	536-4	46	819
Dec. 5	20	42	129-03	44	557-0	52	680	Dec. 17	1	0	126-55	2	550-7	58	711
		48	128-37	50	556-5	58	686	Dec. 17	2	30	125-52	32	549-1	34	712
		54	128-37	56	553-2			Dec. 17	3	0	125-43	2	548-7	4	709
										18	126-32	20	549-0	22	709
										42	124-92	44	550-1	46	707
								Dec. 17	5	0	125-35	2	549-4	4	704
										24	125-05	26	549-2	28	695

Bifilar Thermometer. Nov. 10^d 20^h, 49°-4; 10^d 23^h, 50°-2; 11^d 1^h 30^m, 57°-8; 11^d 2^h, 57°-8; 11^d 3^h, 58°-2; 19^d 2^h, 51°-9; 19^d 5^h, 57°-8; 19^d 8^h, 58°-6; 21^d 20^h, 43°-4; 21^d 21^h, 44°-5; 22^d 2^h, 50°-8; 22^d 3^h, 52°-1; 22^d 3^h 45^m, 53°-2; 22^d 5^h, 51°-9; Dec. 5^d 20^h, 52°-8; 5^d 21^h, 52°-9; 9^d 5^h, 56°-3; 9^d 6^h, 56°-4; 9^d 7^h, 56°-8; 9^d 8^h, 56°-9; 17^d 2^h, 56°-5; 17^d 5^h, 57°-8.

Balance Thermometer. Nov. 10^d 20^h, 50°-6; 10^d 23^h, 51°-3; 11^d 1^h 30^m, 59°-6; 11^d 2^h, 59°-2; 11^d 3^h, 59°-5; 19^d 2^h, 52°-9; 19^d 5^h, 58°-5; 19^d 8^h, 60°-1; 21^d 20^h, 45°-1; 21^d 21^h, 47°-3; 22^d 2^h, 52°-3; 22^d 3^h, 53°-8; 22^d 3^h 45^m, 54°-2; 22^d 5^h, 53°-6; Dec. 5^d 20^h, 54°-1; 5^d 21^h, 54°-2; 9^d 5^h, 57°-3; 9^d 6^h, 57°-5; 9^d 7^h, 57°-8; 9^d 8^h, 58°-0; 17^d 2^h, 58°-2; 17^d 5^h, 59°-8.

OBSERVATIONS OF MAGNETIC DIP.

1841 AND 1842.

Göttingen Mean Time, Commencement of Observations.	Dura- tion of Obser- vation.	Thermo- meter.	No. of Needle.	MEAN OF READINGS.		A. North <i>Minus</i> B. North.	Observed Dip.	REMARKS.
				End A. North.	End B. North.			
d. h. m.	m.	°		° ' "	° ' "	' "	° ' "	
1841.								
Apr. 29				71 29-13	71 24-00	+ 5-13	71 26-56	{Unsatisfactory observation. Instrument out of adjustment. Observers, Professor Forbes and Mr. Russell. {Double observation; unsatisfactory. Needle continually getting into contact with limb. Observers, Mr. Main and Mr. Russell. {This and the two following observations made by Professor Forbes. {A small knife in the observer's pocket while observing B. North.
July 7 1 0		61-0	1	71 19-4	71 28-4	- 9-00	71 23-9	
July 20 6 0			2	71 15-50	71 29-37	- 13-87	71 22-45	
July 20 7 10		60-0	1	71 23-12	71 23-00	+ 0-12	71 23-06	
Sept. 6 6 5			1	71 27-12	71 21-12	+ 6-00	71 24-12	
Sept. 6 6 55			2	71 19-62	71 32-37	- 12-75	71 26-00	
Sept. 14 5 0		69-0	1	71 29-00	71 27-50	+ 1-50	71 28-25	
Sept. 14 5 45		69-0	2	71 19-62	71 35-25	- 15-63	71 27-44	
Sept. 27 20 20		55-0	1	71 29-38	71 23-00	+ 6-38	71 26-19	
Oct. 4 20 40		55-0	1	71 35-62	71 30-38	+ 5-24	71 33-00	
Oct. 8 5 15		56-5	1	71 30-75	71 18-25	+ 12-50	71 24-50	
Oct. 11 20 20		45-5	1	71 28-88	71 20-25	+ 8-63	71 24-56	
Oct. 15 5 10		48-0	1	71 38-38	71 21-38	+ 17-00	71 29-88	
Oct. 18 20 20		38-0	1	71 43-75	71 23-87	+ 19-88	71 33-81	
Oct. 22 5 15		48-0	1	71 38-25	71 16-25	+ 22-00	71 27-25	
Oct. 25 20 20		40-0	1	71 37-25	71 25-37	+ 11-88	71 31-31	
Oct. 29 5 20		52-6	1	71 28-12	71 17-75	+ 10-37	71 22-94	
Nov. 1 20 15		37-0	1	71 28-88	71 22-62	+ 6-26	71 25-75	
Nov. 5 5 10		50-0	1	71 26-38	71 22-00	+ 4-38	71 24-19	
Nov. 8 20 15		49-6	1	71 31-38	71 24-62	+ 6-76	71 28-00	
Nov. 12 5 20		44-5	1	71 29-75	71 26-37	+ 3-38	71 28-06	
Nov. 15 20 20		28-5	1	71 23-38	71 30-00	- 6-62	71 26-69	
Nov. 19 5 10		45-0	1	71 22-25	71 26-00	- 3-75	71 24-12	
Nov. 22 20 20		36-3	1	71 26-00	71 10-88	+ 15-12	71 18-44	
Nov. 26 6 45			1	71 32-25	71 17-00	+ 15-25	71 24-62	
Nov. 29 20 20		45-0	1	71 18-88	71 25-62	- 6-74	71 22-25	
Dec. 28 2 0			1	71 28-88	71 17-75	+ 11-13	71 23-31	
Dec. 28 23 0			2	71 21-00	71 33-00	- 12-00	71 27-00	
Dec. 29 0 10			2	71 16-38	71 30-62	- 14-24	71 23-50	
1842.								
Jan. 14 5 10		47-0	1	71 24-25	71 17-62	+ 6-63	71 20-94	
Jan. 17 20 20		38-0	1	71 27-00	71 11-62	+ 15-38	71 19-31	
Jan. 24 20 10		39-0	1	71 26-50	71 20-00	+ 6-50	71 23-25	
Jan. 28 5 10		51-0	1	71 23-25	71 25-50	- 2-25	71 24-38	
Jan. 31 20 15		45-0	1	71 23-88	71 22-62	+ 1-26	71 23-25	
Feb. 4 5 10		53-0	1	71 28-75	71 22-88	+ 5-87	71 25-81	
Feb. 7 20 20		45-0	1	71 31-25	71 22-50	+ 8-75	71 26-88	
Feb. 11 5 15		53-0	1	71 27-62	71 20-50	+ 7-12	71 24-06	
Feb. 14 20 25		51-0	1	71 27-12	71 23-88	+ 3-24	71 25-50	
Feb. 18 5 15		56-0	1	71 30-12	71 26-88	+ 3-24	71 28-50	
Feb. 21 20 20		40-0	1	71 24-62	71 23-78	+ 0-84	71 24-20	
Feb. 25 5 20		49-0	1	71 25-00	71 26-50	- 1-50	71 25-75	
Mar. 4 5 20		55-0	1	71 27-00	71 21-37	+ 5-63	71 24-19	
Mar. 7 20 15		49-0	1	71 26-62	71 21-25	+ 5-37	71 23-94	
Mar. 11 5 20		53-0	1	71 28-50	71 18-62	+ 9-88	71 23-56	
Mar. 14 20 30		50-0	1	71 26-50	71 23-75	+ 2-75	71 25-12	

Göttingen Mean Time, Commencement of Observations.			Duration of Observation.	Thermo- meter.	No. of Needle.	MEAN OF READINGS.		A. North <i>Minus</i> B. North.	Observed Dip.	REMARKS.
d.	h.	m.				End A. North.	End B. North.			
Mar. 18	5	25	m.	48.0	1	71 27.37	71 18.00	+ 9.37	71 22.69	
Mar. 21	20	30		45.0	1	71 30.12	71 21.12	+ 9.00	71 25.62	
Mar. 25	5	5		55.0	1	71 30.12	71 9.87	+20.25	71 20.00	
Mar. 28	20	20		45.0	1	71 29.25	71 11.37	+17.88	71 20.31	
Apr. 1	5	20		49.0	1	71 29.37	71 21.87	+ 7.50	71 25.62	
Apr. 4	20	45		44.0	1	71 28.62	71 27.37	+ 1.25	71 28.00	
Apr. 8	5	30		55.0	1	71 24.50	71 18.75	+ 5.75	71 21.62	
Apr. 11	20	45		42.0	1	71 28.87	71 23.87	+ 5.00	71 26.37	
Apr. 15	6	0		47.0	1	71 24.37	71 25.37	- 1.00	71 24.87	
Apr. 18	20	10			1	71 26.12	71 20.87	+ 5.25	71 23.50	
Apr. 22	5	20		62.0	1	71 28.00	71 32.62	- 4.62	71 30.31	This and the previous observations, with the exceptions noted, were made by Mr. Russell. This and the following observations were made by me. J. A. B.
Apr. 25	20	20		49.0	1	71 30.00	71 34.87	- 4.87	71 32.44	
Apr. 29	5	25	65	61.4	1	71 24.62	71 24.87	- 0.25	71 24.75	It is possible that in some of the readings for this observation the divisions of the limb had been taken for 5' instead of 10'. Levelled the agate planes, care being taken that the glass door was shut, as in shutting it exerts a pressure on the bottom of the box. Although great care and much time was bestowed on this observation, it can hardly be considered good, very different readings being obtained after repeatedly lifting the needle on the Y's.
May 6	5	40	160	57.0	1	71 28.12	71 19.62	+ 8.50	71 23.89	
May 9	20	20	100	47.2	1	71 32.37	71 25.87	+ 6.50	71 29.12	Level of agate planes verified. In this observation the needle was placed carefully on the agates, lifted by the Y's, gently let down and allowed to vibrate through about 10°; then, when at rest, read. This observation made in the same way as last. Level of agates verified.
May 13	6	20	85	63.1	1	71 28.25	71 18.37	+ 9.88	71 23.31	
May 16	20	10	55	55.0	1	71 23.87	71 17.25	+ 6.62	71 20.56	The observations of June 3 ^d were made in order to determine the effect, on the final result, of lifting the needle on the Y's one, two, or three times. See Note below. While changing the poles the needle fell upon the carpet from a height of about two feet. This result obtained in the same way as the second result, June 3 ^d . Id. In some of the readings the needle had to be lifted frequently before a satisfactory observation could be made. Allowing the needle to vibrate through 10° has not been found satisfactory. The needle is now checked near its supposed position of rest, and is lifted and lowered by the Y's till satisfied that lifting does not alter the reading.
May 20	5	20	85	57.0	1	71 29.50	71 25.62	+ 3.88	71 27.56	
May 23	21	45	60	55.0	1	71 21.87	71 24.87	- 3.00	71 23.37	
May 30	20	15	90	55.5	1	71 31.12	71 15.00	+16.12	71 23.06	
June 3	5	15	120	69.0	1	71 25.87	71 16.12	+ 9.75	71 20.37	
					1	71 31.75	71 15.62	+16.13	71 23.69	
					1	71 30.25	71 15.50	+14.75	71 22.87	
June 6	20	45	120	59.5	1	71 37.88	71 12.00	+25.88	71 24.94	Id. In some of the readings the needle had to be lifted frequently before a satisfactory observation could be made. Allowing the needle to vibrate through 10° has not been found satisfactory. The needle is now checked near its supposed position of rest, and is lifted and lowered by the Y's till satisfied that lifting does not alter the reading.
June 10	5	15	90	65.6	1	71 32.88	71 8.75	+24.13	71 20.81	
June 13	21	30	75	65.0	1	71 32.62	71 16.12	+16.50	71 24.37	Id. In some of the readings the needle had to be lifted frequently before a satisfactory observation could be made. Allowing the needle to vibrate through 10° has not been found satisfactory. The needle is now checked near its supposed position of rest, and is lifted and lowered by the Y's till satisfied that lifting does not alter the reading.
June 17	5	20	100	61.0	1	71 33.12	71 14.00	+19.12	71 23.56	
June 20	20	15	85	60.0	1	71 38.00	71 7.88	+30.12	71 22.94	Great care taken with this observation.
June 24	5	35	105	65.5	1	71 33.88	71 12.50	+21.38	71 23.19	
June 27	20	25	70	56.0	1	71 38.50	71 12.75	+25.75	71 25.56	
July 1	5	20	85	67.3	1	71 36.00	71 12.37	+23.63	71 24.19	
July 4	21	0	85	60.5	1	71 40.38	71 16.12	+24.26	71 28.25	
July 8	7	0	120	61.7	1	71 38.50	71 15.00	+23.50	71 26.75	

June 3^d. The needle was checked so as to allow it, when lowered on the agates, to vibrate through 10°. After coming to rest the position was read. The first result, June 3^d, was obtained from the readings made in this way. After each of the readings for the first result, the needle was lifted by the Y's and lowered gently (the arc of vibration being small) and again read;—these readings give the second result. The needle being lifted, &c., as in the second case, a third result was obtained.

Göttingen Mean Time, Commencement of Observations.	Dura- tion of Observation.	Thermo- meter.	No. of Needle.	MEAN OF READINGS.		A. North <i>Minus</i> B. North.	Observed Dip.	REMARKS.	
				End A. North.	End B. North.				
July 11 20 45	80	59.5	1	71 40.00	71 13.12	+ 26.88	71 26.56	Needle No. 2 taken by mistake.	
July 15 7 10	120	68.5	1	71 33.38	71 14.62	+ 18.76	71 24.00		
July 18 20 40	120	60.0	1	71 37.50	71 12.50	+ 25.00	71 25.00		
July 22 6 20	85	64.3	1	71 33.50	71 14.88	+ 18.62	71 24.19		
July 25 21 10	70	62.1	2	71 15.12	71 40.62	- 25.50	71 27.87		
July 29 6 50	150	61.7	1	71 41.38	71 12.38	+ 29.00	71 26.88		
Aug. 1 20 40	90	63.0	1	71 45.75	71 11.88	+ 33.87	71 28.81		
Aug. 5 6 25	170	66.5	2	71 24.38	71 37.12	- 12.74	71 30.75		This observation is not considered good, though much time was bestowed on it. Owing to the bad balance of the needle, or the action of the lifter, no reading was considered perfectly satisfactory.
Aug. 8 20 20	75	63.2	1	71 32.50	71 22.75	+ 9.75	71 27.62		
Aug. 15 20 30	90	62.5	1	71 28.88	71 23.75	+ 5.13	71 26.31		
Aug. 22 20 35	115	60.8	1	71 44.00	71 15.88	+ 28.12	71 26.19	This observation is scarcely worth recording. No reading could be obtained, after lifting and lowering the needle, the same as before. The greatest care was taken, and the readings, in each position, made from 6 to 10 times before one was adopted.	
Aug. 29 20 30	105	63.0	1	71 27.50	71 12.75	+ 14.75	71 20.12		
Sept. 2 6 35	30	66.1	1	71 35.62	71 18.25	+ 17.37	71 26.94	Considered a good observation, though made in a comparatively short time.	
Sept. 5 20 29	50	58.0	1	71 36.00	71 14.50	+ 21.50	71 25.25		
Sept. 9 6 20	60	63.0	1	71 35.00	71 13.00	+ 22.00	71 24.00		
Sept. 12 20 25	40	54.3	1	71 33.62	71 13.25	+ 20.37	71 23.44		
Sept. 16 6 40	40	65.9	1	71 36.12	71 12.38	+ 23.74	71 24.25		
Sept. 19 21 20	25	54.0	1	71 37.88	71 12.12	+ 25.76	71 25.00		
Sept. 23 6 10	35	59.0	1	71 36.38	71 11.62	+ 24.76	71 24.00		
Sept. 26 20 25	25	51.0	1	71 36.38	71 15.25	+ 21.13	71 25.81		
Sept. 30 6 10	25	55.0	1	71 36.12	71 13.00	+ 23.12	71 24.56		
Oct. 3 20 25	25	41.8	1	71 35.75	71 11.37	+ 24.38	71 23.56		
Oct. 7 5 25	20	57.3	1	71 33.88	71 11.62	+ 22.26	71 22.55		All the observations since August 29. are considered very good,—none of them were hurried.
Oct. 10 20 20	25	53.8	1	71 33.00	71 11.25	+ 21.75	71 22.12		
Oct. 14 5 25	25	57.8	1	71 32.75	71 12.00	+ 20.75	71 22.38		
Oct. 17 20 45	20	45.4	1	71 34.88	71 9.75	+ 25.13	71 22.31	In changing the poles the needle received, by mistake, 10 strokes instead of 8 on each side. This observation made by candle light, and is not considered so good as the others.	
Oct. 24 20 25	25	36.8	1	71 34.00	71 10.62	+ 23.38	71 22.31		
Oct. 28 5 30	40	53.5	1	71 35.38	71 13.50	+ 21.88	71 24.44	Observation not quite satisfactory. Instrument levelled. A considerable change took place in the readings on this occasion, compared with those in the same positions previously. Good observation.	
Oct. 31 20 30	25	55.3	1	71 33.25	71 11.88	+ 21.37	71 22.56		
Nov. 4 5 20	25	54.2	1	71 32.25	71 10.12	+ 22.13	71 21.17	Good observation.	
Nov. 7 21 5	30	50.3	1	71 32.38	71 9.62	+ 22.76	71 21.00		
Nov. 11 5 50	30	55.8	1	71 30.75	71 5.50	+ 25.25	71 18.12	Considered a fair observation.	
Nov. 14 21 0	35	47.0	1	71 34.62	71 8.25	+ 25.37	71 21.44		
Nov. 18 5 25	40	54.6	1	71 25.88	71 7.12	+ 18.76	71 16.50	Good observation.	
Nov. 28 20 35	40	54.0	1	71 32.75	71 9.12	+ 23.63	71 20.94		
Dec. 5 23 20	30	55.0	1	71 31.75	71 8.75	+ 23.00	71 20.25	Fair observation.	
Dec. 12 20 35	40	58.2	1	71 35.62	71 10.25	+ 24.37	71 22.94		
Dec. 15 5 35	25	60.0	1	71 35.75	71 9.88	+ 25.87	71 22.81	Good observation.	
Dec. 19 20 35	35	53.5	1	71 31.62	71 11.62	+ 20.00	71 21.62		
Dec. 26 20 50	50	48.5	1	71 32.50	71 7.88	+ 25.62	71 20.19	Good observation. Observed by Mr. Welsh.	
Dec. 30 5 50	60	61.7	1	71 29.12	71 11.25	+ 17.87	71 20.19		

OBSERVATION

OF

ABSOLUTE HORIZONTAL INTENSITY.

MARCH 26. 1842.

OBSERVATIONS OF DEFLECTION.				BIFILAR MAGNETOMETER.		OBSERVATIONS OF VIBRATION.				BIFILAR MAGNETOMETER.								
DEFLECTING BAR.		Mean Readings of Suspended Magnet.	Mean Deflection.	Readings.	Thermometer.	S. End Moving W.		60 Vibrations.	S. End Moving E.		60 Vibrations.	Time of Observation.	Readings.	Thermometer.				
Distance.	N. End.					h.	m.		s.	m.					s.	h.	m.	s.
5.25 W.	W.	36.61	212.37	153.9	54.0	3	16	33.0		3	16	49.0		3	18	30	161.5	56.0
	E.	461.34		150.3	54.4	21	35.4	21		51.0	21	0		166.6	56.0			
8.50 W.	E.	308.13	60.57	156.2	55.2	26	37.3	15	6.4	26	53.0	15	6.3	23	30	166.8	56.0	
	W.	186.98		149.2	54.8	31	39.4		31	55.3	26		0	166.0	56.0			
8.50 E.	E.	307.09	59.87	151.2	55.8	36	41.6	15	6.2	36	57.4	15	6.4	28	30	164.5	55.9	
	W.	187.35		152.3	56.0	41	43.6		41	59.4	31		0	162.3	55.9			
5.25 E.	W.	35.45	211.61	151.3	56.2	46	45.9	15	6.5	47	1.6	15	6.3	33	30	162.2	55.8	
	E.	458.68		153.1	56.3						36		0	159.5	55.7			
											38		30	160.0	55.7			
											41		0	160.4	55.6			
													43	30	158.7	55.5		
													46	0	156.4	55.4		

$r = 5.25$ feet. Mean deflection 211.99 Sc. Div. $u = 2^\circ 22' 14''.7$
 $r' = 8.50 \dots \dots \dots 60.22 \dots \dots \dots u' = 0^\circ 40' 24''.4$

Observed mean time of one vibration, $T = 15^s.1058$.

Mean Bifilar, $\left\{ \begin{matrix} \text{Reading} \\ \text{Thermom.} \end{matrix} \right\}$ during deflections, $\left\{ \begin{matrix} 152.2^{div.} \\ 55^\circ.35 \end{matrix} \right\}$ Reading corrected, 523.8^{div.}

Mean Bifilar, $\left\{ \begin{matrix} \text{Reading} \\ \text{Thermom.} \end{matrix} \right\}$ during vibrations, $\left\{ \begin{matrix} 162.1^{div.} \\ 55^\circ.8 \end{matrix} \right\}$ Reading corrected, 534.8^{div.}

Difference of Bifilar readings during deflections and vibrations corrected = $\frac{\Delta X}{X} + \frac{\Delta m}{m} = 11.0$ Sc. div.
 = .00137 in parts of force.

$\frac{H}{F} = 0.000994$. (See *Introduction* for value of $\frac{H}{F}$, March 3. 1842.)

Semi arc $\left\{ \begin{matrix} \text{at commencement} \\ \text{at termination} \end{matrix} \right\}$ of vibrations, $\left\{ \begin{matrix} \alpha = 10^\circ \\ \alpha' = 6^\circ \end{matrix} \right\}$

Deflecting bar, $\left\{ \begin{matrix} \text{Length, } a = 1.25 \text{ feet,} \\ \text{Breadth, } b = 0.0719 \text{ feet,} \\ \text{Weight, } W = 6216.7 \text{ grains.} \end{matrix} \right\}$

From the formulæ below there has been obtained $X = 2.9662$.

$$\text{Moment of inertia } K = \frac{a^2 + b^2}{12} W.$$

$$T \left(1 + \frac{H}{2F} - \frac{a \alpha'}{16} \right) = T, \text{ time of vibration corrected.}$$

$$\frac{\pi^2 K}{T^2} \left(1 + \frac{\Delta X}{X} + \frac{\Delta m}{m} \right) = m X \text{ at the period of deflections.}$$

$$\left(1 + \frac{H}{F} \right) \cdot \frac{r'^5 \tan \alpha' - r^5 \tan \alpha}{2 (r'^2 - r^2)} = \frac{m}{X}.$$

The hours of the deflection observations have not been registered.

The arcs of vibration were not registered. The above have been estimated from a remembrance that Mr. Russell used rather large arcs of vibration, and from other considerations. The times of vibration were obtained from the clock in the observatory; the rate is not registered, but it was generally very small.

The notation and formulæ above are those used in the Report of the Royal Society.

DAILY METEOROLOGICAL
OBSERVATIONS.

1841 AND 1842.

Göttingen Mean Time of Observation.		BARO- METER Corrected.	THERMOMETERS.			RAIN GAUGE B.	STATE OF THE SKY.
			Dry.	Wet.	Max. and Min.		
d.	h.	in.	°	°	°	in.	
July	11	20	29.290		
		23	29.313		
July	12	2	29.322		
		5	29.306		
		20	29.365	51.4	48.9	63.1	
		23	29.381	55.7	50.2	46.3	0.02
July	13	2	29.396	55.5	49.7		
		5	29.393	56.4	51.3		
		20	29.426	52.6	51.5	57.6	
		23	29.400	56.6	52.3	49.9	0.35
July	14	2	29.414	58.5	54.4		
		5	29.416	55.9	53.4		
		20	29.431	53.2	51.8	59.0	
		23	29.453	53.3	52.5	50.1	0.54
July	15	2	29.503	56.8	53.6		
		5	29.550	58.4	53.9		
		20	29.770	48.7	45.6	59.9	
		23	29.785	52.7	47.6	47.8	0.04
July	16	2	29.758	58.1	51.7		
		5	29.740	60.8	54.7		
		20	29.712	54.6	48.6	61.5	
		23	29.637	59.3	51.0	42.2	0.00
July	17	2	29.683	62.0	55.4		
		5	29.635	63.2	55.5		
July	18	20	65.7	
		23	29.552	62.2	56.1	53.2	0.02
July	19	2	29.535	67.4	58.0		
		5	29.512	62.6	58.0		
		20	29.395	54.2	52.0	69.7	
		23	29.344	60.5	56.0	45.5	0.20
July	20	2	29.266	61.5	54.4		
		5	29.236	58.2	54.1		
		20	29.177	54.3	52.7	63.6	
		23	29.176	56.2	53.9	52.5	0.47
July	21	2	29.184	58.8	54.2		
		5	29.242	59.7	55.5		
		20	29.349	54.4	49.7		
		23	29.401	53.7	50.6	48.6?	0.00
July	22	2	29.462	56.5	52.4		
		5	29.511	56.2	52.0		
		20	60.6	
		23	29.728	52.2	50.3	51.3	0.01
July	23	2	29.779	53.2	51.4		
		5	29.819	54.5	50.8		
Aug.	4	20	29.372	51.7	50.7	63.9	
		23	29.308	55.5	54.4	49.5	0.27
Aug.	5	2	29.237	60.8	58.1		Rain.
		5	29.140	63.2	60.2		Id. Cloudy. Heavy rain.

The maximum and minimum temperatures given, with exceptions noted, are the greatest and least which have occurred since the previous observation. The register thermometers were read between 20^h and 23^h.

The quantity of rain is always the quantity fallen since the previous observation. The gauge was read at 1^h.

Aug. 4^d 21^h. The maximum and minimum temperatures given are supposed to be those of the preceding 24 hours.

Göttingen Mean Time of Observation.		BARO- METER Corrected.	THERMOMETERS.			RAIN GAUGE B.	STATE OF THE SKY.
			Dry.	Wet.	Max. and Min.		
Aug. 5	d. 20	in. 29.104	° 58.3	° 56.5	° 63.5	0.34	Cloudy. Id. : light rain.
	h. 23	29.180	57.5	54.4	54.2		
Aug. 6	d. 2	29.269	59.1	54.7			Id. : sunshine at intervals. Id.
	h. 5	29.336	56.7	52.8			
	20	29.449	57.2	54.7	59.4	0.00	Fair : wind WSW. Id. : wind WSW.
	23	29.459	62.9	58.4	48.5		
Aug. 7	d. 2	29.461	59.8	57.1			Thick clouds : wind S. Fair : wind SW.
	h. 5	29.439	62.4	58.2			
Aug. 8	d. 20	29.275	55.2	52.1	64.2	0.64	Fair.
	h. 23	29.254	58.4	53.2	45.6		
Aug. 9	d. 2	29.175	58.1	53.9			Fine and clear ; heavy showers at intervals. Cloudy.
	h. 5	29.232	57.5	51.2			
	20	59.9	0.01	
	23	29.361	56.3	51.9	47.5		
Aug. 10	d. 2	29.402	57.8	51.9			Cloudy. Id.
	h. 5	29.422	58.8	53.4			
	20	29.394	48.0	45.7	59.1	0.00	Id. : high wind. Id. : id.
	23	29.374	54.7	51.8	40.7		
Aug. 11	d. 2	29.374	54.7	51.7			
	h. 5	29.369	54.7	50.8			
	20	29.548	52.4	46.6	55.1	0.00	
	23	29.569	55.7	48.7	43.4		
Aug. 12	d. 2	29.591	58.5	50.7			Fine and clear. Cloudy.
	h. 5	29.596	57.2	50.8			
	20	29.564	47.5	45.4	59.3	0.00	Heavy clouds : light rain. Rain.
	23	29.545	59.5	54.6	37.3		
Aug. 13	d. 2	29.539	59.0	55.0			Rain.
	h. 5	29.489	56.9	55.1			
	20	29.321	54.4	53.2	63.2	0.37	Id. Clouds breaking. Heavy rain.
	23	29.292	55.9	55.1	52.4		
Aug. 14	d. 2	29.305	57.4	56.0			Fair.
	h. 5	29.315	57.0	55.9			
Aug. 15	d. 20	29.622	51.2	50.0	66.7	0.33	Id. Id.
	h. 23	29.618	61.1	58.3	44.0		
Aug. 16	d. 2	29.613	67.0	62.1			Fair but cloudy.
	h. 5	29.553	64.5	59.7			
	20	29.495	58.8	56.9	67.3	0.00	Light rain. Fair.
	23	29.552	58.4	52.9	55.1		
Aug. 17	d. 2	29.640	60.0	52.5			Id. : fresh breeze.
	h. 5	29.707	60.0	51.4			
	20	29.903	49.6	47.5	61.1	0.00	Fair. Id. Id.
	23	29.916	61.0	56.4	40.0		
Aug. 18	d. 2	29.913	61.4	54.8			Fair and clear. Fair : cloudy.
	h. 5	29.912	61.1	55.2			
	20	29.854	55.8	52.6	63.0	0.00	Fair : cloudy.
	23	29.850	62.3	57.7		
Aug. 19	d. 2			Heavy clouds.
	h. 5	29.823	63.4	60.1			
	20	29.679	60.8	59.0	67.1	0.00	Fair : hazy. Id. : id. Id. : id.
	23	29.606	62.5	58.6	54.0		
Aug. 20	d. 2	29.510	69.4	61.2			Id. : cloudy.
	h. 5	29.488	70.4	62.4			

Göttingen Mean Time of Observation.		BARO- METER Corrected.	THERMOMETERS.			RAIN GAUGE B.	STATE OF THE SKY.
			Dry.	Wet.	Max. and Min.		
d.	h.	in.	°	°	°	in.	
Aug. 20	20	29.450	53.3	52.1	71.5		Rain.
	23	29.409	51.6	50.8	51.3	0.46	Very heavy rain : thunder.
Aug. 21	2	29.372	55.3	53.7			Drizzling rain.
	5	29.347	53.3	52.1			Id.
Aug. 22	20	29.420	52.8	50.0	63.2		Fair.
	23	29.467	57.9	52.0	47.5	0.46	Id.
Aug. 23	2	29.525	58.6	51.7			Id.
	5	29.583	59.2	52.9			Id.
	20	29.817	49.4	48.1	60.4		Light rain.
	23	29.847	53.8	50.3	42.4	0.02	Cloudy.
Aug. 24	2	29.836	56.4	52.5			Fair but cloudy.
	5	29.838	57.8	53.7			Fair and clear.
	20	29.686	56.7	55.0	60.1		Fair : nimbi to W. : cumuli to E.
	23	29.662	62.5	59.0	50.1	0.17	Heavy cumuli approaching to nimbi.
Aug. 25	2	29.723	66.3	60.5			Dense scud : gleams of sunshine.
	5	29.737	65.0	60.9			Cumuli : scud.
	20	29.722	61.8	60.2	67.3		Light rain : scud : wind.
	23	29.740	65.8	62.8	55.6	0.00	Heavy cumuli.
Aug. 26	2	29.847	65.0	62.4			Heavy cumuli and scud.
	5	29.894	64.9	60.6			Cumuli : fair.
	20	29.916	59.6	57.0	67.2		Cumuli.
	23	29.910	61.8	59.3	56.8	0.01	Id.
Aug. 27	2	29.899	65.5	60.6			Id. : wind.
	5	29.836	63.7	58.9			Id. : id.
	20	29.845	58.2	56.8		Overcast : light rain : gleams of sunshine.
	23	29.861	62.1	57.3	0.00	Id. : heavy cum. : light wind.
Aug. 28	2	29.833	64.2	56.4			Fair : scattered cum. : light breeze.
	5	29.846	64.0	56.6			Id. : id. : occasional gusts of wind.
Aug. 31	20	29.663	43.6	42.6	55.8		Fair : cumuli on horizon : heavy dew.
	23	29.647	57.0	53.0	37.4	0.50	Id. : clouds rising : misty : solar halo at 22 ^h .
Sept. 1	2	29.625	59.3	54.6			Sky much overcast : dark cumuli : wind rising.
	5	29.586	56.9	51.5			Sky almost covered with dark clouds : wind high.
	20	29.464	54.3	50.7	59.6		Fair : cum.-str. on horizon : cir.-haze above.
	23	29.434	59.8	54.8	51.2	0.00	Id. : sky much overcast : cum.-str. on hor. : wind very high.
Sept. 2	2	29.386	61.6	55.6			Sky much overcast with heavy cum : wind high.
	5	29.384	60.3	54.7			Overcast : dark cum. : brighter to W. : wind very high.
	20	29.468	49.7	48.8	62.5		Overcast : cum. in zenith : cum.-str. on horizon.
	23	47.1	0.00	
Sept. 3	2			
	5			
	20	29.460	46.4	45.0	59.3		Sky quite overcast : heavy rain.
	23	29.456	45.9	43.8	45.4	0.13	Id. : id.
Sept. 4	2	29.490	45.1	43.8			Overcast : steady rain : clearing to NW.
	5	29.482	45.5	43.9			Clouds more broken up : gleams of sunshine.
Sept. 5	20	29.564	40.5	39.2	55.6		Fine : cum. generally : cum.-str. on E. hor : clear to NW.
	23	29.553	51.5	47.6	35.1	0.13	Overcast from N. to zen. : light rain : cum.-str. on N. hor. : broken to S. : gleams of sunshine.
Sept. 6	2	29.538	55.3	51.0			Generally overcast : clouds broken : cum. : clearing on N. hor.
	5	29.491	56.9	52.0			Clear to N. : detached and scattered cum. : cir.-cum.

Aug. 31^d. The maximum and minimum here given are supposed to be those of the 31st. In cases of omission Mr. Russell does not mention when the register thermometers are set.

Göttingen Mean Time of Observation.		BARO- METER Corrected.	THERMOMETERS.			RAIN GAUGE B.	STATE OF THE SKY.
			Dry.	Wet.	Max. and Min.		
Sept. 6	d. 20	in. 29-480	° 40.2	° 39.4	° 57.3	in.	Fine : cir., cir.-str. : cum. to SW. : clear to E. and N.
	23	29-448	52.5	49.1	35.5	0.00	Much overcast : heavy cum. : bright gleams of sunshine.
Sept. 7	2	29-375	53.7	50.6			Sky quite overcast with heavy cumuli.
	5	29-304	55.4	52.3			Still overcast : clouds more broken : cum., cum.-str. on hor.
Sept. 8	20	29-307	49.8	49.0	55.9		Unbroken clouds : light rain.
	23	29-355	53.2	52.0	48.3	0.34	Still overcast : clouds broken : light rain.
Sept. 8	2	29-413	54.9	52.9			Id. : id. : id.
	5	29-522	51.6	49.8			Id. : clouds less broken : fair.
Sept. 9	20	29-762	42.6	41.9	55.1		Thick fog.
	23	29-720	52.2	50.8	36.9	0.02	Much overcast : cum. : gleams of sunshine.
Sept. 9	2	29-693	58.6	56.7			Quite overcast, with almost unbroken clouds : light rain.
	5	29-650	58.8	57.2			Id. : id. : id.
Sept. 10	20	29-623	58.7	56.8	61.1		Fair : sky covered with detached cum. : cum.-str. on hor.
	23	29-621	61.8	59.7	51.6	0.01	Quite overcast with cum. : cum.-str. on SW. hor.
Sept. 10	2	29-592	63.5	62.3			Sky covered with unbroken clouds : rain.
	5	29-588	61.4	60.3			Id. : id.
Sept. 11	20	29-696	54.2	53.3	65.3		Fair : cum to S. : clear in zen. : cir.-str. to N. and E.
	23	29-737	61.4	57.4	53.3	0.12	Id. : cum. generally : cir.-str.
Sept. 11	2	29-770	63.9	59.2			Id. : sky covered with broken clouds.
	5			
Sept. 12	20	29-717	54.9	53.8	75.6		Fine : clear : cirri.
	23	29-737	66.9	62.5	51.2	0.00	Id. : id. : id.
Sept. 13	2	29-744	72.0	67.8			Id. : id. : id.
	5	29-722	70.9	63.8			Id. : id. : id.
Sept. 14	20	29-591	58.8	56.8	68.1		Fine and clear : a few cum. on hor. : cir. here and there.
	23	29-588	64.2	58.5	55.3	0.09	Almost clear : a few cum. : strong breeze.
Sept. 15	2	29-674	67.5	60.5			Many cumuli : strong breeze.
	5	29-556	65.1	60.3			Id. : wind abated.
Sept. 16	20	29-543	55.7	53.7	69.0		Fine and clear : cir., cir.-cum.
	23	29-534	62.2	57.8	52.7	0.03	Fair, cumuli, cirri.
Sept. 16	2	29-510	61.4	58.6			Id., cum. : storm passed off to NE. : dense clouds still seen there.
	5	29-549	63.0	58.0			Id., id : occasional thunder in horizon.
Sept. 17	20	29-707	46.8	45.9	65.3		Fog ; apparently clear above.
	23	29-714	57.9	55.7	43.2	0.16	Fine and clear : a few cum. on hor.
Sept. 17	2	29-716	62.5	58.7			Fine : many cumuli.
	5	29-705	63.3	59.6			Clear : cum.-str. on hor.
Sept. 18	20	29-771	46.4	45.6	64.2		Thick fog.
	23	29-780	51.1	49.6	42.4	0.00	Id.
Sept. 18	2	29-743	56.2	54.3			Sky overcast : misty.
	5	29-749	55.7	54.2			Id.
Sept. 19	20	57.1		Thick fog.
	23	29-878	56.7	55.1	50.7	0.00	Fine : fog clearing off : cumuli.
Sept. 19	2	29-880	61.3	58.8			Id. : cumuli : cum.-str. on hor.
	5	29-874	62.3	58.9			Id. : id. : cir.-cum.
Sept. 20	20	29-999	56.4	55.8	63.7		Quite overcast.
	23	30-031	58.3	55.8	54.6	0.00	Overcast : heavy dark clouds.
Sept. 20	2	30-030	58.6	56.3			Id. : id.
	5	30-038	57.0	54.7			Id. : id. : wind rising.

Göttingen Mean Time of Observation.		BARO- METER Corrected.	THERMOMETERS.			RAIN GAUGE B.	STATE OF THE SKY.	
			Dry.	Wet.	Max. and Min.			
d.	h.	in.	°	°	°	in.		
Sept.	20	20	30.021	48.4	47.6	58.9		Fine and generally clear : cumuli.
		32	30.006	54.2	50.6	45.8	0.00	Much overcast : heavy dark clouds.
Sept.	21	2	29.947	56.3	49.4			Fine : many cum. : wind rather high.
		5	29.897	54.7	46.1			Id. : cum. : cum.-str.
		20	29.688	51.3	49.0	58.1		Much overcast : cum. : wind.
		23	29.662	53.9	49.3	45.3	0.00	Id. : id. : id.
Sept.	22	2	29.598	54.0	49.5			Quite overcast : id.
		5	29.530	52.9	49.8			Id. : less wind.
		20	29.396	51.7	50.4		Overcast.
		23	29.390	55.0	53.6	0.11	Id.
Sept.	23	2	29.359	56.7	55.7			Id. : light rain : cum. : scud.
		5	29.370	58.3	56.0			Clearer sky : cum. : cir.
		20			
		23	29.327	56.3	54.7	59.2	0.05	Quite overcast : light rain.
Sept.	24	2	29.337	53.6	52.5	49.3		Unbroken clouds : heavy rain.
		5	29.329	54.4	52.8			Id. : light rain.
		20	29.216	51.7	51.0	56.6		Overcast : rain.
		23	29.160	53.1	51.0	49.8	0.74	Id. : id.
Sept.	25	2	29.099	55.5	53.5			Clouds more broken : cum. : scud.
		5	29.139	54.4	52.3			Id. : id.
Sept.	26	20	29.296	44.6	44.0	60.1		Fog.
		23	29.307	48.2	47.0	41.0	0.07	Id.
Sept.	27	2	29.286	52.1	50.1			Still foggy : sun breaking through.
		5	29.287	55.8	54.7			Fine and clear : cirri.
		20	28.880	52.7	52.1	56.3		[from NE.
		23	28.886	59.5	56.8	47.3	0.07	Heavy clouds to S. (windward) : cir. : cir.-cum. to N. : cir.-str.
Sept.	28	2	28.843	61.6	57.4			Scattered cum. : strong breeze : sunshine.
		5	28.866	57.1	54.3			Cum. : varieties of cir. : cir.-cum. : cir.-str. : sunshine : wind.
		20	28.484	52.5	51.7	63.2		Much overcast : clouds broken to W. : gleams of sunshine.
		23	28.607	53.0	50.3	50.3	0.73	Quite overcast : heavy rain : high wind.
Sept.	29	2	28.646	56.3	53.4			Clearer to S. : cum. : nimb. to N. : sunshine : wind.
		5	28.693	56.8	53.0			Overcast : rain and wind.
		20	28.883	52.4	50.8	56.6		Sky more open : heavy clouds to S. : wind.
		23	28.857	55.6	53.2	51.0	0.06	Overcast : light rain.
Sept.	30	2	28.886	58.3	52.8			More open : scattered cum. : sunshine.
		5	28.930	56.1	51.1			Id., but wild : scattered cum. : cum.-str. on hor. : wind.
Oct.	6	20	28.736	49.2	47.9	51.3		As before : heavy clouds to W.
		23	28.733	50.3	49.4	47.3	2.58	Heavy rain : wind.
Oct.	7	2	28.669	51.9	50.9			Id. : id.
		5	28.752	51.7	50.9			Id. : id.
		20	29.033	49.5	48.8	52.7		Overcast : fair : wind not so high.
		23	29.083	50.3	49.4	47.3	0.47	Rather open to N. : cir.-cum. : dense clouds to S.
Oct.	8	2	29.129	50.9	49.4			Overcast : wind : rain.
		5	29.206	50.6	48.5			Heavy clouds to S. : a little broken to N. : gleams of sunshine.
		20	29.408	46.2	45.5	51.9		Quite overcast.
		23	29.432	51.2	48.9	43.1	0.02	Overcast : cum.-str. on hor. : calm.
Oct.	9	2	29.454	54.0	50.3			Thick scud in zen. : clear elsewhere : cum.-str. on hor.
		5	29.458	53.0	51.8			Cloudy : cumuli.
								Id. : id.

Oct. 6^d. The maximum and minimum are supposed to be those of the preceding 24 hours. See note on the quantity of rain, page 68.

Göttingen Mean Time of Observation.		BARO- METER Corrected.	THERMOMETERS.			RAIN GAUGE B.	STATE OF THE SKY.
			Dry.	Wet.	Max. and Min.		
d. h.	in.	°	°	°	in.		
Oct. 10	20	29.111	47.1	43.8	54.9		Clear : cir. : dark heavy clouds on NE. hor.
	23	29.148	50.1	45.5	41.7	0.07	Clear : a few cumuli : wind.
Oct. 11	2	29.150	53.1	47.5			Fair : cumuli : cir.-cum.
	5	29.050	50.9	48.8			Overcast.
	20	29.026	37.1	36.9	53.5		Fair : cirri : cum. on E. horizon.
	23	29.032	44.4	43.0	35.3	0.05	Id. : overcast.
Oct. 12	2	29.070	51.0	48.8			A good deal overcast : sun between broken clouds.
	5	29.131	51.9	48.5			Cumuli : heavy dark clouds to W.
	20	29.511	42.0	38.9	53.5		Cumuli : dark clouds to SE.
	23	29.639	43.2	39.8	36.1	0.00	Clear to W. : cum to E. : calm.
Oct. 13	2	29.633	45.8	41.7			Overcast : cir.-str. : cumuli on hor.
	5	29.638	44.8	41.8			Overcast : rain.
	20	29.293	50.0	48.8	55.9		Overcast : dark clouds to eastward.
	23	29.295	55.0	51.0	42.4	0.16	Clear in zenith : cum. to W. : heavy clouds to E.
Oct. 14	2	29.282	52.9	50.1			Sunshine : cloudy to eastward.
	5	29.261	53.0	49.9			Overcast : rain : heavy clouds to W.
	20	29.053	48.0	47.1	55.3		Overcast : rain.
	23	29.197	46.0	44.3	39.4	0.26	Id.
Oct. 15	2	29.321	44.8	42.4			Id. : rain : wind NW.
	5	29.397	43.4	41.8			Id. : breaking to westward.
	20	29.173	41.0	40.0	49.0		Id. : rain.
	23	29.068	41.2	39.9	39.2	0.21	Id. : id.
Oct. 16	2	29.010	42.8	41.7			Id. : id.
	5	29.120	43.2	41.7			Id. : id.
Oct. 17	20	29.281	40.2	37.5	53.5		Fair and clear : cir. : cum. on hor.
	23	29.435	40.9	38.2	37.7	0.20	Id. : cir.-str.
Oct. 18	2	29.510	44.2	38.3			Zenith clear : cum. on horizon.
	5	29.499	42.7	38.7			Id. : cir.-str.
	20	29.457	32.7	32.2	53.5		Fine and clear : frost.
	23	29.444	43.5	40.9	30.8	0.00	Fair : cirri : cir.-str.
Oct. 19	2	29.405	47.6	44.5			Nimbus : shower of rain : cirri.
	5	29.441	46.6	43.7			Heavy clouds, sun between.
	20	29.300	45.2	42.7	53.1		Overcast : broken to eastward.
	23	29.225	48.6	45.4	42.3	0.00	Heavy cumuli : sunshine : wind.
Oct. 20	2	29.135	48.1	45.2			Overcast.
	5	29.027	45.6	43.7			Id.
	20	29.456	33.7	31.1	49.5		Fair : cumuli.
	23	29.561	37.2	34.0	32.0	0.20	Id. : clear.
Oct. 21	2	29.628	41.0	37.0			Id. : id.
	5	29.682	39.6	36.8			Id. : cir. and cir.-str.
	20	42.0		
	23	29.791	37.2	35.8	30.0	0.00	Overcast : cum.-str. on E. hor.
Oct. 22	2	29.712	44.8	41.8			Id. : id. : id.
	5	29.632	43.9	42.4			Id.
	20	29.195	42.3	41.5	45.5		Overcast : cum. : cir.-str. on hor.
	23	29.083	44.9	43.3	40.2	0.06	Id. : light rain : strong breeze.
Oct. 23	2	28.963	45.8	44.0			Id. : id. : id.
	5	28.820	45.4	44.5			More open : scattered heavy clouds : zenith clear.

Göttingen Mean Time of Observation.		BARO- METER Corrected.	THERMOMETERS.			RAIN GAUGE B.	STATE OF THE SKY.	
			Dry	Wet.	Max. and Min.			
d	h.	in.	°	°	°	in.		
Oct.	24	20	28.913	42.3	40.4	48.5	0.25	Much overcast : cum. : cir.-cum.
		23	28.989	43.6	40.8	36.6		Id. : broken clouds : brisk gale.
Oct.	25	2	28.977	45.3	42.1	0.01	Id. : id. : id. : wild sky.	
		5	29.118	41.5	39.5		Storm of wind and rain.	
Oct.		20	29.353	37.5	35.8	45.5	0.01	Clear : cirri : dark cumuli on horizon.
		23	29.362	41.5	40.0	36.6		Rather open sky : cum. : cirri.
	26	2	29.440	44.5	41.3	0.20		Broken heavy cum. : scud : a few drops of rain.
		5	29.505	41.5	39.0			Clear above : cumuli on horizon.
Oct.		20	29.677	38.6	37.5	45.0	0.20	Overcast : clouds broken to E. : rain : wind.
		23	29.654	43.1	39.5	36.5		Id. : wind. [high wind.
	27	2	29.593	42.6	39.5	0.01		Cum. : frequent showers : three rainbows seen during one hour :
		5	29.605	41.8	38.8			High wind : rain.
Oct.		20	29.747	40.5	39.0	44.6	0.01	Fair : detached cumuli.
		23	29.790	44.5	40.5	39.2		Overcast : gleams of sunshine.
	28	2	29.697	46.8	42.2	0.00		Zenith clear : ranges of cum. on hor.
		5	29.831	43.8	41.7			Cir.-str. to S. : linear cirri : cum. to N.
Oct.		20	29.938	37.8	36.9	46.8	0.00	Fair : overcast : cumuli.
		23	29.936	44.3	41.8	31.0		Cumuli : sunshine.
	29	2	29.947	46.9	43.5	0.00		A good deal overcast : cir.-str. on E. horizon.
		5	29.956	44.5	41.4			Overcast : cumuli.
Oct.		20	29.984	42.9	39.8	42.2	0.00	Fair : overcast : cumuli.
		23	29.965	44.9	40.5	46.5		Overcast : wind.
	30	2	29.903	44.9	41.0	0.12		Id. : id.
		5	29.889	43.5	42.3			Id. : rain.
Oct.	31	20	29.710	41.6	40.9	48.5	0.12	Overcast : light rain.
		23	29.756	44.9	43.7	40.0		Id. : id. : clearing to N.
Nov.	1	2	29.796	45.9	44.7	0.03	Id. : id.	
		5	29.817	45.9	43.8		Id. : breaking to westward.	
Nov.		20	30.040	30.0	46.9	0.03	Fine and clear.
		23	30.062	34.9	32.0	29.0		Id. :
	2	2	30.024	42.3	40.8	0.00		Id. :
		5	30.040	41.5	41.2			Fine : cirri : cir.-cum.
Nov.		20	30.094	35.8	35.4	44.5	0.00	Fair : cir.-cum. : cum. to eastward.
		23	30.136	40.3	39.4	33.9		Overcast : cir.-str. on E. horizon.
	3	2	30.134	44.5	43.4	0.00		Id. : id.
		5	30.133	43.8	43.5			Hazy to E. : clear with cirri to W.
Nov.		20	30.239	31.9	31.8	46.0	0.00	Foggy : clouds where seen, cumuli.
		23	30.246	32.5	32.4	30.8		Fog clearing off : zenith clear.
	4	2	30.210	39.0	38.3	0.00		Fair : clear : cirri.
		5	30.197	40.0	39.6			Clear.
Nov.		20	30.174	33.3	33.1	41.1	0.00	Overcast.
		23	30.149	36.4	35.7	29.8		Id.
	5	2	30.138	40.7	39.7	0.01		Id.
		5	30.118	42.7	41.9			Id.
Nov.	7	20	29.907	48.5	46.6	52.5	0.01	Fine and clear : cumuli on S. horizon.
		23	29.938	50.8	48.5	35.6		Overcast : many cumuli.
Nov.	8	2	29.954	52.8	49.9	0.01	Id. : dark heavy cumuli.	
		5	29.964	49.3	47.3		Id.	

Göttingen Mean Time of Observation.		BARO- METER Corrected.	THERMOMETERS.			RAIN GAUGE B.	STATE OF THE SKY.
			Dry.	Wet.	Max. and Min.		
d.	h.	in.	°	°	°	in.	
Nov. 8	20	29.840	48.5	46.9	53.7		Overcast : cum. : wind : scud flying low.
	23	29.746	49.4	47.6	47.3	0.00	Id. : wind.
Nov. 9	2	29.796	48.9	46.9			Id. : id.
	5	29.692	48.9	46.6			Id. : id.
	20	29.620	48.8	45.9	52.5		Many cum. : a few cir.-str. to E. : wind.
	23	29.617	51.8	47.4	48.3	0.00	Id. : id.
Nov. 10	2	29.650	51.9	47.4			Rain : nimbi : clear to NW.
	5	29.635	48.1	44.8			Overcast : cumuli.
	20	29.650	40.5	37.8	51.6		Fair and clear : cum. on S. hor.
	23	29.676	41.5	38.2	38.9	0.00	Id. : cir.-cum.
Nov. 11	2	29.644	44.5	39.5			Id. : id. : cum.
	5	29.709	40.8	38.9			More overcast : cumuli.
	20	29.305	37.5	36.5	44.9		Overcast : cum. : cum.-str.
	23	29.186	39.4	38.5	32.2	0.19	Id. : light rain, but clearing.
Nov. 12	2	29.092	40.6	39.5			Id. : id., clearing to W.
	5	29.020	37.6	35.9			Id. : clearer to W.
	20	29.088	32.5	31.9	41.2		Overcast : cumuli.
	23	29.104	36.3	35.1	27.2	0.03	Id. : id. : clearer to S.
Nov. 13	2	29.042	37.0	36.2			Id. : rain.
	5	29.093	34.5	33.9			Id. : snow.
Nov. 14	20	29.308	24.5	39.1		Overcast : a few cir.-str. : breaking to SE.
	23	29.275	27.7	23.0	0.33	Hazy : cir.-str. : cumuli to E.
Nov. 15	2	29.261	30.4			Fair : a few cir.-str. : cum. to E.
	5	29.247	27.4			Id. : clear.
	20	29.282	23.9	30.9		Clear : cum. to S.
	23	31.3	30.6?	21.9	0.06	Id. : id.
Nov. 16	2	29.303	34.4	31.6			Fine : cirri : cum. on hor.
	5	29.325	29.4	29.3?			Clear.
	20	29.443	21.5	21.5	34.8		Clear : cirri : cum. to E.
	23	29.397	24.7	23.9	19.9	0.00	Id.
Nov. 17	2	29.430	30.9	29.9			Id.
	5	29.388	27.5	27.3			Id.
	20	29.261	17.7	17.5	32.3		Rather overcast : cumuli.
	23	29.255	23.1	22.5	14.6	0.00	Overcast.
Nov. 18	2	29.293	28.9	28.1			Id.
	5	29.314	28.7	28.3			Id. : breaking to E.
	20	29.281	30.4	30.2	30.4		Overcast.
	23	29.231	35.4	32.6	21.9	0.00	Cloudy : cumuli : open to S.
Nov. 19	2			Clear : cirri.
	5	29.124	32.3	31.3			Clear.
	20	29.078	22.5	22.5	36.2		Clear.
	23	29.036	26.7	26.5	21.9	0.00	Hazy : cum. : a few cir.-str.
Nov. 20	2	28.929	32.3	31.3			Overcast.
	5	28.834	36.3	34.1			Id. : light rain.
Nov. 21	20	28.670	38.3	37.9	38.6		Overcast : rain.
	23	28.737	37.7	36.8	35.6	0.92	Id. : clearing on N. hor.
Nov. 22	2	28.766	39.5	38.6			Id.
	5	28.829	38.6	37.6			Id.

76 DAILY METEOROLOGICAL OBSERVATIONS, NOVEMBER 22. 1841—JANUARY 17. 1842.

Göttingen Mean Time of Observation.		BARO- METER. Corrected.	THERMOMETERS.			RAIN GAUGE B.	STATE OF THE SKY.	
			Dry.	Wet.	Max. and Min.			
d.	h.	in.	°	°	°	in.		
Nov.	22	20	29.101	35.9	34.5	39.6		Fair: clear to E. : cum.
		23	29.151	38.6	37.2	34.1	0.00	Many cumuli : wind.
Nov.	23	2	29.198	39.9	37.9			Wild sky : cumuli : cirri.
		5	29.248	38.8	36.7			Cloudy : cumuli.
		20	29.381	37.0	35.9	41.6		Cloudy : cumuli.
		23	29.445	39.6	37.6	35.6	0.00	Overcast : cumuli : scud.
Nov.	24	2	29.396	41.8	38.9			Id. : id. : clear horizon.
		5	29.461	37.8	36.1			Lowering dark cumuli.
		20	29.549	29.0	42.6		Clear.
		23	29.603	33.1	31.6?	27.5	0.00	Id.
Nov.	25	2	29.609	39.3	36.8			Id.
		5	29.640	35.5	34.5			Id. : a few cumuli.
		20	29.677	29.4	39.8		Overcast.
		23	29.672	31.9	31.5	27.0	0.00	Fair : cumuli.
Nov.	26	2	29.635	35.2	32.2			Id. : cirri : black cum. on N. horizon.
		5	29.627	30.4	30.5			Clear.
		20	29.500	34.1	33.0			Overcast.
		23	29.494	35.5	33.7		0.04	Id.
Nov.	27	2	29.476	36.8	34.8			Id.
		5	29.455	36.7	35.3			Id.
Nov.	28	20	28.685	41.7	41.5	45.5		Overcast : rain.
		23	28.657	45.5	44.5	28.0	0.42	Id. : id.
Nov.	29	2	28.591	45.5	44.2			Clear : cir.-cum. : cum.
		5	28.564	46.0	45.0			Overcast.
		20	28.262	42.1	41.6	46.4		Overcast : rain.
		23	40.0	0.29	
Nov.	30	2	28.420	44.2	43.2			Overcast.
		5	28.524	44.6	43.4			Id.

1842.

Jan.	12	20	29.542	31.4	30.1	31.9		Overcast : wind.
		23	29.558	33.2	31.9	25.0	1.58	Id. : id.
Jan.	13	2	29.498	33.4	31.6			Id. : id.
		5	29.491	32.7	31.6			Id. : id.
		20	29.446	30.4	29.8	33.8		Light snow.
		23	29.446	31.3	30.7	30.0	0.00	Id.
Jan.	14	2	29.415	34.0	33.0			Id.
		5	29.339	33.7	33.1			Overcast.
		20	29.706	32.9	31.8	35.4		Overcast.
		23	29.748	35.1	33.6	30.0	0.15	Id.
Jan.	15	2	29.724	35.8	33.9			Id. : clear to W.
		5	29.700	34.5	33.2			Fine and clear.
Jan.	16	20	29.754	34.3	32.3	36.5		Clear : cumuli on E. horizon.
		23	29.860	33.3	31.1	30.6	0.20	Id.
Jan.	17	2	29.893	35.5	33.6			Id.
		5	29.966	34.2	32.4			Id.

Jan. 12^a 23^b. The rain registered is the quantity which has fallen since Nov. 30.

Göttingen Mean Time of Observation.		BARO- METER Corrected.	THERMOMETERS.			RAIN GAUGE B.	STATE OF THE SKY.	
			Dry.	Wet.	Max. and Min.			
d.	h.	in.	°	°	°	in.		
Jan.	17	20	30.102	28.4	27.8	38.1		Cloudy : cumuli.
		23	30.123	33.2	32.7	19.9	0.00	Scattered cumuli.
Jan.	18	2	30.122	37.5	36.2			Id.
		5	30.136	36.5	35.7			Overcast.
		20	30.125	37.5	36.8	38.9		Overcast : breaking to E.
		23	30.133	38.0	37.2	33.1	0.01	Id. : scud : light rain.
Jan.	19	2	30.046	42.0	40.4			Id. : gleams of sunshine.
		5	30.035	41.1	40.3			Id.
		20	29.907	37.3	35.6	43.6		Clear : light clouds : cir.-str.
		23	29.903	37.5	36.0	36.1	0.00	Clear : calm.
Jan.	20	2	29.868	41.1	38.7			Fine and clear : cir.-cum.
		5	29.842	38.2	36.4			Clear.
Jan.	21	20	29.396	30.9	32.4		Fair.
		23	29.359	31.2	23.5	0.00	Id. : cumuli.
Jan.	22	2	29.217	32.2			Overcast : snow.
		5	29.156	32.9			Id. : id.
Jan.	23	20	33.9		
		23	29.570	23.4	23.4	18.4	0.20	
Jan.	24	2	29.493	30.9	29.1			
		5	29.399	30.3	28.5			
		20	29.052	33.6	33.5	35.0		Overcast.
		23	29.171	34.6	33.5	22.2	0.02	Scattered cumuli : fair.
Jan.	25	2	29.279	36.9	34.5			Clear.
		5	29.352	32.0	30.9			Id. : clouds to W.
		20	29.042	35.4	33.5	37.5		Overcast : high wind.
		23	28.757	33.9	33.3	25.2	0.00	Id. : blowing a gale : sleet.
Jan.	26	2	28.554	36.5	34.5			Clouds broken : gale.
		5	28.509	35.3	34.5			Overcast : wind abated a little : rain.
		20	29.105	36.5	33.5	38.0		Overcast : wind.
		23	29.238	37.3	34.2	29.5	0.15	Clear.
Jan.	27	2	29.294	38.6	35.2			Id. : cirri.
		5	29.331	37.2	34.5			Id.
		20	29.467	34.6	33.0	39.1		Fair : hazy.
		23	29.529	36.8	34.5	31.8	0.00	Cirrous haze.
Jan.	28	2	29.546	38.0	35.6			Clear : a few cirri.
		5	29.577	36.6	34.3			Id.
		20	29.727	36.5	34.4	38.6		Overcast : cumuli.
		23	29.825	37.1	34.5	31.0	0.00	Cloudy : cumuli : clearing to N.
Jan.	29	2	29.888	38.4	35.3			Clear.
		5	29.925	35.2	33.0			Id.
Jan.	30	20	29.729	35.6	35.4	39.1		Overcast : rain.
		23	29.716	36.6	36.4	23.7	0.20	Id. : light rain.
Jan.	31	2	29.692	39.1	38.8			Id. : id.
		5	29.666	38.1	37.6			Id. : foggy.
		20	29.801	35.5	33.7	40.1		Clear.
		23	29.858	38.6	35.9	32.0	0.01	Id. : a little haze.
Feb.	1	2	29.843	40.7	38.2			Cloudy : cumuli.
		5	29.816	39.1	37.4			Id. : id.

Jan. 21^d, 22^d. The external thermometer case was being altered and painted, preventing the thermometers from being properly observed.

Göttingen Mean Time of Observation.		BARO- METER Corrected.	THERMOMETERS.			RAIN GAUGE B.	STATE OF THE SKY.
			Dry.	Wet.	Max. and Min.		
Feb. 1	d. h. 20	in. 29.677	° 43.4	° 41.3	° 44.3	in. 0.00	Overcast : cum. : clear on N. hor. Fair : scattered cum. : wild sky.
Feb. 2	23	29.774	43.6	40.5	34.0		Clear : cir.-cum. Cir.-cum. : hazy on hor.
Feb. 2	2	29.838	43.9	40.2			
	5	29.903	41.0	37.5			
	20	30.084	36.3	34.7	44.6		
	23	30.119	38.8	36.5	33.0	0.00	Cir.-cum. : cir.-str. on hor. Id. : cum.
Feb. 3	2	30.132	41.9	38.9			Clear : a few cirri. Id. : id.
	5	30.134	40.5	38.3			
	20	30.152	38.1	36.8	42.1		Overcast.
	23	30.157	40.0	39.2	32.5	0.00	Id.
Feb. 4	2	30.134	42.6	41.4			Clouds more broken : heavy cum. and scud. Scattered cumuli.
	5	30.128	42.8	40.5			
	20	30.109	30.7	30.6	44.8		Fine morning : foggy.
	23	30.092	33.2	31.8	27.8	0.00	Id. : id.
Feb. 5	2	30.044	40.5	37.5			Clear.
	5	30.006	38.6	36.4			Id.
Feb. 6	20	29.674	29.2	29.1	44.8		Overcast : breaking to E.
	23	29.668	28.5	28.5	22.1	0.00	Cir.-cum. Clear : a few cumuli.
Feb. 7	2	29.628	32.4	30.8			A good deal overcast : cumuli.
	5	29.609	33.4	31.6			
	20	29.636	32.7	32.5	37.2		Overcast.
	23	29.648	35.9	33.4	28.0	0.00	Id. : cum. : clear to W.
Feb. 8	2	29.627	39.6	36.8			Clear.
	5	29.633	37.5	35.5			Fair : cumuli over $\frac{1}{2}$ of the sky.
	20	29.534	32.7	32.4	39.3		Overcast : clouds rather broken : cum.
	23	29.512	34.8	34.4	29.2	0.00	Id. : breaking to E. Id. : light rain. Id. : id.
Feb. 9	2	29.458	37.8	36.8			
	5	29.417	39.5	38.5			
	20	29.444	42.5	41.5	42.6		Overcast : light rain.
	23	29.522	43.5	42.2	34.1	0.05	Id. : id. : wind.
Feb. 10	2	29.541	45.9	43.8			Heavy clouds : wind : patches of sky.
	5	29.541	44.5	42.6			Id. : id. : id.
	20	29.266	47.6	46.3	47.5		Overcast : rain : wind.
	23	29.341	48.6	47.0	40.7	0.05	Id. : wind. Id. : id.
Feb. 11	2	29.341	49.0	47.3			Clear : wind.
	5	29.422	45.6	43.6			
	20	29.465	49.0	48.3	50.0		Overcast : rain.
	23	29.384	45.7	44.6	38.2	0.30	Id. : id. : high wind. Id. : id. : id.
Feb. 12	2	29.317	47.1	45.6			Zenith clear : cir.-cum. : dense clouds all round the hor.
	5	29.314	47.1	44.1			
Feb. 13	20	29.941	34.5	33.5	37.4		Fine morning : cir.-cum. : cir.
	23	30.058	37.3	32.6	33.1	0.23	Id. : id.
Feb. 14	2	30.022	42.0	40.0			Overcast : wind.
	5	30.024	43.8	42.0			Id.
	20	29.911	44.5	42.3	45.0		Overcast : drops of rain : wind.
	23	29.901	45.2	43.7	37.1	0.00	Id. : light rain : wind.
Feb. 15	2	29.960	48.6	44.6			Zenith clear : cir.-cum. : heavy cum. on hor. : wind.
	5	30.044	43.3	39.3			Clear.

Göttingen Mean Time of Observation.		BARO- METER Corrected.	THERMOMETERS.			RAIN GAUGE B.	STATE OF THE SKY.
			Dry.	Wet.	Max. and Min.		
d.	h.	in.	°	°	°	in.	
Feb. 15	20	30.203	34.5	33.6	49.2		Dense cum on hor. : cir.-cum. : cir.-str.
	23	30.203	39.9	37.8	33.8	0.00	Clear : cir.-cum.
Feb. 16	2	30.168	46.6	42.5			Cum. : cir.-cum.
	5	30.141	43.5	40.7			Clear : cirri.
	20	30.024	41.4	38.8	48.0		Overcast : cum. : clearing to S.
	23	30.030	42.6	39.7	37.6	0.00	Id. : id. : cum.-str. : broken to S.
Feb. 17	2	30.001	45.4	42.7			Id. : cum.-str. : wind.
	5	29.979	44.3	41.1			Id. : id. : id.
	20	30.016	41.3	38.8	47.3		Overcast : cum. : cir.-str.
	23	30.046	42.5	39.7	36.1	0.00	Id. : cum.-str. : dense cum. to S.
Feb. 18	2	30.034	46.0	41.9			Clear : a few scattered cumuli.
	5	30.058	43.7	40.7			Clear from zenith to S. : dense clouds on N. hor.
	20	30.017	42.5	40.7	46.5		Overcast : dark cumuli.
	23	29.990	44.7	41.5	39.7	0.00	Detached cum. over $\frac{1}{2}$ of the sky.
Feb. 19	2	29.914	45.0	41.2			Much overcast : heavy dark cum. : wind.
	5	29.865	43.2	39.7			Clear.
Feb. 20	20	29.340	36.5	35.8	46.3		Overcast : rain.
	23	29.361	37.8	36.4	36.1	0.09	Id.
Feb. 21	2	29.385	41.7	37.8			Zenith clear : cum. on hor.
	5			
	20	29.449	34.0	33.4	41.7		Overcast : cumuli.
	23	29.431	37.0	34.8	29.9	0.01	Id. : id.
Feb. 22	2	29.357	41.5	36.5			Clear : cirri : wind.
	5	29.293	40.5	35.7			Id.
	20	29.124	38.6	37.0	43.1		Zenith clear : cumuli on hor.
	23	29.088	43.0	39.5	31.5	0.00	Clear : cir.-cum.
Feb. 23	2	28.991	45.7	40.6			Clear from zenith to S. : cum to N.
	5	28.941	40.0	38.4			Overcast : light rain.
	20	28.885	29.9	29.5	45.8		Dark cum. to E. : cir.-str. on W. hor. : mottled cum. and cirri.
	23	28.879	35.8	34.1	28.5	0.02	Hazy : cir.-cum.
Feb. 24	2	28.854	41.8	37.5			Clear.
	5	28.863	41.5	38.8			Overcast.
	20	28.971	34.6	33.1	43.8		Overcast.
	23	28.970	38.6	37.0	32.8	0.00	Id.
Feb. 25	2	28.956	40.5	39.0			Id.
	5	28.939	39.8	38.5			A good deal overcast : cumuli.
	20	28.856	34.7	32.8	42.1		Snow.
	23	28.894	34.5	33.8	32.2	0.01	Clearing : wind.
Feb. 26	2	28.958	39.4	35.8			Much overcast : cumuli.
	5	28.998	39.5	34.7			Clear : a few cumuli.
Feb. 27	20	28.824	37.7	35.0		Overcast : high wind : drops of rain.
	23	28.935	41.8	36.5	0.07	Clear : high wind : a few wisps of cloud.
Feb. 28	2	29.043	43.5	38.0			Open sky : a few cumuli.
	5			
Mar. 1	20		
	23	34.1	0.15	
Mar. 2	2	29.076	37.9	37.1			Overcast : light rain.
	5	29.107	37.0	36.3			Id. : id.

Feb. 27^d 23^h. Register thermometers omitted to be set on the 26th.

Göttingen Mean Time of Observation.		BARO- METER Corrected.	THERMOMETERS.			RAIN GAUGE B.	STATE OF THE SKY.
			Dry.	Wet.	Max. and Min.		
Mar. 2	20	29.467	36.3	36.0	39.1	0.39	Overcast : rain.
	23	29.484	38.8	38.4	34.4		Id. : id.
Mar. 3	2	29.418	40.1	39.7			Id. : id.
	5	29.299	42.1	41.7			Id. : id.
Mar. 4	20	29.495	37.0	35.0	42.1	0.54	Rather open sky : cum. and scud.
	23	29.518	41.3	37.6	34.9		Open sky : a few cumuli.
	5	29.523	43.0	38.5			Much overcast, with cumuli.
Mar. 5	20	29.506	43.7	38.6		0.00	Open sky : cum. on hor.
	23	29.612	38.0	36.5	44.8		Zenith clear : cir.-cum. : cum. on hor.
	5	29.658	43.5	41.3	34.5		Much overcast : cumuli.
Mar. 6	2	29.675	46.9	44.2			Id. : id.
	5	29.679	45.9	44.1			Overcast : wind.
Mar. 7	20	29.354	39.0	37.0	50.5	0.00	Much overcast.
	23	29.284	44.8	41.5	36.1		Id. : a few gleams of sunshine : wind.
Mar. 8	2	29.189	47.4	44.3			Id. : patches of sky : high wind.
	5	29.080	47.1	45.2			Overcast : wind and rain.
Mar. 9	20	29.014	37.5	36.0	50.1	0.07	Overcast : rain.
	23	29.035	42.5	39.5	37.1		Fair : many cumuli.
	5	29.081	44.6	40.0			Zenith clear : cum. on hor. : dense black clouds to NW.
Mar. 10	20	29.077		0.01	Storm of rain to NE. : dense nimbi to S. : open sky to W. : cum.
	23	29.121	32.9	32.1	46.4		Fine and clear.
	5	29.116	36.8	35.7	30.0		Rather open sky : cirri seen above the cum. [eastward.
Mar. 11	2	29.094	36.5	34.1			Clear with cirri from zenith to W. : storm of rain passing off to
	5	29.091	40.9	37.0			Heavy cum. to N. : clear to S.
Mar. 12	20	29.166	35.4	32.8	41.8	0.01	Open sky : a few cirri from zenith to W. hor. : cum. on E. hor.
	23	29.260	37.2	33.2	31.0		Clear with cirri : cum. low on hor.
	5	29.366	40.4	36.5			Id. : id.
Mar. 13	20	29.485	40.2	36.0		0.00	Clear : a few cum. and cir.-str.
	23	29.539	38.2	36.5	46.5		Overcast : cir.-str. on NE. hor.
	5	29.428	42.7	41.0	33.1		Id. : drops of rain.
Mar. 14	2	29.219	48.8	46.8			Id. : light rain : wind.
	5	29.206	43.7	40.8			Id. : high wind : clear from zenith to westward.
Mar. 15	20	29.626	39.8	37.5	52.3	0.02	Sky covered with cir.-cum. and cir.-str.
	23	29.668	44.5	40.5	36.4		Overcast : a few cir.-str. on hor. : cir.-cum. : clearing to S.
	5	29.669	47.4	43.0			Overcast : haze.
Mar. 16	2	29.584	44.0	40.0			Id. : cumuli.
	5	29.861	41.5	40.0	48.9		Overcast.
Mar. 17	20	29.867	45.8	43.5	33.5	0.01	Id. : clearing a little to S.
	23	29.874	48.3	46.4			Id. : strong breeze.
Mar. 18	2	29.879	48.9	47.4		0.00	Id. : quite calm.
	5	29.950	48.6	47.5	51.9		Overcast : cir.-str. on hor. : clearing in zenith.
	20	29.974	50.9	48.5	45.3		Id. : a few breaks : cir.-cum. : strong breeze.
Mar. 19	2	29.946	51.9	49.5			Clearing a little : gleams of sunshine.
	5	29.957	50.1	48.1			Overcast : cumuli.
Mar. 20	20	29.982	46.6	45.7	53.5	0.00	Overcast.
	23	29.973	48.6	47.1	46.1		Id. : quite calm.
	5	29.928	50.1	48.1			Id. : cumuli.
Mar. 21	5	29.868	49.1	47.1			Id.

Göttingen Mean Time of Observation.		BARO- METER Corrected.	THERMOMETERS.			RAIN GAUGE B.	STATE OF THE SKY.
			Dry.	Wet.	Max. and Min.		
d. h.	in.	°	°	°	in.		
Mar. 16	20	29.788	40.5	38.5	52.3		Open sky : cum.
	23	29.761	44.2	41.5	36.4	0.06	Id. : id. : cir. : strong breeze.
Mar. 17	2	29.672	46.4	43.0			Overcast : cumuli.
	5	29.511	45.3	42.5			Id. : dark cumuli : wind. [bright sunshine.
	20	29.160	40.7	38.5	47.5		Open sky from zen. to E. : dense black clouds from zen. to W. :
	23	29.178	44.0	39.7	37.2	0.07	Cloudy : cumuli : strong breeze.
Mar. 18	2	29.137	44.5	39.8			Id. : id.
	5	29.101	41.7	38.5			Rather open : cumuli.
	20	29.012	35.5	33.8	45.5		Overcast : gusts of wind.
	23	28.975	39.1	36.4	33.6	0.00	Much overcast : opening to westward : wind.
Mar. 19	2	28.951	42.8	40.0			Many cumuli : cum.-str. on E. hor.
	5	28.898	44.8	41.0			Id.
Mar. 20	20	29.884	36.4	33.8	46.0		Overcast : cumuli : opening to W.
	23	29.956	39.8	36.5	30.3	0.20	Open sky : cum. : cir.-str.
Mar. 21	2	30.023	40.5	36.7			Overcast : cumuli : high wind.
	5	30.070	39.2	34.6			Id. : id. : id.
	20	29.922	35.5	33.9	41.6		Overcast : calm.
	23	29.863	36.0	35.5	29.3	0.11	Id.
Mar. 22	2	29.864	40.5	38.6			Id. : wind.
	5	29.909	40.2	36.0			Clear : high wind : cumuli.
	20	30.097	34.3	32.6	41.8		Zenith clear : cirrous haze. : dark cum. on E. hor.
	23	30.113	36.7	33.6	34.0	0.07	Clear.
Mar. 23	2	30.104	40.7	35.8			Much overcast : a few openings : cum.-str.
	5	30.072	41.5	36.5			Open sky.
	20	30.017	44.7	42.8	42.1		Cloudy : partial blue sky.
	23	30.017	50.1	46.1	34.0	0.00	Overcast : cum. : cir.-str. [patches of sky.
Mar. 24	2	30.004	53.7	49.5			Much overcast : gleams of sunshine : cum. : cum.-str. to N. :
	5	29.957	54.4	48.8			Cloudy : clearing in zenith.
	20	29.719	41.5	39.5	55.9		Much overcast : strong breeze : clear in zenith.
	23	29.623	47.6	42.5	31.0	0.00	Id. : cumuli.
Mar. 25	2	29.482	49.6	45.6			Id. : id.
	5	29.269	43.4	42.7			Overcast : rain : wind.
	20	29.059	37.5	34.5	50.6		Open sky : cirro-cumuli.
	23	29.108	41.0	35.5	33.0	0.08	Much overcast : high wind. : cum.
Mar. 26	2	29.145	42.0	36.5			Id. : id.
	5	29.181	41.0	35.5			Id. : id. : drops of hail.
Mar. 27	20	29.228	44.9	44.3	50.1		Quite overcast : light rain.
	23	29.233	50.5	48.8	31.0	0.07	Open to E. : a few cum. : overcast from zenith to W.
Mar. 28	2	29.217	51.7	49.1			Overcast chiefly with dark cum. : about $\frac{1}{6}$ of sky to E.
	5	29.160	51.0	49.4			Almost clear : a few cum. : wind.
	20	29.459	42.4	39.0	52.9		Clear.
	23	29.499	45.4	41.4	37.1	0.00	Much overcast : cumuli : wind.
Mar. 29	2	29.534	48.1	42.5			Id. : id. : id.
	5	29.542	46.4	41.7			Open sky : cumuli.
	20	29.400	41.3	39.0	49.3		Overcast : light rain.
	23	29.350	41.8	43.5	37.6	0.04	Id. : id.
Mar. 30	2	29.331	47.1	45.0			Id. : rain : wind.
	5	29.339	49.3	44.6			Clear : a few cumuli : wind.

Göttingen Mean Time of Observation.		BARO- METER Corrected.	THERMOMETERS.			RAIN GAUGE B.	STATE OF THE SKY.
			Dry.	Wet.	Max. and Min.		
d.	h.	in.	°	°	°	in.	
Mar. 30	20	29.126	42.5	41.5	54.8?		Overcast : light rain.
	23	29.034	50.6	48.5	37.2	0.02	Id. : wind and rain.
Mar. 31	2	29.046	47.9	42.7			Open sky : cirri : high wind.
	5	29.109	46.1	41.2			Clear : cirri.
	20	29.002	38.1	36.5	48.5		Overcast to SW. : clear to NE.
	23	29.027	43.7	39.7	32.7	0.01	Open sky : cumuli.
Apr. 1	2	29.072	44.8	39.5			Clear from zen. to S. : heavy clouds to N.
	5	29.132	40.7	38.5			Overcast : clearing to northward : rain.
	20	29.523	37.5	33.4	47.2		A good deal overcast : clearing to N. (windward.)
	23	29.591	39.7	35.0	35.4	0.03	Overcast : high wind.
Apr. 2	2	29.630	37.5	34.5			Storm of hail : high wind.
	5	29.647	41.3	36.3			Open sky : very wild.
Apr. 3	20	30.102	38.1	36.1	47.0		Clear : cir.-cum. : cir.-str.
	23	30.118	43.3	38.8	28.8	0.00	Clear : cum. : cir.-str.
Apr. 4	2	30.096	48.2	40.8			Cir.-str. : a few cumuli.
	5	30.083	50.7	42.4			Clear : cir.-str.
	20	30.085	41.8	39.3	50.5		Fine and clear : a few cir.-str.
	23	30.090	49.6	43.5	31.5	0.00	Clear.
Apr. 5	2	30.066	54.6	46.9			Id.
	5	30.032	54.5	46.6			Id.
	20	30.029	36.0	34.5	55.4		Clear.
	23	30.015	48.1	43.5	29.0	0.00	Id.
Apr. 6	2	29.961	53.6	47.5			Id.
	5	29.915	52.1	45.6			Id.
	20	29.844	42.3	42.0	54.9		Overcast : light rain.
	23	29.834	43.7	43.1	39.2	0.00	Id.
Apr. 7	2	29.821	45.9	44.5			Id.
	5	29.764	41.8	40.5			Id.
	20	29.983	36.9	36.0	47.8		Clear.
	23	29.982	49.1	44.6	33.1	0.00	Id.
Apr. 8	3	29.952	52.6	45.6			Id.
	5	29.945	53.6	47.6			Id.
	20	30.145	33.6	33.1	54.8		Clear.
	23	30.149	46.6	42.5	27.2	0.00	Id.
Apr. 9	2	30.141	53.0	46.4			Id.
	5	30.112	53.6	47.2			Id.
Apr. 10	20	30.129	35.6	35.6	57.1		Clear.
	23	30.134	46.4	41.3	29.0	0.01	Id.
Apr. 11	2	30.128	46.9	41.4			Cum.-str.
	5	30.120	45.9	40.8			Cumuli.
	20	30.137	38.4	37.4	48.2		Fair : many cumuli.
	23	30.111	43.7	38.7	27.8	0.00	Cloudy : cumuli.
Apr. 12	2	30.091	45.6	39.7			Cumuli : cir.-cum.
	5	30.051	44.6	38.5			Clear : a few cumuli.
	20	30.018	40.5	35.6	47.0		Overcast : cumuli.
	23	30.023	42.5	37.5	34.0	0.00	Id. : id.
Apr. 13	2	30.029	43.8	38.3			Open sky : cumuli.
	5	30.012	43.4	37.8			Id. : id.

March 30^a 22^b. Index of maximum thermometer suspected to have been shaken along the tube by the wind.

Göttingen Mean Time of Observation.		BARO- METER Corrected.	THERMOMETERS.			RAIN GAUGE B.	STATE OF THE SKY.
			Dry.	Wet.	Max. and Min.		
d.	h.	in.	°	°	°	in.	
Apr. 13	20	30.038	39.8	36.8	45.3		A good deal overcast : cum. : strong breeze.
	23	30.021	43.3	39.2	36.6	0.00	Id. : id.
Apr. 14	2	29.998	44.9	41.0			Id. : id. : high wind.
	5	30.004	45.2	42.0			Id. : id. : id.
	20	30.076	42.5	39.5	46.8		Overcast : strong breeze.
	23	30.093	43.5	41.2	40.7	0.01	Id. : high wind.
Apr. 15	2	30.096	44.9	40.8			Id. : id. : clouds breaking.
	5	30.094	43.5	40.2			Id. : a few openings.
	20	30.137	42.2	39.5	46.2		Overcast : calm.
	23	30.154	45.1	41.3	39.2	0.00	Id. : id.
Apr. 16	2	30.134	48.1	43.4			Open sky : cumuli.
	5	30.100	49.6	43.8			Clear.
Apr. 17	20	30.009	35.5	35.4	52.5		Misty.
	23	29.984	51.6	47.4	30.0	0.00	Clear.
Apr. 18	2	29.957	60.6	51.9			Id. : cir.-cum.
	5	29.938	61.6	53.9			Id. : cum.
	20	30.000	45.8	43.5	62.7		Clear : cir.-cum. : cir.-str.
	23	29.996	53.6	48.6	37.6	0.00	Id. : id. : id.
Apr. 19	2	29.956	60.4	52.4			Id. : id. : id. : a few cum.
	5	29.931	61.3	53.3			Id. : id.
	20	29.997	48.6	46.6	63.2		Clear.
	23	29.984	57.1	50.9	36.1	0.00	Id.
Apr. 20	2	29.959	63.2	53.3			Id.
	5	29.937	63.1	53.9			Id.
	20	29.971	43.5	41.7	65.4		Clear in zenith : hazy on hor.
	23	29.964	56.8	49.1	33.9	0.00	Clear : almost no wind.
Apr. 21	2	29.924	65.5	51.9			Cir.-str. over $\frac{1}{4}$ of sky, chiefly to W.
	5	29.890	66.5	55.8			Sky covered with diffuse cirri.
	20	29.883	45.6	43.0	66.8		Clear.
	23	29.849	60.2	50.8	36.1	0.00	Id.
Apr. 22	2	29.814	67.3	52.5			Id. : a few cir.-str.
	5	29.783	65.0	50.8			Cir.-str. : reticulated cirri.
	20	29.810	41.8	41.3	65.8		Overcast : foggy.
	23	29.812	47.3	45.3	37.3	0.00	Clear : cirri : a few cumuli.
Apr. 23	2	29.761	61.8	55.6			Id. : id.
	5	29.735	61.0	51.6			Id. : id.
Apr. 24	20	29.912	64.4		Overcast.
	23	29.933	49.5	47.8	40.2	0.00	Haze just cleared off : a few cum. to W.
Apr. 25	2	29.922	64.9	54.7			Clear : a few cumuli.
	5	29.929	62.5	53.5			Clear and calm : a few light cum. to S.
	20	30.003	40.5	39.8	63.4		Fog.
	23	29.989	55.7	50.4	31.2	0.00	A patch of mottled cirri to N.
Apr. 26	2	29.974	62.8	54.8			Clear.
	5	29.959	60.8	54.8			Id.

April 15^d 20^h. Observation made at 20^h 20^m.

April 25^d. The previous observations were made by Mr. Russell.

Göttingen Mean Time of Observation.	BAROMETER Corrected.		THERMOMETERS.		RAIN GAUGE B.	WIND.		Clouds moving from	Quantity of Clouds.	STATE OF THE SKY. Species of Clouds, &c.
	h. m.	in.	Wet.	Max. and Min.		Estimated force.	Direction.			
Apr. 26	20	0	41.8	60.9	0.0				0-10.	Clear: calm.
	23	0	29.965	28.3	0.00					Id.
Apr. 27	2	0	58.3	54.8						Id.
	5	0	29.901	52.7						Id.
Apr. 28	20	0	29.927	36.3	60.9				10.0	Overcast.
	23	0	29.931	45.8	28.2		NE.		0.5	Cir.-str. to N. and NE.
Apr. 29	2	0	29.896	58.3	51.9		NE.		0.3	Cir. and cir.-str. to N. and SE.
	5	0	29.869	60.8	58.1		NE.		0.5	A low line of cir.-str. to NE.
Apr. 30	20	0	29.908	47.5	60.7				0.3	Cir.-str. to SW.
	23	0	29.893	58.1	55.7				0.0	Clear.
May 1	2	0	29.862	61.8	61.9		SE.		0.3	Cir.-str. to SW. and W.
	5	0	29.839	62.3	60.8		SE by E.		0.8	Cir. and cir.-str. to SW. and W.: a small patch to NW.
May 2	20	0	29.842	39.3	38.6				10.0	Overcast.
	23	0	29.837	47.8	45.8		NE.		9.0	Cumuli.
May 3	2	0	29.819	49.2	48.1		NE.		0.8	Cum. on hor. from SE. round by N. to NW.
	5	0	29.796	50.7	49.5		NE.		0.3	A small patch of cir.-str. to NE.
May 4	20	0	30.010	43.9	43.1				10.0	Clouds breaking.
	23	0	29.979	49.5	47.9				0.2	Sky milky: cirro-strati to S.
May 5	2	0	29.915	63.9	60.8		SE.		3.0	Scattered cumuli.
	5	0	29.891	61.8	59.2		SE by E.		2.5	Cumuli chiefly to W. and NW.
May 6	20	0	29.779	40.8	39.7				0.1	Sky milky to E.: streaks of cirri.
	23	30	29.706	54.4	52.9		E.		1.0	Detached cum.: bands of cirro-cum.
May 7	2	0	29.649	60.3	58.0		SE.	SE.	5.0	Cum. with cir. tails: cir.-cum.: hazy to SE.
	5	0	29.602	59.0	57.0		NNE.		9.0	Electric-looking cumuli: sky milky.
May 8	20	0	29.611	47.5	46.5		NW.	NW.	10.0	Heavy black cumuli.
	23	0	29.611	51.4	50.0		NW.		9.8	Sky to NW.
May 9	2	0	29.593	56.1	53.8		NW.		6.0	Heavy detached cumuli.
	5	0	29.571	56.0		NW.		3.0	Cumuli round hor.: a few cir.-str.

April 27^a. The scale used in the estimation of the quantity of clouds is 0 to 10; 0 indicating no clouds, 10 no sky. The estimations were made in units and quarters, although given here in decimals. 9.9 signifies small patch or patches of sky; 0.1 small patch or patches of clouds.

The scale used in the estimations of the force of the wind was 0 to 6; it was found, however, on comparison with the Anemometer erected Oct. 21, that estimations under 1.5 were nearly equivalent to the same quantities by the Anemometer, that is, pounds of pressure on the square foot of surface; for estimations beyond 1.5 the value is more, increasing to nearly double the value at 3.0.

The direction of the wind is estimated with the aid of a handkerchief.

May 24 and 23^a. Perpendicularity of the barometer verified, which was done at intervals afterwards, but no adjustment required.

May 1^a. The readings of the rain gauge B. were lost during the month of May, the sum for the month, however, was preserved.

May 3^a. The motion of the clouds are determined by reference to the walls of the Observatory, which are in the meridian and prime vertical.

May 4^a 5^h. No readings of the wet bulb thermometer are given till May 18^a, as it was then discovered that the silk round the bulb had lost its power of capillary attraction to such an extent as to render the mass of the readings from May 4^a valueless; probably this even affects the observations for some days previous to May 4. It seems likely that Mr. Russell had not changed the silk for some time.

Göttingen Mean Time of Observation.	BARO- METER Corrected.		THERMOMETERS.			RAIN GAUGE B.	WIND.		Clouds moving from	Quan- tity of Clouds.	Species of Clouds, &c.
	d.	h.	m.	in.	Dry.		Wet.	Max. and Min.			
May 4	20	0	0	29.488	46.4	62.3	0.6	SSW.	0-10.	Rain, slight drizzle.
May 5	23	0	0	29.415	50.5	39.3	0.8	SSW.	10.0	Cumuli : breaking to SE.
May 6	2	0	0	29.304	52.8	1.8	SSW.	10.0	Scud.
May 7	5	0	0	29.209	52.5	0.8	SSW.	10.0	Scud.
May 8	20	0	0	28.892	49.8	57.2	0.5	S by E.?	9.9	Scud : sky to SE by E.
May 9	23	0	0	28.869	51.8	43.6	1.0	SSW.	9.0	Cumuli : nimbi : heavy shower.
May 10	2	0	0	28.840	54.8	1.0	SSW.	7.0	Detached cumuli : nimbi ?
May 11	5	0	0	28.827	52.8	1.0	SSW.	9.8	Black cumuli and scud.
May 12	20	0	0	28.772	49.2	57.7	0.5	SW.	10.0	Cumuli : scud.
May 13	23	0	0	28.632	47.8	43.9	0.3	SSW.	10.0	Heavy rain.
May 14	2	0	0	28.550	47.9	1.0	SSW.	10.0	Id.
May 15	5	0	0	28.539	49.9	0.5?	SW.	10.0	Id.
May 16	8	20	0	29.542	44.7	57.4	NW : 0	9.0	Cumuli : scud : linear cirri above.
May 17	23	0	0	29.641	49.3	36.6	0.5	NW.	9.8	Id. : id.
May 18	2	0	0	29.703	52.9	0.5	9.0	Id. : id.
May 19	5	0	0	29.749	52.7	40.4	6.0	Id.
May 20	20	0	0	29.907	45.6	55.4	0.3	W.	0.3	Linear cirri to E.
May 21	23	0	0	29.889	53.0	33.1	0.3	NW.?	2.0	Detached cumuli to SE.
May 22	2	0	0	29.864	58.1	0.3	6.0	Id.
May 23	5	0	0	29.804	59.0	0.3	SW.	8.0	Cumuli.
May 24	20	0	0	29.694	50.7	62.2	0.5	SSE.?	8.0	Patches of scud : diffuse cirri : cirro-str.
May 25	23	0	0	29.657	51.0	46.3	0.8	SE by S.	6.0	Cumuli 4 : cirro-cum. 2 : cirri 1.
May 26	2	0	0	29.621	58.2	1.0	SE by S.	8.0?	Electric-like cum. : cirro-cum. : linear cirri.
May 27	5	0	0	29.615	51.9	10.0	Heavy shower of rain.
May 28	20	0	0	29.731	43.8	60.0	0.0	10.0	Smart shower.
May 29	23	0	0	29.754	44.2	42.8	0.0	10.0	Light rain : rain since 20h.
May 30	2	0	0	29.765	50.8	0.0	SW : 0.	9.0	Heavy cumuli : diffuse cirri.
May 31	5	3	0	29.761	53.4	4.0	Cumuli.
May 1	20	0	0	29.821	47.6	56.1	0.0	0.	8.0	Cirro-cumuli.
May 2	23	0	0	29.809	55.0	38.9	0.0	SE.	7.0	One or two cum. : diffuse cir.-cum. : haze and linear cirri.
May 3	2	0	0	29.797	62.6	0.0	S.	9.8	Cumuli : irregular cir.-cum. : very hazy.
May 4	5	0	0	29.795	58.1	0.0	10.0	Like buttermilk : a few cumuli.
May 5	20	0	0	29.941	52.1	66.9	0.0	4.0	Flaky cir.-cum. : haze : cirri.
May 6	23	0	0	29.962	59.1	43.3	0.1	1.0	Cum. round hor. : dense haze to E. : sky milky.
May 7	2	0	0	10.0	Cirrous haze.
May 8	5	0	0	29.959	63.9	65.6

May 7^d 7^h. The barometer began to rise, so that 5^h is probably the minimum.
 May 8^d 20^h. The maximum temperature registered is that of Sunday, and the minimum that of this morning; previously the maxima and minima registered on the Monday mornings may be either those of Saturday or Sunday; for the future, the maximum and minimum read on Sunday are placed opposite 5^h of the Saturday, and those read on Monday morning are placed opposite 20^h of that morning.

Göttingen Mean Time of Observation.		BARO- METER Corrected.		THERMOMETERS.			RAIN GAUGE B.	WIND.		STATE OF THE SKY.		
				Dry.	Wet.	Max. and Min.		Esti- mated force.	Direction.	Clouds moving from	Quan- tity of Clouds.	Species of Clouds, &c.
May 15	20 0	in. 30.276	° 50.9	°	° 65.0	in.	0-6.			0-10. 0.3		Sky rather milky.
May 16	2 0	30.262	60.0	40.5	0.3	SE by S.		0.3		Cum. on NNW. hor.; patches of cirri.
	2 0	30.223	65.0	0.3	SE by S.		0.5		Cum. to NW, W, S, and SE., hor.
	5 0	30.198	64.3	0.3	SE by S.		0.3		Cumuli to S. horizon.
May 17	20 0	30.202	48.0	66.1	0.0			10.0		Cumuli rapidly disappearing.
	23 0	30.175	50.6	45.9	0.3	NE.		4.0		Detached cumuli on hor.; cirri.
	2 0	30.129	56.7	0.5	NE.		1.5		Cirri to S.
	5 0	30.084	56.7	0.3	NE.		0.5		
May 18	20 0	29.931	44.6	57.2			10.0		Cumuli: cirro-cum.; sky hazy.
	23 0	29.878	51.2	43.0	0.0			7.0		Cumuli: cir-cum.; linear cirri.
May 19	2 0	29.810	59.7	54.5			2.0		Cumuli on hor.; patches of cir-cum.
	5 0	29.739	59.4	53.9	0.5	NE.		2.0		
May 20	20 0	29.610	47.2	45.7	61.1	0.0			10.0		Scud.
	23 0	29.579	49.9	47.1	43.5	0.0			10.0		Id.
	2 0	29.546	50.1	46.6	0.5	ESE.		10.0		Id.
	5 0	29.520	49.3	46.6	0.0			10.0		Id.
May 21	20 0	29.340	50.8	48.4	55.4			4.0		Cumuli: cirri.
	23 0	29.307	57.3	50.5	46.3	0.5	S.	SSW: 0.	6.0		Cumuli: cirri.
	2 0	29.278	59.2	52.0	0.8	S.		9.0		Heavy cum.: like thunder to S. and E.
	5 0	29.240	53.9	49.3	1.0			10.0		Cumuli: nimbi: rain to S and E.
May 22	20 0	29.367	48.8	45.6	61.1			8.0		Few cumuli: cirro-cumuli.
	23 0	29.377	51.9	46.7	39.5	0.5		SSW.	9.9		Cumuli: scud.
May 23	2 0	29.379	54.2	49.0		SW.	10.0		Cumuli: scud.
	5 0	29.343	54.9	49.8	59.8	0.3			10.0		Id.: id.
May 24	20 0	29.535	50.0	48.6	63.9			10.0		Smart shower commenced.
	23 0	29.555	47.8	47.8	44.7			10.0		Heavy rain began at 22 ^h 40 ^m .
May 25	2 0	29.530	61.8	52.9	0.8	SE.		4.0		Cumuli.
	5 0	29.532	62.9	52.8	0.8	SE.		2.0		Id.
May 26	20 0	29.696	51.8	48.6	62.9	0.3			4.0		Few cumuli: cirri.
	23 0	29.706	59.7	51.9	39.0	0.8		S.	4.0		Cumuli: scud; haze.
May 27	2 0	29.725	54.0	50.2	0.0			10.0		
	5 0	29.706	53.3	50.4	0.0			10.0		Cumuli: cirro-strati.
May 28	20 0	29.505	50.1	49.7	61.7			10.0		Scud?
	23 0	29.539	55.8	52.0	46.5	0.3			9.9		Cumuli: scud.
May 29	2 0	29.552	60.7	54.3	0.3		SW: 0.	9.0		Cumuli-cirri: like thunder.
	5 0	29.580	53.7	52.0			10.0		Cumuli, nimbi, &c.: thunder storm.

Göttingen Mean Time of Observation.		BARO- METER Corrected.		THERMOMETERS.			RAIN GAUGE B.	WIND.		STATE OF THE SKY.	
				Dry.	Wet.	Max. and Min.		Esti- mated force.	Direction.	Clouds moving from	Quan- tity of Clouds.
May 25	0	in.	51.4	65.4	in.	0-6					
May 25	20	29.611	52.0	51.4	65.4	...					Dense mist.
May 25	23	29.586	59.7	53.0	42.0	0.2	SE.		SE.	10.0	Heavy black cum. : still like thunder.
May 26	0	29.573	57.8	52.1		0.5	SE by E.		SE.	6.0	Cumuli.
May 26	5	29.576	52.9	49.7		...			SE.	9.0	Black cumuli : sky to NW.
May 27	0	29.573	50.4	49.4	61.7	0.0				10.0	Foggy.
May 27	23	29.587	57.2	53.6	43.0	0.3	SW.		SW.	9.9	Black cumuli : sky to NE.
May 27	2	29.604	61.0	54.2		...				9.0	Cumuli in fine ranges.
May 27	5	29.612	62.1	53.3		...			SW : 0.	5.0	Id. : cirri.
May 28	0	29.682	52.1	49.1	64.8?	0.5				10.0	Scud.
May 28	23	29.703	58.3	51.7	46.4	0.5	W.			6.0	Id.
May 28	2	29.700	58.5	51.2		0.8	W.			9.0	Id.
May 28	5	29.719	59.8	51.0	64.8	0.5				2.0	Id.
May 29	0	29.517	54.3	50.1	63.4	0.6	SW?		SW.	6.0	Scud : cir.-str. : cir.-cum.
May 29	23	29.530	57.0	52.1	48.5	0.8			SW.	7.0	Id. : id.
May 30	0	29.582	56.6	50.7		1.0	W?			9.0	Id. : showers around.
May 30	5	29.602	57.4	50.0		0.5				8.0	Cumuli : id.
May 31	0	29.804	52.9	47.8	62.7	0.8	SW.			3.0	Cumuli.
May 31	23	29.825	57.0	49.8	45.1	0.6	SW.		SW : 0.	4.0	Id.
May 31	2	29.827	60.9	51.3		0.5			SW.	7.0	Id. : cirri.
May 31	5	29.844	60.2	51.3		...				8.5	Scud.
June 1	0	29.874	53.9	49.5	64.4	0.3				9.0	Cirri : cirro-strati,—breaking.
June 1	23	29.830	57.7	50.6	41.7	...				10.0	Cumuli : cirri.
June 1	2	29.763	55.7	52.3		0.3				10.0	Id.
June 1	5	29.683	56.9	55.0		0.8				10.0	Id. : nimbi ? passing shower.
June 2	0	29.944	50.9	45.9	61.3	...			SE.	0.3	Cumuli : cirri.
June 2	23	29.994	56.1	47.4	45.0	0.3			W.	3.0	Id. : id.
June 2	2	30.009	59.0	49.8		0.3				5.0	Id. : id.
June 2	5	30.015	62.2	51.9		...				3.0	Id. : id.
June 3	0	30.055	51.5	47.9	65.8	0.0				0.0	Cumuli : cir.-str. : cir. : cir.-cum.
June 3	23	30.018	63.0	55.9	36.4	0.3	W.			4.0	Cumuli.
June 3	2	29.974	68.3	59.8		0.3				7.0	Cumuli : diffuse cirri.
June 3	5	29.938	68.0	59.9		0.3				8.0	Cumuli : cirro-cum.
June 4	0	29.861	61.0	56.6	72.6	0.0				1.5	Cirri from cirrous nests.
June 4	23	29.815	67.2	59.3	44.8	0.0				5.0	Cumuli : cirri : cirro-cum.
June 4	2	29.783	69.7	58.1		...				7.0	Cum. : cir.-cum. : cir.-str. : cir. : cir. haze.
June 4	5	29.765	65.9	58.5	73.0	0.0				10.0	Cirro-strati : cirrous haze.
June 4	5	29.765	65.9	58.5	52.4	0.0					

May 27^d. A new piece of silk put on the wet bulb thermometer; the bulb was always wetted previous to reading since May 18^d. The silk was not changed till it was attempted to discover, by readings before and after wetting the bulb, to what extent the observations before May 18^d were valueless.

Göttingen Mean Time of Observation.	BAROMETER Corrected.	THERMOMETERS.			RAIN GAUGE B.	WIND.		Clouds moving from	Quantity of Clouds.	STATE OF THE SKY.
		Dry.	Wet.	Max. and Min.		Estimated force.	Direction.			
June 5 20 0	in. 29.805	54.4	51.5	69.9?	in. 0.0	0-6		0-10	0-10	Breaking to E.
June 5 23 0	29.831	61.8	56.0	50.8	0.02	0.0	S.	7.0	10.0	Scud.
June 6 2 0	29.846	65.1	57.9		0.5	0.5		
June 6 5 0	29.866	65.2	57.0		0.5	0.5		1.5	1.5	Cumuli to S.
June 7 2 0	30.019	49.4	48.6	66.9	0.00	0.0		10.0	10.0	Thick fog.
June 7 5 0	30.022	59.0	55.5	44.4	0.00	0.3		8.0	8.0	Few cumuli : cirri.
June 8 2 0	30.020	61.1	61.1		ESE.	3.0	3.0	Id. : cirrous haze.
June 8 5 0	30.029	72.4	62.8		0.5	0.5		4.0	4.0	Id. : id.
June 9 2 0	30.167	58.8	54.4	74.0	0.00	0.0	E by N.	0.3	0.3	Cirri.
June 9 5 0	30.166	67.8	56.9	44.0	0.00	0.0		1.0	1.0	Cirro-cumuli : cirri.
June 10 2 0	30.154	70.8	59.1			0.3	0.3	Cumuli : cirri.
June 10 5 0	30.139	69.5	58.6		0.8	0.8		0.0	0.0	Gusty.
June 11 2 0	30.171	50.3	49.8	71.2	0.00	0.0		10.0	10.0	Heavy mist.
June 11 5 0	30.171	59.2	55.1	40.5	0.00	0.3		0.3	0.3	Cirri.
June 12 2 0	30.140	65.2	56.8		0.00	0.8	NE.	0.1	0.1	Cirri.
June 12 5 0	30.117	64.5	56.9		0.6	0.6	NE.	0.0	0.0	Sky brownish, then milky above hor.
June 13 2 0	30.079	57.2	51.9	65.9	0.00	0.0	NE.	1.0	1.0	Cirri.
June 13 5 0	30.060	59.7	54.9	40.6	0.00	0.5	NE.	2.0	2.0	Cumuli : cirri.
June 14 2 0	30.050	60.8	56.0		0.00	0.5	NE.	1.0	1.0	Scud.
June 14 5 0	30.033	57.0	53.4		0.3	0.3	NE by N.	10.0	10.0	Id.
June 15 2 0	30.106	53.0	50.7	61.9	0.00	0.0		10.0	10.0	Scud.
June 15 5 0	30.107	60.3	56.0	50.1	0.00	0.0		9.8	9.8	Indefinable mass.
June 16 2 0	30.090	65.6	58.9		0.00	0.0	NE by E.	0.0	0.0	
June 16 5 0	30.086	64.9	58.5	68.6	0.3	0.3		0.0	0.0	Vapoury cumuli.
June 17 2 0	30.108	55.0	52.9	67.1	0.00	0.0		2.0	2.0	
June 17 5 0	30.056	67.2	62.0	42.2	0.00	0.0		0.0	0.0	
June 18 2 0	29.997	75.2	62.8		0.00	0.0		1.0	1.0	Cumuli : cirro-strati.
June 18 5 0	29.938	77.6	61.7		0.00	0.0		1.8	1.8	Id. : id.
June 19 2 0	29.921	54.9	53.0	80.8	0.00	0.0		10.0	10.0	Light fog.
June 19 5 0	29.905	63.6	58.2	49.3	0.00	0.3	ESE.	7.0	7.0	Cum. : cir.-cum. : cir.-str.
June 20 2 0	29.845	70.2	62.9		0.00	0.3	NNW.	4.0	4.0	Cum. : cir.-str. : like thunder.
June 20 5 0	29.817	68.4	58.9		0.5	0.5	NNW.	9.0	9.0	Cumuli : sky in patches.
June 21 2 0	29.866	53.3	47.6	73.9	0.00	0.0	NNW.	8.5	8.5	Cumuli : cirri : sky to N.
June 21 5 0	29.810	59.4	50.8	51.0	0.00	0.3	NNW.	4.0	4.0	Id. : id.
June 22 2 0	29.835	62.8	51.7		0.6	0.6	NNW.	1.5	1.5	Id. : id.
June 22 5 0	29.780	63.2	51.0		0.0	0.0		9.0	9.0	Id. : id. : cirro-str.

June 13^d 4^h. Thermometer in the sun 110° +.
 June 13^d 20^h. The maximum temperature registered is the mean of two thermometers which differed 4°. The difference is probably due to reflected heat.

Göttingen Mean Time of Observation.	BARO- METER Corrected.	THERMOMETERS.			RAIN GAUGE B.	WIND.		STATE OF THE SKY.					
		Dry.	Wet.	Max. and Min.		Esti- mated force.	Direction.	Clouds moving from	Quan- tity of Clouds.	Species of Clouds, &c.			
June 15	in. 29.695	° 59.3	° 52.5	° 69.3	in. 0.00							0-10. 3-0 9-8 9-8 7-0	Cumuli : cir.-str. Ragged cumuli. Scud : sky to NE. Cumuli.
June 16	2 0 29.737 29.782	58.7 58.0	53.0 51.4	48.5 51.4	0.00							10-0 8-5 7-0 7-0	Cumuli : cirri,—breaking. Id. Id. Id. : cirri.
June 17	2 0 29.938	56.9	46.8	46.1	0.00	N.						9-9 9-0 9-8 9-5	Cumuli. Scud : cum. : woolly cir.-cum. : cir.-str. Id. : id. : cirri. Id. : id. : cir.-cum.
June 18	2 0 29.705	60.8	51.2	42.4	0.00	SW. SW. SW.						10-0 10-0 9-0 9-5	Scud : drops of rain. Light showers. Cumuli : nimbi ? cir.-cum. Scud : cir.-str. : like thunder.
June 19	2 0 29.490	54.7	51.8	56.6	0.00	SSE.						10-0 8-8 5-5 10-0	Scud : nimbi. Cum. : nimbi : scud. : cir.-cum. : cir.-str. Towering cum. and nimbi : scud : cirri : like thunder. Thunder-storm gone off to NW. : nimbi : haze.
June 20	2 0 29.457	65.9	60.1	44.4	0.00	SSE. SE.						2-0 5-0 7-0 8-0	Scud : cir.-str. : cum.-str. : cir. Cumuli : reticulated cirri. Cumuli : cirri. Id. : cirrous-haze chiefly : cir.-cum.
June 21	2 0 29.315	69.3	61.8	53.0	0.20	SSW.						0-5 3-0 ...	Cirri. Cumuli : cirri.
June 22	2 0 29.424	64.6	54.6	51.7	0.44	W.						7-0 7-0 7-0 10-0	Cumuli : cirri. Id. : id. : id. : id. Cumuli : cirro-cumuli. Scud : nimbi ? Id. : id. : light rain. Heavy rain.
June 23	2 0 29.447	63.1	54.5	40.0	0.00	SW v. SW v.						7-0 10-0 8-5 7-0	Cumuli : cirri. Cum. : cir.-haze : like thunder : drops of rain. Cum. : cir.-str. : cir.-cum. : cir.-haze. Id. : id. : id. : id.
June 24	2 0 29.173	63.0	55.0	51.7	0.00	SSW v. SSW.						10-0 10-0 10-0 10-0	Cumuli : cirro-cumuli. Scud : nimbi ? Id. : id. : light rain. Heavy rain.
June 25	2 0 29.096	57.7	53.8	51.2	0.01	SSW v. SSW.						10-0 10-0 10-0	Cumuli : cirri. Cumuli : cirri. Id. : id. : id. : id.
June 25	5 0 28.950	53.6	51.8	60.6	48.3							10-0	Heavy rain.

Gottingen Mean Time of Observation.	BARO-METER Corrected.	THERMOMETERS.			RAIN GAUGES A. & B.	WIND.		Clouds moving from	Quan-tity of Clouds.	STATE OF THE SKY.	
		Dry.	Wet.	Max. and Min.		Esti-mated force.	Direction.			Species of Clouds, &c.	
June 26	in. 29-726	58-5	52-2	61-3	in. 0-6	WNW.	WNW.	0-10	Scud : cirro-cumuli.		
June 27	29-787	60-8	52-7	50-3	0-8	WNW.	WNW.	2-5	Id. : cumuli.		
June 28	29-835	63-6	53-5	53-7	1-5	WNW.	WNW.	6-5	Id. : id.		
June 29	29-884	62-7	53-7	53-7	...	SSW.	WNW.	7-5	Cumuli with cir. edges : cirri.		
June 30	29-885	51-6	50-6	64-3	0-0	W ?	SW.	7-0	Scud : light rain.		
July 1	29-839	56-7	55-8	43-2	0-0	W	W.	10-0	Id.		
July 2	29-802	61-0	59-0	59-0	0-8	W	W.	10-0	Smart shower.		
July 3	29-757	60-1	58-9	58-9	1-0	W	W.	10-0	Scud : cumuli : cir.-cum.		
July 4	29-630	55-4	51-1	65-6	1-0	W	W.	9-5	Id. : id. : cirri.		
July 5	29-660	57-8	52-0	51-6	1-3	W	W.	9-5	Id. : id. : id. : like thunder.		
July 6	29-698	58-8	52-1	52-1	1-3	W	W.	9-5	Cumuli : scud : cirri.		
July 7	29-710	59-1	51-7	51-7	...	W : various.	W : various.	2-0	Id.		
July 8	29-716	56-6	50-7	62-2	0-3	N : W.	N : W.	3-5	Id. : id. : hazy sky.		
July 9	29-718	60-5	52-4	46-4	0-5	W	W.	9-5	Id. : cirrous-haze.		
July 10	29-710	61-1	52-4	52-4	0-0	W	W.	5-0	Cum. : cirro-strati : cirri.		
July 11	29-685	63-1	54-4	54-4	0-0	SW.	SW.	8-0	Cumuli : hazy to E.		
July 12	29-602	58-3	52-8	67-1	0-0	SW.	SW.	8-5	Id. : cir.-haze : like thunder.		
July 13	29-565	62-6	56-0	48-3	0-3	SW.	SW.	8-0	Cum. : scud. : cir. : cir.-haze.		
July 14	29-535	64-3	56-6	56-6	0-1	SW.	SW.	10-0	Scud : cirri : light rain.		
July 15	29-498	64-6	55-5	55-5	0-3	SW.	SW.	10-0	Id. : cumuli.		
July 16	29-382	51-7	49-9	62-8	...	SSW ?	SSW ?	9-9	Id. : id. : rain.		
July 17	29-395	50-4	47-8	44-8	...	SW by S.	SW by S.	6-0	Cumuli : cirro-cumuli.		
July 18	29-415	55-3	51-5	51-5	0-5	SW.	SW.	10-0	Scud.		
July 19	29-465	56-9	51-7	63-6	1-0	SW.	SW.	10-0	Cumuli : thick cir.-haze.		
July 20	29-382	50-6	49-6	44-7	...	SSW ?	SSW ?	10-0	Scud, cumuli, &c. : light rain.		
July 21	29-329	60-0	56-7	47-6	...	SW.	SW.	10-0	Id. : id. : id. : id.		
July 22	29-261	59-8	58-1	58-1	0-34	SW.	SW.	10-0	Id. : cir.-str.		
July 23	29-200	63-7	59-2	59-2	0-3	SW.	SW.	10-0	Id. : cirri.		
July 24	28-987	56-2	54-8	62-7	1-5	NNW : 0.	NNW : 0.	9-5	Scud : cir.-cum. : cir.-str. : thick cir.-haze.		
July 25	29-003	59-6	56-0	49-7	1-5	NNW : 0.	NNW : 0.	10-0	Id. : id. : id. : id.		
July 26	29-059	59-2	53-4	53-4	2-8	NNW : 0.	NNW : 0.	8-0	Id. : cir.-str. : cir.-haze to NE.		
July 27	29-139	56-7	51-1	51-1	2-5	NNW : 0.	NNW : 0.	8-5	Cumuli : cir.-str.		
July 28	29-564	52-6	47-8	63-5	0-8	NNW.	NNW.	9-9			
July 29	29-641	57-4	50-7	48-1	1-8			7-5			
July 30	29-718	60-8	52-3	52-3	1-0			8-0			
July 31	29-779	59-6	50-4	50-4	0-8			4-5			

June 26^d. The wind changed on Sunday morning from SW. Blowing very hard on Saturday night and Sunday.
 June 28^d. Observatory rain gauge (A.) placed on 26^d. Readings made at noon, Makerstoun time, in order to be comparable with the garden gauge B.
 July 4^d 23^h. The rain registered is the amount fallen since June 30^d 23^h.
 July 6^d. Porcelain index found immovable in the tube of the maximum thermometer.
 July 6^d—July 15^d. The maximum temperature is obtained from a register thermometer A₂, by Adie, Edinburgh; the minimum is the mean of the indications of the two minimum thermometers A₁ and A₂.

Göttingen Mean Time of Observation.		BARO- METER. Corrected.		THERMOMETERS.			RAIN GAUGES A. & B.		WIND.		STATE OF THE SKY.	
		in.	Wet.	Dry.	Wet.	Max. and Min.	in.	Esti- mated force.	Direction.	Clouds moving from	Quan- tity of Clouds.	Species of Clouds, &c.
July	6	20	0	29-775	48-2	63-7	0-6	0-1			0-10	Indefinable mass : breaking to E.
	23	0	29-700	56-6	38-4	0-000	0-3	0-3			10-0	Cum. to NE : thick cir.-haze.
July	7	2	0	29-620	59-1	52-9	0-8	0-3	S.		10-0	Id. : id. : rain.
	5	0	29-547	54-9	52-0	0-00	0-3	0-3	S.		10-0	Scud : id. : rain.
	20	0	29-420	51-6	49-1	60-9	0-3	0-3		SW : S.	5-0	Scud : cir.-str. : cir.-cum.
	23	0	29-394	58-9	52-0	43-5	0-3	0-3		SSW.	5-0	Piles of cum. : scud. : cir.-cum. : dark to SSW.
July	8	2	0	29-365	60-3	53-4	0-3	0-01		SSW.	7-5	Cum. : nimbi : showers.
	5	0	29-334	55-7	52-7	0-0	0-0	0-0			9-5	Cum. : nimbi : cir.-haze : smart showers.
	20	0	29-343	54-0	52-7	62-7	0-0	0-0		NNW : 0.	9-9	Watery cumuli : cir.-cum.
	23	0	29-331	60-1	55-1	48-0	0-1	0-161		0.	9-9	Ranges of cum. : large cirro-cum.
July	9	2	0	29-321	61-8	55-2	1-0	0-13	SW by S.	SSW : 0.	9-8	Id. : id. :
	5	0	29-286	60-1	53-4	63-7	1-3	0-13	SSW.	SSW : 0.	8-0	Id. : id. : cir.-str.
	20	0	29-286	51-0	50-7	48-7	0-3	0-3		SE.	10-0	Scud : heavy rain.
	23	0	29-178	56-6	55-6	63-4	0-6	0-712	S by E.	SE.	10-0	Id. : id. :
July	11	2	0	29-163	64-3	62-2	1-3	0-64			10-0	Id. : heavy showers.
	5	0	29-195	63-5	62-1	48-7	0-1	0-1		SSW : SSE.	9-9	Cum.-scud : showers lately.
	20	0	29-480	55-8	51-9	67-1	0-4	0-4		NNW : S.	2-5	Scud : cir.-str. : cir.
	23	0	29-539	60-4	54-1	51-8	0-4	0-148		W.	7-0	Cumuli.
July	12	2	0	29-592	65-0	56-9	1-3	0-11	SW.	WSW.	8-0	Id.
	5	0	29-635	64-2	56-0	48-7	1-0	0-11	SW.	SW.	2-0	Id. on horizon : cirri.
	20	0	29-597	58-5	56-6	66-5	0-8	0-8		SW.	10-0	Scud : cumuli.
	23	0	29-608	64-5	59-2	51-6	1-5	0-013	SW.	SW.	9-0	Id. : id. : cir.-cum. : showers around.
July	13	2	0	29-655	64-9	58-1	2-3	0-11		SW.	9-8	Id. : id. : cir.-haze : cirri.
	5	0	29-662	62-7	56-8	48-7	2-0	0-11	SSW.	SW.	4-5	Nimbi? cumuli.
	20	0	29-921	54-8	50-8	66-0	0-5	0-020		WNW : 0.	8-5	Scud : cumuli : cir.-str. : cir.
	23	0	29-943	59-2	52-6	48-4	0-8	0-020		W.	9-2	Ragged cumuli : cir.-haze.
July	14	2	0	29-982	61-1	52-7	1-3	0-02	SW.	W.	7-0	Cumuli.
	5	5	30-008	59-8	51-7	48-7	0-5	0-02			7-0	Id.
	20	0	30-116	55-8	51-3	66-0	0-3	0-3		W.	3-5	Patches of scud : cir. : cir.-str.
	23	0	30-127	60-2	52-9	43-4	0-1	0-002		NW.	6-0	Cumuli : cir.-cum. : cir.
July	15	2	0	30-107	66-0	58-2	0-3	0-00		WNW.	6-0	Cum. : cir.-str. : cirri.
	5	0	30-079	68-5	59-7	48-7	0-3	0-00			9-0	Cirro-strati, &c.
	20	0	30-005	58-5	54-8	70-0	0-0	0-0		SE.	0-1	Patch of cirrus.
	23	0	29-971	68-1	60-6	44-2	0-5	0-000			2-0	Cumuli.
July	16	2	0	29-934	71-7	60-5	0-5	0-00	SE.		1-5	Cirrous mass.
	5	0	29-887	71-0	60-3	43-3	0-3	0-00			1-0	Flame cirri.

See Note July 6^d—July 15th, page 90.
July 16^d—July 22^d. The maxima and minima are from the thermometers of A₂.

Göttingen Mean Time of Observation.		BARO-METER Corrected.		THERMOMETERS.			RAIN GAUGES A. & B.		WIND.		STATE OF THE SKY.		
		d.	h.	m.	in.	Dry.	Wet.	Max. and Min.	in.	Estimated force.	Direction.	Clouds moving from	Quantity of Clouds.
July 17	20	0	29.682	55.9	53.4	67.0	0.000	0.3	0-6		E: 0.	0-10 10.0	Scud: cir.: cirrous haze. Id.: cir.-str.: id.
July 18	2	0	29.700	61.5	55.6	50.6	0.000	0.3	0-6	E.		9.8	Cumuli: cirrous haze.
	5	0	29.698	63.0	56.0		0.00	0.5	0-5	E.		9.5	Scud.: cum.: id.
	20	0	29.725	55.5	53.5	65.3	0.00	1.8	1-8	ENE.		10.0	Scud.
	23	0	29.746	56.1	53.6	51.8	0.00	1.5	1-5	E by N.		10.0	Thick scud: wind in gusts.
July 19	2	0	29.728	57.4	53.8		0.00	1.5	1-5		ENE.	9.5	Scud: cirro-cumuli.
	5	0	29.721	56.5	53.0		0.00	1.0	1-0			9.9	Id.
	20	0	29.648	52.5	49.5	59.8	0.000	0.6	0-6		ENE.	10.0	Light mist: tendency to drizzle.
	23	0	29.632	54.1	49.9	50.8	0.000	0.5	0-5	NE.		10.0	Scud.
July 20	2	0	29.626	54.9	51.6		0.00	1.5	1-5	NE.		10.0	Id.
	5	0	29.608	54.1	52.6		0.00	0.5	0-5			10.0	Id.: light drizzle.
	20	0	29.616	56.6	52.7	57.0	0.012	0.3	0-3	N by E.		2.0	Cumuli: haze on SE. hor.
	23	0	29.627	58.6	52.9	48.7	0.00	0.8	0-8	N by E.		6.0	Scud: cirro-cumuli.
July 21	2	0	29.649	58.8	52.7		0.00	0.5	0-5	N by E.		9.0	Id.
	5	0	29.652	58.0	50.9		0.00	0.5	0-5		N by E: ENE: 0.	2.0	
	20	0	29.824	51.9	47.0	62.6	0.000	1.0	1-0	N.		8.0	Scud.
	23	0	29.861	55.1	48.8	47.8	0.000	0.5	0-5		N.	8.5	Id.
July 22	2	0	29.880	59.5	51.9		0.00	1.0	1-0	NE by N.		3.5	Id.
	5	0	29.900	60.3	53.2		0.00	0.5	0-5			0.3	Detached cumuli.
	20	0	29.999	48.2	46.7	61.6	0.000	0.3	0-3			10.0	Indefinable mass.
	23	0	29.984	60.1	55.6	38.5	0.000	0.0	0-0			0.0	
July 23	2	0	29.955	72.1	61.3		0.00	0.0	0-0			0.1	Patch of scud.
	5	0	29.921	77.9	66.0	78.1	0.00	0.0	0-0			0.7	Detached cumuli to S. and N.
	20	0	29.752	56.5	53.4	70.8	0.000	0.3	0-3			10.0	Flaky cumuli.
	23	0	29.750	60.2	55.1	54.0	0.000	0.3	0-3		S by E.	10.0	Cumuli: patches of cir.-haze.
July 25	2	0	29.740	62.9	56.5		0.00	0.5	0-5			9.0	Id.:
	5	0	29.724	62.2	56.2		0.00	0.5	0-5	E.		10.0	Id.: hazy.
	20	0	29.788	55.5	52.9	65.8	0.000	0.3	0-3			10.0	Loose cumuli: cirro-cum.: breaking.
	23	0	29.813	62.7	56.8	51.3	0.000	0.1	0-1		SSE: NNE.	8.5	Dark cum.: like thunder.
July 26	2	0	29.821	63.6	57.6		0.00	0.6	0-6	E by N.		8.5	Heavy, dark, and towering white cum.: drops of rain.
	5	0	29.845	61.9	55.4		0.00	0.4	0-4		SE: W.	5.5	Cum.: cir.-cum.: light shower since 2h.
	20	0	29.933	59.8	55.5	66.4	0.005	0.1	0-1		W by N.	8.0	Loose cum.: cir.-cum.: cir.: cir.-haze.
	23	0	29.936	62.0	53.8	51.0	0.00	0.3	0-3			9.5	As at 20h: stormy-like.
July 27	2	0	29.925	64.2	55.0		0.00	0.1	0-1			9.8	Nearly as before.
	5	0	29.896	61.5	54.8		0.00	0.5	0-5		W: 0.	9.9	Nimbi: heavy cum.: cir.: rain to E.

See note, July 16^d—July 22^d, page 91.
 July 23^d—Aug. 3^d. The maxima and minima are the means from the thermometers of A₂ and D (two thermometers by Dunn, Edinburgh), excepting on July 29^d, when they are from D alone.

Göttingen Mean Time of Observation.	BARO- METER Corrected.	THERMOMETERS.			RAIN GAUGES A. & B.	WIND.		STATE OF THE SKY.		
		Dry.	Wet.	Max. and Min.		Esti- mated force.	Direction.	Clouds moving from	Quan- tity of Clouds.	Species of Clouds, &c.
July 27	29-831	54.7	52.4	6-68	0-6		NNW.	0-10	Scud : cum. : cirro-strati : drops of rain.	
July 28	29-760	59.0	54.0	46.6	0.4	W.	W.	10.0	Nearly as at 20 ^h .	
July 29	29-738	59.0	55.2	0.00	1.0	W.	W.	10.0	More muddled than before.	
July 30	29-671	65.5	59.2		0.8		E.	3.0	Cum. : cir. : cir.-haze : rain since 2 ^h .	
July 31	29-725	52.9	47.8	66.0	0.5		N.	7.5	Loose cumuli.	
Aug. 1	29-751	55.2	51.0	47.3	1.0	N.	W : 0.	8.8	id. : cirri.	
Aug. 2	29-763	59.3	50.6	0.02	0.6	N.	N.	8.0	Cumuli : id.	
Aug. 3	29-751	59.9	50.7		0.8		N : W ?	Id.	
Aug. 4	29-836	54.0	48.8	60.6	0.0		N.	7.0	Loose cumuli : cirri.	
Aug. 5	29-828	60.6	53.5	41.1	0.4			9.0	Id.	
Aug. 6	29-827	65.1	56.9	0.00	0.3			9.2	Id. : cirri.	
Aug. 7	29-833	64.9	57.8	65.9	0.4			8.8	Id. : id. : cir.-haze.	
Aug. 8	30-050	58.8	56.0	71.7	0.0			0.2	Cirri to N. and E.	
Aug. 9	30-034	66.9	61.1	47.1	0.0		SSW.	1.0	Scud : cum. : cirri.	
Aug. 10	30-003	75.1	62.3	0.00	0.5		SW.	3.0	Cumuli.	
Aug. 11	29-972	74.6	63.5		0.6		SW.	3.0	Id.	
Aug. 12	29-874	63.4	58.0	75.3	0.6		SW ?	10.0	A few cumuli : cirri.	
Aug. 13	29-841	69.3	60.4	47.6	0.5		SW.	10.0	Cumuli : cirreous haze.	
Aug. 14	29-806	70.6	62.8	0.00	0.5			9.0	Id. : id.	
Aug. 15	29-775	71.0	61.9		0.3			4.0	Cirri : id.	
Aug. 16	29-807	51.6	50.1	73.0	0.0			8.5	Cumuli.	
Aug. 17	29-787	70.4	61.1	44.4	0.1		S.	6.5	Id. : cirro-cumuli.	
Aug. 18	29-765	69.8	62.7	0.00	0.0		SSW.	9.0	Cumuli : cir. : hazy to E. : stormy-like.	
Aug. 19	29-732	70.3	63.4		0.4		WNW.	10.0	Scud : cum. : hazy.	
Aug. 20	29-490	58.3	55.1	73.7	0.8		SW.	10.0	Scud.	
Aug. 21	29-452	55.9	52.3	50.5	1.8		SW.	10.0	Id.	
Aug. 22	29-436	62.2	58.0	0.00	2.0		SW.	6.0	Id. : cumuli : sky in zenith.	
Aug. 23	29-479	64.6	55.1		1.0		SW : 0.	6.0	Id. : id. : cirri.	
Aug. 24	29-390	61.7	59.5	67.4	1.8		SW.	10.0	Scud.	
Aug. 25	29-400	65.1	61.2	53.6	1.8		SW.	9.9	Id. : light drizzle.	
Aug. 26	29-397	66.0	61.9	0.00	2.3		SW.	10.0	Id. : id.	
Aug. 27	29-380	65.7	60.9		2.3		SW.	9.9	Id. : id.	
Aug. 28	29-586	54.4	50.9	69.3	0.3		SW.	5.0	Linear and mottled cirri.	
Aug. 29	29-606	60.9	53.7	46.0	0.6		SW.	7.0	Loose cum. : woven cir. : cir.-haze.	
Aug. 30	29-593	64.5	54.9	0.00	1.0		SW : 0.	4.0	Detached cum. : id.	
Aug. 31	29-586	64.5	55.7	65.9	1.5		SW by S.	3.0	Id. : cirri : id.	

Aug. 4^d, 5^d, 7^d, and 12^d till 25^d. The max. and min. are from D.
 Aug. 6^d, 8^d, 9^d, and 10^d. The max. and min. are from A₂ and D.

Göttingen Mean Time of Observation.	BARO- METER Corrected		THERMOMETERS.		RAIN GAUGES A. & B.	WIND.		STATE OF THE SKY.			
	d.	h. m.	Dry.	Wet.		Max. and Min.	in.	Esti- mated force.	Direction.	Clouds moving from	Quan- tity of Clouds.
Aug. 7	20	0	57.7	55.5	66.4	0.0	0-6		SW: 0.	0-10	Scud: cir.-str.: haze.
	23	0	61.9	59.1	50.1	0.020	0.0		SW.	10.0	Id.
Aug. 8	2	0	68.2	61.7		0.00	0.3		SW.	10.0	Heavy cumuli: very hazy to E.
	5	0	66.1	61.5			0.5		SW.	10.0	Id.
	20	0	62.0	60.0	69.3		0.8		SW.	10.0	Scud: cum on E. hor.
	23	0	65.9	61.3	57.2	0.062	1.5		SW: W?	7.0	Id.: cir.-cum.: cir.: cir.-haze.
Aug. 9	2	0	63.3	61.6		0.03	0.8	SW.	SW.	8.0	As at 23 ^h : showers.
	5	0	68.8	61.6			0.6	SW.		7.0	Cumuli $\frac{1}{2}$: cir. and cir.-haze 6 $\frac{1}{2}$.
	20	0	65.1	61.8	69.4		0.3			5.0	Cirro-cum.: cir.: cir.-haze.
	23	0	73.8	66.2	55.0	0.030	0.3			5.0	Clouds as at 20 ^h , scattered.
Aug. 10	2	0	78.9	67.8		0.02	0.1		S.	9.0	Cum.: cir.-str.: very hazy and like thunder.
	5	0	68.8	66.8				Various.	10.0	Nimbi: cum.: rain: thunder storm.
	20	0	54.1	52.9	78.2		0.5			10.0	Scud.
	23	0	58.8	53.8	53.2	1.542	1.3	NW.		10.0	Loose cum.: hazy clouds.
Aug. 11	2	0	62.9	54.6		1.36	1.8	NW.	NNW: 0.	8.8	Id.: loose cir.-cum.: cir.
	5	0	63.7	53.7			2.0	NW by N.	NNW: 0.	5.0	Cumuli: mottled cirri.
	20	0	58.6	57.8	63.9		0.6	SW.	SW.	10.0	Scud.
	23	0	62.6	58.7	52.3	0.202	0.8	SW.	SW.	10.0	Id.
Aug. 12	2	0	65.9	61.3		0.15	0.8	SW.	SW.	9.8	Id.: sky to NE.
	5	0	63.3	61.0			0.8	SW.	SW.	10.0	Id.
	20	0	63.1	61.4	67.3		1.5	SW.	SW: 0.	9.5	Misty scud: matted, &c. cirri.
	23	0	67.0	63.0	58.0	0.003	1.5	SW.	SW.	9.0	Id.: id.
Aug. 13	2	0	68.1	62.3		0.00	1.8	WSW.	WSW.	5.0	Id.: varieties of cirri.
	5	0	66.1	61.7	69.1		1.0	WSW.	WSW.	8.5	Cumuli: id.: &c.
	20	0	58.8	57.5	58.9		0.3			9.0	Thin scud: cir.-cum.: pectinated cir.
Aug. 14	20	0	68.8	64.0	70.1	0.000	0.0		SW.	4.0	Cum.: scud: flame and hazy cirri.
	23	0	71.9	65.1	51.2	0.00	0.5		SW.	9.0	Cum: flame and linear cir.: like thunder.
Aug. 15	2	0	71.8	64.3			0.3		SW.	9.0	Cir.-scud.: piles of cum.: cir.-str.: cir.-haze: cir.
	5	0	55.5	52.8	74.8			NE: 0.	4.0	Loose cum.: cir.-cum.
	20	0	59.0	53.6	53.7	0.000	0.5		ENE.	9.8	Id.: sky on NE. hor.
Aug. 16	2	0	62.5	56.0		0.00	0.5	SE.	SSE.	8.0	Id.
	5	0	61.8	56.7			0.3	SE.	SE.	9.9	Scud: id.
	20	0	57.8	55.8	65.6		0.0			10.0	Nearly homogeneous.
	23	0	64.9	60.9	55.5	0.000	0.3			10.0	Id., breaking.
Aug. 17	2	0	72.3	66.2		0.00	0.1		SW: 0.	1.0	Scud: cirri.
	5	0	77.5	69.5			0.3	SSE.		2.0	Cumuli: id.

See note, Aug. 6^d, 8^d, 9^d, and 10^d, page 93.
 Aug. 11^d 1^h. 1.542 inch. of rain must have fallen in less than 15^h, probably in less than 12^h.

Göttingen Mean Time of Observation.	BARO- METER Corrected.		THERMOMETERS.		RAIN GAUGES A. & B.	WIND.		STATE OF THE SKY.				
	d	h. m.	in.	°	Wet.	Max. and Min	in.	Esti- mated force.	Direct.on.	Clouds moving from	Quan- tity of Clouds.	Species of Clouds, &c.
Aug. 17	23	0	29.734	63.3	61.3	0-0	0-0		SSW : 0.	0-10.	Cum. : loose cir.-cum. : cir. : cir.-haze.
	23	0	29.739	73.2	67.7	57.0?	0.000	0.0		SSW.	7.0	Vertebrate cir. cum.
Aug. 18	2	0	29.700	78.1	69.8		0.00	0.3		SSE.	5.0	Cum. : cir. : haze.
	5	0	29.664	81.3	68.5		0.00	0.3		SSW.	6.0	Scud : rocky cumuli : cir. : cir.-haze.
Aug. 19	2	0	29.570	62.0	60.6	82.3	0.000	0.0		SSE.	7.0	Loose cum. : haze : thunder, and during the night.
	23	0	29.543	73.5	67.3	59.7	0.00	1.3	SSW.	SSW.	10.0	A few cum. : cir.-haze : cir.
	2	0	29.565	70.8	65.3		0.00	0.8	SSW.	SSW.	10.0	Cum. : large cir.-cum. : haze.
	5	0	29.520	67.8	63.0		0.00	0.0			10.0	Haze, &c. : nearly homogeneous.
Aug. 20	2	0	29.550	59.6	55.6	74.0		SSW.	2.8	Cum. : cirri.
	23	0	29.568	60.6	57.9	58.2	0.000	0.3		SW.	10.0	Scud : light drizzle.
Aug. 20	2	0	29.575	60.9	54.3		0.00	1.3	SSW.	SSW.	10.0	Id. : haze : stormy-like.
	5	0	29.554	61.7	57.8	64.2	0.00	2.0	SSW.	SSW.	10.0	Id. : cir.-str. : haze : slight drizzle.
Aug. 21	20	0	29.881	49.8	47.3	65.2	0.0	0.0		SSW : 0.	9.5	Mottled grey mass : loose cir.-cum.
	23	0	29.882	58.6	52.9	43.8	0.046	0.0	S.	S.	9.2	Cir.-cum, &c. : more open than at 20 ^h .
Aug. 22	2	0	29.872	65.9	57.8		0.02	0.0	S.	S.	9.9	Heterogeneous mass.
	5	0	29.847	64.2	57.1	48.1	0.00	0.3			10.0	Id., denser.
Aug. 23	2	0	29.716	58.1	56.0	67.6	0.000	0.3		SSW.	1.0	Detached loose cum. : cirri.
	23	0	29.667	67.6	62.1	48.3	0.00	0.3		SSW.	1.0	Id. : id.
Aug. 23	2	0	29.606	73.7	65.0		0.00	0.1		SSW.	8.0	Cumuli : woolly cir.-cum. : hazy on hor.
	5	0	29.540	72.8	63.3		0.00	0.3		SSW.	8.0	Patches of scud : cir.-cum. : cir.-str.
Aug. 24	2	0	29.483	55.5	53.5	75.9	0.040	0.4		SW.	10.0	Scud : light drizzle.
	23	0	29.541	54.6	50.8	52.3	0.01	0.3			10.0	Like buttermilk agitated : cir.-str. to N.
Aug. 24	2	0	29.582	57.6	52.9		0.00	0.3			10.0	As at 23 ^h : light showers.
	5	0	29.606	59.8	54.3		0.00	0.0			9.9	Detached cum. : more broken.
Aug. 25	2	0	29.761	46.8	45.4	60.8	0.000	0.0		ENE.	0.5	Cirri.
	23	0	29.774	58.8	53.9	36.7	0.00	0.8	NE.	ENE.	8.0	Loose cum. : cumuli.
Aug. 25	2	0	29.762	61.0	54.5		0.00	0.8		ENE.	4.0	Cumuli.
	5	0	29.757	59.1	53.6		0.00	1.0		ENE.	2.5	Loose cumuli : cirri.
Aug. 26	2	0	29.780	54.9	52.7	61.6	0.054	0.5	NNE.	NE : 0.	7.5	Scud : cir.-cum. : cirri.
	23	0	29.801	57.8	53.7	45.2	0.06	0.6	NNE.	NNE.	8.5	Loose cum. : cir.-cum.
Aug. 26	2	0	29.800	60.6	54.6		0.06	0.6	NNE.	NE : SSW.	5.5	Patches of scud. : cumuli.
	5	0	29.806	58.8	54.4		0.00	0.8	NE.	NE.	9.8	Loose cumuli : cirro-cum.
Aug. 27	2	0	29.861	55.6	53.4	61.5	0.000	0.3		NE.	10.0	Scud.
	23	0	29.864	59.0	54.8	54.3	0.00	0.3	NE.	NE.	8.0	Id. : cir.-cumuli.
Aug. 27	2	0	29.849	63.9	57.7		0.00	0.8	NE.	NE.	5.0	
	5	0	29.839	63.8	57.0	64.6	0.00	0.3	NNE.	NNE.	5.0	

Aug. 17^d. Index of max. thermometer shaken.
 Aug. 18^d 2^h 50^m. Observatory wind-vane put up to-day ; from it the directions of the wind are afterwards taken.
 Aug. 25^d—26^d. Thermometer in the sun 110°.
 Aug. 25^d and after, the max. and min. of temperature are from the pair of register thermometers A₁, of which, however, the maximum is a new thermometer, the old one having been broken in the carriage to Edinburgh, where it had been sent to obtain a new index.

Göttingen Mean Time of Observation.	BARO- METER (Corrected.)		THERMOMETERS.			RAIN GAUGES A. & B.	WIND.		STATE OF THE SKY.		
	d	h	Dry.	Wet.	Max. and Min.		Esti- mated force.	Direction.	Clouds moving from	Quan- tity of Clouds.	Species of Clouds, &c.
Aug. 28	20	0	56.5	55.8	64.9	in.	0-6			0-10	Scud : light mist or drizzle.
	23	0	63.1	60.5	54.7	0.037	0-0		SSW.	10.0	Loose cumuli : sky in patches.
Aug. 29	2	0	70.0	64.4		0.00	0-1	SW by W.	SSW.	4.0	Cumuli.
	5	0	72.0	64.3			0-1	WSW.		1.0	Detached cumuli round hor.
Aug. 30	0	0	54.8	51.6	72.9	0.000	0-4	W by S.	WSW : 0.	9.8	Scud : cirro-str. to E. and N., &c.
	2	0	59.1	51.8	54.6	0.00	0-4	NW by N v.	N by W.	9.9	Cumuli 1½ : cir.-haze : stormy-like.
	5	0	49.9	49.9			0-5	NW by N.	NNW.	10.0	Cum. 2½ : id.
	5	0	57.9	49.5			0-3	NW by N.	W : SW.	8.5	Watery cum. : diffuse cir.-cum. : cir.-haze.
Aug. 31	2	0	47.4	44.9	60.8	0.000	0-1	W by S.	WNW.	0.0	Detached cum. : cirri.
	5	0	57.0	49.4	37.2	0.00	0-6	WNW.	W by S : W by N : NW.	6.0	Cum. : hills of cum. : cirri.
	5	0	61.1	52.3			0-5	SW by W v.	SW.	6.0?	Scud : cum. : chiefly cir.-haze.
	5	0	58.9	55.7			0-6	SW by W.		9.0	
Sept. 1	2	0	53.7	52.9	62.2	0.114	0-1	SW.	SSW : 0.	10.0	Scud, &c.
	2	0	60.1	58.9	48.1	0.09	0-5	SW.	SSW.	10.0	Id. : occasional showers.
	5	0	66.3	62.7			0-8	SW v.	WSW.	9.8	Id. : loose cum. : cirri.
	5	0	65.7	62.6			0-8	SW v.	W by N.	10.0	Id. : cirrous haze.
Sept. 2	2	0	63.5	61.7	68.1	0.044	1-5	SW.	W.	10.0	Scud.
	2	0	64.2	61.8	60.4	0.03	1-5	SW.	WSW.	10.0	Id.
	5	0	64.9	62.2			1-5	SW by S.	WSW.	10.0	Id.
	5	0	64.1	61.7			2.5	SSW.	SW : WSW.	9.9	Id. : drops of rain.
Sept. 3	2	0	62.0	59.6	65.9	0.003	1-5	SW v.	W by S.	8.8	Thin scud : loose cir.-cum. : sky in zen.
	2	0	62.8	60.1	59.8	0.00	1-0	SW by W v.	WSW.	10.0	Scud.
	5	0	62.9	59.9			2.0	SW by W v.	WSW.	10.0	Id.
	5	0	61.0	59.2	66.3		1-5	SW.	WSW.	10.0	Id. : light rain.
Sept. 4	20	0	47.4	45.8	66.3	0.053	0-1	NW by W.	W by S : 0.	8.5	Cirri : cirrous haze.
	23	0	56.9	53.4	42.5	0.02	0-3	SW.	W by N ?	10.0	Scud : id. near hor.
Sept. 5	2	0	62.5	56.8			0-3	SW by W.	SW.	10.0	Thick scud.
	5	0	60.2	57.7			0-4	SW by S.	SSW.	10.0	Id, &c.
Sept. 6	20	0	54.4	51.2	64.2	0.136	0-3	W by S.	W.	1.5	Scud : cirro-cumuli.
	23	0	59.0	53.5	48.8	0.15	0-8	NW.	WNW.	5.0	Loose cumuli : scud.
	5	0	61.2	55.8			0-4	SW by S.	NW.	9.0	Id. : id.
	5	0	61.2	55.8				NW.	9.0	Cumuli : large cir.-cum.
Sept. 7	20	0	45.0	44.0	62.8	0.006	0-3	SW by W.	S.	5.0?	Feather cirri.
	23	0	57.1	53.5	38.2	0.00	0-0		SSE.	9.8	Loose cum. : cir.-str. : cir.-haze on E. hor.
	5	0	61.6	56.1			0-0		S by E.	9.0	Id. : id.
	5	0	62.8	56.9			0.5	SE.		10.0	Cir.-str. : thick cir.-haze : stormy-like.

Aug. 30^d 0^h. Observation made at this time by mistake instead of 29^d 23^p.

Göttingen Mean Time of Observation.	BARO- METER Corrected.	THERMOMETERS.		RAIN GAUGES A. & B.	WIND.		Clouds moving from	Quan- tity of Clouds.	STATE OF THE SKY. Species of Clouds, &c.
		Dry.	Wet.		Max. and Min.	Esti- mated force.			
Sept. 7 20 0	in. 29.218	° 55.3	° 66.1	in. 0.073		WSW.	0-10. 10.0	Scud : light rain. Id. : id.	
Sept. 8 2 0	29.191	56.4	0.05	NNE.	ENE.	10.0	Id. : id.	
Sept. 8 5 0	29.180	58.2	56.7		NNE.	NE.	7.0	Loose cum. : scud : cum : cir.	
Sept. 8 20 0	29.172	59.3	55.1		N by E.	N by W.	10.0	Homogeneous scud : light drizzle.	
Sept. 9 2 0	29.126	52.7	60.7	0.020	SSW.	S by W ?	10.0	Scud.	
Sept. 9 5 0	29.087	57.5	49.3	0.02	SSW.	SW by S.	9.0	Id. : cum. on hor. : cir.-cum. : cir. in sheets. Id. : towering cum. : cir. : black to NW.	
Sept. 10 2 0	29.049	63.3	57.8		SW by W.	SSW.	6.0	Thin scud : cir.-cum.	
Sept. 10 5 0	29.035	62.2	56.2		NNW.	NW.	9.0	Scud : cum., &c. above.	
Sept. 11 20 0	29.114	51.4	66.0	0.041	NNW.	NW.	9.8	Scud : cum. : cirri.	
Sept. 11 23 0	29.163	58.7	45.4	0.02	NW by N.	NW : NNW.	8.2	Id. : cirro-cum.	
Sept. 12 2 0	29.186	60.8	54.9			NW : N.	10.0	Scud : cir.-haze to S.	
Sept. 12 5 0	29.214	61.1	54.6			N.	9.8	Id. : cumuli rising to N.	
Sept. 11 20 0	29.583	50.9	48.8	0.117	WNW.	NNW.	6.0	Cumuli : cir.-haze to SW.	
Sept. 12 2 0	29.641	57.6	48.0	0.08	NNW.	NNW.	1.5	Cum. to W. : pencils of cirri 75° long.	
Sept. 12 5 0	29.678	62.0	54.0		NNW.	10.0	Very thick, like buttermilk : cir.-cum., &c.	
Sept. 13 2 0	29.712	60.4	54.5			SW.	10.0	Nearly homogeneous : patches of scud.	
Sept. 13 5 0	29.886	50.5	49.5	0.006		SW by W.	9.9	Diffuse cir.-cum.	
Sept. 13 23 0	29.905	57.0	53.7	0.00		SW.	6.0	Id.	
Sept. 13 5 0	29.899	61.1	56.8			NNW : 0.	9.9	Homogeneous scud ? breaking.	
Sept. 14 2 0	29.897	62.1	58.4			WSW.	10.0	Id.	
Sept. 14 5 0	29.981	58.0	56.8	0.001			9.9	Id.	
Sept. 14 23 0	29.998	63.4	60.1	0.00			9.9	Id. : cum. on ESE. hor.	
Sept. 15 2 0	29.997	67.7	63.2				9.5	Thick mist : large loose cir.-cum.	
Sept. 15 5 0	29.987	66.2	62.7				6.5	Cumuli : id.	
Sept. 15 20 0	29.939	54.0	52.8	0.000		S.	9.8	Loose edged cumuli.	
Sept. 15 23 0	29.935	63.3	58.9	0.00		SSE.	9.5	Id.	
Sept. 16 2 0	29.883	65.9	59.3			SW by S.	10.0	Cir.-cum.-scud. : cir.-cum. : cir.	
Sept. 16 5 0	29.863	64.3	58.1			SSW ?	10.0	Scud : cum. : cir.-haze.	
Sept. 16 20 0	29.808	57.8	55.6	0.000		SSW.	8.5	Id. : light rain.	
Sept. 16 23 0	29.798	64.7	59.6	0.00		SSW.	10.0	Scud : loose cum. : cir.-cum.	
Sept. 17 2 0	29.763	65.7	61.0			W by S by W.	10.0	Scud.	
Sept. 17 5 0	29.720	64.9	60.6			NE by N.	10.0	Id.	
Sept. 17 20 0	29.411	58.4	55.6	0.000		NNW.	5.0	Loose cumuli.	
Sept. 17 23 0	29.379	63.6	59.9	0.00		NNW : WSW.	3.5	Cumuli : loose cir.-cum.	
Sept. 18 2 0	29.370	61.8	58.1			SSE.			
Sept. 18 5 0	29.419	58.5	53.8						
Sept. 18 20 0	29.344	49.8	48.6	0.047					
Sept. 19 2 0	29.315	52.0	50.0	0.02					
Sept. 19 5 0	29.298	55.1	51.1						
Sept. 19 20 0	29.282	57.8	51.7						

Göttingen Mean Time of Observation.		BARO-METER Corrected.	THERMOMETERS.			RAIN GAUGES A. & B.	WIND.		STATE OF THE SKY.	
			Dry.	Wet.	Max. and Min.		Estimated force.	Direction.	Clouds moving from	Quantity of Clouds.
Sept. 19	0 0	in. 29.245	49.5	48.5	58.7	in. 0.005	0-6	SSE.	0-10.	Cum. : scud : cir.-cum. : cir. to NE.
Sept. 20	2 0	29.236	55.0	50.9	47.4	0.00	0-1	SSE.	2-0	Cum. on hor. : cirrous haze.
Sept. 20	2 0	29.218	59.6	51.4			SE.	S by E.	5-0	Loose edged cum. : cir.-haze.
Sept. 20	5 0	29.221	60.2	50.9			S by E.	SE.	1-5	Detached cum. : cir.
Sept. 20	0 0	29.312	43.4	42.8	61.8	0.081	0-0	NE ?	10-0	Homogeneous mass : heavy mist.
Sept. 20	2 0	29.346	49.0	48.0	36.5	0.07	0-0	NE.	9-5	Scud : nimbi ? smart shower.
Sept. 21	2 0	29.331	56.0	50.7			0-3	NE.	3-0	Cumuli.
Sept. 21	5 0	29.332	54.1	49.5			0-3	NE.	8-0	Cumuli : loose cir.-cum.
Sept. 20	0 0	29.345	49.9	47.9		0-0	NE : SSE.	10-0	Two strata of scud : cir.-haze.
Sept. 20	2 0	29.344	54.0	48.6	43.7	0.007	0-5	N.	10-0	Cumuli on hor.—breaking
Sept. 22	2 0	29.333	55.0	49.1		0.00	0-5	N.	10-0	Scud, chiefly cirrous haze.
Sept. 22	5 0	29.297	52.9	48.5			0-3	N.	10-0	Id. : rain.
Sept. 20	0 0	29.269	55.9	53.0	56.7	0.265	2-3	NNE.	9-9	Scud : occasionally drops of rain.
Sept. 20	2 0	29.289	57.4	53.7	42.7	0.15	2-5	NNE.	9-8	Id. : loose cum.
Sept. 23	2 0	29.311	58.3	53.9			1-8	NE by N.	9-8	Id. : cum. : cirrous clouds.
Sept. 23	5 0	29.324	56.9	53.9			1-8	NE.	3-0	Id. : id.
Sept. 20	0 0	29.332	49.6	49.2	58.3		0-0	NNE.	10-0	Scud : rather heavy rain.
Sept. 20	2 0	29.362	49.0	48.8	48.5	1.638	0-0	NE by N.	10-0	Id. : heavy rain.
Sept. 24	2 0	29.361	53.8	52.5		1.54	0-6	NNE.	9-9	Id. : breaking.
Sept. 24	5 0	29.377	55.0	52.7			0-4	NE by N.	10-0	Id. : large cir.-cum.
Sept. 25	20 0	29.881	49.2	48.4	50.0		0-3	NNE.	9-8	Scud, &c. : light rain.
Sept. 25	23 0	29.930	50.8	49.6	49.7	0-6	NE by N.	10-0	Id. : Scotch mist.
Sept. 26	2 0	29.957	50.6	49.7		0.25	0-6	NE by E.	10-0	Id. : id.
Sept. 26	5 0	29.975	50.9	48.4			0-6	NE.	10-0	Id. : indefinable to N.
Sept. 20	0 0	30.010	47.2	46.2	52.3		0-0	NE.	8-5	Scud : loose cum. : sky on NW. hor.
Sept. 20	2 0	30.007	52.7	47.6	46.1	0.345	1-0	NE by N : ENE.	7-0	Loose cumuli.
Sept. 27	2 0	30.003	54.3	48.1		0.02	1-0	N by E : E.	9-5	Id. : sky in zen. and to E.
Sept. 27	5 0	30.006	52.6	48.6			0-5	NNE.	5-0	Scud : loose cumuli.
Sept. 20	0 0	30.116	46.4	43.5	55.1		0-5	N.	10-0	Scud : breaking.
Sept. 20	2 0	30.141	48.5	44.4	45.1	0.010	1-0	NNE.	10-0	Id. : light rain.
Sept. 28	2 0	30.143	50.3	45.0		0.00	2-0	NE by N.	9-5	Id. : sky in zen. and to N.
Sept. 28	5 0	30.151	49.7	45.6			1-5	NNE v.	3-5	Id. : cir.-cum.
Sept. 20	0 0	30.237	48.4	43.9	51.5	0.172	0-6	NNE.	2-0	Loose cumuli.
Sept. 20	2 0	30.243	52.5	47.6	43.9	0.12	0-8	E by N.	9-0	Scud : showers around.
Sept. 29	2 0	30.245	53.8	46.3			1-8	ENE.	2-5	Id.
Sept. 29	5 0	30.233	51.6	46.6			1-0	NE by N.	3-5	Id. : cumuli : part of a rainbow to NE.
Sept. 20	0 0	30.212	41.0	40.4	54.6		0-0	ENE.	2-0	Cirro-cumuli.
Sept. 20	2 0	30.224	52.7	47.4	52.8	0.010	0-5	NE by E.	3-0	Cumuli.
Sept. 30	2 0	30.183	53.7	47.0		0.00	1-0	ENE.	3-5	Loose cumuli.
Sept. 30	5 0	30.159	51.6	45.7			0-6	ENE.	4-0	Id. : cumuli.

Göttingen Mean Time of Observation.	BARO- METER. Corrected.		THERMOMETERS.		RAIN GAUGES A. & B.	WIND.		Clouds moving from	Quan- tity of Clouds.	Species of Clouds, &c.
	in.	°	Dry.	Wet.		Max. and Min.	Esti- mated force.			
Sept. 30	0	30.140	39.5	38.5	55.6	0.0		NNW; E.	0-10	Cir.-str. : cir.-cum. : flame cir.
	23	30.130	50.4	46.6	37.0	0.0		NW.	3.0	Cumuli : cirro-cumuli.
Oct. 1	2	30.113	52.9	47.9	55.7	0.0		W by S : N : NW.	8.0	Scud : two strata of loose cum.
	5	30.101	53.4	48.6	48.4	0.1		N.	10.0	Cumuli.
Oct. 2	20	30.019	44.5	41.7	59.6	0.3	N.	NE.	9.8	Thin scud, &c. : sky to N.
	23	30.023	47.8	42.0	44.1	0.5	NNE.	NE.	9.9	Scud : loose cumuli : sky to S.
Oct. 3	2	30.005	48.7	42.7		0.5	NNE.	NNW.	9.9	Id. : cir.-haze.
	5	29.972	47.0	41.8		0.1		NNW.	9.2	Id. : cumuli : cir. to S.
Oct. 4	2	29.988	31.6	31.0	49.9	0.0		WNW ?	0.2	Cirri : hoar frost.
	23	29.994	42.8	39.5	27.7	0.0		WNW.	0.5	Detached cumuli.
Oct. 5	2	29.963	48.8	42.7		0.4		WNW.	0.2	Patches of scud : cum. : cir.
	5	29.932	49.3	43.4		0.3		NNW.	0.1	Patches of cirri : hazy on E. hor.
Oct. 6	2	30.005	55.9	48.6		0.6	NNW.	N.	9.8	Scud : large cir.-cum.
	5	30.017	54.6	49.2		0.5	NNW.	N.	7.5	Cumuli : id.
Oct. 7	2	30.057	45.5	43.5	56.6	0.0	NNW.	N.	10.0	Hazy scud.
	23	30.050	52.6	46.4	45.1	0.4	NNW.	W by N : NW ?	9.9	Scud : loose cumuli : rain to ENE.
Oct. 8	2	30.066	54.5	47.9		0.3	NW by N.	WNW : N.	5.0 ?	Cirro-strati : cirri.
	5	30.045	52.8	48.7		0.1	WNW.	WNW : N.	8.0 ?	Detached cumuli : nests of cir. : flame cir.
Oct. 9	2	30.037	50.7	47.8	0.8	W by S.	WNW.	7.5	Scud : cir.-edged cum. : cir. : gusty.
	23	30.064	54.9	50.6	0.4	WSW.	NW by W : N.	10.0	Scud : cir.-cum. : cir.-haze.
Oct. 10	2	30.065	56.5	50.6		0.1	N by E ?	NNW.	8.5	Scud : cir. : cir.-haze.
	5	30.076	56.5	50.6		0.1		NNW.	8.0	Patches of scud : varieties of cirrus.
Oct. 11	2	30.117	54.7	51.9	56.2	0.4	W.	W by S.	10.0	Scud : cirrus clouds above.
	23	30.122	59.4	53.9	48.1	0.1	SW by W.	W by S.	8.0 ?	Id. : linear, &c., cirri.
Oct. 12	2	30.125	62.1	54.5		0.3	SW.	SW by S.	8.0 ?	Patches of scud : varieties of cirri.
	5	30.094	53.1	48.6		0.8	SW by S.	SW by S.	8.0 ?	Id. : id.
Oct. 13	2	30.138	59.8	53.2		0.5	N by W.	NNW ?	9.2	Scud.
	23	30.122	59.4	53.9	48.1	0.1	SW by W.	WNW.	1.5	Patches of scud : linear cir. : cir.-haze.
Oct. 14	2	30.125	62.1	54.5		0.3	NW ?	NNW ?	1.5	Cum. to E. : id. : id.
	5	30.138	59.8	53.2		0.5	N by W.	NNW ?	6.0	Loose cum. 1½ : woolly cir.-cum.

Oct. 8^d 3^h. Maximum height of barometer probably at this time, reading corrected 30.302.

Göttingen Mean Time of Observation.	BARO- METER Corrected.		THERMOMETERS.			RAIN GAUGES A. & B.		WIND.		STATE OF THE SKY.			
	d.	h.	m.	in.	°	°	°	in.	Esti- mated force.	Direction.	Clouds moving from	Quan- tity of (Clouds.	Species of Clouds, &c.
Oct. 11	20	0	0	30.196	35.4	62.6	0.004	0-6.	0-0		NW ?	0-10.	Linear and waved cir. to E. : hoar frost.
	23	0	0	30.191	45.1	33.7	0.00	0-0	0-0			4-0	Cumuli : varieties of cirri.
Oct. 12	2	0	0	30.142	49.8		0.00	0-1	0-0			4-0	Linear, waved, &c., cirri.
	5	0	0	30.118	50.6			0-0	0-0			6-0	Feathery, woolly, &c., cirri.
	20	0	0	30.070	31.6	54.8		0-0	0-0			0-2	Linear cirri : hoar frost.
	23	0	0	30.055	43.8	29.8	0.000	0-0	0-0			3-0	Linear, mottled, &c., cirri.
Oct. 13	2	0	0	29.993	49.6		0.00	0-8	0-8	SW.		8-0	Varieties of cirri.
	5	0	0	29.962	49.4			0-8	0-8	SW by S.		8-5	Id., chiefly linear.
	20	0	0	29.930	47.1	54.8		0-0	0-0		WNW.	9-8	Scud : light rain : sky to NE.
	23	0	0	29.937	49.9		0-6	0-6	WSW.	WNW.	6-5	Id. : linear cirri.
Oct. 14	2	0	0	29.915	50.5		0.00	0-4	0-4	W by S.	WSW.	4-0	Loose edged cum. : woolly and lin. cir.
	5	0	0	29.917	49.9			0-5	0-5	WSW.	WSW.	9-8	Cir.-cum.-scud : cir.-str. : cir.-haze.
	20	0	0	29.984	47.2	56.0		0-3	0-3	W by S.	W by N.	9-5	Cirro-cumulous-scud.
	23	0	0	30.001	50.3	46.2	0.000	0-1	0-1	W.	WNW.	0-8	Patches of scud.
Oct. 15	2	0	0	29.989	53.3		0.00	0-5	0-5	WSW.	NW : WSW.	2-5	Loose edged cumuli : cumuli.
	5	0	0	30.000	50.3	58.9		0-3	0-3	WSW.	W by S.	3-0	Loose cum. and cir.-cum.
	20	0	0	29.810	44.6	56.0		0-1	0-1		W.	10-0	Nearly homogeneous scud ?
Oct. 16	20	0	0	29.732	46.3	46.2	0.000	0-4	0-4	SW by S.	W.	10-0	Id.
	23	0	0	29.631	46.9		0.00	0-4	0-4	SW.	W.	10-0	Scud : cumuli to N. : more broken.
Oct. 17	2	0	0	29.503	45.8			0-1	0-1	SW by S.	W : NW.	7-5	Scud to S. : loose cir.-cum. to N. : rain to E.
	5	0	0	29.087	37.5	50.8		0-0	0-0		NW by W.	3-0	Scud on hor. : feathery cirri.
	23	0	0	29.079	39.9	36.2	0.000	0-6	0-6	W by S.	NW by W.	1-5	Loose cum. : cir. : cir.-haze.
Oct. 18	2	0	0	29.050	47.8		0.00	1-0	1-0	NW by N.	NW.	1-5	Id. :
	5	0	0	29.061	39.5	38.0		2-0	2-0	NW by N.		10-0	Hazy clouds : dark to W. : rain.
	20	0	0	29.160	36.8	48.3		0-8	0-8	N by W.	N.	5-0	Thin scud : cum. : cir.-cum. : clearing.
	23	0	0	29.177	40.0	31.3	0.048	3-0	3-0	N.	N.	3-0	Loose cumuli.
Oct. 19	2	0	0	29.198	42.1	36.8	0.00	2-5	2-5	N by W.	N.	6-0	Id.
	5	0	0	29.219	39.8	35.1		0-8	0-8	NNW.		2-0	Id. round hor.
	20	0	0	29.340	29.7	43.2		0-0	0-0		N by W : W.	1-0	Heavy cum. on hor.
	23	0	0	29.377	39.5	24.2	0.000	0-1	0-1	W by S.	N by W : W.	2-0	Towering cum. on E. hor. : loose cum. and cir.-cum.
Oct. 20	2	0	0	29.397	41.7		0.00	0-8	0-8	NW by N.	NW.	2-0	Cumuli.
	5	0	0	29.432	39.5	34.4		0-3	0-3	NNW.		2-0	Id. on horizon.
	20	0	0	29.697	31.7	42.1		0-3	0-3		NW.	0-5	Cumuli on horizon as at 5h.
	23	0	0	29.739	40.4	35.3	0.000	1-0	1-0	NW.	NW.	0-2	Id. : linear cir. to NW.
Oct. 21	2	0	0	29.735	42.4	36.3	0.00	1-0	1-0	NW.	NW.	2-0	Id. : loose cumuli.
	5	0	0	29.725	41.2	36.7		0-1	0-1			9-5	Id. : scud : woolly cirri.

Oct. 21—22. Anemometer fitted up. The indications are in pounds of pressure on the square foot of surface.

Göttingen Mean Time of Observation.		BARO-METER Corrected.		THERMOMETERS.		RAIN GAUGES A. & B.		ANEMOMETER.			STATE OF THE SKY.			
								Pressure.		Direction of Wind.			Quantity of Clouds.	Species of Clouds, &c.
								Max.	Pres.					
d.	h.	m.	in.	°	°	in.	lbs.	lbs.						
				Max.	and Min.									
				Dry.	Wet.									
Oct.	21	20	0	28-963	41-8	40-8	43-4	3-3	1-5	SW by S.	0-10	Rather heavy rain : scud.		
	23	0	28-835	45-8	42-5	35-0	2-0	0-8	W by S.	10-0	Patches of scud : loose cir-cum.			
Oct.	22	2	28-731	47-6	43-1	0-30	2-5	1-5	WSW.	7-0	Loose cum : woolly, linear, &c., cir. : cir.-haze.			
	5	0	28-631	44-8	41-0	48-4	2-5	0-5	SW.	9-8	Scud : hazy clouds : stormy-like.			
						38-4	6-3	1-3	NNW.	9-3	Scud : hazy above ?			
Oct.	23	20	29-080	39-6	36-5	48-8	3-3	3-3	NNW.	2-0	Id. : cir.-strati.			
	23	0	29-120	40-7	35-9	38-9	4-5	2-8	NNW.	2-0	Id., chiefly on horizon.			
Oct.	24	2	29-141	42-2	35-7		4-8	0-5	NW by N.	1-0	Cumuli on hor. : linear cir. to W.			
	5	0	29-157	38-8	34-6		0-8	0-3	SSW.	1-5	Cumuli on horizon : linear cir. to S.			
	20	0	29-237	28-6	27-2	42-3	0-5	0-0	SSW.	10-0	Clouds like ragged curtains : snow to S.			
	23	0	29-236	33-9	31-8	27-0	0-8	0-5	ESE.	10-0	Nearly as at 23 ^h : snow on Cheviot : snow at 3 ^h .			
Oct.	25	2	29-139	36-0	32-7		0-8	0-5	SE by S.	10-0	Id. : scud, &c. : drops of rain.			
	5	0	28-987	35-5	34-5		1-0	0-8		7-5	Loose cum. : cir-cum. : snow on the ground.			
	20	0	28-818	30-6	30-7	37-1	4-8	0-8	SW.	10-0	Snowing.			
Oct.	26	2	28-808	33-5	32-5	27-8	1-5	0-8	SW by S.	10-0	Scud : cirrous haze to S. : sleet.			
	23	0	28-744	37-4	35-6		1-8	1-3	SW by S.	8-0	Id. :			
	5	0	28-778	42-8	39-3		2-5	1-8	WSW.	7-0 ?	Scud : loose cir-cum. : cirri, &c.			
	20	0	29-123	39-5	37-2	43-0	3-0	0-5	SW by W.	9-5	Id. : woolly, &c. cirri : stormy-like.			
	23	0	29-106	43-0	39-2	39-9	2-8	2-3	W by N. v.	9-9	Id. : id. : drops of rain.			
Oct.	27	2	29-135	46-9	40-5		5-8	2-8	NW by W.	10-0	Id. : id. : light rain.			
	5	0	29-169	43-8	39-5		4-3	2-0	NW by N.	6-5	Scud : cirri, &c., indescribable.			
	20	0	29-362	41-7	38-9	47-5	3-8	0-8	NW by N.	3-0	Id. : cum. : varieties of cirri.			
	23	0	29-372	44-4	40-9	38-8	2-0	2-0	NW by N.	8-0	Id. : id. : id.			
Oct.	28	2	29-383	45-8	41-7		0-03	1-0	N.	10-0	Id. : id. :			
	5	0	29-407	42-7	39-5		1-5	0-5	NNW.	2-0	Loose cirro-cumuli.			
	20	0	29-647	35-7	33-4	46-4	2-0	0-3	NE ?	1-0	Cirro strati : linear cirri.			
	23	0	29-682	40-9	37-1	33-9	0-8	0-5	NNW.	7-0	Patches of cum., but chiefly cirri.			
Oct.	29	2	29-677	44-9	38-8		0-00	0-3	NNW.	9-0	Cir-cum-scud. : cir. : cir.-haze : cir.-str.			
	5	0	29-692	40-0	36-9	47-2 ?	0-3	0-0	SW.	10-0	Large loose cirro-cumuli.			
	20	0	29-899	46-9	44-2	53-8	2-0	0-0	NE ?	10-0	Scud : loose cum. : cir-cum. : cir.-haze.			
	23	0	29-909	50-9	47-4	45-3	1-3	0-8	SW by W.	10-0	Scud : rippled-like cir-clouds, &c.			
Oct.	31	2	29-899	49-8	47-6		1-3	0-5	SW by S.	10-0	Id. : var. of cir. : cum. : clouds of various colours.			
	5	0	29-881	49-6	46-6		1-0	1-0	WSW.	7-0	Smoky scud : scud : varieties of cir.			
	20	0	29-929	48-4	46-6	53-3	2-8	0-3	SW by W.	6-5	Loose cir-cum. : cir.-str. : id.			
	23	0	29-962	54-0	50-7	47-2	0-5	0-3	WSW.	6-0	Id. :			
Nov.	1	2	29-960	56-9	53-0		0-00	0-3	WSW ?	9-0	Id.			
	5	0	29-953	55-9	53-0		0-0	0-0	N by E.					

Oct. 25^d 9^h. Maximum wind 2-5 lbs.
Oct. 31^d 9^h. Maximum wind 2-8 lbs.

Göttingen Mean Time of Observation.		BARO- METER Corrected.		THERMOMETERS.			RAIN GAUGES A. & B.		ANEMOMETER.			STATE OF THE SKY.	
				Dry.	Wet.	Max. and Min.	in.	Pressure.		Direction of Wind.	Clouds moving from	Quan- tity of Clouds.	Species of Clouds, &c.
								lbs.	Pres.				
Nov. 1	20 0	29.984	47.4	46.8	57.6	0.000	0.3	0.3	NE.	ENE.	0-10	Thin scud : cirri.	
Nov. 2	2 0	29.988	48.3	46.3	46.0	0.000	0.3	0.0		ESE.	10.0	Scud.	
Nov. 2	2 0	29.968	48.4	45.3		0.00	0.3	0.1		SE by E.	9.7	Id. : sky on ESE, hor.	
Nov. 2	5 0	29.955	45.5	42.7			0.3	0.3	E by S.	ESE.	10.0	Id. : cirri.	
Nov. 3	2 0	29.897	42.5	40.1	49.0	0.000	0.3	0.0		E.	10.0	Scud.	
Nov. 3	2 0	29.900	44.9	41.5	41.2	0.000	0.3	0.0	E by N.	E.	6.5	Cum. : large loose cir.-cum. : drops of rain.	
Nov. 3	2 0	29.899	47.5	41.7		0.00	1.0	0.5	E by N.	E by N.	7.5	Loose cumuli.	
Nov. 3	5 0	29.916	44.1	40.4			1.0	0.3	NE by E.	E.	3.0	Scud : sky quite gray : showers around.	
Nov. 4	2 0	30.066	38.5	35.9	48.5	0.078	1.3	0.0		ENE.	6.0	Cir.-cum.-scud : cum. : nimbi.	
Nov. 4	2 0	30.121	40.2	33.2	36.7	0.05	0.5	0.0	NE by E.	ENE.	2.0	Patches of scud : piles of cum. : nimbi : showers.	
Nov. 4	2 0	30.150	41.8	38.9			1.3	0.5	NE by E.	ENE.	3.5	Piles of cum. and nimbi : loose cir.-cum : showers of hail	
Nov. 4	5 0	30.177	40.5	38.7			3.0	0.5	NE by E.	E.	7.5	Masses of loose cum. and nimbi : showers. [and rain.	
Nov. 5	2 0	30.225	40.5	38.3	44.2	0.040	1.0	0.5	N by E.	NNE.	9.5	Scud : loose cir.-cum. : fine cir.-cum. : shower to N.	
Nov. 5	2 0	30.226	42.4	39.8	32.0	0.02	1.5	0.5	N by E.	NE.	7.0	Nimbi, &c. : showers : rainbow.	
Nov. 5	2 0	30.177	43.5	41.3			2.3	1.0	N by E.	NNE.	9.5	Scud and nimbi : cir.-cum. : showers.	
Nov. 5	5 0	30.161	42.8	40.4	45.1	0.042	2.8	0.5	NNE.	NE by N.	9.0	Scud, cum., and nimbi : showers.	
Nov. 6	20 0	30.120	39.4	37.5	36.8	0.12	1.0	0.5	N by W.	NNE.	9.7	Cir.-cum.-scud. : rain to S ?	
Nov. 6	23 0	30.108	41.9	39.3	37.7		0.5	0.3	NNW.	NNE.	9.7	Id.	
Nov. 7	2 0	30.085	42.9	38.6			0.5	0.3		SSW.	10.0	Id., thicker.	
Nov. 7	5 0	30.047	40.5	37.5			0.3	0.0			8.2	Id. : snow on Cheviot.	
Nov. 8	20 0	29.814	39.5	38.0	44.2	0.000	1.0	0.5	SW by S.	WNW.	8.0 ?	Loose cirro-cum. : cir.-str., &c.	
Nov. 8	23 0	29.781	43.9	42.0	35.8	0.000	0.8	0.5	SW by S.	WSW : NNE.	9.5	Cir.-cum. : cir.-haze, &c.	
Nov. 8	2 0	29.716	46.8	43.1			1.0	0.5	WSW.	WSW : NNE.	7.0	Cumuli : cirri : cir.-haze.	
Nov. 8	5 0	29.635	44.8	41.8			1.3	1.0	SW by S.	WSW.	5.0	Scud : cum. : cir.-str. : hazy.	
Nov. 9	20 0	29.064	44.1	42.5	47.9	0.117	8.8	4.5	SW by S.	SW.	10.0	Light rain : scud ?	
Nov. 9	23 0	29.007	48.6	46.8	38.5	0.25	5.3	3.0	SW by S.	SW.	10.0	Id. : id.	
Nov. 9	2 0	28.985	50.2	48.6			4.8	1.8	SW by S.	SW.	10.0	Id. : id.	
Nov. 9	5 0	29.018	48.4	44.6			2.8	1.0	SW by S.	SW.	9.5	Scud : hazy.	
Nov. 10	20 0	29.344	33.6	32.9	51.1	0.005	0.8	0.0		W by S.	0.5	Linear cirri : hoar frost.	
Nov. 10	23 0	29.393	34.1	33.6	31.2	0.00	0.3	0.0	NE.	SW.	3.5	Cirro-cumuli : linear cirri.	
Nov. 10	2 0	29.382	41.2	38.7			0.0	0.0			10.0	Scud : cirrous haze.	
Nov. 10	5 0	29.362	39.7	34.5			0.0	0.3			10.0	Thick cirrous haze.	
Nov. 11	20 0	28.938	42.5	41.7	43.4	0.560	2.3	0.0	ESE.	SE by E.	10.0	Very thick and dark : light rain.	
Nov. 11	23 0	28.886	42.0	40.9	31.4	0.45	0.5	0.3		SE by E.	10.0	Scud.	
Nov. 11	2 0	28.800	42.8	41.8			0.5	0.0			10.0	Id., breaking : light shower.	
Nov. 11	5 0	28.738	42.8	41.7			0.5	0.0	SE by E.		10.0	Nearly homogeneous : slightly foggy.	

Göttingen Mean Time of Observation.	BARO- METER Corrected.		THERMOMETERS.			RAIN GAUGES A. & B.		ANEMOMETER.		STATE OF THE SKY.			
	d.	m.	in.	Dry.	Wet.	Max. and Min.	in.	Pressure.		Direction of Wind.	Clouds moving from	Quan- tity of Clouds.	Species of Clouds, &c.
								Max.	Pres.				
Nov. 11	20	0	28.701	40.7	40.2	43.4	0.005	0.0	0.0	WNW.	WNW.	0-10.	Scud ? light mist.
	23	0	28.762	43.8	42.7	39.6	0.01	0.0	0.0	SW by W.	W.	10.0	Cir.-cumulous-scud ?
Nov. 12	2	0	28.794	49.6	47.2	50.0	0.01	0.8	0.5	SW	W.	9.7	Scud : cir.-str. : cir.-cum. : cir.-haze.
	5	0	28.854	47.6	46.2	39.0		1.3	0.3	SW.	W.	10.0	Id. : cir.-cum.
Nov. 13	20	0	29.483	35.6	33.9	46.7	0.118	1.8	0.0	WNW.	WNW.	6.0	Cum. to NE. : loose cir.-cum. : cir.-haze.
	23	0	29.579	37.3	34.2	34.2	0.11	0.3	0.0	N.	WNW.	3.5	Id. : id. : snow on Cheviot.
Nov. 14	2	0	29.618	38.8	34.3			0.5	0.5			0.5	Id. E. : linear cirri.
	5	0	29.650	33.2	31.8			0.5	0.0			3.0	Id. id. : lunar corona.
	20	0	29.650	23.5	23.5 ?	39.1		0.3	0.0	ENE ? 0.	ENE ? 0.	2.5	Scud : cirro-cumuli.
	23	0	29.674	30.1	29.7 ?	21.3	0.000	0.0	0.0	ENE : W.	ENE : W.	4.0	Id. : id. : snowing to N. and E.
Nov. 15	2	0	29.653	37.8	33.4		0.00	0.3	0.5	NNE.	ENE : W.	6.5	Id. : cumuli : var. of cirri : mealy snow since 23 ^h .
	5	0	29.664	36.8	35.1			1.0	0.0		ENE : WSW ?	10.0	Id. : varieties of cirri.
	20	0	29.768	37.2	34.8	38.4		1.3	0.3	NE by E.	ENE.	10.0	Scud.
	23	0	29.813	38.3	34.5	35.0	0.025	0.8	0.5	NE.	ENE.	9.7	Id. : cirri : cir.-haze.
Nov. 16	2	0	29.839	39.1	34.3		0.00	3.3	1.3	NE by E.	ENE.	9.5	Id. : id. : id.
	5	0	29.883	38.4	33.3			1.8	0.5	NE by E.	ENE.	10.0	Id. : id. : id.
	20	0	30.159	35.8	34.4	39.3		1.3	0.0			10.0	Indefinable mass.
	23	0	30.218	38.5	36.4	34.9	0.000	0.0	0.0	E.	E.	9.9	Id., breaking.
Nov. 17	2	0	30.234	42.5	37.5		0.00	0.0	0.0	ESE : N ?	ESE : N ?	9.7	Loose cumuli : cirri.
	5	0	30.249	40.2	36.1			0.3	0.0			10.0	As at 23 ^h .
	20	0	30.190	37.7	35.1	43.0		0.8	0.5	SSW.	WNW.	7.0	Cir.-cum. : cir.-str. : cir.-haze.
	23	0	30.194	40.5	37.5	34.7	0.000	1.8	0.5	SW by W.	WSW.	9.0	Scud : cir.-cum. : cir. : cir.-haze.
Nov. 18	2	0	30.170	43.1	40.1		0.00	1.0	0.8	SW by W.	WSW : NW.	9.0	Scud 3 : mottled cir. : cir.-haze.
	5	0	30.155	41.3	39.3			1.5	0.0		WSW.	9.7	Scud : cir.-haze.
	20	0	29.682	33.7	33.6	43.3		0.3	0.0	SW by S.	SW : WNW.	10.0	Thick mist : sprinkling of snow fallen.
	23	0	29.613	36.9	36.5	31.4	0.203	0.0	0.0	SW by W.	SW : WNW.	10.0	Hazy scud.
Nov. 19	2	0	29.530	48.8	47.4		0.18	1.0	0.5			2.5	Loose cumuli : mottled cirri, &c.
	5	0	29.492	49.3	47.3	50.5		1.0	0.3	SW by W.	SW : WNW.	9.9	Heavy black scud and cum. : wild sky.
Nov. 20	20	0	29.704	33.2	32.5	42.2		1.3	0.3	NNW.	NNE.	3.0	Scud : towering cum. to NE. : clearing.
	23	0	29.733	34.7	32.8	30.8	0.047	0.5	0.3	NNW.	NNE.	3.0	Loose cum. : cum. : cir.-haze : rain to SE.
Nov. 21	2	0	29.695	36.5	34.4		0.02	0.5	0.3	NNW.	NE ?	5.0 ?	Towering cum. on E. hor., but chiefly cir.-haze.
	5	0	29.672	34.3	32.8			0.3	0.0			10.0	Scud, and as at 2 ^h .
	20	0	29.232	33.1	32.6	37.3		0.3	0.0	SSE.	SSE.	10.0	Light fall of snow.
	23	0	29.164	34.6	33.6	34.1	0.070	0.3	0.3	S by E.	SSW.	10.0	Scud : cir.-haze : flakes of snow.
Nov. 22	2	0	29.091	35.3	33.6		0.02	0.5	0.3			10.0	Id. : id. : id.
	5	0	29.054	34.3	33.8			0.3	0.0			10.0	Homogeneous gray : id.

Göttingen Mean Time of Observation.	BARO- METER Corrected		THERMOMETERS.		RAIN GAUGES A. & B.		ANEMOMETER.		STATE OF THE SKY.		
	d.	h. m.	in.	Dry.	Wet.	Max. and Min.	Pressure. Max. Pres.	Direction of Wind.	Clouds moving from	Quan- tity of Clouds.	Species of Clouds, &c.
Nov. 22	20	0	29.078	33.4	32.3	35.9	0.5	WSW.	WNW.	0-10	Scud : cir.-clouds : sky to S.
	23	0	29.080	35.2	33.3	31.2	0.8	SW.	W by N.	9.0	Cir.-strati on SE. hor. : cirri to NE.
Nov. 23	2	0	29.054	38.5	36.1		0.5	WSW.	WNW.	1.0	Cumuli : cirri.
	5	0	29.044	34.9	33.8		0.3		WNW.	2-5	Scud : cirro-strati to NE.
	20	0	28.701	36.5	37.5	38.5	0.3	ESE.	ESE.	10.0	Scud : cirrous haze : light rain.
	23	0	28.663	39.7	38.5	23.5	0.5	ESE.	ESE.	10.0	Id. : id.
Nov. 24	2	0	28.600	41.4	40.0		1.0	E.	ESE.	10.0	Id. : id.
	5	0	28.562	40.5	39.6		1.3	E by N.	ESE.	10.0	Id.
	20	0	28.553	42.3	40.9	42.1	1.0	ESE.	SE ?	10.0	Scud : cirrous clouds : breaking.
	23	0	28.587	43.4	41.8	38.3	0.5	ESE ?	SE.	9.7	Scud : cum. : cir.-str. : sky to SE.
Nov. 25	2	0	28.600	43.2	41.3		0.5		SE by E.	9.7	Scud : haze above : sky to N.
	5	0	28.607	43.0	41.3		1.0	ESE.	SE by E.	10.0	
	20	0	28.675	37.4	36.5	44.1	0.0		SE by E.	9.9	Scud : haze above : red to E. : rain lately.
	23	0	28.700	39.0	38.5	35.1	0.0			8.0	Scud : clearing off.
Nov. 26	2	0	28.710	40.2	39.5		0.0			10.0	Hazy.
	5	0	28.731	39.9	39.3	41.1	0.0			10.0	Dense scud.
	20	0	28.696	44.8	42.8	35.5	2.0	ESE.	SE.	10.0	Scud : light rain.
	23	0	28.614	45.3	44.0		1.8	SE by S.	SSE.	9.9	Id. : cir.-clouds : light rain.
Nov. 28	2	0	28.565	46.8	45.6		1.0	SE.	SSE.	10.0	Id. : id.
	5	0	28.559	49.0	47.6		2.3	SSE.	S.	10.0	Id. : id.
	20	0	28.955	41.6	40.3	49.2	1.8	SSW.	SW.	6.0	Scud : loose cumuli.
	23	0	29.019	44.1	42.1	33.3	1.3	S.	SW.	7.0	Id. : sky to E.
Nov. 29	2	0	29.068	47.0	43.4		1.8	SSW.	SW.	8.5	Id. : heavy cum. : cir. clouds : rain.
	5	0	29.118	42.8	40.5		1.8	S by W.	SW.	6.0	Id. : sky hazy.
	20	0	29.330	37.8	37.4	48.2	1.3		SW.	4.0	Scud : nimbi : cum.
Dec. 3	2	0				36.9 ?					
	5	0	29.977	47.1	44.6	55.9	9.0	SW.	W by S.	1.5	Scud.
Dec. 4	20	0	29.830	49.7	47.1	50.5	6.0	SW.	W by S.	10.0	Scud : clouds breaking.
	23	0	29.879	49.6	48.4	46.6	2.5	SW by W.	W by S : SW.	7.5	Id. : mottled cirri.
Dec. 5	2	0	29.904	50.1	48.6		1.3	SW.	WSW.	9.9	Id.
	5	0	29.903	48.9	47.6		0.8	SW.	WSW.	9.9	Id.
	20	0	29.951	44.8	44.4	50.8	0.8			10.0	Foggy : rain lately.
	23	0	29.982	45.6	45.2	43.2	0.258			10.0	Thick fog : clearing off.
Dec. 6	2	0	29.959	47.9	46.5		0.0			10.0	Id. : id.
	5	0	29.941	44.3	44.2		0.0		E ?	7.0	Scud : flocculent cir.-cum. : mists rising.

Nov. 24^a 20^b. The mercury, when the maximum temperature was read, had attained the index, but the quantity registered cannot be far from the truth.
 Nov. 27^a 20^b. Maximum and minimum thermometers omitted to be read.
 Nov. 28^a 20^b. It is doubtful whether this be the minimum of 27^a or 28^a, as the instrument was probably not set on 27^a.
 Dec. 3^a 5^a. The maximum and minimum read at 5^b are the max. and min. since Nov. 28^a 20^b.

Göttingen Mean Time of Observation.		BARO-METER Corrected.	THERMOMETERS.			RAIN GAUGES A. & B.	ANEMOMETER.			STATE OF THE SKY.	
			Dry.	Wet.	Max. and Min.		Pressure. Max. Pres.	Direction of Wind.	Clouds moving from	Quantity of Clouds.	Species of Clouds, &c.
Dec. 6	20 0	29.957	45.4	43.6	47.5	0.017	0.8	0.3	SW by S.	0-10.	Homogeneous.
Dec. 7	2 0	29.987	45.6	43.5	42.4	0.01	1.0	0.5	SW by S.	9-9	Scud: clouds breaking.
Dec. 8	2 0	29.973	46.4	44.1	44.1	0.00	1.5	0.3	SW by S.	9-5	Id.: loose cumuli: cir.: cir.-haze.
Dec. 9	2 0	29.968	44.7	43.1	43.1	0.00	1.8	0.5	SW by S.	8-0	Stratous scud: cir.-cum. clouds.
Dec. 10	2 0	30.091	45.8	44.3	47.0	0.000	3.5	0.5	SW by W.	9-5	Scud: cirrous clouds.
Dec. 11	2 0	30.127	47.0	45.7	44.0	0.00	0.8	1.0	SW by S.	9-5	Cirro-cumulous scud.
Dec. 12	2 0	30.146	48.4	46.6	46.6	0.00	0.8	0.3	SW by W.	10-0	Id.
Dec. 13	2 0	30.176	47.5	46.4	46.4	0.00	0.5	0.0	W.	10-0	Id.
Dec. 14	2 0	30.238	43.2	42.5	48.5	0.000	0.3	0.0		10-0	Homogeneous gray.
Dec. 15	2 0	30.263	42.7	42.7	42.5	0.00	0.0	0.0	S.	10-0	Scotch mist.
Dec. 16	2 0	30.224	44.9	44.3	44.3	0.00	0.0	0.0	SSE?	9-9	Id.: scud: cum.: breaking.
Dec. 17	2 0	30.204	44.3	43.7	44.3	0.00	0.0	0.0	SSE?	10-0	Id.: id.: id.
Dec. 18	2 0	30.023	41.2	40.8	45.4	0.000	0.3	0.0	E? S?	10-0	Thick mist.
Dec. 19	2 0	29.987	41.5	41.1	40.2	0.00	0.0	0.0	SSE.	9-9	Id.: scud: cir.: breaking.
Dec. 20	2 0	29.943	44.0	43.3	44.8	0.00	0.3	0.0		10-0	Mist: light rain: scud.
Dec. 21	2 0	29.920	43.6	42.6	44.8	0.00	0.3	0.0		9-7	
Dec. 22	2 0	29.348	43.3	42.4	43.4	0.138	1.5	0.5	S.	9-7	Dark: light rain: sky to SSE.
Dec. 23	2 0	29.323	46.6	45.6	33.8	0.10	1.3	0.8	SW by S.	10-0	Scud: lightest rain: hazy sky.
Dec. 24	2 0	29.321	51.8	51.0	51.0	0.10	1.8	0.8	SW by S.	10-0	Scud: nimbi: light rain.
Dec. 25	2 0	29.362	53.5	53.5	31.4	0.00	1.8	1.3	SW.	10-0	Id.: light rain.
Dec. 26	2 0	29.436	55.5	53.5	55.6	0.332	3.3	2.8	SW by S.	10-0	Scud: light rain.
Dec. 27	2 0	29.492	55.5	53.5	51.4	0.20	3.3	2.8	SW by S.	10-0	Id.: id.
Dec. 28	2 0	29.502	55.1	54.3	44.8	0.075	3.0	1.0	SSW.	10-0	Id.: rain.
Dec. 29	2 0	29.507	55.2	54.0	44.8	0.02	2.5	1.3	SSW?	10-0	Id.: id.
Dec. 30	2 0	29.698	51.1	48.4	56.1	0.075	4.8	0.5	SSW.	9-7	Scud: cirri to SE.
Dec. 31	2 0	29.760	50.7	47.8	49.7	0.02	3.3	0.5	SW by S.	9-0	Cirrous scud.
Dec. 1	2 0	29.739	50.3	47.6	47.6	0.00	1.3	0.5	SW by S.	9-0	Cirrous clouds.
Dec. 2	2 0	29.730	46.4	44.9	44.9	0.00	0.5	0.0	W.	10-0	Thick cirrous clouds.
Dec. 3	2 0	29.613	53.1	49.5	55.5	0.017	3.8	2.5	SSW.	10-0	Drops of rain: patch of red to SE.
Dec. 4	2 0	29.638	51.4	49.8	45.3	0.00	3.8	1.3	SSW.	10-0	Scud: light rain.
Dec. 5	2 0	29.625	55.0	51.6	48.5	0.00	1.5	1.5	SSW.	10-0	Id.
Dec. 6	2 0	29.594	54.9	50.4	50.4	0.00	4.8	3.3	SSW.	2-5	Id.: a few cirrous clouds: hazy.
Dec. 7	2 0	29.617	47.8	46.9	56.2	0.022	4.5	0.5	SW?	8-0	Cum.-str. and cir.-str. on hor.: cirri and cir.-haze.
Dec. 8	2 0	29.630	48.8	47.9	47.3	0.00	0.5	0.0	SW by W.	10-0	Scud: misty drizzle.
Dec. 9	2 0	29.582	50.5	48.9	48.9	0.00	0.8	0.3	SW by S.	9-0	Id.: cum. to E.: cirrous clouds above.
Dec. 10	2 0	29.528	50.0	48.5	48.5	0.00	0.8	0.3	SSW.	9-9	Id.: drops of rain as during the day.

Dec. 13^d 8h. Maximum pressure of wind 3.2.

Göttingen Mean Time of Observation.	BARO- METER Corrected.		THERMOMETERS.			RAIN GAUGES A. & B.	ANEMOMETER.			STATE OF THE SKY.			
	d.	h. m.	in.	Dry.	Wet.		Max. and Min.	Pressure.		Direction of Wind.	Clouds moving from	Quan- tity of Clouds.	Species of Clouds, &c.
								Max.	Pres.				
Dec. 16	20	0	29.381	40.7	39.2	50.6	in.	lbs.	lbs.	lbs.	0-10.		
	23	0	29.497	41.3	38.9	39.6	0.158	4.5	1.8	SW by W.	1.0	Scud : nimbi : cum. : lunar rainbow.	
Dec. 17	2	0	29.586	43.7	40.7	44.6	0.07	2.0	1.0	SW by W.	1.0	Loose cumuli.	
	5	0	29.628	43.3	40.3	44.6		2.3	0.8	SW by W.	1.5	Cirrous scud to W.	
						40.4?		2.5	2.5	SW.	7.0	Loose cumuli.	
Dec. 18	20	0	30.127	40.4	38.6	47.5	0.046	2.8	0.3	SW?	2.0	Cirrous clouds and haze.	
	23	0	30.162	42.6	41.1	38.9	0.02	1.5	0.5	SSW.	5.0	Scud : mottled, curled, and linear cirri.	
Dec. 19	2	0	30.097	46.3	42.8	42.9		1.8	0.8	SW by W.	7.0	Loose cum. : mottled cirri.	
	5	0	30.074	42.9	41.0	41.0		1.8	2.0	SW.	10.0	Cirrous clouds.	
	20	0	29.981	48.8	45.0	51.3	0.014	3.5	0.5	SW by W.	8.0?	Scud : linear cirri : lunar corona.	
	23	0	30.028	49.4	45.0	41.6?	0.00	1.5	1.0	W.	9.7	Id. : varieties of cirri.	
Dec. 20	2	0	29.997	49.3	44.9	44.6		1.8	1.0	W.	6.0	Cirrous scud.	
	5	0	29.973	47.9	44.6	44.6		1.5	0.5	WSW.	10.0	Thick scud : cirrous clouds.	
	20	0	29.979	48.0	46.6	51.1	0.002	3.3	0.0	WNW.	3.0	Cirrous cir.-cum. : fine cirri.	
	23	0	29.993	47.4	44.9	44.5	0.00	0.8	0.5	SSW.	8.0	Cir.-cum. : cymoid and other cirri.	
Dec. 21	2	0	29.963	50.5	47.4	49.2		1.5	0.5	SW.	10.0	Cirrous clouds : scud to S.	
	5	0	29.895	51.3	49.6	49.6		1.8	1.3	SW.	9.0	Scud : cirrous clouds.	
	20	0	29.606	49.4	46.4	52.8	0.000	4.5	2.0	SW.	10.0	Heavy scud, &c.	
	23	0	29.526	49.2	47.1	49.2	0.00	2.8	2.8	SW.	9.9	Smoky scud : cirrous clouds.	
Dec. 22	2	0	29.447	50.5	47.4	45.1		7.0	3.0	SW.	1.5	Scud : loose cumuli to E.	
	5	0	29.404	47.9	45.1	45.1		3.5	1.5	SW.	10.0	Id. : light rain.	
	20	0	29.139	37.1	34.4	48.5?	0.200	4.5	2.0	WSW.	1.0	Scud : cirro-strati : sky covering : rain.	
	23	0	29.137	36.2	34.4	33.9	0.10	1.8	1.5	SW by W.	0.8	Id. : cir.-str. : cirri : rain.	
Dec. 23	2	0	29.090	38.1	35.2	33.9		3.8	1.0	SW by W.	1.5	Cumuli.	
	5	0	29.035	37.3	34.5	33.4		3.0	3.0	SW.	8.5	Loose-edged cumuli.	
	20	0	29.243	35.3	33.4	38.9	0.014	4.0	0.0	W?	8.0	Scud : cirrous clouds.	
	23	0	29.307	35.7	32.9	34.1	0.00	1.8	0.0	W by S.	0.2	Cumuli on NE. and SE. hor.	
Dec. 24	2	0	29.317	38.4	35.2	39.1?		0.8	0.3	SW by W.	0.2	Id.	
	5	0	29.367	36.0	33.9	32.3		1.0	0.3	SW by W.	2.0	Semifluid cirro-cumuli.	
	20	0	28.764	48.0	45.3	51.3	0.076	7.8	3.5	SW.	8.0	Thin watery haze : lunar halo : light rain.	
	23	0	28.785	47.4	45.3	45.6	0.03	6.8	2.3	SW.	5.0	Cirrous scud : woolly cirri : rainbow : rain.	
Dec. 26	2	0	28.825	42.4	40.1	38.4		2.5	1.3	WSW.	9.7	Homogeneous scud : cir. clouds : light rain.	
	5	0	28.856	40.6	38.4	38.4		1.5	0.5	SW.	5.0	Loose cirro-cumuli : varieties of cirri.	
	20	0	28.979	31.3	30.9	48.3	0.000	1.8	0.0	SW.	1.0	Cirrous clouds.	
	23	0	29.064	32.9	32.3	29.2	0.00	0.3	0.3	SW.	0.8	Mixed and linear cirri : cum. to SE.	
Dec. 27	2	0	29.095	37.9	35.3	33.0		0.3	0.5	SW by S.	1.0	Scud : cirri.	
	5	0	29.165	33.6	33.0	33.0		0.5	0.0	W.	1.5	Scud : loose cumuli.	

Göttingen Mean Time of Observation.		BARO-METER Corrected.		THERMOMETERS.			RAIN GAUGES A. & B.		ANEMOMETER.		STATE OF THE SKY.	
				Dry.	Wet.	Max. and Min.	Max.	Pres.	Direction of Wind.	Clouds moving from	Quantity of Clouds.	Species of Clouds, &c.
Dec. 27	0	in.	°	°	in.	lbs.	lbs.					
	23	29.587	33.5	36.9	0.029	0.8	0.0					Cirrous clouds.
Dec. 28	0	29.674	37.5	34.9	0.01	0.5	0.3	W.				Scud to SE.
	2	29.720	39.3	36.7		0.3	0.3	SW by W.				Linear cirri : cum. to SE.
	5	29.731	36.9	35.4		0.5	0.3	SW.				Linear cirri and cirrous haze.
	20	29.449	49.1	47.6		3.5	2.3	SW.	W.			Scud : light rain.
Dec. 29	0	29.492	49.1	33.3	0.312	3.0	2.5	WNW.	W.			Id. : heavy rain to E.
	2	29.551	48.3	44.7	0.22	4.5	3.3	W. v.	W : W by N.			Patches of scud : linear cirri.
	5	29.678	45.4	41.8		2.5	1.0	W. v.	W by N.			Scud and cirrous clouds.
	20	29.543	53.5	51.3		3.3	2.3	SW by W.	W by S.			Scud.
Dec. 30	0	29.529	55.0	52.5	0.291	4.3	2.5	SW by W.	W by S.			Id.
	2	29.537	57.7	53.5	0.06	7.0	3.5	SW by W.	W.			Id. : linear cirri, &c.
	5	29.552	56.7	53.3		5.5	4.0	WSW. v.	W.			Id. : id.
	20	29.436	54.1	51.4		6.8	5.0	SW by W.	W.			Scud.
Dec. 31	0	29.464	53.5	49.0	0.000	6.8	5.5	SW by W.	W.			Loose cum. : woolly cir.-cum. : rainbow.
	2	29.563	46.7	41.8	0.00	6.8	2.0	W. v.	W by N.			Woolly cirri, &c. : cumuli to N.
	5	29.672	42.6	38.5	0.007	2.5	1.3	WNW.	WNW.			Varieties of cirri : id. NE. and SW.
				28.4	0.01							4.0

Dec. 31^a 5^b. The rain noted is the quantity read Jan. 1^a 1843.

TERM-DAY
AND
EXTRA METEOROLOGICAL
OBSERVATIONS.

1841 AND 1842.

Göttingen Mean Time of Observation.		BARO-METER corrected.	THERMOMETERS.		STATE OF THE SKY.	Göttingen Mean Time of Observation.		BARO-METER corrected.	THERMOMETERS.		STATE OF THE SKY.
d.	h.		Dry.	Wet.		d.	h.		Dry.	Wet.	
July 21	10	29.305	56.5	53.7		Sept. 22	23	29.390	55.0	53.6	Overcast: calm.
	11	29.311	55.6	53.2		Sept. 23	0	29.386	56.1	54.1	Id.: id.
	12	29.320	55.3	52.6			1	29.356	56.9	54.7	Id.: id.
	13	29.326	54.7	52.1			2	29.359	56.7	55.7	Scud: cum.: light rain.
	14	29.332	54.7	49.8			3	29.384	59.0	55.8	Cloudy: gleams of sunshine.
	15	29.330	52.7	49.0			4	29.372	58.8	56.7	Cloudy to N.: cir.: sky to S.
	16	29.341	52.5	48.8			5	29.370	58.3	56.0	Cum: cir.: clearer.
	17	29.341	52.9	48.6			6	29.368	56.9	54.6	Id.: sky rather open.
	18	29.342	53.2	48.8			7	29.369	55.6	54.2	Overcast: cumuli.
	19	29.369	53.6	49.1			8	29.386	53.4	52.1	Id.: id.
	20	29.349	54.4	49.7			9	29.388	53.0	51.7	Id.: id.
	21	29.383	54.2	50.1			10	29.397	51.3	50.7	Open sky.
	22	29.402	53.1	50.3							
	23	29.401	53.7	50.6							
July 22	0	29.430	54.7	51.0		Oct. 20	10	28.873	40.2	38.8	Overcast: light rain.
	1	29.439	55.1	51.2			11	28.953	37.0	35.5	Rain: wind.
	2	29.465	56.5	52.4			12	28.998	34.6	33.7	Heavy rain: wind.
	3	29.478	55.9	52.3			13	29.118	35.9	33.6	Light showers of sleet: windy.
	4	29.486	56.6	52.1			14	29.206	36.0	34.1	Cloudy: fair: wind abating.
	5	29.510	56.2	52.0			15	29.258	35.6	33.5	Id.: id.: wind rising.
	6	29.484	55.9	51.5			16	29.285	35.0	32.4	Clear: light breeze.
	7	29.532	55.2	51.1			17	29.361	33.4	30.8	Id.: id.
	8	29.568	53.8	50.7			18	29.374	33.2	30.3	Id.: id.
	9	29.548	53.1	49.9	Light rain.		19	29.441	32.7	29.9	Id.
							20	29.456	33.7	31.1	Cumuli.
							21	29.497	34.7	31.8	Clear.
							22	29.524	35.8	32.7	Id.: fresh breeze.
							23	29.561	37.2	34.0	Clear.
Aug. 27	10	29.864	58.6	56.4	Cloudy: heavy cumuli.	Oct. 21	0	29.568	38.0	33.6	Id.
	11	29.847	58.8	56.7	Cloudy: cumuli: a gale of wind.		1	29.587	39.6	36.0	Id.: calm.
	12	29.821	58.1	55.8	Cum.: cir.-str.: high wind.		2	29.628	41.0	37.0	Id.: id.
	13	29.779	58.3	56.0			3	29.608	41.7	37.5	Cum.: cir.: calm.
	14	29.780	58.8	56.1	Id.: id.: id.		4	29.607	40.5	37.0	Many cum.: cirri.
	15	29.793	58.4	56.0			5	29.682	39.6	36.8	Cir.-str.
	16	29.774	58.8	56.2	Overcast: drops of rain.		6	29.703	38.8	36.5	Nearly overcast: cir.-str.
	17	29.812	57.3	55.8	Id.: id.: wind.		7	29.737	37.9	35.7	Clouds on hor.: sky in zen.
	18	29.826	57.0	56.0	Id.: wind abated.		8	29.761	37.5	35.5	Id.: id.
	19	29.808	57.6	56.4	Id.: light rain: clearing to E.		9	29.769	36.5	34.8	Clear.
	20	29.845	58.2	56.8	Id.: id.: id.						
	21	29.853	60.1	57.1	Clear: sunshine.						
	22	29.833	61.8	56.5	Cum.: cir.-str.: fine.						
	23	29.861	62.1	57.3	Overcast: cum.: light wind.	Nov. 26	10	29.613	29.6	30.1	Hazy: lunar halo.
Aug. 28	0	29.877	63.2	58.1	Clearing: cum. on hor.		11	29.618	30.2	30.6	Id.: halo less distinct.
	1	29.887	64.3	58.1	Scattered cum: light breeze.		12	29.600	31.1	30.9	Overcast.
	2	29.833	64.2	56.4	Id.: id.		13	29.595	31.8	31.5	Id.
	3	29.875	65.1	57.1	Clearing: id.		14	29.580	32.4	31.8	Id.: calm: light snow.
	4	29.850	65.3	56.2	Cum.: fresh breeze.		15	29.560	32.5	31.8	Id.: id.: snow.
	5	29.846	64.0	56.6	Id.: id.		16	29.531	32.6	31.7	Id.: id.: id.
	6	29.884	63.4	55.8	Id.: cir.: scud.: calm.		17	29.516	32.9	31.9	Id.: id.: id.
	7	29.906	62.0	56.4	Id.: id.: cir.-haze.		18	29.512	33.6	32.0	Id.: id.: id.
	8	29.892	59.2	56.8	Much overcast: calm.		19	29.499	33.6	32.6	Overcast: calm.
	9	29.887	58.8	56.3	Id.: id.		20	29.500	34.1	33.1	Id.
							21	29.508	34.5	33.1	Id.: snow.
							22	29.496	34.7	33.4	Id.
							23	29.494	35.5	33.8	Id.
Sept. 22	11	29.466	51.1	50.1	Rain: calm.	Nov. 27	0	29.493	35.9	34.2	Id.
	12	29.432	51.2	50.2	Fair: cloudy: light breeze.		1	29.483	36.9	34.9	Id.
	13	29.426	51.8	50.7	Id.: id.: id.		2	29.476	36.8	34.7	Id.
	14	29.420	51.9	50.6	Overcast: calm.		3	29.463	36.7	34.7	Id.
	15	29.418	51.9	50.5	Id.: id.		4	29.453	36.7	34.7	Id.
	16	29.350	50.0	48.9	Id.: id.		5	29.455	36.7	35.2	Id.
	17	29.382	50.5	49.6	Id.		6	29.470	36.5	35.4	Id.: light rain.
	18	29.401	51.0	50.1	Id.		7	29.459	36.7	35.8	Id.: id.
	19	29.399	51.3	50.0	Id.		8	29.460	37.5	36.5	Id.: thick mist.
	20	29.396	51.6	50.4	Id.		9	29.448	38.1	37.0	Id.: light rain.
	21	29.396	52.6	51.3	Id.						
	22	29.393	53.5	52.1	Id.						

TERM-DAY AND EXTRA METEOROLOGICAL OBSERVATIONS, DECEMBER 22. 1841—APRIL 21. 1842. 111

Göttingen Mean Time of Observation.	BARO- METER corrected.	THERMOME- TERS.		STATE OF THE SKY.	Göttingen Mean Time of Observation.	BARO- METER corrected.	THERMOME- TERS.		STATE OF THE SKY.	
		Dry.	Wet.				Dry.	Wet.		
Dec. 22	d. h. in.	°	°		Feb. 25	d. h. in.	°	°		
10	29-551	22-3	21-8	Clear : a few cirri.	22	28-876	36-9	35-4	Overcast : snow.	
11	29-538	21-7	20-5	Id. : id.	23	28-895	34-5	33-8	Clearing : wind rising.	
12	29-530	20-5	19-9	Id. : id. : cum.	Feb. 26	28-921	39-5	36-7	Many cumuli.	
13	29-514	23-5	22-6	Overcast.	1	28-938	39-8	36-4	Cloudy in zen. and NW.	
14	29-503	28-4	28-0	Id. : calm.	2	28-958	39-4	35-8	Many cumuli.	
15	29-479	32-4	31-4	Light rain.	3	28-973	40-1	35-7	Id.	
16	29-459	34-5	33-2	Id.	4	28-983	39-7	34-8	Open sky : cumuli.	
17	29-442	35-5	35-3	Much overcast.	5	28-998	39-5	34-7	Clear : a few cumuli.	
18	29-426	36-1	35-5	Id.	6	29-019	35-0	33-1	Id. : id.	
19	29-413	36-7	35-8	Id.	7	29-048	35-2	32-9	Id. : id.	
20	29-406	36-5	35-8	Id.	8	29-077	34-4	32-2	Id.	
21	29-390	36-4	35-8	Id. : foggy.	9	29-109	33-3	31-8	Cumuli on horizon.	
22	29-381	36-6	35-7	Fog.						
23	29-366	37-7	36-8	Heavy mist.	Mar. 23	10	30-060	33-4	32-8	Overcast : cumuli.
Dec. 23	0	29-344	38-4	37-5	Overcast : mist gone.	11	30-051	34-7	33-6	Id. : calm.
1	29-316	38-6	37-5	Id. ; rain.	12	30-037	35-4	34-1	Id. : id.	
2	29-295	38-5	37-5	Rain : mist in the valleys.	13	30-029	37-1	35-7	Id. : id.	
3	29-284	38-9	37-9	Overcast.	14	30-020	36-2	34-6	Id. : id.	
4	29-277	38-7	37-7	Id.	15	30-008	36-7	35-5	Id. : id.	
5	29-270	39-2	38-4	Id.	16	29-985	39-3	37-9	Id. : id.	
6	29-285	39-1	38-2	Id.	17	29-983	39-7	38-5	Id. : id.	
7	29-316	39-5	38-0	Id.	18	29-990	40-4	39-8	Id. : id.	
8	29-336	39-1	37-3	Cumuli : breaking up.	19	30-002	43-7	41-7	Id. : id.	
9	29-384	39-4	37-1	Clear : mottled-cir. : cir-cum : converging to N.	20	30-017	44-8	42-8	Clouds breaking.	
					21	30-018	46-6	43-7	Overcast : cum. : cum.-str.	
Jan. 19	10	30-006	40-5	39-2	Overcast.	22	30-024	47-8	44-8	Id. : id. : a few cirri.
11	30-008	40-9	39-6	Id.	23	30-017	50-1	46-1	Id. : id.	
12	29-985	40-1	38-4	Id. : light wind.	Mar. 24	0	30-014	51-8	47-1	Id. : id.
13	29-978	39-3	37-7	Clear in zen. : wind rising.	1	30-016	51-9	47-1	Id. : id.	
14	29-977	39-3	37-8	Id.	2	30-005	53-6	49-5	Breaking : cum. : cum.-str.	
15	29-971	39-3	37-8		3	29-982	55-0	49-6	Broken clouds.	
16	29-966	39-0	37-7	Overcast.	4	29-965	55-0	49-6	Clouds dispersing.	
17	29-950	39-4	37-8	Id. : clearing in zen.	5	29-957	54-4	48-8	Clear in zenith.	
18	29-928	39-5	37-8	Quite clear.	6	29-952	52-6	46-6	Clear : a few cumuli.	
19	29-916	37-7	36-3	A few thin clouds.	7	29-941	48-6	44-6	Clear : cirri : cum. on hor.	
20	29-907	37-3	35-6	Clear : linear cirri.	8	29-970	45-8	42-7	Id. : id.	
21	29-917	36-7	35-5	Id. : id.	9	29-970	42-7	40-7	Id. : a few cumuli.	
22	29-911	36-0	34-5	Clear : calm.						
23	29-903	37-5	36-0	Id. : id.	Apr. 20	10	29-973	46-7	43-8	Clear : a few cirri.
Jan. 20	0	29-892	38-6	37-0	Id. : id.	11	29-967	42-0	40-5	Id. : id.
1	29-877	41-2	38-3	Id. : id.	12	29-974	40-8	39-7	Id. : id.	
2	29-868	41-1	38-7	Clear : cirro-cumuli.	13	29-970	41-5	40-5	Much cirrous haze.	
3	29-854	40-6	38-5	Id. : id.	14	29-976	41-2	40-0	Clear : cumuli.	
4	29-852	39-8	37-7	More overcast : cumuli.	15	29-972	38-8	38-2	Id. : faint traces of Aurora.	
5	29-842	38-2	36-4	Clear.	16	29-980	36-8	36-5	Id.	
6	29-835	35-6	34-0	Id. : a few cirri on hor.	17	29-983	35-3	34-7	Id. : calm.	
7	29-836	34-6	33-3	Id. : id.	18	29-972	36-8	36-3	Id.	
8	29-834	34-0	33-1	Very clear.	19	29-972	38-8	38-0		
9	29-836	33-8	32-6	Id.	20	29-971	43-7	41-7	Id. : haze on horizon.	
					21	29-971	47-8	45-6		
Feb. 25	10	28-947	34-5	32-5	Clear.	22	29-975	52-7	47-3	Id. : nearly calm.
11	28-953	33-2	32-0	Id.	23	29-964	56-8	49-1	Id. : id.	
12	28-951	32-7	31-7	A few light clouds : lunar halo.	Apr. 21	0	29-952	59-8	49-9	Id. : id.
13	28-941	32-5	31-5	Id.	1	29-945	63-3	51-7	A few linear cirri.	
14	28-919	31-6	30-8	Cloudy.	2	29-924	65-4	52-0	Linear cirri to W. over $\frac{1}{4}$ of sky.	
15	28-895	31-8	30-9	Id.	3	29-912	66-2	52-0	Id.	
16	28-856	34-8	33-0	Id.	4	29-897	67-8	52-7	Diffuse cirri over sky.	
17	28-832	34-5	33-4	Id. : wind rising.	5	29-890	66-4	55-8	Id.	
18	28-831	35-7	34-1	Id. : light wind.	6	29-887	65-1	55-3	Id.	
19	28-821	34-4	32-9	Clouds breaking : mod. wind.	7	29-892	62-4	55-4	Id.	
20	28-856	34-7	32-8	Snow.	8	29-893	57-1	53-0	Nearly covered with cir-cum and cir-str.	
21	28-864	34-5	33-7	Open sky : cumuli.	9	29-896	55-7	52-3	Id.	

Göttingen Mean Time of Observation.			BARO- METER Corrected.	THERMOME- TERS.		WIND.		STATE OF THE SKY.		
				Dry.	Wet.	Esti- mated force.	Direction.	Clouds moving from	Quan- tity of Clouds.	Species of Clouds, &c.
May 5	8 0	0	29.126	49.8	49.6	0-6	SSW.		0-10.	Light rain.
May 6	8 0	0	28.849	45.6	45.6	Rain.
May 7	23 0	0	28.912	
May 14	23 20		30.180	56.7	
May 15	7 20		30.233	
May 16	6 0	0	30.190	64.1	63.5	
	7 0		30.195	62.6	62.0	
May 21	23 0	0	29.517	58.2	52.0			4.0	Cumuli.
May 29	0 0	0	29.697	59.5	52.5	1.5			6.0	Cumuli and cirri.
May 27	10 0	0	29.661	49.9	47.4	0.0			2.0	Cirri.
	11 0	0	29.665	47.4	45.6	0.0			2.0	Cirri to N., pointing NNE.
	12 0	0	29.669	46.7	45.5			2.0	Id. : id. N.
	13 0	0	29.667	45.4	44.3			2.0	Id. : id.
	14 0	0	29.662	44.0	43.4			2.0	Id. : moving off to E.
	15 0	0	29.663	43.1	42.5	0.0			0.0	
	16 0	0	29.660	44.2	43.5	0.0			1.0	Cirri : cirro-strati.
	17 0	0	29.650	43.6	42.8	0.0			1.0	Cirro-strati to E.
	18 0	0	29.665	46.8	44.9	0.0			0.0	Clear.
	19 0	0	29.667	52.0	48.9	0.0			0.0	Id.
	20 0	0	29.682	52.1	49.1			10.0	Overcast : light breeze.
	21 0	0	29.688	55.1	50.9	Clearing : id.
	22 0	0	29.681	58.7	51.4	0.3			5.0	
	23 0	0	29.687	58.3	51.7	0.5	W.	W.	6.0	Cumuli.
May 28	0 0	0	29.692	59.8	51.9	0.6	W.	0.	3.0	Id.
	1 0	0	29.695	60.0	52.2	0.3	W.		8.0	Id.
	2 0	0	29.699	58.5	51.2	0.8	W.		9.0	Id.
	3 0	0	29.704	59.2	51.4	0.8			8.0	Cumuli in ranges round horizon.
	4 0	0	29.708	60.1	52.4	0.3			Id.
	5 0	0	29.718	59.8	51.0	0.5			2.0	Id.
	6 0	0	29.721	57.9	50.5			3.0	Cumuli : cirri.
	7 0	0	29.723	57.7	50.2	0.3			1.0	Id. : id.
	8 0	0	29.722	55.1	49.4	0.0			3.0	Id. : id.
	9 0	0	29.730	51.9	48.9	0.0			6.0	
June 5	2 0	0	29.710	64.0	54.7			6.0	Light showers during the day.
June 11	23 20		30.187	58.5	55.1	0.0			0.3	Linear cirri.
June 18	23 30		29.555	52.7	47.8	1.3		E.	10.0	
June 20	20 0	0	29.349	57.2	55.8	0.0			10.0	Scud.
	21 30		29.340	63.6	59.4	0.3		S : 0.	9.0	Scud and cumuli : cirro-cumuli.
	23 0	0	29.336	63.9	60.1	0.3	SSW.	SSW.	8.7	Id. : id. : linear cir.
June 21	0 0	0	29.334	63.9	59.9	0.5	SSW ?	SSW.	9.7	As at 23 ^h , passing showers.
	1 0	0	29.331	66.8	60.4	0.4		SSW.	8.0	Scud and cum. : cirri, &c. : towering cum. to N.
	2 0	0	29.314	69.3	61.9	0.3			5.0	Towering cum and nimbi : cir. : like thunder.
	3 0	0	29.301	69.8	61.0	0.2			6.0	Cum. : nimbi : cirri, &c. [hail.
	4 0	0	29.282	61.8	59.9	0.3		E by N : SSW : 0.	9.0	Cum. : nimbi : cirri : thunder-storm : rain :
	5 0	0	29.288	61.6	59.2	0.5	SSE.		10.0	Nimbi, &c. : thunder : light rain.
	6 0	0	29.311	57.5	55.5	0.0		SSE.	10.0	Nimbi : heavy rain : thunder-storm.
	7 5		29.320	56.4	55.5	0.0			10.0	Nimbi : distant thunder.
	8 15		29.318	56.7	56.1	0.0			9.9	Nimbi and scud : cirro-strati, &c. [to SE.
	8 50		29.316	56.5	56.0	0.0		SW : SE.	9.7	Cirro-cumulous scud : nimbi and scud : rain
June 21	20 0	0	29.348	55.7	50.7	0.5	W.	W.	2.0	Scud : cum.-str. : cir.-str. : cirri.
	21 0	0	29.407	56.7	51.2	0.4	W.		3.5	Id. : id. : id. : id.
	23 0	0	29.420	59.3	51.1	0.5			5.0	Cumuli : reticulated cirri.
June 22	0 5		29.428	60.5	52.2	0.3			9.0	Id. : id.
	2 0		29.424	64.6	54.6	0.8		WSW.	7.0	Id. : cirri.
	3 0		29.431	64.1	53.9		WSW.	6.0	Id. : cir-haze : fibrous cirri.
	5 0		29.436	62.6	53.9	0.6			8.0	Id. : cir-haze chiefly, cir-cum.
	6 40		29.442	63.7	53.7	0.3			8.0	Cum. on hor. : cirri.
	10 0		29.463	51.6	48.6	0.0			3.0	Cirro-cumuli to S. : cirri and cumuli to NE.

Göttingen Mean Time of Observation.			BARO- METER Corrected.	THERMOME- TERS.		WIND.		STATE OF THE SKY.		
				Dry.	Wet.	Esti- mated force.	Direction.	Clouds moving from	Quan- tity of Clouds.	Species of Clouds, &c.
June 22	11 0		29.467	48.9	47.1	0-6.	W.		0-10.	Clouds on hor. : clear in zen.
	12 0		29.472	46.9	45.3	0.0			2.0	Cumuli, &c. to S.
	13 0		29.474	48.4	45.8	0.3			8.0	Chiefly large cirro-cumuli.
	14 0		29.473	46.6	44.2	0.3			3.0	
	15 0		29.477	44.0	43.0	0.5			1.0	Cirri to E.
	16 0		29.471	42.0	41.2	0.3			2.0	Id.
	17 0		29.476	43.8	42.7	0.0			0.5	Linear cirri to E.
	18 0		29.480	49.1	46.9	0.0			0.5	
	19 0		29.493	55.2	50.9	0.0			0.5	
	20 0		29.493	57.6	52.9	0.0			0.5	
	21 0		29.489	57.5	52.7	0.3			0.8	
	22 0		29.480	59.5	52.9	0.0			3.0	
	23 0		29.472	60.3	52.0	0.0			3.0	
June 23	0 0		29.471	62.3	53.7	0.3	W.		1.3	
	1 0		29.457	63.9	54.2	0.3			1.5	
	2 0		29.447	63.1	54.5	Cumuli, chiefly on hor. : cirri.
	3 0		29.438	63.7	52.8	0.6	WSW.		7.0	Cumuli on hor. : cirri : cir-haze.
	4 0		29.434	61.6	52.7	0.6	WSW.		9.0	Id. : id. : id.
	5 0		29.418	60.0	52.1	0.3			7.0	
	6 0		29.386	60.8	53.0	0.3			7.0	Id.
	7 0		29.356	58.8	51.9	0.3			10.0	
	8 0		29.322	56.5	51.9			10.0	Scud.
	9 0		29.288	55.6	52.1	0.3			10.0	Id.
	10 0		29.249	54.1	52.8	
June 25	23 0		29.207	57.0	50.4	1.8			9.5	Cumuli.
June 27	8 2		29.930	55.9	50.1	0.6	WNW ?		7.0	Fine cir.-cum. radiating from NW.
June 28	8 30		29.647	58.7	57.0	2.0	SW.	SW : 0.	10.0	Scud : cir.-cum.
June 29	8 35		29.707	55.5	49.5	0.8	W.	W : 0.	8.0 ?	Scud : cirro-strati : cirri.
July 1	20 0		29.382	51.7	49.9			10.0	Scud : cirri : light rain.
	21 0		29.386	50.0	49.0			10.0	Rain.
	22 0		29.386	51.0	49.3			10.0	
	23 0		29.395	50.4	47.8			10.0	Scud : cumuli.
July 2	0 0		29.398	52.7	49.5	
	1 0		29.408	52.4	49.6	0.3			10.0	
	2 0		29.415	55.3	51.4	0.5			9.9	Scud : cumuli : rain.
	3 0		29.436	55.2	50.9	0.0			8.0	Cumuli : cirri.
	5 0		29.465	56.9	51.7	1.0			6.0	Cum. : cir.-cum. : cir.-str.
	6 0		29.501	53.7	50.9	1.0			9.5	Cumuli.
	7 0		29.530	53.0	50.0	0.2			9.5	Cumuli : large cirro-cumuli.
	9 0		29.561	51.4	48.9	
	12 0		29.601	48.4	47.3	
	13 0		29.606	49.1	47.9	
July 3	1 0		29.636	56.5	52.9	0.0			7.5	Scud : rain.
	20 0		29.382	50.6	49.6	0.0			10.0	Id.
	21 0		29.364	
	22 0		29.345	56.6	54.0	0.0			10.0	
	23 0		29.329	60.0	56.6	
July 4	0 0		29.308	59.9	57.1	0.0			10.0	Scud : light rain.
	1 0		29.286	59.9	58.1	
	2 0		29.261	59.9	58.0			10.0	Scud.
	3 0		29.237	64.4	62.1	0.0		SW.	10.0	Id., moving quickly.
	4 0		29.222	63.1	59.5	0.3			10.0	
	5 0		29.200	63.8	59.2	0.4			10.0	Cumuli : thick cirrous haze.
	6 0		29.190	62.0	57.6	1.5			10.0	Id. : id.
	7 0		29.166	61.5	58.0	0.3			10.0	Scud : rain.
July 7	8 45		29.438	53.7	52.0	0.8	S.		10.0	Indefinable mass : showers.
July 18	8 40		29.716	57.1	55.4	0.8		ESE.	10.0	Scud : cirro-cumuli : linear cirri.
July 20	10 0		29.629	52.5	50.6	0.8			10.0	
	11 0		29.637	52.6	50.3	0.5			9.8	Breaking to N.

114 TERM-DAY AND EXTRA METEOROLOGICAL OBSERVATIONS, JULY 20—SEPTEMBER 21. 1842.

Göttingen Mean Time of Observation.			BARO- METER Corrected.	THERMOME- TERS.		WIND.		STATE OF THE SKY.		
				Dry.	Wet.	Esti- mated force.	Direction.	Clouds moving from	Quan- tity of Clouds.	Species of Clouds, &c.
July 20	d. h. m.	in.	°	°	0-6.			0-10.		
	12 0	29.648	52.0	49.6	0.2			10.0		
	13 0	29.645	51.8	50.3	0.0			10.0		
	14 0	29.637	51.6	49.9			10.0		
	15 0	29.634	51.4	49.4	0.0			10.0		
	16 0	29.623	51.4	49.4	0.3			9.0		
	17 0	29.619	50.5	49.0	0.0			7.0	Cirro-cumuli.	
	18 0	29.620	53.7	50.4			2.0	Id. : cirri.	
	19 0	29.613	56.0	51.6	0.3			2.0	Loose cumuli : cirri to N.	
	20 0	29.616	56.6	52.7	0.3	N by E.		2.0	Cumuli : haze to SE.	
	21 0	29.621	56.0	52.0	0.3	N by E.		3.0		
	22 0	29.614	57.4	51.9	0.3	N by E.		3.0		
	23 0	29.627	58.6	52.9	0.8	N by E.	N by E : ENE : 0.	6.0	Two currents of loose cumuli : cirro-cumuli.	
July 21	0 0	29.643	58.3	52.2	1.0	N by E.		4.0	Loose cumuli.	
	1 0	29.646	58.6	52.6	1.5	N by E.		4.0	Id.	
	2 0	29.649	58.8	52.7	0.5	N by E.		9.0	Id.	
	3 0	29.646	57.7	51.9	1.0		N by E : NNW.	7.0	Scud : cumuli.	
	4 0	29.650	60.0	53.0	0.5			5.0	Id.	
	5 0	29.651	58.0	50.9	0.5			2.0		
	6 0	29.659	58.8	51.7	0.5			2.0	Id.	
	7 0	29.667	57.1	51.0	1.0	N by E.		1.0	Id.	
	8 0	29.682	55.0	49.5	0.8			1.0	Id.	
	9 0	29.697	51.8	47.4	0.5	N by E.		1.0	Piles of craggy cumuli from N. to SE.	
	10 0	29.713	51.6	47.6	1.3	N ?	NNE.	4.0	Mass of loose cumuli.	
Aug. 19	6 0	29.569	67.1	63.8	0.0			10.0	Cirrous clouds and haze.	
	7 0	29.521	67.6	62.7	0.2		SSW.	10.0	Loose cum. : cir.-haze.	
	8 0	29.523	65.6	62.3	0.0			10.0	Cirrous clouds and haze.	
Aug. 26	10 0	29.847	54.9	53.2	0.0			10.0		
	11 0	29.852	54.9	53.1	0.2	NE.		10.0		
	12 0	29.851	54.8	53.0	0.2	NE.		10.0		
	13 0	29.853	54.9	53.0	0.2	NE.		10.0		
	14 0	29.850	54.9	53.5	0.0			10.0		
	15 0	29.847	55.0	53.7	0.0			10.0		
	16 0	29.841	54.9	53.6	0.0			10.0		
	17 0	29.838	55.0	53.7	0.0			10.0		
	18 0	29.847	55.2	53.5	0.1			10.0		
	19 0	29.853	55.0	53.3	0.2			10.0		
	20 0	29.861	55.6	53.4	0.3		NE.	10.0	Scud.	
	21 0	29.866	56.5	53.5	0.5		NE.	9.9	Id. : cirro-cumuli.	
	22 0	29.866	58.1	54.8	0.6			8.5	Id. : id.	
	23 0	29.864	59.0	54.8	0.3	NE.		8.0	Id. : id.	
Aug. 27	0 0	29.857	60.6	55.7	0.3	NE.		8.0	Id. : id.	
	1 0	29.850	61.6	56.0	0.3	NE.		7.0	Id. : id.	
	2 0	29.849	63.9	57.7	0.8	NE.		5.0	Id. : id.	
	3 0	29.848	63.7	58.1	0.8	NNE.		3.5		
	4 0	29.841	62.9	57.1	0.3	NE.		4.0		
	5 0	29.839	63.8	57.0	0.3	NNE.		5.0		
	6 0	29.837	62.6	56.4	0.5	NNE.		9.0	Patches of scud : loose cumuli.	
	7 0	29.846	60.5	56.0	0.3	NNE.		8.0	Id. : id.	
	8 0	29.858	57.9	53.8	0.0		E.	6.0	Loose cumuli.	
	9 0	29.868	54.5	52.4	0.0			4.0	Cirro-cumuli.	
	10 0	29.872	53.7	51.7	0.0			9.7		
Sept. 2	9 0	29.819	63.0	61.2			10.0	Scud.	
Sept. 20	19 0	29.302	41.9	41.3	0.0			10.0	Homogeneous mass : light mist.	
	20 0	29.312	43.4	42.8	0.0		E.	10.0	Scud, &c. : heavy mist.	
	21 0	29.321	44.4	43.8	0.0			10.0	Homogeneous : rain since 20 ^h 30 ^m .	
	22 0	29.342	45.8	45.4	0.0		E : N.	10.0	Two currents of scud : light rain.	
	23 0	29.346	49.0	48.0	0.0		NE ?	9.5	Scud : nimbi ? : smart shower.	
Sept. 21	0 0	29.338	51.8	49.7	0.2		Various.	5.0	Scuds : cir.-cum. : cum.	
	1 0	29.331	54.9	52.9	0.2	NNE.	NNE : SW : WNW.	4.5	Scud : cumuli.	

Göttingen Mean Time of Observation.			BARO- METER Corrected.	THERMOME- TERS.		WIND.		STATE OF THE SKY.				
				Dry.	Wet.	Esti- mated force.	Direction.	Clouds moving from	Quan- tity of Clouds.	Species of Clouds, &c.		
Sept. 21	d.	h.	m.	in.	°	°	0-6.			0-10.		
	2	0		29.331	56.0	50.7	0.3	NE.	NE.	3.0	Scud : cumuli.	
	3	0		29.327	56.1	49.8	0.6	NE.	S : various.	6.0	Id. : id. : cirri.	
	4	0		29.329	55.5	49.9	0.3	ENE.	N by E : NE : S.	7.0	Id. : cirro-cumuli.	
	5	0		29.332	54.1	49.5	0.3	NE.	NW : SSE.	8.0	Two currents of cirro-cumuli : cum. on hor.	
	6	0		29.338	52.7	49.0	0.2			7.5	Scud : large loose cir.-cum. moving very slowly : cum.	
	7	0		29.350	49.6	48.4	0.0		NE ?	6.0	Scud : cirro-cumuli : thunder to S. at 6 ^h 30 ^m .	
	8	0		29.352	46.5	45.8	0.0			5.0	Cirro-cumuli.	
	9	0		29.354	45.4	44.8	0.0			9.0	Cir.-cum. to E. : heavy cum. to W.	
	10	0		29.360	46.8	46.2	0.0		NE.	9.0	Cir.-cum. : cumuli on hor.	
	11	0		29.364	47.0	46.3	0.0		NE.	8.0	Cirro-cumuli : scud.	
	12	0		29.361	43.8	43.6	0.0		NE.	8.0	Scud and loose cumuli.	
	13	0		29.361	44.0	43.5	0.0		NE.	7.5	Id.	
	14	0		29.365	44.2	43.8	0.0		NE.	6.5	Id.	
	15	0		29.349	45.2	44.6	0.0		NNE.	7.0	Id. : cum. on NE. hor.	
	16	0		29.345	46.3	45.4	0.0		NNE.	9.0	Id. : id.	
	17	0		29.344	45.4	44.9	0.0		N.	6.0	Large cirro-cumuli and cumuli.	
	18	0		29.341	45.8	45.6	0.0		NE.	9.7	Scud : cir.-haze.	
	19	0		29.346	48.4	47.0	0.0		NE : SSE.	9.7	Two currents of scud : cir.-haze.	
	20	0		29.345	49.9	47.9	0.0		NE : SSE.	10.0	Id. : id.	
	21	0		29.336	51.8	48.9	0.3	N.	N.	8.0	Scud : cirri : much cirrous haze.	
	22	0		29.345	52.7	49.3	0.5	N.	N.	10.0	Scud.	
	23	0		29.344	54.0	48.6	0.5	N.		10.0	Cumuli on hor. : breaking.	
Sept. 22	0		29.339	54.0	48.8	0.5	N.		10.0	Id. : id.		
	1	0		29.336	54.9	49.3	0.5	N.	N.	10.0	Scud : much cirrous haze.	
	2	0		29.333	55.0	49.1	0.5	N.	N.	10.0	Id. : id.	
	3	0		29.313	55.1	49.6	0.5	N.		10.0	Id. : id.	
	4	0		29.301	54.2	49.6	1.0			10.0	As at 3 ^h , a few drops of rain.	
	5	0		29.297	52.9	48.5	0.3	N.		10.0	Scud : rain.	
	6	0		29.295	51.1	47.8	0.3			10.0	Id. : id.	
	7	0		29.283	50.1	47.1	0.8	N.		10.0	Id. : light rain.	
	8	0		29.284	48.9	46.8	0.4	N.		10.0	Id.	
	9	0		29.271	48.5	46.6	0.5	NNW.		10.0	Id. : smart shower.	
	10	0		29.252	48.4	46.8	0.5	N ?		10.0	Id. : heavy rain.	
Oct. 17	6	0	29.429	47.9	44.8			
Oct. 19	10	0		29.294	34.4	31.5	0.4	WNW.		1.0	Linear and woolly cirri : cum. on hor.	
	11	0		29.287	32.8	30.6	0.5	W by N.		0.5	Clouds on horizon.	
	12	0		29.296	33.2	30.5	0.4	WNW.		0.3	Id. : cumuli ?	
	13	0		29.314	32.6	30.1	0.3	W by N.		0.0		
	14	0		29.316	30.6	29.4	0.0			0.0		
	15	0		29.311	30.1	28.8	0.3	W by S.		0.0	Cumuli on NE. hor. : lunar corona.	
	16	0		29.314	27.5	27.3	0.0			0.0	Id. : id.	
	17	0		29.316	27.2	26.6	0.0			0.0	Lunar corona.	
	18	0		29.328	29.7	28.1	0.0			0.0	A few clouds on E. hor. : faint corona.	
	19	0		29.331	27.2	26.6	0.0			0.0		
	20	0		29.340	29.7	28.3	0.0			1.0	Heavy cumuli on E. hor.	
	21	0		29.354	33.5	30.9	0.0			1.0	Id.	
	22	0		29.360	34.9	33.0	0.3	SW by W.		1.0	Fine cumuli on E. hor. : cir.-cum in zen.	
	23	0		29.377	39.5	35.3	0.3	W by S.	N by W : W.	2.0	Loose cum. : loose cir.-cum. : towering cum.	
	20	0		29.385	41.0	35.6	0.5	N by W.	NW.	1.0	Cumuli round horizon. [on E. hor.]	
		1	0		29.385	41.0	35.0	0.5	N by W.	W.	1.5	Id.
		2	0		29.397	41.7	35.5	0.8	N by W.	NW.	2.0	Id.
		3	0		29.394	42.2	35.7	0.7	NW ?		1.5	Id.
		4	0		29.412	41.7	35.5	0.3	NW by N.		1.5	Id.
		5	0		29.432	39.5	34.4	0.3	NNW.		2.0	Cumuli on NE. and S. hor.
6		0		29.469	34.3	30.9	0.3	NNW.		2.0	Id.	
7		0		29.487	33.5	30.9	0.0			0.3	Id.	
8		0		29.490	33.0	30.6	0.0			0.3	Id.	
9		0		29.529	34.4	31.4	0.3	NNW.		0.3	Id.	
10	0		29.553	32.4	29.8	0.3	N by W.		0.3	Id.		
Nov. 12	7	0	28.888	45.8	43.2			
Nov. 19	8	0	29.475	46.6	45.6	0.5			10.0	Wind rising.		

Göttingen Mean Time of Observation.			BARO- METER Corrected.	THERMOME- TERS.		ANEMOMETER.			STATE OF THE SKY.		
				Dry.	Wet.	Pressure.		Direction of Wind.	Clouds moving from	Quan- tity of Clouds.	Species of Clouds, &c.
						Max.	Pres.				
Nov. 25	d. h. m.	in.	°	°	lbs.	lbs.			0-10.		
	10 0	28.641	41.2	39.8	1.5	0.5	E.N.E.		9.5	Scud.	
	11 0	28.644	40.9	40.0	0.5	0.0			8.5	Id.	
	12 0	28.646	41.6	40.4	0.0	0.0			10.0	Id.	
	13 0	28.643	41.3	40.7	0.0	0.0			10.0	Id.	
	14 0	28.644	40.5	39.9	0.0	0.0			10.0	Id. : light shower.	
	15 0	28.645	39.1	38.7	0.0	0.0			8.7	Id.	
	16 0	28.659	38.0	37.6	0.0	0.0			5.0	Id.	
	17 0	28.662	36.7	36.0	0.0	0.0			7.0	Id.	
	18 0	28.671	37.3	36.6	0.0	0.0			10.0	Id.	
	19 0	28.674	37.2	36.6	0.0	0.0			10.0	Id.	
	20 0	28.678	37.4	36.7	0.0	0.0		SE by E.	9.9	Id. : hazy : red to E. : showers.	
	21 0	28.686	37.9	37.4	0.3	0.0		SE ?	9.9	Id. : id. : id. : cum. on E. hor.	
	22 0	28.694	38.5	37.8	0.0	0.0			9.0	Sky to S.	
	23 0	28.700	39.0	38.5	0.0	0.0			8.0	Sky in zen. : heavy clouds in hor.	
Nov. 26	0 0	28.713	39.7	39.1	0.0	0.0		SE ?	10.0	Scud.	
	1 0	28.711	39.7	39.2	0.0	0.0			10.0	Id. : hazy.	
	2 0	28.711	40.2	39.5	0.0	0.0			10.0	Id. : id.	
	3 0	28.710	40.5	39.3	0.0	0.0			10.0	Id.	
	4 0	28.725	40.5	39.5	0.0	0.0		S by E.	9.7	Cirro-cumulous scud : sky to S.	
	5 0	28.731	39.9	39.3	0.0	0.0			10.0	Dense scud.	
	6 0	28.743	40.5	39.4	0.3	0.3	E.S.E.		10.0	Id.	
	7 0	28.759	40.5	39.1	0.0	0.0			10.0	Id.	
	8 0	28.775	40.0	39.4	0.0	0.0			10.0	Id. : rain.	
	9 0	28.795	39.9	39.4	0.3	0.0			10.0	Very dark.	
	10 0	28.814	39.8	39.0	0.3	0.0			7.0	Id.	
Dec. 9	7 0	30.188	44.5	44.2	0.0	0.0	NE ?		10.0		
Dec. 20	20 0	29.979	48.0	46.6	3.3	0.0		WNW.	3.0	Fine cirri : cirrous cirro-cumuli.	
	21 0	29.979	47.2	43.6	0.5	0.3	SSW.	WNW.	1.5	Fine cirrous clouds : mottled cir. : cir.-str.	
	22 0	29.987	44.9	43.2	0.8	1.5	SSW.	WNW.	3.0	Cirro-cum. : varieties of cirri.	
	23 0	29.993	47.4	44.9	0.8	0.5	SSW.	WNW.	8.0	As before : cymoid-cirri at 23 ^h 30 ^m .	
Dec. 21	0 0	29.984	48.6	45.8	1.0	0.8	SW.	WNW.	9.0	Large woolly cir.-cum. : cir.-str. : cir.	
	1 0	29.978	49.9	47.2	1.5	0.8	SW v.	W ?	10.0	Scud : semi-fluid cir.-str. : sky troubled like.	
	2 0	29.963	50.5	47.4	1.5	0.5	SW.		10.0	Id. : cir.-clouds unevenly spread.	
	3 0	29.938	50.8	48.8	1.3	1.3	SW.	WSW:SW:WNW.	10.0	Scuds : thick cir.-clouds.	
	4 0	29.917	51.3	49.4	2.0	1.3	SW.	SW : W : W.	9.0	Id. : id. : sky troubled like.	
	5 0	29.895	51.3	49.6	1.8	1.3	SW.	SW.	9.0	Id. : id.	
	6 0	29.893	50.8	49.6	2.0	1.0	SW.	SW.	10.0	Id. : dark.	
	7 0	29.893	51.6	50.2	1.8	0.8	SW.		10.0	Quite dark.	
	8 0	29.883	51.9	50.4	1.3	0.5	SW.		9.9	Dark to N. : scud ? : cir.-haze.	
	9 0	29.844	51.7	50.1	2.3	1.3	SW by W.		4.0	Dark.	
	10 0	29.830	52.1	50.4	2.0	1.8	SW.	SW.	10.0	Scud : cirri radiating from SE.	
	11 0	29.824	52.1	50.4	2.3	0.8	SW.		8.0	Id. : sky in zenith.	
	12 0	29.757	50.3	48.4	2.0	1.5	SW.	SW.	8.0	Id.	
	13 0	29.730	49.6	47.4	2.8	2.5	SW.		9.0	Id. : cirri.	
	14 0	29.753	49.0	46.6	3.0	1.8	SW.	SW.	8.0	Id.	
	15 0	29.734	49.0	46.5	2.8	2.5	SW.		8.0	Id.	
	16 0	29.727	49.0	46.6	2.8	1.0	SW.		10.0	Id.	
	17 0	29.699	49.1	46.7	1.8	1.3	SW by S.		9.8	Dark scud.	
	18 0	29.654	48.5	45.6	3.3	3.3	SW.		5.0	Cirrous clouds on horizon.	
	19 0	29.617	48.6	45.6	3.0	2.3	SW.		5.0	Id.	
	20 0	29.606	49.4	46.4	4.5	2.0	SW.		10.0	Scud.	
	21 0	29.585	49.4	46.4	3.0	2.0	SSW.	SW.	10.0	Id.	
	22 0	29.568	48.6	46.6	3.5	1.8	SW.	SW.	10.0	Id. : cirrous clouds, [clouds.	
	23 0	29.526	49.2	47.1	2.8	2.8	SW.		9.9	Smoky scud very low and quickly : cirrous	
Dec. 22	0 0	29.482	49.5	47.2	4.8	5.3	SW.	SW.	9.7	Scud moving rapidly.	
	1 0	29.457	49.3	47.1	5.0	3.0	SW.	SW.	9.0	Scud : cirrous clouds.	
	2 0	29.448	50.5	47.4	7.0	3.0	SW.		1.5	Id. : id.	
	3 0	29.431	49.4	47.1	3.8	2.8	SW.		8.0	Heavy rain : sky to N.	
	4 0	29.402	48.6	45.4	4.5	3.3	SW.		1.5	Cumuli on horizon.	
	5 0	29.404	47.9	45.1	3.5	1.5	SW.		10.0	Scud : light rain.	
	6 0	29.392	46.4	43.7	2.5	1.5			10.0	Id. : dark.	
	7 0	29.384	44.6	42.8	2.3	1.3			2.0		
	8 0	29.354	44.8	42.5	5.5	2.0	SW.		8.0	Sky near horizon.	
	9 0	29.334	44.6	41.7	2.5	2.0			7.0	Scud.	
	10 0	29.303	43.8	41.5	5.3	4.3			7.0	Id. : light rain.	

REMARKS ON THE WEATHER.

MAY—DECEMBER, 1842.

MAY.

- | d | h | d | h | |
|----|-------|----|---|--|
| 1 | 20—2 | 5. | | 20 ^h . Clouds beginning to break. 23 ^h . Sky milky: a few cirro-strati to S. 2 ^h . Cumuli, separated into distinct masses. 5 ^h . Cumuli, principally on W. and NW. horizon. |
| 2 | 20—3 | 5. | | 20 ^h . Sky milky in E., almost becoming cirro-strati. 23 ^h . Detached cumuli rising in SE.: fine bands of cirro-cumuli stretching from S by E to NW., forming arcs of large radius. 2 ^h . Large masses of cumuli rising from S.E.: extremely hazy to SE. 3 ^h . The upper strata of cumuli separating from each other approach nearer and nearer the zenith, each cumulus having a cirrous tail, which first points W., then NNW.: large masses of cumuli from the E. hurrying past to NNW., while the cirro-cumuli are slowly progressing across the zenith to ENE. 5 ^h . Cumuli, looking very electric, small spaces of milky blue seen between. |
| 3 | 20—4 | 5. | | 20 ^h . Heavy black cumuli. 23 ^h . Sky seen in NW. 2 ^h . Heavy detached cumuli. 5 ^h . Cumuli round horizon: a few linear cirri. |
| 4 | 20—5 | 3. | | 20 ^h . Light drizzle of rain. 23 ^h . Cumuli, tendency to open in SE. 2 ^h . Masses of black clouds. 8 ^h . Light rain. |
| 5 | 20—6 | 8. | | 20 ^h . A small opening in SE. by E. 23 ^h . Cumuli and scud: heavy shower. 2 ^h . Detached cumuli and scud. 5 ^h . Black cumuli and scud. 8 ^h . Rain. |
| 6 | 20—7 | 5. | | 20 ^h . Cumuli and scud. 23 ^h —2 ^h . Heavy rain. 5 ^h . Heavy rain: clouds moving rapidly: occasional pieces of sky. |
| 8 | 20—9 | 5. | | 20 ^h . Sky in N. and W. horizon: cumuli, &c.: linear cirri above stationary. 23 ^h —5 ^h . Cumuli. |
| 9 | 20—10 | 5. | | 20 ^h . A few linear cirri to E. 23 ^h . Detached cumuli, principally to SE. 2 ^h —5 ^h . Cumuli. |
| 10 | 20—11 | 5. | | 20 ^h . Sky mostly covered with diffuse cirri: a few cirro-strati: the wind does not extend to the cirri: one or two diffuse cumuli, rising from S. and SW. 23 ^h . Two-tenths of the sky covered with cirro-cumuli: four-tenths cumuli: and one-tenth thin cirri. 2 ^h . Electric-looking cumuli lowest: diffuse cirro-cumuli above stationary: linear cirri highest: stationary. 5 ^h . A heavy shower of rain. |
| 11 | 20—12 | 5. | | 20 ^h . A smart shower, raining from 20 ^h till 23 ^h . 2 ^h . Heavy cumuli, moving very slowly: diffuse cirri above stationary. 5 ^h . Cumuli. |
| 12 | 20—13 | 5. | | 20 ^h . Principally cirro-cumuli: a few connected ranges of cumuli: to the North the ill-defined cirro-cumuli form a great bay, almost half an ellipse; there is a portion of a similar bay to the S. of W. 23 ^h . Diffuse cirro-cumuli: the sky almost covered with a haze: a few cirro-strati: one or two cumuli rising. 2 ^h . Irregular cirro-cumuli: masses of cumuli rising from S., SE., and SW., proceeding slowly towards NW.: sky very hazy: the sun projects a faint shadow. 5 ^h . A few cumuli below quite detached: like buttermilk above, and in many places like that liquid agitated. |
| 13 | 20—14 | 5. | | 20 ^h . Clouds motionless: a large kind of flaky cirro-cumuli: the sky covered with haze, in some places approaching to cirrus, towards the East it is quite milky: the sun projects a faint shadow. 23 ^h . Cumuli round horizon, excepting about E., where there is a dense haze: the whole sky is very milky: the sun projecting a moderately dark shadow: occasionally a puff of wind. 5 ^h . Sky covered with haze: no clouds. |
| 15 | 20—16 | 5. | | Sky not so milky as on the last three days. 23 ^h . A few cumuli on NNW. horizon, and a few patches of cirri. 2 ^h . Cumuli on WNW. and SSE. horizon. 5 ^h . Cumuli on S. horizon. |
| 16 | 20—17 | 5. | | 20 ^h . Overcast. 23 ^h . Cumuli, disappearing rapidly. 2 ^h . Very detached cumuli round horizon: a mass of cirri to N., with the concave side to SW.: faint linear cirri, &c. over the sky. 5 ^h . Cirri, principally to S., with the concave side to NW. |
| 17 | 20—18 | 5. | | 20 ^h . Overcast. 23 ^h . Cumuli in the zenith, about four-tenths of ill-defined cirro-cumuli: sky hazy: clouds breaking. 2 ^h . Principally cumuli, and a few cirro-strati on horizon: a few patches of ill-defined cirro-cumuli in zenith. 5 ^h . Ranges of cumuli round horizon from SE. round by S. to NE.: a few patches of cirro-cumuli. |
| 18 | 20—19 | 5. | | Overcast throughout the day. |
| 19 | 20—20 | 5. | | 20 ^h . Cumuli: mixed and linear cirri to N., and in zenith. 23 ^h . Cumuli much dispersed: cirri above stationary. 2 ^h . Principally heavy cumuli rising in S., proceeding North, looking very electric in S. and E. 5 ^h . Cumuli and nimbi: rain to E. and S. |
| 20 | 20—21 | 5. | | 20 ^h . A few cumuli: large diffuse cirro-cumuli stationary. 23 ^h . Cumuli: a few patches of sky to N. 2 ^h . Cumuli. 5 ^h . Overcast. |

The column "Species of Clouds, &c." in the Meteorological Observations after May 1. 1842, is an abstract of the Remarks given here, which are frequently too lengthy to have been printed along with the other Meteorological Observations.

MAY.

- d h d h
 22 20—23 5. 20^h. A smart shower beginning to fall. 23^h. Heavy rain began at 22^h 45^m. 2^h. Cumuli, principally on horizon. 5^h. Cumuli.
- 23 20—24 5. 20^h. Cirri and cirro-strati: a few cumuli appearing to SE. 23^h. Principally cumuli round N. horizon, with large black watery looking masses rising from S.: sky quite covered with a dense haze: the sun projects only a faint shadow: a few clouds like cirro-strati to S. and E. 2^h. Overcast. 5^h. Like cirro-strati, with cumuli near horizon, calm, all as if arrested in their progress.
- 24 20—25 5. 20^h. Overcast. 23^h. Cumuli: clouds opening to S. 2^h. Cumuli: linear cirri above stationary: clouds looking electric. 5^h. Sky covered with nimbi: loud thunder: brilliant flashes of lightning, followed by heavy rain: quite dark to S.
- 25 20—26 5. 20^h. A dense mist lies over the ground. 23^h. Heavy black cumuli: clouds still looking electric. 2^h. Cumuli moving from S., and lying in thick ranges round horizon. 5^h. Black cumuli: sky to NW.
- 26 20—27 5. 20^h. Overcast: foggy. 23^h. Dark cumuli: a speck of blue to NE. 2^h. Cumuli: beautiful ranges of cumuli round horizon: the sky in patches here and there. 5^h. Cumuli in ranges round horizon: beautiful vertebrated cirri lying from SW. across E. of zenith to NE.; the lines of cirri beautifully fine, like some woven wool; these appear stationary, or nearly so, while a lower current carries parallel flocks of cirri moving to NE., but lying at right angles to the direction of the others, thus giving the appearance of vertebræ.
- 27 10—28 9. 10^h. Cirri and cirro-strati. 11^h. Principally linear cirri to N. pointing NNE. 12^h. The same directed to N. 13^h. The same radiating from N. 14^h. The same moving off to E. 16^h. Cirro-strati and cirri. 17^h. Cirro-strati to E. 18^h—19^h. Clear. 20^h. Overcast: light breeze. 21^h. Clearing: still cloudy: wind as before. 23^h—2^h. Cumuli. 3^h. Cumuli in ranges round horizon. 4^h—5^h. Cumuli, &c. on horizon. 6^h. Cumuli and cirro-strati. 7^h. Cumulo-strati and cirro-strati. 8^h. Cirro-strati over two-tenths of sky, cumuli one-tenth.
- 29 20—30 5. 20^h. Watery looking cumuli rising from SW. and creeping across to NE.: cirro-strati and cirro-cumuli to NE.: very rainy like to SE. 23^h. As at 20^h, a few specks of cirro-cumuli. 2^h. Cumuli and nimbi: showers going round: masses of feathery cirri stationary. 5^h. Cumuli and nimbi: a light shower passing.
- 30 20—31 5. 20^h—23^h. Cumuli. 2^h. Cumuli: a few fine linear cirri above. 5^h. Watery looking cumuli.
- 31 20—31 23. 20^h. Beginning to break: cirri and cirro-strati. 23^h. Cumuli and linear cirri.

JUNE.

- 1 2—1 5. 2^h. Cumuli. 5^h. Scud: light showers passing over.
- 1 20—2 5. 20^h. Cirri to E.: a few detached specks of cumuli rising from SE. 23^h. Cumuli, with a few reticulated and other cirri, all moving slowly. 2^h. Cumuli scattered over the whole sky: a few cirri. 5^h. Detached cumuli: a few cirri.
- 2 20—3 5. 20^h. Clear. 23^h. Cirro-strati edged with cirri and cirro-cumuli: a few cumuli. 2^h. Cumuli. 5^h. Cumuli and a few diffuse cirri.
- 3 20—4 5. 20^h. Cirri nearly linear, proceeding from large cirrous nests: a few specks of cirro-cumuli. 23^h. Detached cumuli: mixed and linear cirri and cirro-cumuli above. 2^h. Cumuli near horizon to S. and E.: sky to N. and W., covered with cirrous haze: cirro-strati and cirro-cumuli. 5^h. Clouds and haze, the sun's rays appear through the haze so as to cast a faint shadow.
- 5 20—6 5. 20^h. Breaking to E. 23^h. Diffuse cumuli. 5^h. Cumuli.
- 6 20—7 5. 20^h. Thick mist: trees definable at about half-a-mile distant. 23^h. Cirri: a few cumuli to S. 2^h. Cumuli: sky nearly covered with cirrous haze. 5^h. Cumuli: sky still hazy, but cirri less distinct.
- 7 20—8 5. 20^h. A few specks of ill-defined cirri to SW. 23^h. Cirro-cumuli and linear cirri. 2^h. A few detached specks of small cumuli, with a streak of cirro-stratus. 5^h. Gusty.
- 8 20—9 5. 20^h. Heavy mist: trees definable at about $\frac{1}{2}$ of a mile. 23^h. A few faint streaks of cirri to S. and SE. 2^h. A speck or two of cirrus to SW. 5^h. Sky on horizon brownish, about 10° altitude, milky, and so up gradually to the deep blue of the zenith.
- 9 20—10 5. 20^h. Principally linear cirri to NE. and SE. 23^h. Chiefly cumuli from S., round by E. to N., edges ragged: nests of cirri. 2^h. From NE. to SE. horizon a mass of ill-defined, flat, watery-

JUNE.

- looking clouds, from which flaky patches rise and are carried to SW. 5^h. Scud covered the sky within an hour.
- d h d h
 10 20—11 5. 20^h. Overcast. 23^h. Indefinable mass. 2^h—5^h. Clear.
- 12 20—13 5. 20^h. Vapoury cumuli. 23^h. Clear. 2^h. Cirro-strati to N. and S.: cumulo-strati to S. 5^h. Principally cumuli to S., and cumulo-strati to N.
- 13 20—14 5. 20^h. Overcast: light mist. 23^h. Cumuli and cirro-cumuli, with cirro-strati: hazy to E. and N. 2^h. Cumuli and cirro-strati: sky hazy: clouds looking electric. 5^h. Cumuli: sky in small patches.
- 14 20—15 5. 20^h. Cumuli and cirri: sky to N. 23^h. Detached cumuli two-tenths: cirri two-tenths. 2^h. Cumuli to S.: cirro-strati to N.: 5^h Cumulo-strati and diffuse cirri.
- 15 20—16 5. 20^h. Cumuli to S.: cirro-strati to N. 23^h. Very ragged cumuli. 2^h. Watery-looking cumuli: sky to NE. 5^h. Cumuli and cirro-strati.
- 16 20—17 5. 20^h. Cumuli: cirri: breaking. 23^h. Cumuli and cirro-strati. 2^h. Cumuli. 5^h. Cumuli: a few cirri.
- 17 20—18 5. 20^h. Cumuli and cirro-strati: a few streaks of blue. 23^h. Cumuli and diffuse cirro-cumuli and cirro-strati: very watery-looking cumuli sailing very low. 2^h. Heavy masses of cumuli moving from SW.: cirro-strati and cumuli above. 5^h. Heavy black cumuli: cirro-cumuli above stationary.
- 19 20—20 5. 20^h. Quite overcast: clouds apparently moving from about SE.: a few drops of rain. 23^h. Light showers. 2^h. Cumuli and nimbi: cirro-cumuli above stationary. 5^h. Watery cumuli or scud: pitch black to S.: electric looking to E.: cirro-strati above scud to E. stationary.
- 20 20—21 9. 20^h. Scud and nimbi. 9^h 30^m. Cumuli and nimbi: cirro-cumuli above stationary. 23^h—0^h. Cumuli and nimbi: cirro-cumuli and cirro-strati: passing showers at 0^h. 1^h. Cumuli and nimbi moving from SSW.: pinnacled cumuli to N.: cirri, &c. above stationary. 2^h—3^h. Beautifully pinnacled cumuli and nimbi: cirri above stationary: looking very electric to NE.: clouds near horizon dark blue, rising gradually to cumuli of the most brilliant white. 4^h 0^m. Cumuli and nimbi: thunder and lightning at about 4^s of interval: heavy rain; drops very large when they first fell, making a circular spot of from 1 to 1½ inch in diameter: hail also about ¼ inch in diameter: lower stratum of clouds moving from about E by N.; upper from SSW.; cirri above stationary; above the upper nimbi there appears a kind of cirrous mass moving slowly in the same direction. 4^h 10^m. The lower stratum appears to move from SE.: storm appears most violent to SW. and W.: very loud peals of thunder: a long chain of nimbi appears to move in a circle, commencing about NE., and going round by S. to NW. 4^h 15^m. The lowest stratum appears to carry the other with it, the hazy cirrous mass still moving, however, to NE.: to the SSW. large masses of white cumuli are occasionally seen through the nimbi, and have a beautiful mezzotint appearance through the rain; they appear stationary. 4^h 20^m—30^m. To the E. masses of cirro-strati are seen: the storm moves off to NW., the lightning is seen very well in that quarter, long forked flashes, extending sometimes from SSW. to NNW. 5^h. Storm moved off to NW., and again brewing in SE., where large dark masses of nimbi are seen rising in the white cirrous haze which covers that part of the sky: light rain: distant thunder. 6^h. Almost an entire mass of nimbi: loud peals of thunder, principally from SSE.: rather heavy rain: thunder about 8^s after lightning. 7^h 5^m. Clouds more in masses than last hour: nimbi: distant thunder, apparently to SE. and SSW., and thence to N. 8^h 15^m. Nimbi, &c. still more broken than last hour: small portion of sky seen in zenith: round the horizon there is that settled appearance so common after a thunder-storm, all the clouds at rest as if becalmed in a moment, and spreading in the lightest tints like yew-tree branches. 8^h 45^m—55^m. Nimbi moving from SE., raining heavily there: a low mass of diffuse cumuli, breaking into a kind of cirro-cumulus, moves slowly from SW. to NE.
- 21 20—22 7. 20^h. Linear cirri: cirro-strati and cumulo-strati stationary: round horizon from N. to SE. detached masses of watery-edged cumuli. 21^h. As at 20^h, with more cumuli rising. 23^h. Cumuli: streaks of cirri round the zenith, crossing at right angles, and pointing NE. and NW.: thin-laced cirri covers four-tenths of the sky. 0^h 5^m. Cumuli 7 parts; reticulated cirri 2. 2^h. Cumuli: very scattered streaks of cirrus, seen principally to S. 3^h. Cumuli: cirrous haze to S.: fibrous cirri to E., pointing WNW. 5^h. Cumuli moved off to N.; a few to S.: the greater part of the sky covered with very thick cirrous haze (very thick to E.) and cirro-cumuli. 6^h 40^m. A few cumuli round horizon: remainder of the sky covered with common and linear cirri lying in all directions, the greater part having their origin to SE., and lying in a sort of curl towards E.
- 22 7—23 9. 10^h. Linear cirri to NE., and cumuli to S., cirro-strati to NE. 11^h. Clouds on horizon: clear

JUNE

- overhead. 12^h. Cumuli to S. 13^h. Principally large cirro-cumuli. 15^h. Linear cirri, chiefly to E. 16^h. Linear cirri and pure cirri having the concave side to S. 17^h. Linear cirri to E. 2^h. Cumuli principally on horizon: cirri. 3^h. Cumuli round horizon, but principally cirri scattered over the sky: thick cirrous haze to S. and SW. 4^h. Cumuli on horizon: remainder of the sky covered with cirrous haze: very thick to S. and SE.: the sun's rays scarcely penetrate.
- d h d h
23 20—24 5. 6^h. Cumuli. 8^h—9^h. Scud.
20^h. Cumuli moving quickly: sky very hazy to E.: linear cirri to S. stationary: some of the cumuli very low. 23^h. Cumuli and haze: linear cirri above: clouds watery and electric-looking: a few drops of rain. 2^h—5^h. Cumuli moving rapidly: linear cirri: cirro-cumuli and cirro-strati above stationary: cirrous haze to SSW. rising with cumuli.
- 24 20—25 5. 20^h. Cumuli in different strata: cirro-cumuli. 23^h. Scud. 2^h. Scud: light rain. 5^h. Heavy rain.
- 25 —26. (Sunday). The wind changed in the morning from SW.: wind very strong on Saturday night and Sunday.
- 26 20—27 8. 20^h. Small watery ragged cumuli moving quickly: a long compact body of cirro-cumuli over two-tenths of the sky. 23^h—2^h. Cumuli. 5^h. Cumuli, some of them spinning out into cirri and beautiful cirro-cumuli, which, in some places, are formed of little mats of cirrus, fanning off to the edge, so as to become mottled or waved cirri: to the E. is one mass of cirrus, in which the lines lie NW. and SE., in other places, to the S. and W. it gets quite thick, so that the separation can scarcely be distinguished. 8^h 20^m—25^m. Most beautiful cirro-cumuli here and there in thick masses, fine near the edges, with bright blue between, all radiating from NW. to zenith, and from SE. where they almost become cumuli.
- 27 20—28 8. 20^h. Scud: light rain. 23^h. Scud. 5^h. Smart shower. 8^h 30^m. Masses of scud moving very rapidly from SW., shewing occasionally speckled or frosted-looking cirro-cumuli above stationary.
- 28 20—29 8. 20^h. Ragged cumuli or scud very low and moving quickly: cirro-cumuli and cumuli above. 23^h. Scud and cumuli moving quickly: cumuli on horizon: linear cirri in zenith either stationary or moving very slowly. 2^h. Scud. 5^h. Cumuli and scud: long streaks of cirri pointing E. and then S.: clouds electric-looking to E.: the quantity of clouds variable. 8^h 35^m. Watery-looking scud edged with cirro-cumuli: large dense masses of cirro-stratus: cirri to S.: the clouds extend far, having large open spaces within: many of the clouds like large masses of cedar branches.
- 29 20—30 5. 20^h. Cumuli creeping along horizon from W.: linear cirri above cumuli pointing E.: many patches of watery cumuli rising from about W., pass over near the zenith moving towards ESE.; when they approach the meridian they break up into cirrous edges, as if the mass were unraveling itself, and then they get quite detached, some parts appearing motionless, some moving quicker than others, and often taking very different directions, some proceeding nearly to E., others moving off to S. or SSE., till at last they are altogether dissipated; to the SE. patches are occasionally seen forming just as the others vanish; the clouds near the horizon do not appear to pass through this change. 23^h. Cumuli, which appear to move from NW. or NNW., but there still appears to be two currents, the upper from about W., and the lower from about N; when near the meridian there is the same tendency to dissipate. 2^h. Cumuli: the sky hazy: some of the cumuli very ragged. 5^h. Cumuli: cirrous haze.
- 30 20—30 23. 20^h. Cumuli and cirro-cumuli: linear cirri to NE. 23^h. Cumuli: hazy to E.: clouds moving very slowly.

JULY.

- 1 2—1 5. 2^h. Clouds and haze: cumuli very hazy to E. and S.: electric-looking. 5^h. Clouds and haze: thick cirrous haze to W. and S.: cumuli and cirri: low clouds, like patches of scud moving slowly: very black to E.: haze so thick to W. that the sun's rays scarcely project a shadow; his rays appear like fine cirri in the cirrous haze; some portions of the cirri might be termed etched, from their scratchy appearance.
- 1 20—2 5. 20^h. Cirri and nimbi: light rain. 23^h. Cumuli and nimbi. 2^h. Cumuli and nimbi: rain: small patches of sky. 5^h. Cumuli and cirro-cumuli.
- 3 20—4 5. 20^h—2^h. Scud. 5^h. A kind of thick haze and cumuli on horizon.
- 4 20—5 5. 20^h. Nimbi and cumuli: other clouds above: light rain. 23^h. Cumuli: nimbi and scud: a few patches of sky: immense masses of clouds moving rapidly from about SW.: light rain. 2^h. Watery

JULY.

- cumuli : cirri and masses of thick cirro-strata above : to the SE. is a large hazy mass of clouds which becomes almost cirrous on the edges, and is cumuli on the top. 5^h. Cumuli moving rapidly : linear cirri above stationary.
- 5 20—6 5. 20^h. The sky covered with a thick cirrous haze, through which a few patches of sky are seen to W. : to the NE. dark cirro-cumuli are seen below the haze, and linear cirri here and there : a few specks of scud or loose cumuli rise from about NNW., and mostly creep along the S. horizon ; a few along the N. horizon ; the haze and other clouds appear stationary. 23^h. A great portion of the clouds are patches of cirrous haze ; there are also cirro-cumuli, linear cirri, scud and cumuli. 2^h. Principally ragged cumuli : linear cirri above : hazy cirri to N. and E. 5^h. Cumuli : a few linear cirri to NE.
- 6 20—7 9. 20^h. A confused mixture, apparently breaking to E. 23^h. Sky covered with a thick cirrous haze : quite milky : cumuli on E. and N. horizon. 2^h. Haze as before, but more cumuli ; the sun projects a faint shadow. 5^h. Scud and haze : rain. 8^h 45^m. Clouds like puddledock : occasional showers.
- 7 20—8 5. 20^h. Cirro-cumuli : large masses of ragged cumuli rising from SW. : linear cirri to N. 23^h. Cirro-cumuli moving slowly : immense piles of cumulo-strati of great length : dark to SSW., where there appears the nucleus of a storm : patches of scud with the cumuli. 2^h. Cumuli and nimbi rising from SSW. : occasional showers. 5^h. Cumuli, nimbi, and cirrous haze : clearing to S. : occasional smart showers.
- 8 20—9 5. 20^h. Large masses of watery cumuli rolling along slowly : in the E. the rounded masses are inclined to the horizon at an angle of 45°, and have a most picturesque appearance : cirro-cumuli seen above : a few patches of sky. 20^h 10^m. Clouds 9.5. 23^h. Large masses of cumuli below, while there is a large kind of cirro-cumuli above : the cumuli have great fantastic forms, and are much in ranges : patches of sky. 2^h. Cumuli and large cirro-cumuli : cumuli in ranges round horizon : about an hour ago beautiful cirro-cumulo-strati were seen. 5^h. Cumuli, with large cirro-cumuli and cirro-strati round horizon ; the cumuli are lowest and move quickly, the others are stationary.
- 10 20—11 5. 20^h. Scud : heavy rain : on the evening of the 10th scud was moving from about W., the lower current being more rapid than the upper. 23^h—2^h. Scud : heavy rain. 5^h. Cumuli and scud : clouds more broken : a little sky in zenith : showers lately : the air feels warm.
- 11 20—12 5. 20^h. Cirri and cirro-strati to E. : the cirri are on the border of the mass of cirro-strati, and in some places look like foam on a wave ; they have their concavity towards the S. : watery-looking cumuli rising from NNW. 23^h. Cumuli. 2^h. Cumuli : clouds in detached masses over the whole sky. 5^h. Cumuli, principally on horizon : a few linear cirri to E.
- 12 20—13 5. 20^h. Cumuli and scud : rain : sunshine half-an-hour ago. 23^h. Loose cumuli and nimbi moving quickly : cirro-cumuli above : showers around. 2^h. Cumuli and scud : cirri and cirrous haze above. 5^h. Cumuli and scud.
- 13 20—14 5. 20^h. Cumuli and scud : linear cirri and cirro-strati to N. and S. 23^h. Ragged cumuli and cirrous haze. 2^h—5^h. Cumuli.
- 14 20—15 10. 20^h. Hazy cirri to N., E., and S. : cirro-cumuli and cirro-strati to W. : two or three masses of ragged cumuli. 23^h. Chiefly linear cirri spread in all directions, almost becoming haze to N. and E. : cirro-cumuli and cumuli moving slowly. 2^h. Cumuli : woolly cirro-cumuli and cirri : fish-backed cirro-strati. 5^h. Flat cirrous-edged cumuli moving very slowly from about WNW. 9^h 35^m. Strange looking grey cirro-cumuli creeping up from SW. near to the zenith, and E. and W. of it, sending out small ragged creepers, like the branches of a weeping willow ; the sky to the S. of the zenith is quite covered with this, which becomes quite thick to S., and like irregular cirro-cumuli at 45° alt.
- 15 20—16 5. 20^h. Clear : a small patch of linear cirrus to W. : hazy to E. 23^h. Cumuli dispersed over the sky, except to N., from which a compact mass extends to ESE. 2^h. Cirrous masses, from which the cirri diverge in all directions ; the greatest mass is to NW. 5^h. Cirri in fantastic forms, springing from a thick nucleus to W., and tossed out in all directions ; there is a long feather of cirrus extending 25° to 30° : linear cirri to SW.
- 17 20—18 9. 20^h. Sky covered with cirrous haze and linear cirri, which appear stationary, while masses of loose cumuli or scud moving slowly from about E. cover seven-tenths of the sky ; the sun's rays just project a faint shadow on paper ; the sky was covered by a confused mixture of cirri on the 17th. 23^h. Cirrous haze and cirro-strati as before, but more cumuli or scud ; the haze seen through the openings. 2^h. Cirrous haze as before : cumuli and cumulo-strati. 5^h. Less haze : a few cirro-

JULY.

- cumuli, but the greater part of the sky is covered by scud and cumuli. 8^h 40^m. Seven-tenths of the sky covered with dark heavy clouds like nimbi (but no rain), moving from ESE., while in the higher strata are cirro-cumuli and linear cirri stationary; the cirrus becomes like thick cobwebs to W., while it is quite black to S.: scud below, which appears to move quickest: wind increasing.
- 18 20—19 5. 20^h. Scud. 23^h. Scud, clouds very thick: wind more in gusts. 2^h. Scud moving rapidly from ENE.: cirro-cumuli above moving slowly in the same direction. 5^h. Scud: occasional patches of sky.
- 19 20—20 5. 20^h. Light mist, tendency to drizzle. 23^h—5^h. Clouds moving from NE. 5^h. Light drizzle.
- 20 10—20 23. 11^h. Breaking to N., where there are considerable patches of sky. 17^h. Cirro-cumuli. 18^h. Cirro-cumuli and linear cirri. 19^h. Loose cumuli and a few linear cirri to N. 20^h. Cumuli: haze on SE. horizon. 23^h. Loose cumuli moving from N by E., and another current from ENE., a few cirro-cumuli above, apparently stationary.
- 21 0—21 10. 0^h—2^h. Loose cumuli. 3^h. Cumuli and scud, some with cirrous fringes; one current carries clouds from N by E., and another from NNW. 4^h. Loose Cumuli. 9^h. From N. to SE., one thick pile of craggy cumuli, lighted by the setting sun, giving all the appearance of snowy Alps tinted by his glowing rays. 10^h. Large mass of loose cumuli moving from about NNE.
- 21 20—22 5. 20^h. A mass of loose cumuli: sky to NW. 23^h. Loose cumuli: sky principally to NW. 2^h. Loose cumuli, better defined than before. 5^h. Detached cumuli to SE.
- 22 20—23 5. 20^h. Undefinable mass. 23^h. Clear. 2^h. A few specks of cumuli to SE. and N. 5^h. Detached cumuli to S. and N.
- 24 20—25 5. 20^h. Flaky cumuli. 23^h. Cumuli: patches of hazy sky. 2^h. Cumuli: sky hazy. 5^h. Cumuli, &c., hazy.
- 25 20—26 5. 20^h. Loose cumuli on horizon: large cirro-cumuli above and in zenith: clouds breaking. 23^h. Heavy dark cumuli looking electric to SE.: upper clouds moving very slowly from about NNE.; lower current rather quicker from SSE. 2^h. Heavy black cumuli from about SE.: upper current from W.: white towering masses of cumuli: a few drops of rain. 5^h. Cumuli and cirro-cumuli, the latter principally to E.: light shower since last observation.
- 26 20—27 5. 20^h. Loose cumuli and cirro-cumuli: linear and other cirri and cirrous haze to N. 23^h. Very like an approaching storm: a mixture of cirri and cirrous haze: loose and well defined cumuli; the cumuli are seen as if at rest in the bluish gray mass to E. and W.; the sky has altogether an indescribable appearance. 5^h. Nimbi and more heavy black cumuli: rain to E.: scud creeping up slowly from W.: cumuli and cirri to N.: wind just sprung up: a patch of sky to N.
- 27 20—28 5. 20^h. A sort of blackish-blue mixture, in some places like cedar branches: a few cumuli seen: a few drops of rain: scud lowest, moving from about NNW. 23^h. Nearly as before: more long strings of loose cumuli floating from W.: clouds to NE. lying in all directions: occasional patches of sky. 2^h. More muddled than before. 5^h. Cumuli principally to E.: patches of cirrous haze or cirro-stratus edged with cirri: looking stormy to E.: at 4^h the clouds moving from E., and a smart shower of rain.
- 28 20—29 7. 20^h. Loose cumuli, quantity variable. 23^h. Heavy loose cumuli: linear cirri above: breaking to N. 2^h. Cumuli: linear and woolly cirri above, both moving from N. 5^h. Ragged edged cumuli: cumulo-strati to N. 6^h 45^m. Quantity of clouds 5.5: a kind of cirro-cumulous cirri; the cirri are all matted and frizzled, moving from N., but having a sort of lee-way from E.: a lower current from W. carries a mass of smoky cirrous scud, which appears to have a lee-way to S.: masses of cirro-strati rising from SW.: on the NE. and SE. horizon are beautiful cumuli and cumulo-strati.
- 29 20—30 5. 20^h. Three-tenths of cumuli to E.: four-tenths of fine cirri in zenith and to W.: a few cirri to SW., apparently moving from W., the other clouds moving from N. 23^h. Rather loose-edged cumuli. 2^h. As before: a kind of snowy cirri above: sky in patches. 5^h. As before: patches of cirrous haze: very thick in zenith and to S.: sky principally on E. horizon, some to N.
- 31 20—31 23. 20^h. Linear cirri to N. and E. 23^h. Cumuli and linear cirri on horizon: small patches of loose cumuli moving from SSW. across the zenith.

AUGUST.

- 1 2—1 5. 2^h. Cumuli principally to E. and S., but moving across the zenith from SW. 5^h. Cumuli nearly as before.

AUGUST.

- d h d h
1 20—2 5. 20^h. Sky covered with cirri : a few cumuli to N. 23^h. Haze and cumuli. 2^h. Sky hazy : clouds misty : cumuli. 5^h. Cirri : sky very hazy, especially on horizon : a few specks of cumuli to SE. and NE.
- 2 20—3 5. 20^h. Largest kind of cirro-cumuli. 23^h. Cumuli and cirro-cumuli : hazy to E. 2^h. Heavy black and white cumuli : scud below : a few drops of rain ; very hazy to E. : a few cirri : electric and rainy-looking. 5^h. Cumuli and scud : haze on horizon : patches of hazy sky.
- 3 20—4 5. 20^h—23^h. Scud moving rapidly. 2^h. Cumuli and scud : sky in zenith. 5^h. Cumuli and scud : cirri above.
- 4 20—5 5. 20^h. Scud. 23^h. Scud : occasional patches of sky and gleams of sunshine : very light drizzle. 2^h. Scud : slight drizzle. 5^h. As at 2^h ; the upper covering of clouds is a dim homogeneous gray : occasional patches of sky.
- 5 20—6 5. 20^h. Fine linear cirri radiating from SSW. and NNE. : mottled cirri to E. 23^h. Reticulated cirrus, which becomes cirrous haze to E. : loose cumuli and cumulo-strati below. 2^h. Detached cumuli round horizon : cirrous haze above. 5^h. Detached masses of cumuli : cirri and cirrous haze above ; the cirri waved in all directions.
- 7 20—8 5. 20^h. Hazy : scud : clouds like cedar branches : very thick to E. 23^h. Loose cumuli or scud. 2^h—5^h. Heavy cumuli : very hazy to E.
- 8 20—9 5. 20^h. Scud : cumuli on E. horizon : hazy to E. 23^h. Loose cumuli moving quickly : woolly cirro-cumuli : linear cirri and cirrous haze. 2^h. As before ; showers. 5^h. Linear and woolly cirri and cirrous haze over $6\frac{1}{2}$ tenths : scattered cumuli.
- 9 20—10 5. 20^h. Hazy cirrous clouds : linear cirri : cirro-cumuli-strati and woolly cirro-cumuli. 23^h. Clouds scattered : as before, but a few small patches more nearly approaching to small cumuli. 2^h. Very hazy and electric-looking : haze and cumuli ; the cumuli not much rounded and rather flat. 5^h. Nimbi : thunder, first heard about 2^h 30^m to the SSW., whence black cumuli arose ; it gradually came nearer, moving along W. horizon : rain began to fall at 3^h 0^m, which has continued since ; the storm has now worked round to NE. or E. ; the flashes of lightning are not frequently seen ; the storm appeared about 7^h to have ceased ; it was, however, only a lull for an hour, when it again commenced more violently than ever, the lightning being often vivid ; the distance of the thunder-clouds being from $\frac{1}{3}$ of a mile to 5 miles. The magnets have been nearly stationary since the storm began ; this fixedness of their positions during thunder-storms has been observed three times now.
- 10 20—11 5. 20^h. Scud. 23^h. Hazy clouds and loose cumuli, principally on horizon. 2^h. Loose cumuli moving quickly : linear cirri and loose cirro-cumuli above stationary. 5^h. Cumuli moving quickly : a few patches of matted cirri above, apparently stationary.
- 11 20—12 5. Scud. 20^h. Clouds moving quickly : to the E. there is a large bank of bluish-gray clouds stationary. 2^h. Sky on NE. horizon.
- 12 20—13 5. 20^h. Misty scud, very low and moving very quickly : a great quantity of matted and woolly cirrous clouds above ; the scud is so thin that the cirrous clouds can be often seen through it. 23^h. Nearly as before, but the sky is more in detached patches. 2^h. Loose cumuli moving quickly : above are fine mottled, vertebrated, etched, reticulated, and hazy cirri. 5^h. Loose cumuli, as before, but more hazy : cirrous clouds and cumuli stationary : great banks of dense cirro-strati.
- 14 20—15 5. 20^h. Thin scud : pectinated cirri above ; the fibres of the cirri pointing NNW. and E. ; the cirri appear to have a sort of leeway to E. or SE. : a few cirro-cumuli. 23^h. Hazy and flame cirri, some pointing NW., and some pointing SW. : hazy cirri to NW., from which spring the greater portion of the flame cirri : a few cumuli on horizon, and scud rising from SW. 2^h. Cumuli : cirri above, lying in two directions ; the flame cirri rising from WNW., and linear cirri pointing NNE. and NW. ; the cirri are gathered together in some places into little foamy patches : very electric-looking to S. : frequently the quantity of clouds is only seven-tenths. 5^h. Cumuli and cirro-strati to W. : thick cirrous haze and patches of scud to S. and SE. : cirri of various kinds to the E. : cirro-strati and piles of white cumuli beyond : haze and cirri lying in different directions : cirri lying chiefly from NE. to SW. and SE. to NW. : scud.
- 15 20—16 5. 20^h. Loose cumuli : a kind of cirro-cumuli above stationary. 23^h. Loose cumuli : sky on NE. horizon. 2^h. Loose cumuli, much detached and moving very slowly : sky all in little patches. 5^h. Scud : patches of sky on NE. horizon.
- 16 20—17 5. 20^h—23^h. Homogeneous : a tendency to break at 23^h. 2^h. A few patches of scud moving rather quickly : linear cirri above. 5^h. Cumuli : large cirro-cumuli and linear cirri.

AUGUST.

- d h d h
 17 20—18 5. 20^h. Cirrous haze: cumulo-strati and cirro-strati: loose cirro-cumuli. 23^h. Vertebrated cirro-cumuli, &c., pointing from S. to N. 2^h. Haze: cirri and cumuli: thermometer in the sun 106°-8. 5^h. Common and craggy cumuli: linear cirri pointing from W. to E.: cirrous haze: a few patches of scud.
- 18 20—19 5. 20^h. Loose cumuli: hazy above: thunder to E. before and after this time, and was also heard during the night. 23^h. Cirrous haze and linear cirri. 2^h. Haze: cumuli and rather large cirro-cumuli. 5^h. Haze: nearly homogeneous.
- 19 20—20 5. 20^h. Loose cumuli: cumuli on horizon: linear cirri. 23^h. Scud: a perceptible drizzle. 2^h. Haze: scud: dull grayish-blue appearance: stormy-like. 5^h. Haze and nimbi rising from SSW. like a fine sheet: clouds like cedar branches: slight drizzle.
- 21 20—22 5. 20^h. A kind of mottled gray mass, part of it like loose cirro-cumuli: sky on NW. horizon. 23^h. Cirro-cumuli, but not well-defined: in some places to N. the cirro-cumuli are like the rippled sand on the sea-shore, but are brownish on the ridges, and white in the hollows. 2^h. A very heterogeneous mixture, small patches of the sky here and there. 5^h. Nearly as before, but denser.
- 22 20—23 5. 20^h—23^h. A few loose detached cumuli: linear cirri. 2^h. Woolly cirro-cumuli of all sizes: cumuli: sky hazy near horizon; dense to S. and SE. 5^h. Cirro-cumuli lying in strata from SSW. to NNE., gathered in many places into dense nuclei; to the E. are long strata of clouds, probably cirro-strati, with rough edges, lying from SE. to NNE.: a few patches of black scud sailing low from about SSW., and lying in lines in that direction like the cirro-cumuli.
- 23 20—24 5. 20^h. Scud: light drizzle. 23^h. Like buttermilk agitated, all as if stationary; like cedar branches to N. 2^h. Nearly as before: occasionally light showers. 5^h. More broken than before: a few patches of sky: detached cumuli lying very low.
- 24 20—25 5. 20^h. A few linear cirri. 23^h. Loose cumuli: cumuli higher, moving much slower. 2^h. Cumuli. 5^h. Loose cumuli: linear cirri.
- 25 20—26 5. 20^h. Scud: various kinds of cirro-cumuli above: linear cirri here and there. 23^h. Loose cumuli: cirro-cumuli. 2^h. A few patches of scud moving from NE.: cumuli, &c. above, moving very slowly from about SSW. 5^h. Loose cumuli: cirro-cumuli.
- 26 10—27 10. 10^h—20^h. Scud. 21^h. Scud: a few patches of sky: cirro-cumuli seen above. 22^h. Scud: sky in patches. 2^h. Cumulous scud: cirro-cumuli above. 6^h. Loose cumuli and patches of scud, all nearly stationary. 7^h. As at 6^h: a few patches of etched scud lying low. 8^h. Loose cumuli: 9^h. Cirro-cumuli.
- 28 20—29 5. 20^h. Scud: light mist or drizzle: the vane pointing N. but no wind. 23^h. Loose cumuli moving rather quickly: sky in detached patches. 2^h. Cumuli. 5^h. Detached cumuli round horizon.
- 29 20—30 5. 20^h. Scud, like cedar branches to E. and N.: clouds above stationary. 22^h 10^m. The clouds are principally cirro-cumuli, lying in lines from S by W., with scud below moving from NE. 23^h 40^m. Haze clearing off, and a long line of ill-defined cirro-cumuli lying N. and S., and moving from S by W.: detached cumuli moving more slowly than before: haze in all parts of the sky, excepting the zenith: some clouds are moving from NNW. 0^h. Principally cirrous haze, about 1½ tenths of cumuli: streaks of pure blue sky to E.: stormy-looking. 2^h. Haze, 2½ tenths of cumuli: the sun projects a visible shadow. 5^h. Diffuse cirro-cumuli and haze: watery-looking cumuli on horizon: sky appearing to W.
- 30 20—31 5. 20^h. Clear. 23^h. Detached cumuli, rather loose on the edges: linear cirri above. 2^h. Cumuli: linear cirri above, pointing first from WNW., then from W by S., moving from NW.: immense piles of white cumuli moving very slowly. 5^h. Sky principally covered with cirrous haze and linear cirri: cumuli moving very slowly: loose cumuli rising from SW., where it is very black: well-defined cumuli on NE. horizon.
- 31 20—31 23. Scud. 20^h. Other clouds above stationary. 23^h. Occasional showers.

SEPTEMBER.

- 1 2—1 8. 2^h. Scud: loose cumuli above moving slowly: linear cirri highest pointing from W by N. 5^h. Scud: cirrous haze, &c. above, stationary or moving very slowly. 8^h. The sky presents a very strange appearance: large dense masses of scud like smoke are creeping along N. and S. horizon from westward; thin fleecy masses of the same move quickly across the zenith from W.: near the NW., where the sun is setting, above the scud are masses of cirro-strati, tinged with white edges,

SEPTEMBER.

- and seen in the dark grayish-blue beyond, with a patch or two of the brightest blue sky; the sky is just seen through the scud in the zenith and to E.; it is difficult to tell whether there is a bluish-gray cloud or only the sky seen through the scud: raining: about this time the ends of a double rainbow were seen.
- 1 20—2 5. Scud. 5^h. Small patches of greenish sky to SSE.: some low patches of scud from SW.: drops of rain.
- 2 20—3 9. 20^h. Thin scud sailing very quickly; denser near horizon: ragged cirro-cumuli above moving very slowly; sky in zenith. 23^h—5^h. Scud: light rain at 5^h. 3^h 40^m. Three different currents of air observed at present; the highest carries loose patches of scud from W by S.; the next lower, larger and darker masses from NW by W.; and the lowest, thin vapoury patches of scud from NNE.; the direction of the wind at the surface is NNE $\frac{1}{2}$ E. (SW. at 5^h.); the greatest mass of clouds is from NW by W.; the upper current is very slow; in a few minutes the lowest current nearly ceased, it was previously the swiftest: quantity of clouds 9.0.
- 4 20—5 5. 20^h. Linear cirri and cirrous haze: thin cirrous nests. 23^h. Scud, &c.: cirrous haze seen near horizon: clouds moving very slowly. 2^h. Thick scud. 5^h. Scud: other clouds above stationary, or nearly so.
- 5 20—6 5. 20^h. Scud: cirro-cumuli. 23^h. Loose cumuli and scud; the cumuli moving slowest. 2^h. Cumuli and scud. 5^h. Large mixed cirro-cumuli and cumuli: sky on NE. and NW. horizon, on the NE. it is light green; clouds black to SE.
- 6 20—7 5. 20^h. Linear cirri radiating across the whole sky in feathered masses from the W. point of the horizon; on the E. horizon the linear cirri lie N. and S. parallel to the horizon; the feathers of cirri extend from W. to 30° from E. 23^h. Loose cumuli moving slowly: cirro-strati higher, moving much slower: sky in patches: detached cumuli and cirrous haze on E. horizon. 2^h. Loose cumuli: cirrous haze and cirro-strati seen above stationary: sky in detached patches. 5^h. Thick cirrous haze, through which the sun scarcely projects a shadow: thick banks of dark clouds here and there: the clouds have a perceptible motion from S. by E.: stormy-looking.
- 7 20—8 5. 20^h—23^h. Scud: light rain. 2^h. Scud; the sun's rays penetrating some openings. 5^h. Loose cumuli and scud: linear cirri and cumuli above.
- 8 20—9 5. 20^h. Scud: homogeneous: light drizzle. 23^h. Scud. 2^h. Scud: cirro-cumuli: cirro-strati, like sheets of white paper to E.: dense cumuli round horizon. 5^h. Detached masses of scud or loose cumuli: pinnacled cumuli and other clouds above moving much slower: cirro-strati on horizon: very black to NW.
- 9 20—10 5. 20^h. Thin scud: cirro-cumuli above. 23^h. Scud: cumuli, &c. above. 2^h. Scud and cumuli: cirri like flames, radiating towards NW. and W. 5^h. Scud and loose cumuli: cirro-cumuli above, moving very slowly.
- 11 20—12 5. 20^h. Scud: cirrous haze near S. horizon; a few minutes before this the sky was overcast; clearing off rapidly from W.: thick and dull to E.: wind rising: in a few minutes the sky was again quite overcast. 23^h. Scud: sky on NW. and NE. horizon, where cumuli are rising. 2^h. Cumuli: cirrous haze on S. horizon. 5^h. Cumuli to W.: fine linear cirri, like pencils of the finest hairs, the root being to E., pointing E. and W., and reaching over 75° in length from E. to past the zenith; they are visible over the whole sky, lying quite parallel to each other, and apparently springing from a kind of reticulated cirrus, which forms a portion of the circumference of a circle, whose centre is in the E. and radius 20°; the roots of the cirri appear to move on this circumference, the cirri apparently describing a greater circle: cumuli moving slowly.
- 12 20—13 5. 20^h. Very thick; appearing to radiate from N. and S.: cirro-cumuli in the zenith, and thick cirro-strati to E. 23^h. Nearly homogeneous: some small patches of scud. 2^h—5^h. Large diffuse cirro-cumuli: specks of sky here and there: the sun's rays through the interstices of the cirro-cumuli project a faint shadow.
- 13 20—14 5. 20^h—23^h. Scud: nearly homogeneous: patches of sky at 20^h. 2^h. A strip of sky on NE. horizon. 5^h. Patches of sky to SE. and S.: cumuli on ESE. horizon.
- 14 20—15 5. 20^h. Thick mist, rendering trees invisible $\frac{1}{4}$ of a mile distant: large loose cirro-cumuli. 23^h. Cumuli and large cirro-cumuli; cumuli lower and moving quicker than the cirro-cumuli. 2^h. Loose-edged cumuli: sky in patches. 5^h. Very large cirro-cumuli: very black to NNW: sky seen between the cirro-cumuli.
- 15 20—16 5. 20^h. Cirro-cumulous scud: different kinds of cirro-cumuli above: linear cirri still higher. 23^h. Cirrous haze: scud and cumuli: linear cirri to E. with small patches of cirro-cumuli: the

SEPTEMBER.

- sun's rays project a pretty distinct shadow. 2^h. Nearly as before: haze more above horizon: large cirro-cumuli; a few patches of sky. 5^h. Haze: linear cirri: cumuli.
- 16 20—17 5. 20^h. Cumuli or scud: cumuli and cirro-cumuli to E., lying like islands in the ocean: haze on horizon. 23^h. Linear cirri generally becoming haze: scud moving rapidly: cumuli on horizon: the sky has a troubled appearance. 2^h. Scud: light rain. 5^h. Loose cumuli and cirro-cumuli from S by W.: cumulous scud, sailing low from W by S., and three times quicker than the clouds above; it is rather curious that the highest clouds move in the same direction as the wind on the surface, while the lower clouds are from W by S.; these motions are most evident, as the clouds are considerably detached.
- 18 20—19 5. 20^h—23^h. Scud. 2^h. Loose cumuli; the current from NNW. just disappeared, the upper current from WSW. 5^h. Cumuli and loose cirro-cumuli from SSE.
- 19 20—20 5. 20^h. Linear cirri to NE.: cirro-cumuli to W.: cumuli and scud to S. 23^h. Cumuli on horizon: cirrous haze on E. horizon. 2^h. Loose-edged cumuli: cirrous haze to E.: wind rising. 5^h. Detached cumuli moving slowly: linear cirri to NE.
- 20 19—20 23. 19^h. A homogeneous mass of clouds: light mist. 20^h. As at 19^h: heavy mist: rain at 20^h 30^m. 21^h. Clouds homogeneous: smart shower. 22^h. Scud; some patches moving very slowly from about N., some seen to S. moving nearly from W.: light rain. 23^h. Rain clouds: scud rising from about E. and N.: sky on E. and S. horizon: black to N.: smart shower: the sun shining through thin cirrous clouds: the rain clouds are not observed to move: the scud only appears to move from between N. and E.
- 21 0—21 23. 0^h. Low detached patches of scud rather quickly from NNW.: large cirro-cumuli to N., very slowly from about W.: cirrous clouds highest, and apparently stationary: cumuli on E. and N. horizon: the scud has two motions, the upper current from N., the lower from WNW., so that it has the appearance of foam on a whirlpool; in a few minutes some patches are moving from NNE.; these are the principal motions, but some patches are seen moving from SSE., and at 0^h 15^m some remain stationary. 1^h. Cumuli and scud, the latter from NNE., S.W., and WNW., the same eddying of the currents as at 0^h; they sometimes stop about the zenith and change their course; the lowest and most powerful current is from NNE. 2^h. Loose and other cumuli from about NE.: cumulo-strati on horizon. 3^h. Scud from S. and from N., but changing the direction every few minutes: cumuli round horizon; the principal motion is from S.; sometimes the upper clouds are from S., sometimes the lower; they are sometimes from E.: linear cirri to SW.: flame cirri highest, radiating and moving from S. to N. 4^h. Scud from N by E. and from NE.: cirro-cumuli above, very slowly from S. 5^h. Loose cirro-cumuli from NW., better defined and stationary above; some moving from SSE. slowly: cumuli round horizon, which to N. are gray and watery-looking. 6^h. Scud and large loose cirro-cumuli; the motions are so small, that it is impossible to determine them: cumuli round horizon. 6^h 30^m. Thin scud from NW.: thunder heard to S. 7^h. Cirro-cumuli in zenith: scud on horizon, motion very small, apparently from NE. 8^h. Principally cirro-cumuli. 9^h. Cirro-cumuli to E.: heavy cumuli to W.: clear on S. horizon. 10^h. Cirro-cumuli in zenith: cumuli on horizon: black to SW. 11^h—16^h. Scud and loose cirro-cumuli: cumuli on NE. horizon at 15^h. 17^h. Large cirro-cumuli and cumuli. 18^h. Scud: cirrous haze above. 19—20^h. Scud from NE. lowest, the highest from SSE.: several patches of sky seen, but covered with thin cirrous haze. 21^h. Principally cirrous haze: the sky has a film of linear cirri over it: a few patches of scud quickly from N. and very low. 22^h. Scud. 23^h. Heavy clouds on horizon: clouds breaking up.
- 22 0—22 10. 0^h. Heavy clouds on horizon: clouds breaking. 1^h—2^h. Principally cirrous haze: scud from N.: the sun's rays project a faint shadow. 3^h—4^h. Cirrous haze: scud and cumuli: a few drops of rain at 4^h. 5^h—6^h. Rain. 7^h. Scud: light showers. 8^h. Ceased raining. 9^h. Smart shower. 10^h. Heavy rain.
- 22 20—23 5. 20^h. Scud: occasionally drops of rain: patches of sky. 23^h. Loose cumuli and scud, the scud lowest and quickest. 2^h. Scud: cumuli: cirrous-like clouds highest. 5^h. As at 23^h.
- 23 20—24 5. Scud. 20^h. Moderately heavy rain. 23^h. Heavy rain. 2^h. Breaking: wind just risen: occasional peeps of sky. 5^h. Large cirro-cumuli seen above the scud.
- 25 20—26 5. 20^h. Thin scud, which scarcely obscures the sky and the higher clouds: light rain. 23^h—24^h. Scud: dense fine rain (Scotch mist). 5^h. Scud: like buttermilk to N.: gray cumuli on N. horizon, moving along towards W.
- 26 20—27 5. 20^h. Scud and loose cumuli moving very slowly: sky to NW.: nimbi to E. 23^h. Loose

SEPTEMBER.

- cumuli from NE by N. : another current from ENE., which appears to be edging round by S.
 2^h. Loose cumuli from N by E., apparently another current from about E. : cumuli on E. horizon ;
 sky there and in zenith. 5^h. Scud : loose cumuli.
 27 20—23 5. 20^h. Scud : clouds breaking. 23^h. Scud : light rain. 2^h. Scud : sky in zenith and to N.
 5^h. Scud : cirro-cumuli.
 28 20—29 5. 20^h. Loose cumuli. 23^h. Scud : sky to W. with cumuli : rain to E. : a smart shower in a few
 minutes. 2^h. Loose cumuli. 5^h. Well-defined and loose cumuli : scud very low : part of a rain-
 bow to NE.
 29 20—30 5. 20^h. Cirro-cumuli moving slowly from ENE., lying in a stratum from NNE. 23^h. Cumuli,
 detached and in ranges on horizon. 2^h. Loose cumuli moving slowly. 5^h. Loose and well-defined
 cumuli : cumulo-strati on horizon.
 30 20—30 23. 20^h. A dense mass round horizon, like cirro-cumuli stratified on the edges : a long line of loose
 cirro-cumuli moving across the zenith ; above this are patches of flame cirri. 23^h. Cumuli and
 large cirro-cumuli : sky to W., and through the interstices of the cirro-cumuli, which become quite
 thick to E.

OCTOBER.

- 1 2—1 5. 2^h. Scud, and two currents of loose cumuli. 5^h. Large cirro-cumuli.
 2 20—3 5. 20^h. Thin scud : other clouds higher : sky to N. 23^h. Scud and loose cumuli : patches of
 sky to S. 2^h. Scud and a kind of cirrous haze : ragged cumuli : patches of sky to N. and S. :
 the sun projects a strong shadow through the haze. 5^h. Cumulo-strati and scud : linear cirri above
 all to S.
 3 20—4 5. 20^h. A strip of cirro-stratus on NE. horizon ; the ground covered with hoar-frost for two hours
 after this. 23^h. Detached cumuli to N., moving very slowly. 2^h. Detached bits of loose cumuli
 and a few linear cirri to S. 5^h. A few patches of cirro-stratus to S. : hazy on E. horizon.
 4 20—5 5. 20^h. Scud : large cirro-cumuli, &c. above. 23^h. Large cirro-cumuli and cumuli. 2^h. Hazy
 scud. 5^h. Scud and loose cumuli : patches of sky round horizon : in some places to E. the sky is
 quite green : rain to NE. and E.
 5 20—6 5. 20^h. A thin film of fine linear cirri over the whole sky : thick cirro-strati to SE. and E.
 23^h. Nests of cirrus, flamed here and there, cover almost the whole sky, and move slowly from N. :
 detached cumuli below from NW. 2^h. Cirrous-edged cumuli : scud : a thin film of linear cirri
 over the sky : wind in gusts. 5^h. Scud : cirro-cumuli : cirrous haze.
 6 20—7 5. 20^h. Fine cirri, becoming haze ; in some places like great brushes, the hairs lying from WNW. :
 scud below. 23^h. Thin detached patches of scud : sky covered with a thin film of linear cirri ;
 the cirri in some places gathered into nests like loose cirro-cumuli, becoming haze near the horizon.
 2^h. As at 23^h ; the scud in large masses. 5^h. Nearly as at 23^h ; the cirrous nests lying in lines
 from WNW., and apparently moving from about NNW. ; in some places like foam.
 7 20—8 5. 20^h. Scud. 23^h. Large loose cirro-cumuli : quite thick towards the E. : sky at the interstices
 of the cirro-cumuli and to NW. : the clouds seem very high, and the vault has a more expansive
 appearance than usual : the clouds breaking up. 2^h. Detached patches of cumuli : fine linear and
 curled cirri pointing WNW. ; the linear cirrus becomes haze near the horizon ; in some places it
 is mottled, reticulated, and flamed ; the cumuli becomes cumulo-strati on horizon. 5^h. Linear,
 mottled, and curled cirri, gathered into nests in some places, and becoming haze near the horizon.
 9 20—10 5. 20^h. Scud : different kinds of cirrous clouds above. 23^h. Scud and loose cumuli ; the portion
 that is considered sky is nearly covered with a fine film of linear and slightly pectinated cirri,
 pointing N. and S. ; in some places it becomes haze. 2^h. Zigzag linear and mottled cirri : cir-
 rous haze : a few patches of scud. 5^h. Nearly as at 2^h ; the cirri becoming slightly hazy.
 10 20—11 5. 20^h. Scud. 23^h. Linear cirri to N. and S., becoming haze to N., and lying E. and W. : a few
 patches of loose cumuli to N. 2^h. A thin film of cirrous haze to N. : linear cirri to S. : cumuli
 to E. 5^h. 1½ tenths of loose cumuli ; the rest a kind of woolly cirro-cumuli : cirro-strati on
 horizon.
 11 20—12 5. 20^h. Linear cirri, all to E. ; some of the cirri like waves : it has been frost during the night,
 and there is still a little hoar-frost. 23^h. Cumuli to N. : different kinds of cirri over the sky.
 2^h. Cirri of different kinds, principally linear and waved, like one side of a feather, the middle
 pointing WNW., and the fibres pointing SSW. 5^h. Chiefly woolly cirri, like large feathers,
 with the curl upwards : cirro-strati on N. horizon.

OCTOBER.

- d h d h
 12 20—13 5. 20^h. Linear cirri to NE. : a thick bank to E. : mist rising from the ground : the ground covered with hoar-frost. 23^h. Various kinds of cirrus. 2^h. Very fine linear cirri and other varieties. 5^h. Cirri of almost every kind, but chiefly linear ; very thick to N.
- 13 20—14 5. 20^h. Scud, dropping the slightest possible rain : sky on NE. horizon. 23^h. Scud or loose cumuli : linear cirri above. 2^h. Loose-edged cumuli and cumulo-strati : woolly and linear cirri above. 5^h. Cirro-cumulous scud, becoming cirro-strati to E. : cirrous haze and linear cirri cover about three-tenths of the sky : large loose-edged cumuli rising in W.
- 14 20—15 5. 20^h. Cirro-cumulous scud assuming the form of cirro-strati to S. and E. 23^h. Detached patches of loose cumuli, the greater part on S. horizon. 2^h. Two currents of loose-edged cumuli and cumulo-strati. 5^h. Loose cumuli to S., like large cirro-cumuli, which near the zenith become small.
- 16 20—17 5. 20^h—23^h. Nearly homogeneous. 2^h. A little more broken : scud : cumuli to N. 5^h. A loose sort of cirro-cumuli highest, and in N. half of the sky : in the S. is a great mass of scud : rain to SE.
- 17 20—18 5. 20^h. From NNE. round by S. to SSW. is a mass of thick woolly feathery cirrus, radiating from SSE., reaching to NE., where there are cirro-strati ; the feathers appear to move round their centres ; on the horizon are watery-looking cumuli, then the thick cirrus, which becomes gradually thinner to near the zenith. 23^h. Detached loose cumuli : cirrous haze to SE. and NNW. ; the linear cirri still radiating from SSE. 2^h. Loose detached cumuli : cirrous haze on SSE. and N. horizon : wind varying. 5^h. Rain for half-an-hour : very dark, especially to W. : a sort of hazy cloud : wind in gusts, sometimes to 3 or 4.
- 18 20—19 5. 20^h. Clouds clearing off rapidly ; a few minutes ago the quantity was eighth-tenths : thin scud : a kind of cirro-cumuli higher : cumuli to N. 23^h—2^h. Loose detached cumuli. 5^h. Loose cumuli round horizon.
- 19 10—20 10. 10^h. Linear and woolly cirri : cumuli on horizon. 11^h—12^h. Cumuli on horizon. 13^h—14^h. Clear. 15^h—16^h. Lunar corona having the colours of the spectrum ; outer radius about 5° : a few cumuli on NE. horizon. 17^h. As before, but no clouds. 18^h. A few clouds on E. horizon : slight corona : very clear. 19^h. Clear. 20^h—21^h. Heavy cumuli on E. horizon. 22^h. Beautiful cumuli on E. horizon : cirro-cumuli in zenith. 23^h. Loose cumuli and cirro-cumuli : beautifully pinnacled cumuli on E. horizon, which have been stationary since the earliest twilight. 0^h. Cumuli scattered in small portions all round the horizon. 1^h. Cumuli and cumulo-strati round horizon. 2^h—6^h. Cumuli and cumulo-strati, principally on horizon. 7^h—10^h. Cumuli on E. horizon.
- 20 20—21 5. 20^h—23^h. Cumulo-stratus on E. horizon, as there was all the previous day : linear cirri. 2^h. Cumuli on horizon : loose cumuli. 5^h. Loose cumuli or scud : woolly cirri above : cumuli on E. horizon.
- 21 20—22 5. 20^h. Rather heavy rain. 23^h. Loose cirro-cumuli and a few patches of scud. 2^h. Woolly cirri, becoming a kind of cirro-cumuli ; linear cirri and cirrous haze in some places : loose cumuli. 5^h. Scud, very low and moving quickly : hazy clouds : sky stormy-like : a cloud like black cirrus is spread over much of the sky, it moves very little.
- 23 20—24 5. 20^h. Scud : haze above ? 23^h. Loose cumuli and a sort of cirrous cloud becoming cirro-cumuli on the edges, all to E. 2^h. Loose cumuli lying round the horizon. 5^h. Cumuli on horizon, a few linear cirri to W.
- 24 20—25 5. 20^h. Cumuli on N. and E. horizon : linear cirri to S. 23^h. Strange appearance, as if the clouds reached the ground, like a ragged curtain spotted unequally with black : patch of green sky to E. : snow to S. ? 2^h. Nearly as at 23^h, but the tint more uniformly gray : snow on Cheviot : snowing at 3^h. 5^h. As before, but patches of detached scud seen in the grayish haze : a few drops of rain : snowing at 4^h.
- 25 20—26 5. 20^h. A sort of loose cumuli arranged like cirro-cumuli : cumuli on horizon : ground covered with a thin coat of snow. 23^h. Snow. 2^h. Sleet till within a few minutes : scud : cirrous haze seen above : wind varying. 5^h. Scud ; some of it very low : the sky covered with a thin cloud.
- 26 20—27 5. 20^h. Loose cirro-cumuli from N. : scud very low from about W., some from N., but all moving very slowly : mixed cirri seen very low, with a dark cloud above the scud : cumulo-strati to S., cirro-cumulous on the edges. 23^h. Highest clouds woolly cirri, linear in some places : loose scud : sky stormy-like. 2^h. Cumulous scud to S. and N. : a kind of cirrous cloud above : like rain to E., occasional drops here : a few patches of sky. 5^h. Scud : cirrous clouds above : light rain : wind varying from SSW. to NNW.
- 27 20—28 5. 20^h. Scud, like small cumuli : a kind of cirrous cloud below a great mass of scud : watery cumuli

OCTOBER.

- to NE., very gray; like a volcano burning in one place: linear cirri to S.: sky rather indescribable: most of the scud cirrous. 23^h. Vertebrated cirri lying N. and S.: cumuli to NW. and SE.: masses of cirrous scud and loose cumuli to W. 2^h. Loose cumuli: fine woven or reticulated cirri, the thickest lines lying N. and S.: cirrous haze to E.: woolly cirri in zenith becoming cirro-cumuli in some places: wind varying. 5^h. Cirro-cumulous scud: a kind of woolly cirri seen above.
- 28 20—29 5. 20^h. Loose cirro-cumuli on horizon from N., round by E. to S. 23^h. Cirro-strati to E.: linear cirri to W., like circles crossing in long arches from NNE. to WSW. 2^h. The sky to W. covered with cirri so close as almost to become haze; the structure is well seen to E., where there are fine hollow lines concave to N., with a foamy kind of line at right angles moving from NNW.; these lines are less distinct and lower than the first, being like bundles of woolly cirri: a few patches of cumuli to E., and cumulo-strati on E. horizon. 5^h. Loose cirro-cumuli, like scud, covering six-tenths of the sky: linear cirri and cirrous haze above: cirro-strati to S.
- 30 20—31 5. 20^h. Large loose cirro-cumuli, which become a sort of sandy-like cirrous cloud round horizon. 23^h. Cirro-cumuli and cirrous haze above: loose cumuli and scud below: the cirro-cumuli largest in zenith: patches of small cirro-cumuli in the haze to S. 2^h. Hazy: cirrous clouds highest, rippled, like sand on the sea-shore: cirro-stratous scud; some of the cirrous clouds are cirro-cumulous; a general grayish-blue appearance. 5^h. Hazy cirri: scud below: the clouds have all sorts of colours, grayish-blue, deep blue, orange, red, white, &c.: vertebrated cirri: a range of cumulus, extending about 50° along E. horizon, like a long pillar lying on its side.
- 31 20—31 23. 20^h. Smoky scud from WSW.: another current of scud higher from N. by W.: beautiful cirri highest from about W.; the cirrus is mottled, woolly, and linear, some of it like swan-down. 23^h. Loose irregular cirro-cumuli: cirro-strati to N. and S.: cumuli of different kinds to E.: cirrous haze to N.

NOVEMBER.

- 1 2—1 5. 2^h. Loose cirro-cumuli: cirrous haze to N.: cirro-strati and loose cumulo-strati to N. and NE. 5^h. Cirrous cirro-cumuli, coloured gray, fringed with red; thick to E. and S., where they assume a stratified form.
- 1 20—2 5. 20^h. Thin ragged scud, apparently touching the ground about three miles distant: cirri seen above. 23^h. Scud; neither so thin nor so low as at 20^h. 2^h. Scud moving very slowly: sky on E. and SE. horizon; occasionally patches in zenith. 5^h. Scud; motion very slow: cirrous clouds are now seen where the sky was at 2^h.
- 2 20—3 5. 20^h. Scud. 23^h. Cumulo-strati and large loose cirro-cumuli, both dropping a little rain; the cumulo-strati lowest. 2^h. Loose cumuli. 5^h. Scud round horizon, principally to E., in long strata descending in showers: cirro-cumulous patches crossing the zenith: the sky quite gray.
- 3 20—4 5. 20^h. Cirro-cumulous scud, with masses of it and heavy gray cumuli round horizon; to the N. they are like a gray curtain; to the S. some of the cumuli have cirrous crowns, forming nimbi; and some of the cumuli tops are now tipped with red. 23^h. Piles of cumulo-strati on horizon; nimbi to SE. and S., crowned with cirrus: small patches of scud: showers occasionally: the extremity of a rainbow seen within 100 yards. 2^h. Beautiful cumulo-strati and cirrous-crowned nimbi, principally near horizon: loose cirro-cumuli in zenith: shower of small hail about an hour ago: showers every half-hour: wind varying. 5^h. Large masses of loose cumuli and nimbi: shower to E. approaching,—here in five minutes.
- 4 20—5 5. 20^h. A sort of loose cirro-cumuli and scud, falling in rain in many places, and here occasionally: a few fine cirro-cumuli seen above. 23^h. Nimbi dropping like pencils: a sort of cirro-cumulous disposition of cloud: showers around: extremities of rainbows seen occasionally: the quantity of clouds often more or less: light shower of the most minute drops. 2^h. Scud and nimbi: smart shower of very fine rain: large cirro-cumuli above: very dark to W. and N. 5^h. Scud, cumuli, and nimbi: sky quite hazy to E.: about 10° above the E. point of the horizon is a large patch of flesh-red: showers.
- 6 20—7 5. 20^h. Cirro-cumulous scud: rain to S. 23^h. Nearly as before; sky on NW. horizon: sunshine occasionally. 2^h. Thicker than at 23^h; no sunshine. 5^h. Loose or ragged cirro-cumuli moving from SSW.; a little ago from SSE.?: sky on S. horizon, where it is white; red to E.: snow on Cheviot.
- 7 20—8 5. 20^h. Cirrous and loose cirro-cumuli: sky very calm: linear cirri: the sky almost covered with

NOVEMBER.

- a cirrous cloud, which it is difficult to distinguish from sky. 23^h. Cirrous clouds: fine cirro-cumuli: thick cirrous haze, having cumulous heads to E.: the sun's rays project a faint shadow on paper. 2^h. Cumulo-strati over two-tenths of sky: cumuli: linear and mottled cirri and cirrous haze: cirrous haze on E. horizon; its formation of linear cirri becoming evident at about 15° altitude. 5^h. Cumulous scud: cumulo-strati and cirro-strati to E., with a bluish-black cirrous haze: beautiful ranges of cumulo-strati about an hour ago: sky hazy.
- 8 20—9 5. 20^h—2^h. Light rain: clouds moving rapidly: wind settling at 2^h: calm at 3^h. 5^h. Cumulous scud: sky to S. hazy: a patch of red to N.: nearly calm, but occasionally gusts.
- 9 20—10 5. 20^h. Linear cirri to SE.: a little hoar-frost on the ground. 23^h. Fine cirro-cumuli and linear cirri; the linear cirri so fine as almost to be haze, occupying about 2½ tenths of sky to S.; the cirro-cumuli lowest and moving slowly: a mass of cirro-cumuli to NW. 2^h. Cirrous haze: scud below. 5^h. Thick cirrous haze.
- 10 20—11 5. 20^h. Light rain: very thick and dark. 23^h—2^h. Scud: breaking up a little, and a slight shower at 2^h. 5^h. Clouds nearly homogeneous: a little foggy.
- 11 20—12 5. 20^h. The clouds have rather a broken appearance, moving very slowly: light mist. 23^h. Clouds broken, and rather cirro-cumulous; motion very slow. 2^h. Scud, like cedar branches: cirro-cumuli seen above with cirrous haze: wind rising. 5^h. Scud: cirro-cumuli above.
- 13 20—14 5. 20^h. Loose cirro-cumuli: cumuli on NE. horizon: cirro-strati to N.: slight cirrous haze: sky red to W. 23^h. Large loose cirro-cumuli: cumulo-strati on E. horizon: snow on the Cheviots. 2^h. A fine range of cumulo-strati on E. horizon: a few small cumuli and linear cirri to S. 5^h. Linear cirri, becoming haze, radiating from W., and apparently covering the whole sky, as the portion considered sky is whitish; the moon has a corona of the breadth of its own diameter round it: cumuli on E. horizon, where the haze is bluish-black.
- 14 20—15 5. 20^h. Scud and loose cumulo-strati; cirro-cumuli above: the scud creeps along the S. horizon: most beautiful and small cirro-cumuli seen at 22^h, lying in strata from E. to W. 23^h. Cirro-cumuli, but not so fine and distinct as before: loose cumuli moving quickly, much lower than the cirro-cumuli: snowing to E. and N.: some of the fine cirro-cumuli like foam zigzagged. 2^h. Cumulo-strati and scud: woolly cirri above, reaching from SE. to WNW., and moving very slowly: cumulo-strati on N. and E. horizon; much of the cirri flamed and linear, some of it mottled: snow twice or thrice since last observation; very mealy, and not coherent. 5^h. Mottled and loose cirrous clouds: scud: below the cirrous clouds are others like scud swept with a broom, radiating from WSW. in large pencils; it looks very strange; these clouds seem as if blown from the WSW., and seem to spread or move from it.
- 15 20—16 5. 20^h. Scud, &c., moving very slowly. 23^h. Scud: cirrous haze or fine linear cirri over two-tenths of the sky: snow on Cheviots, and clouds resting on their tops. 2^h. Almost as before: a few more patches of pure sky: the wind rose at 23^h 30^m: blowing from ENE. 5^h. As before; wind in gusts.
- 16 20—17 5. 20^h. A bloated mass: snow on Cheviots. 23^h. As before: the clouds opening a little, having a sort of cirro-cumulous disposition: small patches of sky: motion of clouds very slow. 2^h. Loose cirro-cumulous cumuli: cirri. 5^h. As at 23^h.
- 17 20—18 5. 20^h. Cirro-cumuli, which lie in ranges from NNW. to SSE., moving from about WNW.: cirro-strati to E.: the sky almost covered with cirrous haze. 23^h. Scud, covering nearly the S. half of the sky; above it fine linear cirri, covering nearly the whole sky, radiating from NW.; some patches of cirro-cumuli still remain, the cirri becoming haze in many places: wind rising. 2^h. Nearly as before; three-tenths of scud, the rest cirrous haze, and a sort of mottled cirri. 5^h. Nearly all scud, although the sky is covered with a slight cirrous haze; Jupiter is seen through an opening in the clouds at an altitude of about 10°.
- 18 20—19 5. 20^h. Thick mist: light sprinkling of snow on the ground: mist falling like the finest light rain. 23^h. A kind of haze or hazy cloud: not the slightest breath of wind. 2^h. Loose cumuli and cumulo-strati: some mottled cirri above: cumuli on horizon: the air remarkably humid: every thing covered with moisture: the atmosphere not very transparent. 5^h. Heavy black cumuli and scud: some cumuli very low: a few patches of sky: the sky has a strange appearance.
- 20 20—21 5. 20^h. Scud: pinnacled cumuli on NE. horizon: a few minutes ago the sky was quite overcast. 23^h. Loose and well-defined cumuli: fine linear cirri becoming haze: rain or snow to SE. 2^h. Cirrous haze or linear cirri, covering the greater part of the sky, lying in strata to S. from ENE. to WSW: fine pinnacled cumulo-strati on horizon from N. to SE.: snow on Cheviots. 5^h. As

NOVEMBER.

- before : a little more scud, and the haze so thick or white as to render it difficult to distinguish it from milky sky.
- d h d h
21 20—22 5. 20^h. The ground covered by a slight fall of snow : still falling lightly. 23^h—2^h. Scud low : cirrous haze above : still a few flakes of snow : a break in the clouds to S. 5^h. Clouds a homogeneous mass : no scud visible : still a few flakes of snow, which are now increasing.
- 22 20—23 5. 20^h. Scud : cirrous clouds above : sky to S. 23^h. Cirro-strati on E. and S. horizon : frizzled cirri above to N. and E. : clouds resting on Cheviots ; the hills look distant. 2^h. Cirrous-edged cumulo-strati, reaching from W. to SE., and moving along S. horizon : cirrous clouds above : clouds and snow on Cheviots. 5^h. Scud : cirro-strati to NE.
- 23 20—24 5. 20^h—2^h. Scud : cirrous haze : light rain. 5^h. Scud.
- 24 20—25 5. Scud. 20^h. Clouds opening : cirrous clouds above. 23^h. Cirro-strati and cumulo-strati on S. and E. horizon : sky to S. and E. 2^h. Haze : sky to N.
- 25 10—26 10. 10^h—19^h. Scud : slight shower at 14^h. 20^h. Scud : hazy above : fiery red to E. : patches of sky : rain lately. 21^h. Scud : cirrous clouds above : cumuli on E. horizon : hazy patches of sky : red to E. 22^h—3^h. Scud, and haze above. 4^h. Cirro-cumulous scud moving very slowly : sky to S. 5^h—6^h. Scud : dense : most open to SE. 7^h—8^h. Scud : rain at 8^h. 9^h—10^h. Very dark : at 10^h clouds lying in strata from S.
- 27 20—28 5. 20^h. Scud : light rain. 23^h. Scud : cirrous clouds above : patches of sky to E. : light rain. 2^h. As before ; no sky. 5^h. Scud : light rain.
- 28 20—29 5. 20^h. Scud and loose cumulo-strati. 23^h. As before ; sky principally to E. 2^h. Heavy cumuli and scud : cirrous clouds above : rain falling around. 5^h. Scud moving quickly : sky hazy.
- 29 20 Cumulo-strati, scud, and nimbi.

DECEMBER.

- 3 5 Scud.
- 4 20—5 5. 20^h. Scud : clouds breaking. 23^h. Beautifully mottled cirri, radiating from SW. and NE. ; in some places like the finest cirro-cumuli, but chiefly like woolly net-work : scud below. 2^h. Scud : patch of sky on NE. horizon. 5^h. Scud : slightly cirro-cumulous : patches of sky.
- 5 20—6 5. 20^h. Foggy : rain lately : the vane points from NE. 23^h—2^h. Thick mist since 20^h ; cleared off now : not a breath of wind. 5^h. Flocculent cirro-cumuli and scud ; motion scarcely perceptible : mists rising from the ground.
- 6 20—7 5. 20^h. Homogeneous. 23^h. Scud : clouds breaking : small patches of sky. 2^h. Scud and loose cumulo-strati : linear cirri and cirrous haze above. 5^h. Cirro-stratus scud : cirro-cumulous clouds above : clouds red to SW.
- 7 20—8 5. 20^h. Loose cumulo-strati or scud : cirrous clouds over the sky : red to E. 23^h—5^h. Cirro-cumulous scud.
- 8 20—9 5. 20^h. Homogeneous : gray. 23^h. Scotch mist. 2^h. Mist still : scud : clouds breaking : a patch of sky : fine cirri seen above. 5^h. As at 2^h ; no sky.
- 9 20—10 5. 20^h. Thick mist. 23^h. Thick mist : scud : patches of sky : cirrous clouds seen above : in a few minutes the quantity of clouds 8. 2^h. Mist and light rain. 5^h. Cirro-cumulous scud : an hour ago the quantity of clouds was 8.
- 11 20—12 5. 20^h. Dark : light rain : sky to SSE. 23^h. Scud, with lightest rain : patches of hazy sky to SSE., with very gray clouds. 2^h—5^h. Scud : light rain.
- 12 20—13 5. Scud. 20^h. Light rain. 2^h. Rain heavier. 5^h. Light rain.
- 13 20—14 5. 20^h. Scud : patches of sky covered with cirrous clouds to SE. 23^h. A sort of cirrous scud, rather cirro-cumulous in its disposition. 2^h. Sky covered with masses of cirrous clouds, some of them very low ; large white mass to N., moving very slowly : the sky greenish-blue to SE. 5^h. Thick cirrous clouds, lighter here and there.
- 14 20—15 5. 20^h. A few drops of rain : a patch of bright red to SE. 23^h. Scud : light rain. 2^h. Scud. 5^h. A great reservoir of curled scud, boiling up in the SW., and moving quickly across the sky : a few cirrous clouds higher, moving very slowly : sky hazy.
- 15 20—16 5. 20^h. Cirrous clouds : it is difficult to tell what is sky and what is not, on account of the cirrous haze : cumulo-strati and cirro-strati on horizon. 23^h. Scud : misty drizzle. 2^h. Scud : cirrous clouds above : cumuli to E. 5^h. Scud : a few patches of sky to E. and S. : occasionally drops of rain as there have been all day.

DECEMBER.

- d h d h
 16 20—17 5. 20^h. A great mass of scud covered eighth-tenths of the sky at 19^h 50^m, when there was a pretty heavy shower; it moved off so rapidly that there was only one-tenth of clouds at 20^h 0^m: a complete and distinct lunar rainbow seen at 19^h 50^m: cumuli and nimbi to S. and SE. 23. Scud or loose cumulo-strati. 2^h. Cirrous scud, chiefly to W. 5^h. Loose cumuli.
- 18 20—19 5. 20^h. Cirrous clouds and haze. 23^h. Scud: fine mottled, pure, and linear cirri above, pointing N. 2^h. Loose cumuli: fine cumuli on the Cheviots, but the sky covered chiefly with fine cirri, radiating from NNW. and from S. by W., principally mottled, but very thick to W. and NW.: linear to E.: hazy to W.: sky to E. 5^h. Sky covered with cirrous clouds.
- 19 20—20 5. 20^h. four-tenths of scud, the rest linear cirri, which covers almost all the sky: corona round the moon, radius three diameters. 23^h. Scud: varieties of cirri above. 2^h. Cirrous scud: linear and pure cirri of the finest kind, like silken hairs, pointing from WSW. to ENE. 5^h. Thick scud: cirrous clouds above.
- 20 20—20 23. 20^h. Fine cirri and cirrous cirro-cumuli, moving slowly. 21^h. Fine cirrous clouds, mottled and in strata: cirro-strati. 22^h. Fine cirro-cumuli: linear, mottled, and woolly cirri, the latter in little bundles lying in strata: woolly cirro-cumuli; some of the cirri extremely fine; much of the upper cirri appears to radiate from NW. 23^h. Cirrous clouds: cirro-cumuli of various sizes: finest linear cirri highest, pointing from WNW.; the cirrous clouds are very thick in some places, and to the E. become like cirro-strati; the lowest cirro-cumuli are rather large and woolly: about 23^h 20^m a few cymoid cirri were seen, and a few most beautiful mottled cirri.
- 21 0—21 23. 0^h. Large woolly cirro-cumuli moving slowly from WNW.: linear cirri lower, seem as if drifted from WNW.; thick towards horizon, cederaceous to SE. 1^h. The clouds present altogether a troubled appearance: the cirrous clouds have become quite thick, and like a semifluid: radiating from SE. and NW., lying in dark and light strips: masses of scud or loose cumuli creeping along S. horizon from about W. 2^h. Cirrous clouds thick and spread unevenly over the sky: scud to S. 3^h. Some smoky scud very low from WSW.; scud or thick cirrous clouds above it from WNW., the cirrous clouds not so thick as at 2^h: some patches of sky: observed a patch of loose scud moving up from SW., which seemed to develop itself as if under the influence of two currents; when about 30° high, it showed the prismatic colours, something like diffraction spectra from irregularly striated bodies; the clouds have a gray tinge; other cirrous clouds above all. 4^h. The sky has a strange appearance: scud very low, very far below the highest cirri, moving in strings like smoke quickly from SW.: higher scud slower from W.: linear cirri in E., and cirro-cumuli in zenith, &c.; lowest cirro-cumuli gray, and moving slowly from about W., lying in bands from N. to S.; highest very fine, their motion not detected. 5^h. Scud principally: cirrous clouds seen above: sky in zenith. 6^h. Dark, but masses of scud can still be seen moving up from SW. 7^h. Quite dark. 8^h. North part of the sky dark; the south part has dark clouds near horizon, but lightens up to zenith, probably cirrous haze: stars occasionally visible. 9^h. Dark. 10^h. Scud, radiating from SE.: apparently cirrous clouds above. 11^h. Clear in zenith: heavy clouds to E. 12^h. Clear streak in S. horizon: patches of sky to W. and in zenith. 13^h. Light clouds in zenith. 14^h—15^h. Dense clouds to SE. and NW. 16^h. Light clouds on N. and E. horizon; the rest of the sky covered with dark lowering scud. 17^h. Dark clouds, except on N. horizon. 18^h—19^h. Cirrous clouds on horizon. 20^h. Sky covered with heavy clouds, especially on horizon. 21^h. Scud: heavy clouds on SE. horizon. 22^h. Scud: cirrous clouds. 23^h. Scud very low and moving quickly from SW. patches of sky: cirrous clouds seen above.
- 22 0—22 10. 0^h. Scud moving rapidly. 1^h. Scud: cirrous clouds. 2^h. Scud: loose cumuli on E. horizon. 3^h. Heavy rain: clear to N. 4^h. Sky clear, except where cirrous cumuli skirt the horizon on all points but NE. 5^h. Scud: light rain. 6^h—7^h. Scud, &c.: dark. 8^h. Clear in zenith. 9^h. Scud. 10^h. Light rain.
- 22 20—23 5. 20^h. In a few minutes rain, and the sky became nearly overcast: sky on SE. horizon: cirro-strati seen there. 23^h. Scud, in strata to SE.: a few linear cirri: rain freezing on the palings, &c. 2^h. A mass of cumuli to SE., and on NW. horizon. 5^h. Loose-edged cumuli, having a cirro-cumulous disposition, moving quickly.
- 23 20—24 5. 20^h. Scud and cirrous clouds. 23^h—2^h. Clear: a few cumuli on NE. horizon, and on Cheviot. 5^h. Thin cirrous clouds, with a cirro-cumulous disposition.
- 25 20—26 5. 20^h. Sky covered with a thin watery haze, which makes a sort of oblong halo round the moon: light rain. 23^h. Cirrous scud: woolly cirri above: portion of a rainbow seen: rain here lately: raining heavily on Cheviot. 2^h. Homogeneous scud: cirrous clouds above: light rain. 5^h. Cirrous clouds: mottled, linear and woolly cirri, and loose cirro-cumuli: sky nearly covered with fine cirri.

DECEMBER.

- d h d h
 26 20—27 5. 20^h. Clouds lying in a belt from S. to NE. : above NE. horizon, cirro-strati. 23^h. Mixed and linear cirri : cumuli on Cheviot. 2^h. Scud from W by N., and on Cheviot : a few patches of cirri to E. 5^h. Scud and loose cumuli.
- 27 20—28 5. 20^h. Cirrous clouds. 23^h. A few patches of cumuli and scud on Cheviot. 2^h. Sky nearly covered by fine linear cirri : cumuli, &c. on Cheviot. 5^h. Sky covered with cirrous clouds : principally fine linear cirri, which now seem almost haze.
- 28 20—29 5. 20^h—23^h. Scud : light rain : raining heavily to E. at 23^h. 2^h. To the S. a large mass of loose cumulo-stratus : patches of scud : masses of linear cirri. 5^h. Scud and cirrous clouds : thick masses of cirrous clouds to E.
- 29 20—30 5. 20^h—23^h. Scud. 2^h. Scud : linear cirri, &c. above. 5^h. Very thin scud : very black to S. : cirri seen about : wind varying.
- 30 20—31 5. 20^h. Scud. 23^h. Loose cumuli : cumuli on SE. horizon : a few rather large cirro-cumuli : woolly cirrous clouds : portion of a rainbow seen. 2^h. Long strata of woolly cirri, lying from WNW., moving from W by N., covering the greater part of the sky ; a clear space to N. : much linear and reticulated cirri : cirri thickest to S. : cumuli on N. horizon. 5^h. Cirri of different kinds, becoming haze to S. : cumuli on NE. and SW. horizon.

ABSTRACTS OF THE RESULTS
OF THE
MAGNETICAL OBSERVATIONS,
MADE AT THE OBSERVATORY OF
GENERAL SIR T. M. BRISBANE, BART.,
MAKERSTOUN.
1841 AND 1842.

TABLE I.—The Monthly Means of the Declinometer Readings in Westerly Declination, for the Hours 20, 23, 2, and 5.

Month.	20 ^h .	23 ^h .	2 ^h .	5 ^h .	Mean of 20 ^h and 5 ^h .	Range.
1841.	25°	25°	25°	25°.	25°.	
July	25.95	30.65	35.70	33.03	29.49	9.75
August	33.68	37.32	42.55	38.09	35.88	8.87
September	30.26	34.27	39.01	33.87	32.06	8.75
October	30.42	31.99	34.75	30.02	30.22	4.33
November	31.63	32.94	35.15	32.01	31.82	3.52
1842.						
January	27.96	28.47	30.77	29.25	28.60	2.81
February	29.46	31.51	35.74	31.23	30.34	6.28
March	27.51	31.13	35.63	31.92	29.71	8.12
April	30.66	34.84	39.96	35.82	33.24	9.30
May	25.52	30.53	35.98	33.23	29.37	10.46
June	24.94	29.25	34.92	33.31	29.12	9.98
July	25.13	28.65	34.08	31.98	28.55	8.95
August	24.18	29.73	33.53	28.80	26.49	9.35
September	26.53	31.08	34.25	28.85	27.69	7.72
October	25.79	28.42	32.79	28.31	27.05	7.00
November	26.80	28.16	30.38	26.80	26.80	3.58
December	24.85	25.86	27.53	25.36	25.10	2.68

The mean of the Declinations at 20^h and 5^h have been given as an approximate mean for the month. The difference of the Declinations at 20^h and 2^h is given as the approximate diurnal range. The latter must be very near the truth, as 20^h and 2^h are nearly the hours of least and greatest Westerly Declination throughout the year.

It seems very probable, that the Declination in the months of July and August 1841, and of April 1842, are considerably affected by the torsion of the suspension thread. While this would destroy the value of the mean for the month, the diurnal range may be considered as unaffected.

In order to shew the regular changes well, it is advisable to eliminate, as far as possible, those days of irregularity or disturbance in which the positions of the magnet differ considerably from the mean. The following rule was adopted for the determination of the days of irregularity which should be rejected.

If a , b , and c , be the approximate diurnal ranges for three successive months, those days in the middle month are rejected in which the diurnal range exceeds $\frac{a + 2b + c}{2}$.

For the first and last months, the sum $b + c$ or $a + b$ has been used. (See Table XXIII.)

This rule was formed chiefly for the two components of force, for which it is much better suited than for the Declination.

Table II. has been formed after rejecting the days of disturbance thus determined.

TABLE II.—The Monthly Means of the Declinometer Readings, *rejecting disturbances*, in Westerly Declination, for the Hours 20, 23, 2, and 5.

Month.	20 ^h .	23 ^h .	2 ^h .	5 ^h .	Mean of 20 ^h and 5 ^h .	Range.
	25°	25°	25°	25°	25°	
1841.						
July	26.42	30.74	35.14	32.78	29.60	8.72
August	33.68	37.32	42.55	38.09	35.88	8.87
September	30.23	33.34	38.35	34.23	32.23	8.12
October	29.21	31.10	33.90	31.01	30.11	4.69
November	30.55	31.44	33.83	31.60	31.07	3.28
1842.						
January	27.96	28.47	30.77	29.25	28.60	2.81
February	29.25	31.19	34.91	32.48	30.86	5.66
March	27.53	30.98	35.43	31.52	29.52	7.90
April	31.06	34.34	39.73	35.73	33.39	8.67
May	25.50	30.50	35.79	32.57	29.03	10.29
June	24.94	29.25	34.92	33.31	29.12	9.98
July	25.13	28.65	34.08	31.98	28.55	8.95
August	24.18	29.73	33.53	28.80	26.49	9.35
September	26.68	30.99	34.06	28.92	27.80	7.38
October	25.90	28.32	32.75	28.81	27.35	6.85
November	26.58	27.92	30.02	26.98	26.78	3.44
December	24.88	25.94	27.31	25.54	25.21	2.43

Each month shews markedly an increase of Westerly Declination from 20^h till 2^h, and a decrease from 2^h till 5^h.

The means cannot be trusted for indications of an annual period. The diurnal range, however, increases considerably in summer compared with winter, and the ranges of the months in 1841 and 1842 agree very well. The maximum range occurs in May 1842, but it seems probable that the ranges for April, June, and July, 1842, are less than they should be, owing to disturbances, which have not been eliminated by the previous rule.

The two following Tables are formed from Table II.

TABLE III.—The Westerly Declination at the Observation Hours for periods of Three Months, for the Summer and Winter Months, and for the Year 1842.

Period.	20 ^h .	23 ^h .	2 ^h .	5 ^h .	Mean of 20 ^h and 5 ^h .	Range.
	25°	25°	25°	25°	25°	25°
1841.						
July, Aug., Sept.	30.11	33.80	38.68	35.03	32.57	8.57
Oct. and Nov.	29.88	31.27	33.86	31.30	30.59	3.98
1842.						
Jan., Feb., March	28.24	30.21	33.70	31.08	29.66	5.46
April, May, June	27.17	31.36	36.81	33.87	30.52	9.64
July, Aug., Sept.	25.33	29.79	33.89	29.90	27.61	8.56
Oct., Nov., Dec.	25.79	27.39	30.03	27.11	26.45	4.24
Jan., Feb., March } Oct., Nov., Dec. }	27.01	28.80	31.86	29.09	28.05	4.85
April, May, June } July, Aug., Sep. }	26.25	30.57	35.35	31.88	29.06	9.10
The Year.	26.63	29.69	33.61	30.49	28.56	6.98

TABLE IV.—The Yearly Decrease of Westerly Declination, as Deduced from the Four Daily Observations in the Five Months of 1841 and 1842.

Month.	20 ^h .	23 ^h .	2 ^h .	5 ^h .	Mean of the Four Hours.
July	1.29	2.09	1.06	0.80	1.31
August	9.50	7.59	9.02	9.29	8.85
September	3.55	2.35	4.29	5.31	3.87
October	3.31	2.78	1.15	2.20	2.36
November	3.97	3.52	3.81	4.62	3.98
Means	4.32	3.66	3.87	4.44	4.07

If the results for July and August be rejected, the mean of the other three months will be 3.40.

TABLE V.—The Extreme Readings of the Declinometer for each Month from the Four Daily Observations.

Month.	North End of Magnet Farthest				Range.
	E.		W.		
	Göttingen Mean Time.	Declination.	Göttingen Mean Time.	Declination.	
1841.	d. h. m.	° ' "	d. h. m.	° ' "	' "
July	12 20 0	25 21.80	15 2 0	25 41.29	19.49
August	11 20 0	25 26.81	23 20 0	25 50.30	23.49
September	8 20 0	25 22.64	25 2 0	25 53.14	30.50
October	12 20 0	25 21.67	24 20 0	25 45.59	23.92
November	24 20 0	25 25.58	5 2 0	25 49.77	24.19
1842.					
January	27 20 0	25 25.30	29 2 0	25 33.31	8.01
February	17 5 0	25 18.15	18 2 0	25 40.52	22.37
March	9 5 0	25 21.23	30 2 0	25 42.80	21.57
April	24 20 0	25 20.85	14 20 0	25 52.33	31.48
May	18 20 0	25 21.38	16 5 0	25 49.71	28.33
June	2 20 0	25 19.92	10 2 0	25 40.63	20.71
July	20 20 0	25 20.93	2 2 0	25 38.01	17.08
August	16 20 0	25 20.15	4 23 0	25 38.92	18.77
September	25 20 0	25 22.20	22 2 0	25 40.23	18.03
October	17 5 0	25 16.43	8 2 0	25 36.80	20.37
November	11 5 0	25 22.44	10 2 0	25 38.37	15.93
December	8 5 0	25 18.83	30 2 0	25 31.76	12.93

The range of the five months of 1841 from the Daily Observations is 31.5. The Westerly Declination being least in October, 8.4 below the mean of the month; and greatest in September, being 20.9 above the mean of the month.

The range for 1842 is 35.9. The Westerly Declination being least in October, 10.9 below the mean of the month; and greatest in April, being 18.9 above the mean of the month.

TABLE VI.—The Extreme Readings of the Declinometer for each of the Term-Days.

Month.	North End of Magnet Farthest				Range.
	E.		W.		
	Göttingen Mean Time.	Declination.	Göttingen Mean Time.	Declination.	
1841.	d. h. m.	° ' "	d. h. m.	° ' "	' "
July	21 18 0	25 24.95	21 16 0	25 46.83	21.88
August	27 11 10	25 21.18	28 1 35	25 48.25	27.07
September	22 10 25	25 26.17	23 1 25	25 41.67	15.50
October	21 6 40	24 56.85	21 1 20	25 39.25	42.40
November	27 8 50	25 24.43	27 1 15	25 33.30	8.87
December	23 9 10	25 24.82	23 0 10	25 35.53	10.71
1842.					
January	19 10 36	25 23.17	20 4 18	25 38.89	15.72
February	25 10 0	25 22.42	26 2 24	25 37.02	14.60
March	24 8 36	25 9.38	23 13 12	25 40.38	31.00
April	20 15 24	25 22.38	20 16 12	25 46.82	24.44
May	27 21 0	25 25.02	28 2 18	25 36.23	11.21
June	23 8 6	25 16.95	23 1 0	25 37.23	20.28
July	20 10 0	25 16.77	21 1 42	25 32.87	16.10
August	26 12 42	25 17.47	26 11 42	25 33.13	16.66
September	22 7 30	25 11.10	22 1 12	25 41.73	30.63
October	19 10 48	25 16.26	19 13 18	25 38.23	21.97
November	25 10 0	25 26.22	26 1 42	25 31.70	5.48
December	20 10 0	25 22.40	21 0 36	25 30.93	8.53

The range of the six Term days of 1841 is 51.4; the least Westerly Declination occurring in October, being 33.3 below the mean of the month; the greatest in August, being 12.4 above the mean of the month.

The range of the twelve terms in 1842 is 37.4; the least Declination occurring in March, being 20.1 below the mean of the month; the greatest in April, being 13.4 above the mean of the month.

TABLE VII.—The Extreme Readings of the Declinometer during Extra Observations for each Month in which Extra Observations were made.

Month.	North End of Magnet Farthest				Range.
	E.		W.		
	Göttingen Mean Time.	Declination.	Göttingen Mean Time.	Declination.	
1841.	d. h. m. s.	° ' "	d. h. m. s.	° ' "	' "
August	20 22 40 0	25 35.28	20 23 20 0	25 38.30	3.02
September	25 5 35 18	25 21.07	25 6 20 18	27 1.56	100.49
1842.					
May	24 8 0 0	25 30.45	16 5 0 0	25 49.71	19.26
July	1 20 42 0	25 6.55	2 11 48 0	25 50.28	43.73
August	6 5 30 0	25 21.65	19 5 48 0	25 34.88	13.23
September	2 8 24 0	24 54.28	21 2 0 0	25 37.30	43.02
October	17 5 24 0	25 5.08	18 3 4 0	25 32.87	27.79
November	3 8 0 0	25 17.57	21 20 48 0	25 40.98	23.41
December	9 5 54 0	25 9.58	9 8 24 0	25 36.22	26.64

The range of all the disturbances observed in 1842 is 56'.

The least Westerly Declination occurs in September, being 33.5 below the mean of the month; the greatest in July, being 21.7 above the mean of the month.

The range of Declination from all the observations of 1841 is 2° 4'.7. The least Westerly Declination occurring in the October term 1841, being 33.3 below the mean of the month; the greatest during the disturbance September 25. 1841, being 1° 29.3 above the mean of the month.

The range of all the observations in 1842 is 58'. The least Westerly Declination occurring during the disturbance September 2. 1842, being 33.5 below the mean of the month; the greatest in the Daily Observation, April 14^d 20^h 1842, being 18.9 above the mean of the month.

TABLE VIII.—The Monthly Means of the Scale Readings of the Bifilar Magnetometer, as Corrected in this Volume, for 20^h, 23^h, 2^h, and 5^h.

Month.	20 ^h .	23 ^h .	2 ^h .	5 ^h .
1841.	Sc. Div.	Sc. Div.	Sc. Div.	Sc. Div.
July	472.04	466.30	486.96	500.35
August	528.00	528.28	540.45	550.06
September	{ 544.36 562.12 558.26	{ 540.08 554.27 552.32	{ 554.78 575.74 564.55	{ 558.86 593.05 585.93
October	{ 485.32 495.31 489.60	{ 484.42 495.14 489.78	{ 496.05 517.36 506.20	{ 507.19 509.86 508.46
November	502.48	499.33	509.41	510.47
1842.				
January	516.45	513.28	522.98	522.81
February	517.62	514.61	523.82	528.07
March	518.40	513.20	525.92	532.65
April	510.58	507.32	524.48	537.73
May	524.78	520.31	533.78	542.47
June	527.29	523.56	539.14	549.57
July	521.85	521.21	542.29	549.90
August	528.38	524.02	542.77	550.14
September	531.31	523.78	540.32	545.03
October	534.60	527.32	540.12	543.03
November	536.26	533.85	542.97	544.06
December	544.33	542.69	547.79	547.74

As there was an adjustment of the Bifilar Magnetometer between July and August, and between September and October 1841, the observations in July 1841 are not comparable with the others; August and September 1841 are comparable with each other only.

In September 1841 and October 1841, the torsion circle was moved 50', in order to make the middle of the scale nearly the mean reading, from which it had moved considerably in each case after the previous adjustment: there seems little doubt that this rapid change had some connection with torsion in the silver wires. It is very probable that this source of error still shews itself in November 1841.

The observations from September 7^d 20^h till the end of September have been reduced to the value of v in August and beginning of September; those from October 6^d to October 20^d have been reduced to the value of v after. In each case, the means of reduced and unreduced portions of the month have been printed in small type, the means in large type being the means for the month.

A new and preferable value of q , the co-efficient for the temperature correction, having been obtained from a comparison of the Daily Observations in 1844, the following Table has been formed; it was thought well, however, to give the means as corrected in this Volume, for the purposes of comparison.

TABLE IX.—The Monthly Means of the Bifilar Magnetometer Scale Readings, *Corrected by a new value of q,* for the Hours 20, 23, 2, and 5.

Month.	20 ^h .	23 ^h .	2 ^h .	5 ^h .	Mean of the Four Hours.	Approximate Mean Daily Range.
1841.	Sc. Div.	Sc. Div.	Sc. Div.	Sc. Div.	Sc. Div.	Sc. Div.
July	457.45	450.82	470.26	482.54		31.72
August	516.26	515.87	526.92	535.81	523.71	19.94
September	{ 534.79 550.63 547.19 }	{ 530.26 542.24 540.24 }	{ 543.78 562.51 558.76 }	{ 547.35 579.17 572.54 }	554.68	32.30
October	{ 475.01 487.27 480.26 }	{ 474.17 486.08 480.12 }	{ 483.07 506.50 494.22 }	{ 494.02 499.04 496.41 }	487.75	16.29
November	496.56	492.98	500.73	501.21	497.87	8.23
1842.						
January	509.23	505.80	513.00	512.05	510.02	7.20
February	508.33	505.02	512.47	515.60	510.35	10.58
March	509.69	503.78	514.81	520.74	512.25	16.96
April	501.46	497.49	512.46	523.95	508.84	26.46
May	512.82	507.53	519.52	527.10	516.74	19.57
June	512.32	507.81	521.90	531.11	518.28	23.30
July	507.23	505.82	525.56	532.15	517.69	26.33
August	512.29	507.27	524.26	530.58	518.60	23.31
September	517.88	509.94	524.98	528.64	520.36	18.70
October	524.91	517.14	528.01	529.90	524.99	12.76
November	526.42	523.32	530.49	530.86	527.77	7.54
December	532.20	530.22	534.37	533.79	532.64	4.15

The small type in September and October 1841 is explained for Table VII.

The following Tables for the Horizontal force are corrected by the new value of *q*.

The rule given after Table I. for the days of irregularity to be rejected, having been applied, the following Table has been formed.

TABLE X.—The Monthly Means of the Bifilar Magnetometer Scale Readings, as Corrected in Table VIII., and *rejecting days of marked disturbance.*

Month.	20 ^h .	23 ^h .	2 ^h .	5 ^h .	Mean of the Four Hours.	Range from the Four Hours.
1841.	Sc. Div.	Sc. Div.	Sc. Div.	Sc. Div.	Sc. Div.	Sc. Div.
July	457.07	454.23	468.70	480.84		25.20
August	519.50	516.45	528.00	534.76	524.68	22.24
September	547.59	541.44	553.38	559.21	550.40	21.60
October	484.10	481.28	487.95	493.37	486.67	12.19
November	499.64	495.01	499.66	500.92	498.81	5.91
1842.						
January	508.62	505.55	513.36	512.87	510.10	7.81
February	507.67	504.91	511.31	515.16	509.76	10.25
March	509.60	504.36	514.72	520.11	512.20	15.75
April	506.04	501.21	512.66	522.92	510.71	21.71
May	512.79	507.51	520.32	525.96	516.64	18.45
June	512.66	508.50	522.28	530.64	518.52	22.14

TABLE X.—*continued.*

Month.	20 ^h .	23 ^h .	2 ^h .	5 ^h .	Mean of the Four Hours.	Range from the Four Hours.
1842.	Sc. Div.	Sc. Div.	Sc. Div.	Sc. Div.	Sc. Div.	Sc. Div.
July	512.39	507.18	521.85	529.82	517.81	22.64
August	512.91	507.43	523.34	528.91	518.15	21.48
September	518.03	511.58	524.85	527.77	520.56	16.19
October	525.19	519.58	528.01	529.39	525.62	9.51
November	527.27	525.24	530.71	531.40	528.65	6.16
December	532.36	530.15	535.20	534.90	533.15	5.05

In Tables VIII. and IX. the mean of the four observations has been given as an approximate mean for each month; the last column contains the range deduced from these four observations, and is probably not far from the true diurnal range.

In all the months, with the exceptions of January and December 1842, 23^h shews the least force of the four hours; the greatest force is at 5^h. In January and December 1842, the greatest force is at 2^h; in October 1842, and November 1841 and 1842, the force at 2^h differs little from that at 5^h. The minimum seems therefore to occur throughout the year a little before 23^h (or before 10^h A. M. Makerstoun mean time); the maximum about 5^h (or 4^h P. M. Makerstoun time) in summer, and between 2^h and 5^h (or 1^h and 4^h P. M. Makerstoun time) in winter. In December 1842, the maximum occurs about 2^h P. M. Makerstoun time. The diurnal ranges, as given in the last column, though affected by the shifting of the curve in the summer and winter months, shew markedly a great and regular increase from winter to summer, and decrease from summer to winter. Although the rejection of the days of irregularity have considerably softened the asperities in the Means of Table VIII., the depressions in June and July being considerably removed when compared with May, the depression in April still remains.

The force on the whole increases from the beginning of the year till the end; the increase being most rapid after September 1842; and it is nearly constant for the summer months.

The following Table has been deduced from Table X.

TABLE XI.—The Means of the Bifilar Magnetometer Readings *minus* the least mean, in parts of the whole Horizontal Force, for periods of Three Months, for the Summer and Winter Months of 1842, and for the Year 1842.

Period.	20 ^h .	23 ^h .	2 ^h .	5 ^h .	Mean.	Range.
1841.						
July, Aug., Sept.	0.00058	0.00000	0.00177	0.00288		0.00288
Oct., Nov.	0.00046	0.00000	0.00071	0.00112	0.00057	0.00112
1842.						
Jan., Feb., March	0.00256	0.00210	0.00312	0.00349	0.00282	0.00139
April, May, June	0.00279	0.00220	0.00378	0.00480	0.00339	0.00260
July, Aug., Sept.	0.00329	0.00257	0.00440	0.00509	0.00384	0.00251
Oct., Nov., Dec.	0.00502	0.00462	0.00540	0.00547	0.00513	0.00085
Jan., Feb., March, } Oct., Nov., Dec. }	0.00379	0.00336	0.00426	0.00448	0.00397	0.00112
April, May, June, } July, Aug., Sept. }	0.00304	0.00238	0.00409	0.00494	0.00361	0.00256
The Year	0.00341	0.00287	0.00417	0.00471	0.00379	0.00184

The quarter, July, August, and September, is not comparable with the following period.

The Means for 1842 shew a regular increase of force in the first three quarters; in the last the force increases with more rapidity.

TABLE XII.—The least and greatest Readings of the Bifilar Magnetometer for each Month, from the Daily Observations.

Month.	Bifilar Magnetometer.						Range.		
	Lowest.			Highest.					
	Göttingen Mean Time.		Reading.	Göttingen Mean Time.		Reading.			
	d.	h.	m.	Sc. Div.	d.	h.	m.	Sc. Div.	
1841.									
July	19	23	0	426.9	21	5	0	501.1	74.2
August	4	23	0	492.4	26	5	0	554.8	62.4
September	3	23	0	524.5	25	5	0	875.9	351.4
October	6	23	0	447.8	25	2	0	638.6	190.8
November	18	20	0	438.0	18	2	0	515.9	77.9
1842.									
January	21	23	0	496.0	25	2	0	519.6	23.6
February	1	23	0	497.7	24	2	0	530.4	32.7
March	27	23	0	490.2	23	2	0	534.5	44.3
April	14	20	0	446.8	15	5	0	549.9	103.1
May	17	23	0	495.6	16	5	0	555.4	59.8
June	13	23	0	490.8	20	5	0	542.8	52.0
July	3	20	0	429.6	4	2	0	609.8	180.2
August	5	23	0	479.8	19	5	0	574.0	94.2
September	28	23	0	492.3	9	5	0	541.2	48.9
October	16	23	0	507.4	20	5	0	537.5	30.1
November	21	20	0	492.2	28	5	0	540.6	48.4
December	7	5	0	520.4	28	2	0	542.4	22.0

In the five months of 1841, the range of Horizontal Force from the Daily Observations is about 0.05708.

The force being below the mean of the month 0.00760 in November, and above the mean of the month 0.04948 in September.

In 1842, the range, in parts of the whole Horizontal force, is 0.02252. The force being below the mean of the month 0.01102 in July, and above the mean of the month 0.01150 in July.

TABLE XIII.—The least and greatest Readings of the Bifilar Magnetometer on each Term-Day.

Month.	Bifilar Magnetometer.						Range.		
	Lowest.			Highest.					
	Göttingen Mean Time.		Reading.	Göttingen Mean Time.		Reading.			
	d.	h.	m.	Sc. Div.	d.	h.	m.	Sc. Div.	
1841.									
July	21	15	52½	423.6	22	7	22½	485.3	61.7
August	27	22	52½	509.2	28	6	42½	556.6	47.4
September	22	23	2½	543.0	23	6	12½	576.6	33.6
October	20	14	32½	441.0	20	11	52½	525.8	84.8
November	27	8	42½	496.5	27	9	32½	505.5	9.0
December	22	10	32½	492.1	23	9	12½	514.4	22.3

ABSTRACTS FOR THE HORIZONTAL FORCE.

TABLE XIII.—*continued.*

Month.	Bifilar Magnetometer.				Range.
	Lowest.		Highest.		
	Göttingen Mean Time	Reading.	Göttingen Mean Time.	Reading.	
1842.	d. h. m.	Sc. Div.	d. h. m.	Sc. Div.	Sc. Div.
January	19 22 2	498.8	19 12 38	515.4	16.6
February	26 0 8	501.1	26 4 56	517.4	16.3
March	23 13 2	463.7	24 8 38	558.3	94.6
April	20 16 2	455.0	21 5 26	538.6	83.6
May	27 23 20	508.5	28 6 8	536.3	27.8
June	22 21 20	497.7	23 8 8	553.1	55.4
July	20 23 8	507.9	21 3 38	533.5	25.6
August	26 22 56	507.0	27 6 38	539.4	32.4
September	21 22 26	503.6	22 7 32	564.3	60.7
October	19 22 50	514.7	19 11 2	562.8	48.1
November	25 22 14	522.4	25 15 44	537.7	15.3
December	20 20 56	529.1	21 5 44	537.3	8.2

The range, in parts of the whole horizontal force of the five terms of 1841, is about 0.01060. The greatest and least occurring in the October term, being 0.0571 below, and 0.00489 above the mean of the month in Table X.

The range of the terms of 1842 is 0.01242. The least being 0.00696 below the mean of the month in April; and the greatest 0.00546 above the mean of the month in September.

TABLE XIV.—The lowest and highest Readings of the Bifilar Magnetometer during Extra Observations for each Month, in which Extra Observations were made.

Month.	Bifilar Magnetometer.				Range.
	Lowest.		Highest.		
	Göttingen Mean Time.	Reading.	Göttingen Mean Time.	Reading.	
1841.	d. h. m. s.	Sc. Div.	d. h. m. s.	Sc. Div.	Sc. Div.
August	20 22 42 30	517.9	20 23 2 30	520.7	2.8
September	25 6 58 55	629.8	25 4 23 55	903.7	273.9
1842.	d. h. m. s.	Sc. Div.	d. h. m. s.	Sc. Div.	Sc. Div.
May	16 6 39 0	528.8	16 5 2 0	555.4	26.6
July	2 11 47 0	273.1	4 2 0 0	621.1	348.0
August	5 23 2 0	479.8	19 5 2 0	574.0	94.2
September	20 19 32 0	498.7	20 7 38 0	567.3	68.6
October	17 20 2 0	519.9	17 5 26 0	545.3	25.4
November	21 20 2 0	492.2	19 6 44 0	537.2	45.0
December	9 8 26 0	496.2	5 20 38 0	545.8	49.6

The range of the observed portion of the disturbance, September 1841, is 0.04163; the lowest being 0.01207 *above*, and the highest 0.05370 *above* the mean of the month.

The range of the observed disturbances of 1842 occurs in July, and is 0.04350. The lowest being 0.03059 *below*, and the highest 0.01291 *above* the mean of the month.

The range of all the observations in 1841 is about 0.06130. The lowest being in the Daily Observation, November 18. = 0.00760 *below* the mean of the month; the highest 0.05370 *above* the mean of the month, occurs in the disturbance September 1841.

The range of all the observations in 1842 occurs in the July disturbance given above.

TABLE XV.—Containing the Monthly Means of the Balance Magnetometer Readings, as Corrected in this Volume, for the Hours 20, 23, 2, and 5.

Month.	20 ^h .	23 ^h .	2 ^h .	5 ^h .	Range from the Four Hours.
1841.	Mic. Div.	Mic. Div.	Mic. Div.	Mic. Div.	Mic. Div.
July	738.3	744.6	765.7	784.8	46.5
August	715.4	715.8	707.1	724.4	17.3
September	659.9	676.2	677.8	704.4	44.5
October	629.7	655.2	681.6	699.9	70.2
November	621.8	641.8	645.2	655.9	34.1
1842.					
January	{ 948.0 938.1	961.8	941.4	949.2	20.4
February	907.4	918.8	907.2	921.8	14.6
March	{ 882.9 880.5	887.7	864.9	878.4	22.8
April	{ 859.9 868.4	886.1	907.5	924.7	64.8
May	858.0	841.6	837.9	845.2	20.1
June	820.0	815.2	801.6	812.4	18.4
July	783.3	772.8	777.2	814.9	42.1
August	774.3	768.4	764.4	793.9	29.5
September	769.6	778.4	781.1	795.9	26.3
October	{ 769.1 755.5	776.7	769.1	775.9	7.6
November	731.4	747.6	747.1	750.9	19.5
December	705.2	710.1	709.4	709.4	4.9

None of the months in 1841 are comparable with those of 1842; and only October and November in 1841 are comparable with each other. Those months for which two values of T (the time of the Balance needle's vibration in a vertical plane) are used, have the means of the readings corrected according to each value of T given separately.

Another value of *g* having been obtained from the Daily Observations in 1843-4, has been applied, and the following Tables formed.

TABLE XVI.—The Monthly Means of the Balance Magnetometer Readings, *Corrected by a new value of q*, for the Hours 20, 23, 2, and 5.

Month.	20 ^h .	23 ^h .	2 ^h .	5 ^h .	Mean of the Four Hours.	Range from the Four Hours for	
						Each Month.	Two Months.
	Mic. Div.	Mic. Div.	Mic. Div.	Mic. Div.	Mic. Div.	Mic. Div.	Mic. Div.
1841.							
July	803.5	813.4	838.5	861.6		58.1	40.3
August	803.7	807.4	804.9	826.3		22.6	39.0
September	723.6	741.7	749.2	779.0		55.4	67.0
October	664.5	691.8	723.9	743.2	705.8	78.7	61.3
November	644.0	664.6	675.1	687.9	667.9	43.9	
1842.							
January	983.9	1000.0	992.0	1000.5	994.1	16.6	23.8
February	964.0	977.1	974.4	995.1	977.6	31.1	25.5
March	926.3	937.1	928.3	946.3	934.5	20.0	35.5
April	904.9	919.8	930.6	955.9	927.8	51.0	32.7
May	918.2	904.6	906.7	919.1	912.1	14.5	15.4
June	895.0	892.9	885.3	901.6	893.7	16.3	34.2
July	856.6	848.8	858.7	901.0	866.3	52.2	44.4
August	856.0	852.2	855.5	888.9	863.1	36.7	37.7
September	837.3	847.4	856.4	876.1	854.3	38.8	35.0
October	816.7	831.5	833.8	847.9	832.5	31.2	35.0
November	794.7	814.8	825.5	833.5	817.1	38.8	26.6
December	782.4	788.9	793.0	796.9	790.3	14.5	

The means for 1841 are not comparable with those for 1842; and of the months in 1841, only October and November are comparable with each other.

In the five months of 1841, the lowest reading is shewn at 20^h, the highest at 5^h; in August 1841, there is a maximum at 23^h, and a minimum at 2^h. The force increases in the remaining four months from 20^h till 5^h. In July, a minimum seems to occur *after* 20^h; and in September, the force increases but slightly from 23^h till 2^h.

In 1842, the highest reading is at 5^h. In January, February, and March, a maximum occurs about 23^h, and a minimum about 2^h; the lowest readings in these three months is at 20^h.

In April, and the last four months of the year, the readings increase from 20^h till 5^h.

In May a minimum occurs about 0^h, in June about 0^h, in July and August about 23^h. The minimum thus seems to shift from January till June, and from June till December, occurring probably before 20^h in the winter, and about 1^h in midsummer.

The means of the four hours shew a continued diminution of the vertical force, which is irregular from month to month.

The ranges for each month, and for each two months, are irregular; they shew, on the whole, an increase of range in the summer compared with the winter months.

The following Table has been formed from the above.

TABLE XVII.—The Means of the Balance Magnetometer Readings, for periods of Three Months, for the Summer and Winter Months, and for the year 1842.

Periods.	20 ^h .	23 ^h .	2 ^h .	5 ^h .	Mean.	Range.
1841.	Mic. Div.	Mic. Div.	Mic. Div.	Mic. Div.	Mic. Div.	Mic. Div.
July, Aug., Sept.	776.9	787.5	797.5	822.3		45.4
October, November	654.2	678.2	699.5	715.5		61.3
1842.						
Jan., Feb., March	958.1	971.7	964.9	980.6	968.8	22.5
April, May, June	906.0	905.8	907.5	925.5	911.2	19.7
July, Aug., Sept.	850.0	849.5	856.9	888.7	861.3	39.2
Oct., Nov., Dec.	797.9	811.7	817.4	826.1	813.3	28.2
Jan., Feb., March, } Oct., Nov., Dec. }	878.0	891.7	891.1	903.3	891.0	25.3
April, May, June, } July, Aug., Sept. }	878.0	877.6	882.2	907.1	886.2	29.1
The Year.	878.0	884.7	886.7	905.2	888.6	27.2

In the periods of 1841, the force increases from 20^h till 5^h.

The first quarter of 1842 shews a minimum to occur about 20^h, and before 2^h; in the second quarter, the minimum seems about 23^h; the third, between 20^h and 23^h; and in the last quarter, about 20^h. The highest mean is always at 5^h. The means for the winter months exhibit a minimum about 2^h; the means for the summer months have a minimum between 20^h and 23^h.

The means for the year exhibit an increase of force from 20^h till 5^h, the increase from 23^h till 2^h being very small.

The mean of the four observations for each quarterly period shews a very regular diminution of vertical force. The ranges are still irregular.

The following Table has been formed by rejecting disturbances, according to the rule given after Table I.

TABLE XVIII.—The Monthly Mean Readings of the Balance Magnetometer, for the Hours 20, 23, 2, and 5, as Corrected in Table XVII., and rejecting disturbances.

Month.	20 ^h .	23 ^h .	2 ^h .	5 ^h .	Mean of the Four Hours for each Month.	Range of the Four Hours	
						For each Month.	For each two Months.
1841.	Mic. Div.	Mic. Div.	Mic. Div.	Mic. Div.	Mic. Div.	Mic. Div.	Mic. Div.
July	818.8	817.1	836.1	860.6		43.5	31.0
August	808.7	809.5	799.1	817.6		18.5	26.2
September	731.4	745.4	737.2	765.4		34.0	28.9
October	683.1	691.9	690.9	706.9	693.2	23.8	22.2
November	654.4	657.3	665.5	675.1	663.1	20.7	16. ?

TABLE XVIII.—*continued.*

Month.	20 ^h .	23 ^h .	2 ^h .	5 ^h .	Mean of the Four Hours of each Month.	Range of the Four Hours	
						For each Month.	For each Two Months.
1842.	Mic. Div.	Mic. Div.	Mic. Div.	Mic. Div.	Mic. Div.	Mic. Div.	Mic. Div. 11. ?
January	987.2	995.3	992.4	998.3	993.3	11.1	9.6
February	973.1	981.2	977.6	979.9	977.9	8.1	11.5
March	928.2	937.7	928.1	943.0	934.2	14.9	18.2
April	924.2	920.9	915.4	936.9	924.3	21.5	32.9
May	918.1	904.0	899.6	944.0	916.4	44.4	29.4
June	895.9	893.0	886.1	900.6	893.9	14.5	32.9
July	884.9	849.2	841.2	892.5	866.9	51.3	32.6
August	860.9	854.0	847.0	860.0	855.5	13.9	21.4
September	839.8	847.9	855.9	868.8	853.1	29.0	27.3
October	817.4	827.3	825.2	843.1	828.2	25.7	24.7
November	801.9	814.4	821.5	826.1	816.0	24.2	18.4
December	782.4	788.7	793.0	795.1	789.8	12.7	

The rejection of disturbances produces a considerable difference in the results deduced from Tables XVI. and XVII.

In 1841, the highest means occur at 5^h; the lowest mean in July is at 23^h, in August at 2^h, and in September, October, and November, at 20^h.

A maximum occurs in August, September, and October, about 23^h.

A minimum occurs in July, between 20^h and 23^h, in August, September, and October, about 2^h.

In 1842, the highest means, with two exceptions, are at 5^h; in February, the highest is at 23^h, and in August, at 20^h; but they differ little from the mean at 5^h.

The lowest means in the first three and last four months of the year are at 20^h. In the remaining months at 2^h. In March, the means at 20^h and 2^h are equal.

A maximum occurs in January, February, and March, about 23^h, in October about 22^h.

A minimum occurs in January about 2^h, in February between 2^h and 5^h, in March, April, May, June, July, August, and October, between 23^h and 2^h.

The mean of the four hours for each month shews a decrease of vertical force from the beginning to the end of the year; the diminution from month to month is rather irregular.

The ranges for each month are irregular; but when the mean of each two months is taken, the increase of range from summer to winter is very regular, and well marked.

The following Table is formed from Table XVIII.

TABLE XIX.—The Means of the Balance Magnetometer Readings *minus* the least Mean, in parts of the whole Vertical Force, for periods of Three Months, in 1841 and 1842, for the Summer and Winter Months, and Year of 1842.

Periods.	20 ^h .	23 ^h .	2 ^h .	5 ^h .	Mean.	Range.
1841.						
July, Aug., Sept.	0.00000	0.00006	0.00006	0.00037		0.00037
Oct. and Nov.	0.00000	0.00008	0.00012	0.00029		0.00029
1842.						
Jan., Feb., March	0.00211	0.00222	0.00215	0.00225	0.00218	0.00014
April, May, June	0.00146	0.00137	0.00130	0.00165	0.00141	0.00035
July, Aug., Sept.	0.00080	0.00065	0.00062	0.00095	0.00075	0.00033
Oct., Nov., Dec.	0.00000	0.00012	0.00016	0.00027	0.00014	0.00027
Jan., Feb., March, } Oct., Nov., Dec. }	0.00105	0.00117	0.00115	0.00126	0.00116	0.00021
April, May, June, } July, Aug., Sept. }	0.00113	0.00101	0.00096	0.00130	0.00109	0.00034
The Year	0.00109	0.00109	0.00106	0.00128	0.00113	0.00022

The means for July, August, and September 1841, indicate a maximum before 23^h, and a minimum before 2^h; the means of October and November 1841 still indicate a maximum before 23^h, and a minimum before 2^h, but it is much less evident.

In the first quarter of 1842, a maximum at 23^h, and a minimum at 2^h, are well indicated; in the second and third quarters, only the minimum before 2^h is evident, but a maximum in both cases probably occurs between 20^h and 23^h.

The last quarter of 1842 has the same character as that for 1841.

The means for the winter months shew a maximum before 23^h, and a minimum nearer 2^h than 23^h. The means for the summer months shew the minimum about the same time as in the winter months, but the maximum earlier. The means for the year 1842 shew a maximum between 20^h and 2^h, and a minimum about 1^h.

In forming the above Table *k* was taken = 0.000013.

TABLE XX.—The greatest and least Readings of the Balance Magnetometer for each Month from the Daily Observations.

Month.	Balance Magnetometer.				Range.
	Lowest.		Highest.		
	Göttingen Mean Time.	Reading.	Göttingen Mean Time.	Reading.	
1841.	d. h.	Mic. Div.	d. h.	Mic. Div.	Mic. Div.
July	19 20	733.2	17 5	916.7	183.5
August	26 20	707.0	6 5	907.0	200.0
September	24 20	639.0	25 2	990.2	351.2
October	20 20	549.9	25 2	1181.1	631.2
November	3 20	526.6	20 2	769.5	242.9

ABSTRACTS FOR THE VERTICAL FORCE.

TABLE XX.—*continued.*

Month.	Balance Magnetometer.				Range.
	Lowest.		Highest.		
	Göttingen Mean Time.	Reading.	Göttingen Mean Time.	Reading.	
1842.	d. h.	Mic. Div.	d. h.	Mic. Div.	Mic. Div.
January	31 20	955.8	18 5	1038.2	82.4
February	11 20	852.3	17 5	1138.6	286.3
March	23 5	879.7	28 5	1003.2	123.5
April	14 20	609.3	15 5	1097.4	488.1
May	28 2	873.1	16 5	1087.4	214.3
June	10 2	845.1	24 2	930.6	85.5
July	1 20	693.7	4 2	1140.8	447.1
August	5 20	786.8	19 5	1228.5	411.7
September	28 20	810.5	2 5	940.5	130.0
October	13 2	811.8	19 2	929.0	117.2
November	21 20	701.0	22 5	906.1	205.1
December	21 23	769.4	9 5	842.7	73.3

The range of the Daily Observations in 1841, in parts of the whole Vertical Force, is 0.00820; the greatest and least occur in October, and are 0.00634 *above*, and 0.00186 *below*, the mean of the month.

The range of the Daily Observations in 1842 is 0.00894; the greatest force being in August 0.00485 *above* the mean of the month, and the least occurs in April, being 0.00409 *below* the mean of the month.

TABLE XXI.—The greatest and least Readings of the Balance Magnetometer for each of the Term-Days.

Month.	Balance Magnetometer.				Range.
	Lowest.		Highest.		
	Göttingen Mean Time.	Reading.	Göttingen Mean Time.	Reading.	
1841.	d. h. m.	Mic. Div.	d. h. m.	Mic. Div.	Mic. Div.
July	21 16 47½	761.1	21 10 17½	862.9	101.8
August	17 12 57½	541.1	28 6 57½	897.5	356.4
September	22 10 7½	671.7	23 9 57½	743.9	72.2
October	20 19 27½	514.9	21 4 17½	822.7	307.8
November	27 1 57½	646.5	26 11 57½	678.0	31.5
December	22 18 57½	620.3	22 10 27½	716.6	96.3

TABLE XXI.—*continued.*

Month.	Balance Magnetometer.						Range.		
	Lowest.			Highest.					
	Göttingen Mean Time.		Reading.	Göttingen Mean Time.		Reading.			
1842.	d.	h.	m.	Mic. Div.	d.	h.	m.	Mic. Div.	Mic. Div.
January	19	12	40	972.0	20	9	58	1038.1	66.1
February	25	20	10	937.6	26	0	28	973.3	35.7
March	23	12	58	574.9	23	10	4	991.2	416.3
April	20	16	28	783.9	21	5	28	1021.4	210.5
May	27	13	34	844.6	27	18	52	921.1	76.5
June	22	15	28	787.1	23	7	52	953.7	166.6
July	20	13	16	825.2	21	7	52	896.6	71.4
August	26	13	52	761.9	26	10	4	854.8	89.9
September	21	13	46	716.5	22	4	58	871.2	154.7
October	19	13	46	772.8	19	20	52	856.3	83.5
November	25	16	52	785.6	26	2	16	821.5	38.9
December	20	22	28	760.6	21	3	52	807.0	46.4

The range of the Term-Day Observations in 1841 is about 0.00516, in parts of the whole Vertical Force.

The greatest force occurs in October, being 0.00168 *above* the mean of the month; the least occurs in August, being 0.00348 *below* the mean of the month.

In 1842, the range is about 0.00644, in parts of the whole Vertical Force.

The greatest force occurs in April, being 0.00130 *above* the mean of the month; and the least in March, being 0.00514 *below* the mean of the month.

TABLE XXII.—The greatest and least Readings of the Balance Magnetometer during Extra Observations for each Month in which Extra Observations were made.

Month.	Balance Magnetometer.						Range.				
	Lowest.			Highest.							
	Göttingen Mean Time.				Reading.	Göttingen Mean Time.				Reading.	
1841.	d.	h.	m.	s.	Mic. Div.	d.	h.	m.	s.	Mic. Div.	Mic. Div.
August	20	22	57	30	789	20	22	47	30	793	4
September	25	6	1	30	699	25	4	6	30	1150	451
1842.											
May	25	3	26	0	890	16	5	23	0	1166	276
July	2	11	48	0	160	2	0	53	0	1200	1040
August	16	20	36	0	781	19	4	58	0	1229	448
September	20	19	58	0	814	2	3	34	0	995	181
October	17	4	58	0	821	17	5	40	0	871	50
November	21	19	56	0	691	3	7	56	0	955	264
December	5	20	52	0	744	9	7	4	0	964	220

The range of the observed portion of the disturbance September 1841, is 0.00685; the greatest force being 0.00526 *above*, and the least 0.00060 *below*, the mean of the month.

The range of the disturbances of 1842 is 0.01405.

The least force occurs in July, being 0.00919 *below* the mean of the month; the greatest occurs in August, being 0.00486 *above* the mean of the month.

The range of all the observations in 1841 is about 0.00982; the lowest occurring in the August term, being 0.00348 *below* the mean of the month, and the highest on October 25, being 0.00634 *above* the mean of the month.

The range of all the observations in 1842 is that of the disturbances given above.

TABLE XXIII.—Containing the Days of Disturbance and the Ranges of the Three Magnetometers from the Observations at 20^h, 23^h, 2^h and 5^h.

Göttingen Mean Time.	Range.			Göttingen Mean Time.	Range.		
	Declino- meter.	Biflar Magneto- meter.	Balance Magneto- meter.		Declino- meter.	Biflar Magneto- meter.	Balance Magneto- meter.
1841. d. h. d. h.		Sc. Div.	Mic. Div.	1842. d. h. d. h.		Sc. Div.	Mic. Div.
July 14 20—15 5	19.11	35.1	84.7	Jan. 17 20—18 5	1.31	17.4	70.6
19 20—20 5	2.88	52.3	147.8	Feb. 0 20— 1 5	3.91	16.0	82.7
20 20—21 5	13.17	57.1	69.1	6 20— 7 5	11.08	17.8	47.9
Aug. 5 20— 6 5	6.95	55.7	119.0	11 20—12 5	8.05	19.1	140.1
6 20— 7 5	9.08	17.4	76.3	16 20—17 5	22.15	15.4	181.3
23 20—21 5	13.40	42.8	50.3	17 20—18 5	19.19	21.9	127.5
26 20—27 5	13.07	21.5	140.4	23 20—24 5	21.5	103.0
Sept. 0 20— 1 5	9.00	52.4	27 20—28 5	6.19	9.6	61.0
12 20—13 5	16.88	29.1	158.1	March 18 20—19 5	13.78	21.2	52.6
21 20—25 5	22.69	359.2	351.2	27 20—28 5	7.35	43.8	104.5
26 20—27 5	9.88	49.1	235.5	29 20—30 5	11.67	23.7	56.0
28 20—29 5	3.62	29.1	190.9	April 10 20—11 5	9.88	40.4	191.9
Oct. 7 20— 8 5	15.55	42.7	116.7	11 20—12 5	14.12	19.9	93.1
8 20— 9 5	4.23	33.1	60.3	12 20—13 5	17.85	67.4	181.2
11 20—12 5	5.96	43.3	19.7	14 20—15 5	15.41	103.2	488.0
20 20—21 5	6.50	21.1	249.7	15 20—16 5	9.88	29.5	79.1
24 20—25 5	18.45	155.7	605.3	18 20—19 5	9.98	26.1	80.7
25 20—26 5	18.31	16.4	300.3	20 20—21 5	7.13	16.1	81.8
27 20—28 5	8.29	16.0	154.5	24 20—25 5	16.78	25.1	11.1
Nov. 3 20— 4 5	18.86	34.9	242.5	May 15 20—16 5	23.66	55.0	186.7
4 20— 5 5	15.71	16.0	120.5	16 20—17 5	11.18	20.6	80.0
9 20—10 5	7.00	4.3	27.2	18 20—19 5	11.29	14.6	65.0
17 20—18 5	3.93	23.4	11.5	June 3 20— 4 5	15.62	22.4	47.3
18 20—19 5	14.45	62.9	148.0	9 20—10 5	14.68	26.8	74.9
19 20—20 5	7.40	37.2	149.1	12 20—13 5	11.46	25.5	71.0
22 20—23 5	4.97	12.1	35.0	13 20—14 5	8.40	51.6	87.6

TABLE XXIII.—*continued.*

Göttingen Mean Time.			Range.			Göttingen Mean Time.			Range.				
			Declino- meter.	Bifilar Magneto- meter.	Balance Magneto- meter.				Declino- meter.	Bifilar Magneto- meter.	Balance Magneto- meter.		
1842.						1842.							
July	d. h.	d. h.	'	Sc. Div.	Mic. Div.	Oct.	d. h.	d. h.	'	Sc. Div.	Mic. Div.		
	1	20—2	5	11.62	77.5	193.9	12	20—13	5	10.15	0.8	96.5	
	3	20—4	5	9.37	180.0	548.2	13	20—14	5	7.45	8.9	89.5	
	8	20—9	5	5.77	37.0	180.7	16	20—17	5	15.81	28.1	44.6	
	22	20—23	5	7.57	42.1	79.3	18	20—19	5	11.46	13.5	127.1	
Aug.	0	20—1	5	10.48	38.9	98.8	Nov.	1	20—2	5	7.60	5.6	50.7
	5	20—6	5	10.75	33.4	181.7		9	20—10	5	12.35	21.4	115.7
	17	20—18	5	7.85	35.3	106.9		10	20—11	0	10.20	13.9	90.2
	18	20—19	5	7.48	78.0	411.2		20	20—21	5	3.09	16.7	53.7
	23	20—24	5	14.77	11.4	82.8		21	20—22	5	7.79	35.4	205.1
Sept.	1	20—2	5	8.55	18.2	106.2		22	20—23	5	5.26	28.5	60.1
	8	20—9	5	11.21	36.5	69.9	Dec.	5	20—6	5	5.30	11.4	16.4
	12	20—13	5	16.25	38.7	26.9		7	20—8	5	9.44	7.7	24.1
	16	20—17	5	7.13	13.3	96.0		8	20—9	5	2.09	12.4	58.7
	28	20—29	5	12.83	40.5	115.8		29	20—30	5	7.39	14.7	38.1
Oct.	7	20—8	5	10.68	26.9	25.6							

The above Table has been formed thus; if *a*, *b*, and *c*, be the mean range for three successive months, as given in Tables I., IX., and XVI., those days in the month whose range is *b*, have been considered days of disturbance if the range of the four daily observations, for any of the three Magnetometers, exceeds $\frac{a + 2b + c}{2}$. When there is not a month preceding or succeeding, the sum *b* + *c* or *a* + *b* has been used.

In many of the days only one or two of the instruments shew ranges exceeding the test. In the formation of Tables II., X., and XVIII., those days only have been rejected in which the range for the instrument to which the Table belongs has exceeded the test. All the ranges of the two force Magnetometers given above have been corrected by the new values of *q*.

The following Table contains several days in which the irregularity is well marked, but which are not included in the above.

TABLE XXIV.—Days of Marked Irregularity not determined by the Rule used in the formation of Table XXIII.

1841.			1842.			
August	d. d.		November	d. d.	February	d. d.
	15—16			8—9		1—2
September	18—19			9—10	April	0—1
	23—24			10—11	April	25—26
	29—30			11—12	July	4—5
October	6—7			12—13	August	4—5
	12—13			22—23	November	1—2

TABLE XXV.—Monthly Means of Magnetic Dip, from Observations of Needle No. 1.

Month.	Magnetic Dip.									
	Number of Observations.		A. M.	P. M.	Mean of A. M. and P. M.	A. M. minus P. M.	From Three Months.			
	A. M.	P. M.					A. M.	P. M.	Mean.	A. M. minus P. M.
1841.			° /	° /	° /	/	71°	71°	71°	
September	1	2	71 14-19	71 14-18	71 14-18	+ 0-01	15-00	13-79	14-39	+ 1-21
October	4	4	71 18-67	71 14-14	71 16-40	+ 4-53				
November	5	4	71 12-23	71 13-25	71 12-74	- 1-02				
December		1		71 11-31						
1842.										
January	3	2	71 9-94	71 10-66	71 10-30	- 0-72	11-74	11-99	11-86	- 0-25
February	3	4	71 13-53	71 14-04	71 13-88	- 0-51				
March	4	4	71 11-75	71 10-61	71 11-18	+ 1-14				
April	4	5	71 15-58	71 13-43	71 14-50	+ 2-15				
May	4	3	71 12-03	71 12-92	71 12-47	- 0-89	13-35	12-32	12-83	+ 1-03
June	4	4	71 12-45	71 10-47	71 11-46	- 0-02				
July	3	5	71 14-60	71 13-20	71 13-90	+ 1-40				
August	5		71 13-81		71 13-45 ?					
September	4	5	71 12-87	71 12-75	71 12-81	+ 0-12	13-70	12-98	13-34	+ 0-72
October	5	3	71 10-57	71 11-12	71 10-84	- 0-55				
November	3	3	71 9-13	71 6-60	71 7-86	+ 2-53				
December	4	2	71 9-25	71 9-50	71 9-37	- 0-25				

The above Table has been formed by subtracting 12' from the means of the original observations, as a correction for the axle and copper circle. The A.M. observations were made between 20^h and 21^h; the P.M. observations about 6^h.

The diminution of Dip in 12 months has been deduced from four comparisons, as under :—

Sept., Oct., and Nov. 1841, compared with Sept., Oct., and Nov. 1842,	gives $\Delta \theta = -3\cdot59$.
..... Oct., Nov., and Dec. 1842, = -4\cdot59.
Oct. and Nov. 1841, Oct. and Nov. 1842, = -5\cdot22.
..... Nov. and Dec. 1842, = -5\cdot91.
Mean of all =	-4\cdot83.

In all cases, the means of all the observations in the given period has been used, and not the mean of the monthly means for the period.

With the exception of the first quarter of 1842, the quarterly means give the Dip greater in the morning than in the evening; giving the quarterly differences A.M. minus P.M. equal values the mean of the whole is 0'68. The observations of 1842 evince a greater difference in summer than in winter.

TABLE XXVI.—Mean Magnetic Dip for periods of Six Months, and for the Year 1842.

Period.	Magnetic Dip.			
	A. M.	P. M.	Mean.	A. M. minus P. M.
1842.	° /	° /	° /	/
First Six Months	71 12-62	71 12-17	71 12-39	+ 0-45
Last Six Months	71 11-73	71 11-22	71 11-47	+ 0-51
First and Last Quarters	71 10-75	71 10-53	71 10-64	+ 0-22
Second and Third Quarters	71 13-52	71 12-65	71 13-08	+ 0-87
The Year	71 12-16	71 11-74	71 11-95	+ 0-42
Three Months of 1841 and } Twelve Months of 1842 }	71 12-66	71 12-15	71 12-40	+ 0-51

TABLE XXVII.—Monthly Mean Values of $\Delta \theta$, the Differences of Magnetic Dip, for the Observation Hours of 1842, deduced from Tables X. and XVIII. ; the value of $\Delta \theta$ December 2^h being taken as Zero.

Month.	20 ^h .	23 ^h .	2 ^h .	5 ^h .	Mean of the Four Hours.	Range.	Mean of 20 ^h and 5 ^h .	Difference of 20 ^h and 5 ^h .
January	6.11	6.62	5.56	5.71	6.00	1.06	5.91	0.40
February	6.04	6.51	5.63	5.16	5.83	1.35	5.60	0.88
March	5.18	5.99	4.51	4.01	4.92	1.98	4.59	1.17
April	5.59	6.17	4.61	3.56	4.98	2.61	4.57	2.03
May	4.62	5.12	3.39	3.26	4.10	1.86	3.94	1.36
June	4.34	4.84	2.95	2.06	3.55	2.78	3.20	2.28
July	4.22	4.42	2.40	2.05	3.27	2.37	3.13	2.17
August	3.83	4.45	2.28	1.73	3.07	2.72	2.78	2.10
September	2.88	3.83	2.21	1.99	2.73	1.84	2.43	0.89
October	1.64	2.47	1.38	1.44	1.73	1.03	1.54	0.20
November	1.15	1.60	0.97	0.95	1.17	0.65	1.05	0.20
December	0.23	0.60	0.00	0.07	0.22	0.60	0.15	0.16

The Table above was computed from the formula

$$\Delta \theta = \frac{1}{2} \sin 2\theta \left\{ \frac{\Delta Y}{Y} - \frac{\Delta X}{X} \right\}$$

$\frac{\Delta Y}{Y}$ was obtained from Table X., and $\frac{\Delta X}{X}$ from Table XVIII. ; θ being taken at $71^\circ 18'$.

The following Table has been formed from the above.

TABLE XXVIII.—Mean Values of $\Delta \theta$ for Three Months, for the Summer and Winter Months, and for the Year 1842.

Period.	20 ^h .	23 ^h .	2 ^h .	5 ^h .	Mean of the Four Hours.	Range.	Mean of 20 ^h and 5 ^h .	Difference of 20 ^h and 5 ^h .
1842.								
Jan., Feb., March	5.78	6.37	5.23	4.96	5.58	1.41	5.37	0.82
April, May, June	4.85	5.38	3.65	2.96	4.21	2.42	3.90	1.89
July, Aug., Sept.	3.64	4.23	2.30	1.92	3.02	2.31	2.78	1.72
Oct., Nov., Dec.	1.01	1.56	0.78	0.82	1.04	0.78	0.91	0.19
Jan., Feb., March, } Oct., Nov., Dec. }	3.39	3.96	3.00	2.89	3.31	1.07	3.14	0.50
April, May, June, } July, Aug., Sept. }	4.24	4.80	2.97	2.44	3.61	2.36	3.34	1.80
The Year	3.82	4.38	2.99	2.66	3.46	1.72	3.24	1.16

The columns containing the means and differences of 20^h and 5^h have been given for comparison with the Magnetic Dip, obtained from the Inclinometer at these hours.

The winter months indicate a maximum Dip about 23^h, and a minimum between 2^h and 5^h, apparently nearer 5^h than 2^h in the first quarter of 1842, but nearer 2^h than 5^h in the last quarter. The maximum seems to occur somewhat earlier, and the minimum later, in the summer than in the winter months.

The ratio of the difference of Dip at 20^h and 5^h in winter to that in summer is nearly the same from both Tables XXVI. and XXVIII., though the quantities are rather different.

The annual diminution of Dip from Table XXVII. appears greater than that from the observation of the Inclinometer.

TABLE XXIX.—Monthly Mean Values of $\frac{\Delta R}{R}$, the Differences of Total Magnetic Intensity, in parts of the whole force, for the Observation Hours of 1842; deduced from Tables X. and XVIII., the value of $\frac{\Delta R}{R}$ December 20^h being taken as Zero.

Month.	20 ^h .	23 ^h .	2 ^h .	5 ^h .	Mean of the Four Hours.	Range	
						For each Month.	For each Two Months.
January	0.00208	0.00214	0.00220	0.00227	0.00217	0.00019	
February	0.00191	0.00196	0.00200	0.00208	0.00199	0.00017	0.00018
March	0.00140	0.00146	0.00147	0.00172	0.00151	0.00032	0.00024
April	0.00131	0.00121	0.00130	0.00168	0.00137	0.00047	0.00039
May	0.00132	0.00110	0.00121	0.00180	0.00136	0.00070	0.00058
June	0.00107	0.00099	0.00108	0.00136	0.00112	0.00037	0.00053
July	0.00094	0.00046	0.00055	0.00125	0.00080	0.00079	0.00056
August	0.00067	0.00052	0.00064	0.00086	0.00067	0.00034	0.00040
September	0.00049	0.00050	0.00076	0.00095	0.00067	0.00046	0.00040
October	0.00032	0.00035	0.00045	0.00067	0.00045	0.00035	0.00040
November	0.00016	0.00028	0.00044	0.00049	0.00034	0.00033	0.00034
December	0.00000	0.00005	0.00016	0.00019	0.00010	0.00019	0.00026

This Table has been computed from the formula $\frac{\Delta R}{R} = \sin^2 \theta \frac{\Delta Y}{Y} + \cos^2 \theta \frac{\Delta X}{X}$.

TABLE XXX.—Mean Values of $\frac{\Delta R}{R}$ for Three Months, for the Summer and Winter Months, and for the Year 1842.

Period.	20 ^h .	23 ^h .	2 ^h .	5 ^h .	Range.	Mean of the Four Hours.
1842.						
Jan., Feb., March	0.00180	0.00185	0.00189	0.00202	0.00022	0.00189
April, May, June	0.00123	0.00110	0.00120	0.00161	0.00051	0.00128
July, Aug., Sept.	0.00070	0.00049	0.00065	0.00102	0.00053	0.00071
Oct., Nov., Dec.	0.00016	0.00023	0.00035	0.00045	0.00029	0.00030
Jan., Feb., March, } Oct., Nov., Dec. }	0.00098	0.00104	0.00112	0.00123	0.00025	0.00109
April, May, June, } July, Aug., Sept. }	0.00096	0.00080	0.00092	0.00132	0.00052	0.00100
The Year	0.00097	0.00092	0.00102	0.00128	0.00036	0.00105

A maximum of total intensity probably occurs in the winter months before 23^h, and a minimum between 23^h and 2^h.

The maximum seems to occur earlier in the summer months, and the minimum nearer 23^h than 2^h.

The total intensity decreases from quarter to quarter, the rapidity of decrease diminishing rather regularly.

ABSTRACTS OF THE RESULTS
OF THE
METEOROLOGICAL OBSERVATIONS,
MADE AT THE OBSERVATORY OF
GENERAL SIR T. M. BRISBANE, BART.,
MAKERSTOUN.
1841 AND 1842.

ABSTRACTS FOR THE BAROMETER.

TABLE I.—Monthly Means of the Height of the Barometer, corrected for temperature.

Month.	20 ^h .	23 ^h .	2 ^h .	5 ^h .	Mean of the Four Hours.
1841.	in.	in.	in.	in.	in.
July	29.435	29.470	29.482	29.487	29.468
August	29.576	29.566	29.553	29.569	29.566
September	29.479	29.492	29.487	29.468	29.481
October	29.350	29.392	29.363	29.382	29.372
November	29.433	29.493	29.450	29.440	29.454
1842.					
January	29.594	29.611	29.568	29.568	29.585
February	29.592	29.609	29.606	29.641	29.611
March	29.502	29.500	29.483	29.459	29.486
April	29.980	29.978	29.923	29.905	29.946
May	29.656	29.643	29.602	29.601	29.625
June	29.780	29.773	29.765	29.742	29.765
July	29.680	29.676	29.657	29.651	29.666
August	29.718	29.721	29.731	29.717	29.722
September	29.664	29.669	29.635	29.630	29.650
October	29.692	29.695	29.678	29.665	29.682
November	29.440	29.451	29.454	29.450	29.449
December	29.618	29.655	29.655	29.673	29.650

Mean Height of the Barometer for the five months of..... 1841, ^{in.} 29.460.
corresponding..... 1842, ^{in.} 29.634.

A maximum pressure occurs in both years in August, and a minimum in October 1841 and in November 1842.

The greatest mean pressure is that for April 1842 ; the least that for October 1841 ; the range being ^{in.} 0.574.

TABLE II.—Mean Height of the Barometer for periods of Three Month, for the Summer and Winter Months of 1842, and for the Year 1842.

Period.	20 ^h .	23 ^h .	2 ^h .	3 ^h .	• Mean of the Four Hours.
1841.	in.	in.	in.	in.	in.
July, Aug., Sept.	29.497	29.509	29.507	29.508	29.505
October, November	29.391	29.442	29.406	29.411	29.412
1842.					
Jan., Feb., March	29.563	29.573	29.552	29.556	29.561
April, May, June	29.805	29.798	29.763	29.749	29.779
July, Aug., Sept.	29.687	29.689	29.674	29.666	29.679
Oct., Nov., Dec.	29.583	29.600	29.596	29.596	29.594
Jan., Feb., March, } Oct., Nov., Dec. }	29.573	29.586	29.574	29.576	29.577
April, May, June, } July, Aug., Sept. }	29.746	29.743	29.718	29.707	29.729
The Year	29.660	29.665	29.646	29.642	29.653

A maximum seems to occur about 23^h in winter, and before 23^h in summer ; a minimum between 2^h and 5^h in winter, and nearer 5^h than 2^h in summer.

The pressure in the three months, July, August, and September 1841, is about as much greater than that in the two following months, as the pressure in the third quarter of 1842 is greater than that in the last quarter.

TABLE III.—Containing the Highest and Lowest Readings of the Barometer, corrected for Temperature, in each Month, as obtained from all the Observations.

Month.	Göttingen Mean Time.		Highest Barometer.	Göttingen Mean Time.		Lowest Barometer.	Range for the Month.	Mean of the Highest and Lowest.
	d.	h.		d.	h.			
1841.			in.			in.		in.
July	23	5	29.819	20	23	29.176	0.643	29.497
August	17 23 } 26 20 }		29.916	5	20	29.104	0.812	29.510
September	20	5	30.038	28	20	28.484	1.554	29.261
October	29	20	29.984	7	2	28.669	1.315	29.326
November	3	23	30.246	29	20	28.262	1.984	29.254
1842.								
January	18	5	30.136	26	5	28.509	1.627	29.322
February	15 20 } 15 23 }		30.203	25	19	28.821	1.382	29.512
March	22	23	30.113	19	5	28.898	1.215	29.505
April	15	23	30.154	1	2	29.072	1.082	29.613
May	15	20	30.276	7	5	28.539	1.737	29.407
June	11	23	30.187	25	5	28.950	1.237	29.568
July	14	23	30.127	4	20	28.987	1.140	29.557
August	15	23	30.097	10	20	29.334	0.763	29.715
September	29	2	30.245	9	5	29.035	1.210	29.640
October	8	2	30.304	22	5	28.631	1.673	29.467
November	17	5	30.249	24	20	28.553	1.696	29.401
December	8	23	30.263	25	20	28.764	1.499	29.513

The greatest height of the Barometer in the five months of 1841 was in November, in. 30.246.
 The least November, 28.262.
 The greatest twelve months ... 1842 October, 30.304.
 The least January, 28.509.

While there is no marked difference in the summer and winter ranges of pressure to be deduced from the means at the observation hours, the *extreme* ranges of pressure are markedly greater in winter than in summer. With two exceptions, the means of the highest and lowest are less than the means of the four hours.

TABLE IV.—Means of the Highest and Lowest Pressures in Table III.

Periods.	Highest.	Lowest.	Mean of Highest and Lowest.
	in.	in.	in.
Five Months of 1841	30.001	28.739	29.370
The same Five Months of 1842	30.204	28.908	29.556
The Year 1842	30.196	28.841	29.568

ABSTRACTS FOR THE BAROMETER.

TABLE V.—Monthly Means of the Height of the Barometer *minus* the Pressure of Aqueous Vapour.

Month.	20 ^h .	23 ^h .	2 ^h .	5 ^h .	Mean of the Four Hours.
1841.	in.	in.	in.	in.	in.
July	29.092	29.118	29.121	29.114	29.111
August	29.200	29.167	29.152	29.167	29.171
September	29.133	29.108	29.084	29.075	29.100
October	29.099	29.129	29.094	29.106	29.107
November	29.226	29.281	29.218	29.209	29.233
1842.					
January	29.402	29.417	29.368	29.369	29.389
February	29.374	29.390	29.377	29.417	29.389
March	29.278	29.261	29.237	29.218	29.248
April	29.750	29.717	29.651	29.628	29.686
May	29.339	29.314	29.254	29.263	29.292
June	29.435	29.409	29.399	29.376	29.405
July	29.311	29.288	29.261	29.254	29.278
August	29.303	29.285	29.288	29.273	29.287
September	29.316	29.297	29.254	29.250	29.279
October	29.453	29.446	29.433	29.410	29.435
November	29.217	29.224	29.214	29.215	29.217
December	29.338	29.370	29.372	29.395	29.369

The greatest mean pressure of the dry air occurs in April 1842, the least in September 1841; the range being 0.586, nearly the same as for the moist air.

TABLE VI.—Mean Height of the Barometer *minus* the Pressure of Aqueous Vapour, for periods of Three Months, for the Summer and Winter Months of 1842, and for the Year 1842.

Period.	20 ^h .	23 ^h .	2 ^h .	5 ^h .	Mean of the Four Hours.
1841.	in.	in.	in.	in.	in.
July, Aug., Sept.	29.142	29.131	29.119	29.119	29.128
October, November	29.162	29.205	29.156	29.157	29.170
1842.					
Jan., Feb., March	29.351	29.356	29.327	29.335	29.342
April, May, June	29.508	29.480	29.435	29.422	29.461
July, Aug., Sept.	29.310	29.290	29.268	29.259	29.282
Oct., Nov., Dec.	29.336	29.347	29.340	29.340	29.341
Jan., Feb., March, } Oct., Nov., Dec. }	29.343	29.351	29.333	29.337	29.341
April, May, June, } July, Aug., Sept. }	29.409	29.385	29.351	29.340	29.371
The Year.	29.376	29.368	29.342	29.339	29.356

A maximum in the pressure of the *dry* air occurs in the winter about 23^h, and in the summer nearer 20^h than 23^h.

A minimum occurs in the winter between 2^h and 5^h, and in the summer near 5^h?

The pressure of moist air, Table II., shews the same periods of maxima and minima.

The mean pressure of the dry air in summer differs much less from that in winter than in the case of moist air.

TABLE VII.—Containing the Monthly Means for the Dry and Wet Bulb Thermometers, at the Hours 20, 23, 2, and 5.

Month.	Dry Bulb Thermometer.					Wet Bulb Thermometer.			
	20 ^h .	23 ^h .	2 ^h .	5 ^h .	Mean of 20 ^h and 23 ^h .	20 ^h .	22 ^h .	2 ^h .	5 ^h .
1841.									
July	52.9	56.2	58.8	58.6	54.5	50.1	52.0	53.5	53.9
August	54.1	58.8	60.7	60.5	56.4	52.0	55.0	55.9	55.8
September	50.5	56.0	58.4	57.7	53.2	49.1	53.2	55.0	54.3
October	42.1	45.1	47.1	45.9	43.6	40.5	42.7	44.0	43.7
November	33.9	37.2	40.3	38.5	35.5	33.6	35.3	38.5	37.4
1842.									
January	34.1	34.4	36.7	35.2	34.2	32.9	33.3	35.0	34.0
February	37.7	39.7	42.9	41.5	38.7	36.4	37.6	39.8	38.9
March	39.5	43.5	45.3	44.7	41.5	37.7	40.7	42.0	41.4
April	40.5	48.9	53.9	53.5	44.7	38.6	44.6	47.6	47.6
May	48.9	53.8	57.4	56.6	51.3	47.5	50.5	52.8	51.9
June	54.9	60.4	63.8	62.9	57.6	51.1	54.3	55.9	55.5
July	54.3	59.4	62.1	61.8	56.8	51.8	54.8	56.3	56.2
August	57.0	63.2	66.8	66.5	60.1	54.8	58.2	59.9	59.8
September	51.2	56.4	59.5	58.7	53.8	49.5	52.9	54.6	54.2
October	40.9	46.6	49.6	47.8	43.7	39.1	42.7	44.2	43.7
November	38.1	40.3	43.6	42.0	39.2	36.9	38.3	40.8	39.7
December	45.4	45.9	47.2	45.7	45.6	43.6	44.1	44.7	43.7

The mean of 20^h and 23^h for the dry bulb thermometer is given as an approximate mean temperature for the month.

The means for the wet bulb in the month of May 1842 are not strictly comparable with those for the dry bulb in the same month, as the readings of the wet bulb for a considerable period in May have been rejected. See note, page 84.

TABLE VIII.—Containing the Monthly Means, &c., for the Maximum and Minimum Self-Registering Thermometers.

Month.	Mean of the Daily			Mean Daily Range.	Maximum of the Month.		Minimum of the Month.		Mean.	Range of the Month.
	Maxima.	Minima.	Max. and Min.		Day.	Temperature.	Day.	Temperature.		
1841.										
July	62.3	48.7	55.5	13.6	19	69.7	16	42.2	55.9	27.5
August	62.8	47.7	55.2	15.1	20	71.5	12	37.3	54.4	34.2
September	61.0	47.3	54.1	13.7	12	75.6	5	35.1	55.3	40.5
October	49.8	38.5	44.1	11.3	13	55.9	21	30.0	42.9	25.9
November	42.3	30.6	36.4	11.7	8	53.7	17	14.6	34.1	39.1
1842.										
January	37.0	27.6	32.3	9.4	19	43.6	23	18.4	31.0	25.2
February	44.2	33.1	38.6	11.1	11	50.0	6	22.1	36.0	27.9
March	47.9	34.8	41.3	13.1	24	55.9	8	30.0	42.9	25.9
April	55.9	33.3	44.6	22.6	21	66.8	8	27.2	47.0	39.6
May	61.4	41.8	51.6	19.6	13	66.9	2	28.8	47.8	38.1
June	66.9	46.8	56.8	20.1	13	80.8	2	36.4	58.6	44.4
July	65.1	47.4	56.2	17.7	23	78.1	6	38.4	58.2	39.7
August	68.6	51.2	59.9	17.4	18	82.3	24	36.7	59.5	45.6
September	61.8	47.3	54.5	14.5	14, 15	70.6	20	36.5	53.5	34.1
October	51.2	37.6	44.4	13.6	11	62.6	19	24.2	43.4	38.4
November	44.6	34.8	39.7	9.8	1	57.6	14	21.3	39.4	36.3
December	49.5	40.2	44.8	9.3	30	58.5	31	28.4	43.4	30.1

The maximum and minimum in the five months of 1841 are 75°·6 in September, and 14°·6 in November, the range being 61°·0. In the corresponding five months of 1842, they are 82°·3 in August, and 21°·3 in November, the range also being 61°·0.

TABLE IX.—Means of the Maxima and Minima of Temperature for periods of Three Months, &c.

Periods.	Mean of Daily			Mean Daily Range.	Mean of Monthly			Mean Monthly Range.
	Max.	Min.	Max. and Min.		Max.	Min.	Max. and Min.	
1841.								
July, Aug., Sept.	62.0	47.9	54.9	14.1	72.3	38.2	55.2	34.1
Oct., Nov.	46.0	34.5	40.2	11.5	54.8	22.3	38.5	32.5
1842.								
Jan., Feb., March	43.0	31.8	37.4	11.2	49.8	23.5	36.6	26.3
April, May, June	61.4	40.6	51.0	20.8	71.5	30.8	51.1	40.7
July, Aug., Sept.	65.2	48.6	56.9	16.6	77.0	37.2	57.1	39.8
Oct., Nov., Dec.	48.4	37.5	42.9	10.9	59.6	24.6	42.1	35.0
The Year	54.5	39.7	47.1	14.8	64.5	29.0	46.7	35.5

The mean of the monthly maxima and minima for the third quarter of 1841, and for the second and third quarters of 1842, is 0.2 greater than the mean of all the daily maxima and minima for the same periods. The mean of the monthly maxima and minima in the first and last quarters of 1842, is in each case 0.8 less than the mean of all the daily maxima and minima for the same periods.

The mean of the maximum and minimum in each month of 1842 is 0.4 less than the mean of all the daily maxima and minima in 1842.

TABLE X.—Monthly Means of the Pressure of Aqueous Vapour.

Month.	20 ^h .	23 ^h .	2 ^h .	5 ^h .	Mean of the Four Hours.
1841.	in.	in.	in.	in.	in.
July	0.343	0.352	0.361	0.373	0.357
August	.376	.399	.401	.402	.394
September	.346	.384	.403	.393	.381
October	.251	.263	.269	.276	.265
November	.207	.212	.232	.231	.220
1842.					
January	.192	.194	.200	.199	.196
February	.218	.219	.229	.224	.222
March	.224	.239	.246	.241	.237
April	.230	.261	.272	.277	.260
May	.317	.329	.348	.338	.333
June	.345	.364	.366	.366	.360
July	.369	.388	.396	.397	.387
August	.415	.436	.443	.444	.434
September	.348	.372	.381	.380	.370
October	.239	.249	.245	.255	.247
November	.223	.227	.240	.235	.231
December	.280	.285	.283	.278	.281

In forming the above Table, only those observations of the dry bulb thermometer were used which had corresponding observations of the wet bulb.

In the computations, Dr Apjohn's formula was used approximately, viz., $f'' = f' - \frac{d}{88}$; 96 being substituted for 88 for temperatures below 32°. The values of f' were taken from the Table page xi. Introduction to the Greenwich Meteorological Observations for 1842.

TABLE XI.—Means of the Pressure of Aqueous Vapour for periods of Three Months, for the Summer and Winter Months 1842, and for the Year 1842.

Period.	20 ^h .	23 ^h .	2 ^h .	5 ^h .	Mean of the Four Hours.
1841.	in.	in.	in.	in.	in.
July, Aug., Sept.	0.355	0.378	0.388	0.389	0.377
Oct., Nov.	.228	.237	.250	.253	.242
1842.					
Jan., Feb., March	.211	.217	.225	.221	.218
April, May, June	.297	.318	.329	.327	.318
July, Aug., Sept.	.377	.399	.407	.407	.397
Oct., Nov., Dec.	.247	.254	.256	.256	.253
Jan., Feb., March, } Oct., Nov., Dec. }	.229	.235	.241	.239	.236
April, May, June, } July, Aug., Sept. }	.337	.358	.368	.367	.357
The Year	.283	.297	.304	.303	.297

The maximum pressure occurs between 2^h and 5^h, and it is greater in summer than in winter.

TABLE XII.—Monthly Means of the Relative Humidity, or of the ratio $\frac{\text{Pressure of Aqueous Vapour}}{\text{Pressure at Saturation}}$ for the Observation Hours, 20, 23, 2, and 5.

Month.	20 ^h .	23 ^h .	2 ^h .	5 ^h .	Mean of the Four Hours.
1841.					
July	0.833	0.764	0.718	0.748	0.766
August	.876	.793	.748	.756	.793
September	.911	.838	.812	.811	.843
October	.884	.832	.796	.852	.841
November	.949	.891	.864	.898	.900
1842.					
January	.889	.884	.839	.884	.874
February	.895	.836	.782	.803	.829
March	.862	.799	.774	.775	.802
April	.855	.725	.638	.658	.719
May	.854	.744	.704	.710	.753
June	.782	.687	.617	.635	.680
July	.854	.756	.706	.715	.758
August	.877	.749	.676	.685	.747
September	.895	.802	.740	.758	.799
October	.864	.749	.666	.737	.754
November	.897	.847	.800	.863	.852
December	.873	.880	.835	.863	.863

ABSTRACTS FOR HUMIDITY, WIND, AND CLOUDS.

TABLE XIII.—Mean Relative Humidity for periods of Three Months, for the Summer and Winter Months 1842, and for the Year 1842.

Periods.	20 ^h .	23 ^h .	2 ^h .	5 ^h .	Mean of the Four Hours.
1841.					
July, Aug., Sept.	0.873	0.798	0.759	0.772	0.800
October, November	.916	.861	.830	.875	.870
1842.					
Jan., Feb., March	.882	.840	.798	.821	.835
April, May, June	.830	.719	.653	.668	.717
July, Aug., Sept.	.875	.769	.707	.719	.767
Oct., Nov., Dec.	.878	.825	.767	.821	.823
Jan., Feb., March, } Oct., Nov., Dec. }	.880	.832	.782	.821	.829
April, May, June, } July, Aug., Sept. }	.852	.744	.680	.693	.742
The Year.	.866	.788	.731	.757	.785

The humidity is least about 2^h in winter, and between 2^h and 5^h in summer; and is less in summer than in winter.

TABLE XIV.—Force of Wind at the Observation Hours, and Maximum Force between the Observation Hours.

Month.	20 ^h .	23 ^h .	2 ^h .	5 ^h .	5 ^h and 20 ^h .	20 ^h and 23 ^h .	23 ^h and 2 ^h .	2 ^h and 5 ^h .
	lbs.	lbs.	lbs.	lbs.	lbs.	lbs.	lbs.	lbs.
May	0.3	0.4	0.6	0.4				
June	0.3	0.4	0.6	0.5				
July	0.5	0.6	0.9	0.7				
August	0.4	0.6	0.7	0.7				
September	0.4	0.6	0.8	0.7				
October	0.4	0.8	0.8	0.6				
November	0.4	0.4	0.5	0.3	1.2	0.8	1.0	1.1
December	1.2	1.2	1.0	1.1	3.2	2.1	2.2	1.8
Means	0.5	0.6	0.7	0.6	2.2	1.4	1.6	1.4

The force of wind was estimated from May till the 21st of October, afterwards the pressures are from the Anemometer. The quantities from the Anemometer are lbs. pressure on the square foot of surface; the estimations have nearly the same value.

A maximum seems to occur about 2^h.

TABLE XV.—Mean quantity of Clouds from May till December 1842 at the Observation Hours.

Month.	20 ^h .	23 ^h .	2 ^h .	5 ^h .	Mean of the Four Hours.
May	7.5	6.5	6.6	6.5	6.8
June	6.0	6.3	5.5	6.6	6.1
July	8.1	8.1	8.1	6.7	7.7
August	7.4	7.9	7.3	7.3	7.5
September	8.2	8.8	8.4	7.1	8.1
October	6.3	5.5	6.2	7.3	6.3
November	8.0	7.6	7.8	8.5	8.0
December	7.4	7.2	7.0	7.5	7.3
Means	7.4	7.2	7.1	7.2	7.2

A maximum in the quantity of clouds seems to occur about 23^h in the months of June, July, August, and September, and a minimum about the same hour in the other months. The means for the 8 months at all the hours are almost exactly those for the month of December.

TABLE XVI.—Quantity of Rain for each Month at Makerstoun, from 1832 till 1842.

Month.	1832.		1833.		1834.		1835.		1836.		1837.		1838.		1839.		1840.		1841.		1842.		Means.		
	C.		C.		C.		C.		C.		C.		C.		C.		C.		C.		A.		1832 to 1842.		
	in.	?	in.	in.	in.	in.	in.	in.	in.	in.	in.	in.	in.	in.	in.	in.	in.	in.	in.	in.	in.	in.	in.	in.	in.
January	1.5	0.40	3.19	0.04	1.88	2.87	1.86	1.47	1.59	0.77	1.84	2.33	1.29	1.64	1.09	1.849	2.222	1.387							
February	1.29	1.97	1.05	2.84	2.53	1.43	0.93	0.57	0.95	0.63	1.46	1.08	0.72	1.31	0.98	1.559	1.245	0.818							
March	0.71	2.77	0.73	1.25	2.23	1.93	1.23	1.16	1.92	2.06	0.51	0.99	1.78	2.24	1.78	1.614	1.677	1.288							
April	0.83	1.14	1.23	0.68	1.45	2.84	2.18	1.50	0.28	0.28	0.01	1.78	1.47	0.08	0.05	1.081	1.093	0.857							
May	1.95	3.41	0.81	1.67	1.67	1.02	0.82	1.81	4.08	3.78	2.17	2.00	1.72	2.58	2.48	2.48	2.14	1.49	1.13	1.75	1.437				
June	4.37	3.41	1.79	0.47	2.14	2.05	1.93	4.08	3.78	2.17	2.00	1.72	2.58	2.48	2.14	1.49	1.24	2.488	2.532	2.185					
July	0.53	1.83	3.55	0.86	3.96	5.30	5.01	2.37	2.52	2.34	2.01	1.64	1.91	3.85	3.53	1.88	1.74	2.201	2.637	2.558	2.300				
August	3.74	1.31	3.70	2.00	2.91	2.96	2.64	2.52	2.90	2.79	3.94	3.41	2.93	2.49	3.41	2.93	2.75	2.49	3.080	2.632	2.998	2.617			
September	1.18	2.13	2.97	2.75	1.93	2.06	1.75	2.90	2.90	2.79	3.09	2.21	4.80	1.19	0.93	1.319	2.590	2.517	2.038						
October	3.43	1.88	2.04	2.96	3.08	1.25	0.96	2.25	1.74	1.77	1.82	1.59	2.03	2.43	2.34	1.84	1.43	1.846	2.300	2.135	1.763				
November	2.97	1.20	1.70	3.61	3.01	1.43	1.15	1.98	1.77	1.86	2.61	1.89	1.41	1.56	1.07	1.872	1.415	1.080							
December	1.61	3.75	1.21	1.28	4.25	1.82	1.56	0.43	0.61	1.34	0.67	1.83	1.41	1.56	2.102	1.872	1.415	1.080							
Sums	24.11	22.60	23.82	20.41	29.83	26.96	22.02	25.06	21.02	18.25	24.95	29.33	23.92	19.80	16.04	24.565	24.907	20.288							

From the observations of C. for 11 years, April is the driest month, and August and September the wettest months. The mean for the three months

February, March, April, is 1.418
 May, June, July, ... 2.144
 August, September, October, ... 2.620
 November, December, January, ... 2.007

The greatest quantity of rain fallen in any month from 1832 till 1842 by the gauge C. was in October 1841, 5.50; the least for the same period and gauge was in January 1835, 0.04.

The greatest quantity of rain fallen in any year from 1832 till 1842 by the gauge C. was in 1836, 29.83; the least quantity for a year was in 1842, 19.80.

The quantity of rain, January 1832, is estimated.

The quantities of rain for the gauge B., January and February 1837, and for C. in 1839, are estimated from the quantities given by the other gauge for the purposes of summation.

TRANSACTIONS
OF THE
ROYAL SOCIETY
OF
EDINBURGH.

VOL. XVII.—PART II.

CONTAINING THE
MAKERSTOUN MAGNETICAL AND METEOROLOGICAL
OBSERVATIONS

FOR

1843.

EDINBURGH:
PUBLISHED BY ROBERT GRANT & SON, 82 PRINCES STREET; AND
T. CADELL, STRAND LONDON.

MCCCXLIII

PRINTED BY NEILL AND CO., OLD FISHMARKET, EDINBURGH.

OBSERVATIONS

IN

MAGNETISM AND METEOROLOGY,

MADE AT

MAKERSTOUN IN SCOTLAND,

IN THE OBSERVATORY OF

GENERAL SIR THOMAS MAKDOUGALL BRISBANE, BART.,

G.C.B., G.C.H., D.C.L., LL.D., F.R.S., F.R.A.S., H.M.R.I.A., PRESIDENT OF THE ROYAL SOCIETY OF EDINBURGH,
AND CORRESPONDING MEMBER OF THE INSTITUTE OF FRANCE,

IN 1843.

DISCUSSED AND EDITED BY

JOHN ALLAN BROUN, Esq.,

DIRECTOR OF THE OBSERVATORY.

EDINBURGH:

PRINTED BY NEILL AND COMPANY.

MDCCCXLVII.

CONTENTS.

	PAGE
INTRODUCTION—	
Position and Description of the Observatory,.....	ix
System of Observation and Personal Establishment,	xi
MAGNETICAL INSTRUMENTS—	
<i>Declinometer—</i>	
Description of the Declinometer,	xii
Values of the Scale Divisions,	xiii
Scale Reading for the Magnetic Axis,.....	xv
Correction for the effects of the Bifilar and Balance Magnets,	xvi
Correction for the effect of the Copper Ring or Damper,	xvii
Correction for the Non-Parallelism of the faces of the Plates of Glass in the Box,	xviii
Correction for the Torsion Force of the Suspension Thread,	xviii
Facts relating to the Suspension Threads,	xix
Accidental Sources of Error.....	xx
Adopted Scale Zeros.....	xxi
Time of Vibration of the Declination Magnet	xxi
Absolute Magnetic Declination	xxii
<i>Unifilar Magnetometer and Observations of the Absolute Horizontal Intensity of the Earth's Magnetism—</i>	
Position and Description of the Instrument,	xxiii
Mode of Observation and Reduction,	xxiv
Observations of Absolute Horizontal Intensity,	xxvi
<i>Bifilar or Horizontal Force Magnetometer—</i>	
Description of the Instrument,.....	xxix
Adjustments and Values of Constants,	xxxi
Constants for Reduction after altering the Reading of the Torsion Circle,.....	xxxiii
Corrections for the effects of the Declination and Balance Magnets,	xxxiv
Time of Vibration of the Bifilar Magnet,	xxxiv
Mode of Observation,.....	xxxiv
Temperature of the Magnet,.....	xxxiv
<i>Balance or Vertical Force Magnetometer—</i>	
Description and Theory of the Instrument,	xxxv
Practical difficulties in Dr LLOYD's method of determining the Constants,.....	xxxvi
New method of determining the Constants (Note),	xxxvi
Another method (that used in this volume) of determining the Constants,	xxxvii
Values of Constants and Adjustments,	xxxviii
Time of Vibration of the Balance Needle,	xxxviii

	PAGE
<i>Determination of the Temperature Coefficients of the Magnets—</i>	
Temperature Coefficient of the Deflection Magnet.....	xlii
Temperature Coefficient of the Balance Magnet,	xliii
Temperature Coefficient of the Bifilar Magnet,	l
<i>Inclinometer—</i>	
Description of the Instrument	liii
Facts relating to Observations,.....	liv
METEOROLOGICAL INSTRUMENTS—	
<i>Barometer—</i>	
Description of the Instrument,	lv
Corrections applied to the Observations,.....	lv
<i>Thermometers—</i>	
Description and Position of the Dry and Wet Bulb Thermometers,	lvi
Position of Maximum and Minimum Register Thermometers,.....	lvii
Corrections for Thermometers	lvii
<i>Rain-Gauges—</i>	
Description and Positions of the Rain-Gauges,	lviii
<i>Anemometer—</i>	
Position and Description of the Anemometer,	lviii
Mode of Observation,	lx
STATE OF THE SKY—	
Mode of estimating the Surface and Motions of Clouds,	lx
CLOCK, STOVE, AND COMPUTING ROOM—	
Mean Time Clock,	lx
Stove and Computing Room,	lx
DESCRIPTION OF THE TABLES OF OBSERVATIONS—	
Description of Tables containing the Daily Observations of Magnetometers,.....	lxi
Description of Tables containing the Term-Day Observations of Magnetometers,...	lxii
Description of Tables containing the Extra Observations of Magnetometers,	lxii
Description of Tables containing the Daily Meteorological Observations,	lxii
Description of Tables containing the Term-Day and Extra Meteorological Observations,	lxiii
Reference to Tables of Abstracts,	lxiv
Account of the method adopted in Projecting and Printing the Curves of Term-Day Observations,	lxiv
GENERAL REMARKS—	
Reasons for the methods adopted in Reducing and Printing the Magnetical Observations,	lxiv
POSTSCRIPT—	
New method of determining the Value of the Scale Divisions of the Bifilar Magnetometer in Parts of the whole Horizontal Force,	lxv
Results of Experiments in which the new method was employed,	lxvi

CONTENTS.

v

MAGNETICAL OBSERVATIONS—

PAGE

DAILY OBSERVATIONS OF MAGNETOMETERS,	1
TERM-DAY OBSERVATIONS OF MAGNETOMETERS,	29
EXTRA OBSERVATIONS OF MAGNETOMETERS,	49
OBSERVATIONS OF MAGNETIC DIP,	75
OBSERVATIONS OF ABSOLUTE HORIZONTAL INTENSITY,	79

METEOROLOGICAL OBSERVATIONS—

DAILY METEOROLOGICAL OBSERVATIONS,	85
TERM-DAY AND EXTRA METEOROLOGICAL OBSERVATIONS,	199

ABSTRACTS OF THE RESULTS OF THE MAGNETICAL OBSERVATIONS, 219

ABSTRACTS FOR THE MAGNETIC DECLINATION—

Annual Period,	221
Variations with reference to the Position of the Moon,	223
Secular Change,	224
Diurnal Variation,	225
Ranges of the Variations with reference to the Sun,	229
Ranges of the Variations with reference to the Position of the Moon,	229

HORIZONTAL COMPONENT OF MAGNETIC FORCE—

Annual Period,	230
Variations with reference to the Position of the Moon,	232
Secular Change,	234
Diurnal Variation,	235
Ranges of the Variations with reference to the Sun,	236
Ranges of the Variations with reference to the Moon,	238

VERTICAL COMPONENT OF MAGNETIC FORCE—

Annual Period,	240
Variations with reference to the Position of the Moon,	241
Diurnal Variation,	243
Secular Change,	245
Ranges of the Monthly Means of the Diurnal Variation,	245
Diurnal Ranges with reference to the Position of the Moon,	247

MAGNETIC DIP—

Secular Change,	247
Annual Period,	247
Diurnal Variation,	248
Ranges of the Monthly Means of the Diurnal Variation,	249
Variations with reference to the Position of the Moon,	250

TOTAL MAGNETIC FORCE—

Secular Change,	251
Annual Period,	251
Diurnal Variation,	252
Ranges of the Monthly Means of the Diurnal Variation,	253
Variations with reference to the Position of the Moon,	253

	PAGE
EXTREME POSITIONS—	
During the Daily Observations ; with the Ranges,	254
During observed Disturbances ; with the Ranges,.....	255
During Term-Days ; with the Ranges,.....	256
Mean Positive and Negative Excesses of the Extreme Excursions of the Three Magnets,	257
Of the Daily Means,	258
Extreme Values of the Diurnal Ranges,.....	259
INCLINOMETER—	
Monthly Means of the Observed Magnetic Dip,	259
ABSTRACTS OF THE RESULTS OF THE METEOROLOGICAL OBSERVA- TIONS,	
	261
TEMPERATURE OF THE AIR—	
Annual Variation,	263
Diurnal Variation,.....	264
Approximations to the Monthly Means from Two Observations,	265
Diurnal Ranges	267
Extreme Temperatures,	267
TEMPERATURE OF EVAPORATION—	
Annual Variation,	268
Diurnal Variation,.....	269
Range of the Diurnal Variation,.....	269
PRESSURE OF AQUEOUS VAPOUR—	
Annual Variation,	270
Variations with reference to the Position of the Moon,	271
Extreme Daily Means ; with the Ranges.....	271
Diurnal Variation,	272
Range of the Diurnal Variation,	273
RELATIVE HUMIDITY—	
Annual Variation,	274
Extreme Daily Means ; with the Ranges,	274
Variations with reference to the Position of the Moon,	275
Diurnal Variation,	275
Range of the Diurnal Variation,	276
ATMOSPHERIC PRESSURE—	
Annual Variation,	277
Variations with reference to the Position of the Moon,.....	278
Diurnal Ranges,.....	279
Diurnal Variation,	280
Range of the Diurnal Variation,	280
Extreme Readings and Daily Means ; with the Ranges,	281
PRESSURE OF DRY AIR—	
Annual Variation,	282
Diurnal Variation,	283
Extremes of the Daily Means ; with the Ranges,.....	285

CONTENTS.

vii

	PAGE
PRESSURE AND DIRECTION OF THE WIND—	
Annual Variation of the Maximum Pressures	286
Annual Variation of the Approximate Means	287
Daily Maxima,	288
Diurnal Variation of the Maximum Pressures,	289
Diurnal Variation of the Approximate Means,	290
Monthly Maxima,	291
Annual Variation of the Number of Times which the Wind blew in 1843,.....	294
Annual Variation of the Number of the Points of the Compass in which the Wind blew,	294
Annual Variation of the Sums of Pressures,.....	294
Annual Variation of the Mean Pressure <i>while</i> blowing,	294
Annual Variation of the Resultant Pressure,	295
Direction of the Resultant,	295
Diurnal Variation of the Number of Times which the Wind blew,.....	298
Diurnal Variation of the Number of the Points of the Compass in which the Wind blew,	298
Diurnal Variation of the Sums of Pressures,.....	298
Diurnal Variation of the Mean Pressure <i>while</i> blowing,	298
Times which the Wind blew from different Points,	299
Sums of the Pressures with which the Wind blew from different Points,	299
Mean Pressure <i>while</i> blowing from different Points,	299
Diurnal Variation of the Resolved Pressures in N. E. S. and W., and of the Re- sultant,.....	300
Diurnal Variation of the direction of the Resultant,.....	300
MOTIONS OF THE CLOUDS—	
Differences of the Motions of the Upper and Lower Currents of Air,.....	300
SURFACE OF CLOUD—	
Annual Variation,	302
Variation with reference to the Position of the Moon,	303
Extremes of the Daily Means,	303
Diurnal Variation,.....	304
RAIN—	
Monthly Sums,	305
Monthly Extremes,.....	305
Number of rainy days,	305
Average daily fall for each Month,	305

ERRATA IN THIS VOLUME OF OBSERVATIONS FOR 1843.

Page xxxi., Introduction, *for* 1·1223 *read* 1·1233

- 14, June 22^d 2^h, Balance Magnetometer, *for* 645·6 *read* 641·6, and *for* 65·3 *read* 64·8
- 18, Aug. 25^d 22^h, Declinometer, *for* 22·08 *read* 22·20
- 25, Nov. 24^d 18^h, Bifilar Magnetometer, *for* 521·9 *read* 522·2
- 25, Nov. 24^d 20^h, Balance Magnetometer, *for* 838·2 *read* 837·4
- 30, 14^h 0^m, Bifilar Reading, *for* 557·2 *read* 537·2
- 41, 9^h 0^m, Balance Reading, *for* 80·63 *read* 806·3
- 44, 19^h 5^m, Bifilar Reading, *for* 815·1 *read* 515·1
- 44, 18^h 10^m, Declination Reading, *for* 15·54 *read* 17·56
- 46, 14^h 30^m, Bifilar Reading, *for* 217·2 *read* 517·2
- 54, Mar. 7^d 7^h 53^m, Balance Reading, *for* 004·1 *read* 1004·1
- 54, Mar. 7^d 8^h 13^m, Balance Reading, *for* 1976·7 *read* 976·7
- 54, Mar. 12^d 7^h 15^m, Balance Minute of Observation, place 15 before 1070·0
- 67, July 25^d 10^h 23^m, Balance Reading, *for* 826·6 *read* 626·6
- 73, first line of figures, 8th column, *for* Dec. 28^d 2^h *read* Dec. 28^d 3^h
- 86, Jan. 4^d, col. Max. and Min., *for* 26·5 *read* 34·0 ?
- 146, July 21^d 8^h, col. Diff., *for* 3·1 *read* 2·9
- 170, Oct. 8^d 18^h, col. Barometer, *for* 30·229 *read* 29·229

ERRATA IN THE VOLUME OF OBSERVATIONS FOR 1841 AND 1842.

Page xv., Introduction, 6th line from foot, *delete* between.

- xx., ——— lines 8 and 2 from foot, *for* A *read* A'
- xx., ——— last line, after A add = 180° - A'
- xxxv., ——— last line but one *for* 2° 30' *read* 12° 30'
- 137, Table III., *delete* 25° below Range.

INTRODUCTION.

DESCRIPTIONS OF INSTRUMENTS, ADJUSTMENTS, AND DATA FOR REDUCTIONS.

§ 1. POSITION AND DESCRIPTION OF THE OBSERVATORY.

1. The Magnetical and Meteorological Observatory at Makerstoun, in Roxburghshire, was erected by General Sir THOMAS MAKDOUGALL BRISBANE, Bart., in the year 1841. The geographical co-ordinates are as follow :—

Latitude,	55° 34' 45" N.*	
Longitude,	0 ^h 10 ^m 3·5 ^s W. of Greenwich.†	

Height of the barometer cistern above mean water at Berwick, 213 feet.

The last ordinate was obtained by connecting the Astronomical Observatory with levels made from Berwick to the opposite bank of the Tweed, for a railway from Berwick to Melrose. This determination has been verified by the results of many series of barometrical observations, made simultaneously at Berwick and Holy Island by Sir T. M. BRISBANE, and at Makerstoun by Miss M. BRISBANE. The following are examples of the results taken at random :—

Height of the cistern of the barometer in Sir T. M. BRISBANE'S library above mean water at

					Feet.
Berwick,	Aug. 21, 22	1837, 10 Comparisons,	. . .		221·6
Holy Island,	Oct. 9, —4 P.M.	1839, 1		226·2
... ..	Oct. 10, 16—9 A.M.	... 6		229·7
... —Noon,	... 6		227·1
... —3 P.M.	... 4		229·3
... 2		220·9

Giving the results weights depending on the number of comparisons, the mean is	225·6
The correction to the Observatory barometer cistern (by levels)	— 12·0
Height of Observatory cistern,	213·6

* Ast. Nach., vol. x. p. 214.

† Mem. Ast. Soc., vol. xi. p. 171.

Comparisons of simultaneous observations made at the Edinburgh Observatory by the late Professor HENDERSON, and at the Makerstoun Observatory, gave the difference of heights of the barometer cisterns :—

	Feet.
Edinburgh Observatory <i>minus</i> Makerstoun Observatory,	130
Height of the Edinburgh barometer cistern above mean water at Leith (by levels),	352
Height of Makerstoun barometer cistern,	222

2. The Magnetic Observatory is situate nearly on the summit of a ridge, which occupies the left or northern bank of the Tweed, being 540 feet distant from, and 80 feet above that river. The Astronomical Observatory is upon the highest part of the ridge, 140 feet due west of the Magnetic Observatory. A fair horizon is seen from the Observatory hill, being bounded about 10 miles to the east by a slightly swelling ground, which, to the east-south-east, seems to join the Cheviot Hills. The view is bounded about a mile to south and south-west by a ridge, forming the right bank of the Tweed; about 500 feet to the south-west and north-west by masses of trees in the Makerstoun grounds; and from 1 to 3 miles to north-west, north, and north-east, by an elevated ridge, which forms, to some extent, the northern boundary of the valley of the Tweed. From north, by the east, to the south, the elevation of the horizon, with a slight exception, is under 2° ; from the north to the north-west, increasing from 2° to 4° ; from the north-west to the south-west, the tops of the trees are elevated from 5° to 8° ; and from the south-west to the south the elevation is under 4° . The highest point of the Cheviots, which is 2656 feet above the level of the sea, is about 18 miles to the east-south-east; it is occasionally referred to in the meteorological remarks on clouds.

3. The Observatory hill, it is believed, is composed of felspathic trap. The Tweed, immediately to the south, and for a mile to the east and west, flows more or less through this rock, which does not appear upon any part of the hill. The opening for a foundation to the Observatory shewed only masses of rolled pebbles, and boulders of greywacke and trap.

4. The Observatory is rectangular in its plan, 40 feet by 20 feet internally. It is formed of wood; copper nails were used; and iron carefully excluded from every part of the structure. The pillars for the magnetometers and telescopes are of stone, from 22 inches to 19 inches in diameter, and are placed upon excellent stone foundations, completely disconnected with the floor, and every part of the building. By a reference to the plan and elevation, the following details will be understood. (Plate I.)

There are two windows to the south, with the door between; and three to the north, which open like folding doors. The dimensions of the principal apartment are, 40 feet long, 12 feet broad, and 12 feet high. The two ante-rooms are each 15 feet long, 7 feet broad, and 12 feet high. The instruments are indicated in the plan as follows :—

- D, The Declinometer.
 - t*, Its Reading Telescope.
- A, The Azimuth Circle and Transit.
- H, The Bifilar or Horizontal Force Magnetometer.
 - t'*, Its Reading Telescope.
 - P, A Pillar for a Collimator (not used).
- V, The Balance or Vertical Force Magnetometer.
- I, The Inclinometer.
- B, The Standard Barometer.
- W, The Anemometer.
- W', The Wind Vane Dial-Plate.
- T, The Thermometer Case.
- C, The Mean Time Clock.
- S, The Copper Stove.
- n s*, The Astronomical Meridian.
- D t*, The Magnetical Meridian.

The two vanes to the right in the elevation are those for the direction and force of the wind ; the other two were added after 1843.

§ 2. SYSTEM OF OBSERVATION, AND PERSONAL ESTABLISHMENT.

5. The system of observation followed in 1841 and 1842 consisted of four daily observations of the magnetical and meteorological instruments, at the hours of 8 and 11 A.M., and 2 and 5 P.M., hours recommended by Dr LLOYD for one permanent observer ;* of term observations, made once a month for 24 hours ; of observations of magnetic dip ; and of extra magnetical observations, made during marked magnetic disturbances. The personal establishment in 1841 and 1842 consisted of one permanent observer, and three assistants on term-days. It seemed desirable to render the daily observations somewhat more complete ; and as this would also necessarily entail a greater amount of labour in reductions, Sir THOMAS BRISBANE, on my suggestion, through Professor FORBES, and with his advice, added another permanent observer to the establishment. Mr JOHN WELSH, a student in Arts of the Edinburgh University, was appointed in the end of December 1842. The term-assistants in 1843 were Messrs HOGG and DODS, who assisted in the previous year. In 1843, the daily observations were made at every *even* hour of Göttingen mean time, from 6 A.M. till 10 P.M., or at every two hours, from 5^h 10^m A.M. till 9^h 10^m P.M., Makerstoun mean time. The other observations consisted of term-

* The observer had also the charge of a Transit Instrument, and of several Sidereal Clocks, which were compared daily.

day and extra magnetical and meteorological observations, of observations of magnetic dip, and of the absolute horizontal magnetic force.

It will be allowable for me to express here, how much I owe, in the conduct of the Observatory, to the unceasing kindness of its founder and supporter, Sir THOMAS BRISBANE, as well as to his suggestions, and his uniform attention to every proposal that might in any way tend to the advancement of science. I owe a like acknowledgment to Professor J. D. FORBES, and also to Dr H. LLOYD.

§ 3. DECLINOMETER.

6. The declination magnetometer was obtained from GRUBB of Dublin. The magnet is 15 inches long, $\frac{7}{8}$ inch broad, and $\frac{1}{4}$ inch thick. It fits into a stirrup, whose two eyes receive an axle attached to the suspension thread. Near the north extremity, it carries a scale divided on glass; near the other (about 12 inches, the focal length, distant from the scale) a lens of $1\frac{1}{4}$ inch diameter. A marble slab, cemented to the top of the declinometer-pillar, carries two copper tubes, 35 inches long, which are connected at the top by a mahogany tie, bearing the torsion-circle and the suspension apparatus; and, about 7 inches from the slab, by another wooden cross-piece, which supports a glass tube enclosing the suspension thread; the latter cross-piece, together with two glazed lids, fitting on a wooden drum, completes the enclosure of the suspended magnet, and of the copper ring used for checking the vibrations of the magnet. There are two glazed apertures in the sides of the box; one to the north, where a small mirror throws in light upon the glass scale; the other to the south, between the lens and the reading telescope. Previously to September 1843, the glazed lids fitted loosely on the box, and the latter did not rest closely on the marble slab, so that the magnet was probably affected by external currents of air. In June 1843, a rectangular pasteboard box, open at the extremities, was placed within the cylindrical box and round the magnet, which would have some effect in destroying internal currents: in September 1843, a wooden box was substituted, formed of two pieces fitting into each other in the middle by a groove and tongue, glazed at the extremities, and having only a small aperture for the suspension thread: at the same time, all the joints of the outer box, as well as the lower edge of the inner box, were covered with velvet, and the boxes were pressed firmly against the marble slab by means of leaden weights, which were previously determined to have no effect on the position of the magnet. In order, also, to destroy any effect of radiation in the formation of aerial currents, both boxes were covered with gilt paper, internally and externally.

7. The pillar of the azimuth circle and transit used for determinations of the absolute declination, is between the pillars of the magnetometer and its reading telescope. The theodolite is by TROUGHTON; the circle is 15 inches in dia-

meter, is divided to 5 minutes, and is read to 5 seconds with the three verniers. By some accident, the circle has probably been flattened on one side, as there the verniers enter rather too much on the graduations; the error due to this is, however, very small. The lines of collimation of the theodolite and reading telescopes coincide when the middle wire of the former is made to coincide with the vertical wire of the latter. The circle is retained in the same position on its pillar, but the transit telescope is removed, excepting when required for observations of absolute declination. The reading telescope is fixed to its pillar. Following are the determinations of the data requisite in reducing the observations of the declinometer.

8. Value of the declinometer scale divisions in angular measure.

The scale generally used consists of 500 divisions; but, during observations of absolute horizontal intensity, the magnet with this scale is removed to the unifilar magnetometer, and a magnet with a scale of 300 divisions is substituted in the declinometer. The observations, Table 2, *Introduction*, for 1841–2, gave one division of the long scale = 0·6710. Observations were also made on December 2, 4, and 5, 1843, and on October 22, 1844. The results were as follow:—

Dec. 2. 1843. Two series of observations, only one vernier of the circle read.

1st series; measures of 200 divisions; one division of the long scale = 0·6725
 2d, = 0·6725

These results were obtained after applying a correction on account of the non-coincidence of the graduations of the vernier with those of the circle.

Dec. 4. 1843. One series; measures of 100 divisions; one vernier read; one division of the long scale = 0·6728.

Dec. 5. 1843. Before the previous observation, it was found that the lens of the collimator was somewhat loose; it was then, it is believed, made more so. This was owing to the frame not being screwed hard up into the collar, which was now done.

One series; one vernier read; measures of 100 divisions; one division of the long scale

$$= \left\{ \begin{array}{l} 0\cdot6715 \\ 0\cdot6721 \end{array} \right\}; \text{ observer } \left\{ \begin{array}{l} \text{B.} \\ \text{W.} \end{array} \right.$$

Oct. 22. 1844. Owing to the difference of the results on Dec. 5. 1843, from those on the previous occasions, the following short series of observations were made with much care. All the three verniers were read, the readings being made first with the right and then with the left eye; the mean of the two being taken as the true reading.

TABLE 1.—Values of one of the Long Scale Divisions.

Observer B.					Observer W.				
Scale Division.	Mean of three Verniers.	Scale Division.	Mean of three Verniers.	Value of one Division.	Scale Division.	Mean of three Verniers.	Scale Division.	Mean of three Verniers.	Value of one Division.
160	55 18 46.25	260	54 11 34.17	0.67201	180	54 59 9.17	280	53 51 51.25	0.67300
170	55 12 4.17	270	54 4 50.21	67233	190	54 52 22.50	290	53 45 7.50	67250
180	55 5 20.83	280	53 58 2.50	67305	200	54 45 38.33	300	53 38 25.00	67222

1st series, observer B ; one long scale division = 0.67247

2d series, observer W ; = 0.67257

The adopted mean value of one division of the long scale of 500 divisions = 0.6725.*

Aug. 5. 1843. A short series of observations was made to determine the value of one division of the short scale of 300 divisions.

Three verniers read ; measures of 50 divisions ; one division of the short scale

$$= \left\{ \begin{array}{l} 0.7504 \\ 0.7502 \end{array} \right\} ; \text{observer } \left\{ \begin{array}{l} \text{B.} \\ \text{W.} \end{array} \right.$$

Nov. 29. 1843. Two series of observations were made with one vernier. The readings in the following Table are the means of the readings by Mr WELSH and myself.

TABLE 2.—Values of one of the Short Scale Divisions.

First Series. 1 ^h .					Second Series. 3 ^h .				
Scale Division.	Vernier B.	Scale Division.	Vernier B.	Value of one Division.	Scale Division.	Vernier B.	Scale Division.	Vernier B.	Value of one Division.
40	55 26 56.5	90	54 49 27.5	0.74967	130	54 11 28.0	180	53 34 2.5	0.74850
50	55 19 26.0	100	54 41 57.5	74950	140	54 3 58.5	190	53 26 31.0	74902
60	55 11 56.0	110	54 34 27.5	74950	150	53 56 30.0	200	53 19 2.5	74902
70	55 4 3.0	120	54 26 52.0	75267	160	53 48 55.0	210	53 11 35.0	74667
80	54 56 55.5	130	54 19 23.5	75050	170	53 41 32.5	220	53 4 3.5	74967

1st series ; one division of the short scale of 300 divisions = 0.7504

2d series ; = 0.7486

The adopted value of one division of the short scale = 0.7500.

* The differences in the partial results, it is believed, are not due to errors of graduation of the scale, as different comparisons give different results. If greater accuracy could be gained in the readings of the horizontal circle, it is obvious that the mean of the angle subtended by one or two hundred scale divisions ought not to be taken as the value of the angle subtended by one scale division.

9. From the adopted values of the long and short scale divisions, the co-efficient for reducing divisions of the short scale to the same value as the divisions of the long scale, is $\frac{7500}{6725} = 1.115$; the reciprocal = 0.897.

10. Determination of the scale readings at the magnetic axis of the declinometer magnet.

For this purpose, the scale reading is first observed with the magnet in its usual position (direct), and next with the magnet inverted, the stirrup being made with prolonged sides to admit of this inversion. Simultaneous observations of the unifilar magnetometer are made in order to eliminate the changes of declination during the intervals. When these eliminations are performed, the mean of the reading with the magnet, direct and inverted, is the reading at the magnetic axis. *Increasing* readings (the magnet being direct), indicate *decreasing* westerly declination.

1. *Observations with the Long Scale.*

May 5. 1843.	1 inversal (the copper ring used)	gives the zero reading,	256.87
May 6. 1843.	3		257.30
July 19. 1843.	6		256.88
Oct. 16. 1844.	In the following series the copper ring was not used.		

TABLE 3.—Long Scale Reading at the Magnetic Axis of the Declination Magnet.

Position of Magnet.	Declinometer Reading.	Unifilar Reading.	Unifilar, <i>minus</i> 129 Sc. Div., reduced to the Declinometer = <i>u</i> .	Declinometer Reading.		Mean of each two direct, and of each two inverted.	Reading for Magnetic Axis.
				Direct <i>minus u</i> .	Inverted <i>plus u</i> .		
	Sc. Div.	Sc. Div.	Sc. Div.	Sc. Div.	Sc. Div.	Sc. Div.	Sc. Div.
Direct	269.67	129.75	+ 0.84	268.83			
Inverted	245.10	129.58	0.65		245.75	268.65	257.20
Direct	268.89	129.38	0.43	268.46		245.69	257.07
Inverted	245.30	129.30	0.33		245.63	268.53	257.08
Direct	269.67	129.95	1.06	268.61		245.62	257.11
Inverted	243.92	130.52	1.69		245.61	268.69	257.15
Direct	271.33	131.29	2.55	268.78		245.57	257.17
Inverted	242.19	132.00	3.34		245.53	268.72	257.12
Direct	272.22	132.19	3.56	268.66		245.66	257.16
Inverted	241.59	132.77	4.20		245.79	268.70	257.24
Direct	273.31	133.10	4.57	268.74			

The mean reading of the long scale for the magnetic axis = 257.14.

This determination has been adopted, as the varying position of the copper ring in the other series was apt to render the results uncertain. (See No. 12.)

The zero used for the observations 1841 and 1842 = 255.2 (*Introduction*, 1841-2, Table 4), was used till Jan. 13. 1843, after which the previous determination was taken, as it was conceived that some change might have occurred at that date in a slight adjustment of the appendages of the magnet, made for the purpose of balancing it.

2. Observations with the Short Scale.

TABLE 4.—Short Scale Reading at the Magnetic Axis of the Declination Magnet.

Date.	Position of Magnet.	Declino- meter Reading.	Unifilar Reading.	Unifilar, <i>minus</i> 250 Sc. Div., reduced to the Declinometer = <i>u</i> .	Declinometer Reading.		Mean of two direct or inverted.	Reading for Magnetic Axis.
					Direct <i>minus u</i> .	Inverted <i>plus u</i> .		
d. h.		Sc. Div.	Sc. Div.	Sc. Div.	Sc. Div.	Sc. Div.	Sc. Div.	Sc. Div.
July 31	3 Direct	148.91	257.15	+ 6.42	142.49			148.53
	Inverted	147.16	258.27	7.42		154.58		
Aug. 2	0 Direct	149.24	260.15	9.11	140.13		139.10	146.58
	Inverted	146.37	259.70	8.70		154.07		
	Direct	144.51	257.18	6.45	138.06			
Aug. 2	3 Inverted	148.90	259.41	8.45		157.35	147.02	
	Direct	145.75	260.10	9.06	136.69			
Aug. 3	0 Direct	146.06	259.60	8.61	137.45		137.62	146.63
	Inverted	150.71	255.50	4.94		155.65		
	Direct	142.04	254.74	4.25	137.79			
Aug. 3	4 Direct	142.66	254.28	3.84	138.82		139.27	146.83
	Inverted	149.50	255.46	4.90		154.40		
	Direct	145.78	256.74	6.05	139.73			
Aug. 3	7 Direct	157.15	267.80	15.97	141.18		141.24	147.34
	Inverted	136.95	268.38	16.49		153.44		
	Direct	157.38	267.92	16.07	141.31			
	Inverted	137.51	266.81	15.08		152.59		
	Direct	155.88	266.93	15.19	140.69			

The mean reading of the short scale for the magnetic axis = 147.11.

Corrections to be applied to the Scale Readings at the Magnetic Axis of the Declination Magnets, in order to obtain the zeros of the scales.

11. Correction for the effects of the bifilar and balance magnets on the readings of the declination magnet.

The effect of the bifilar magnet (by Table 5. of the Introduction to the Observations for 1841 and 1842, north end west) = - 0.64 long scale divisions.

Sept. 4. 1843, and Jan. 25. 1844. The balance magnet was removed for the purpose of determining its temperature co-efficient. Its effect (north end east) was found = + 0.79 and + 0.80 long scale divisions, on the respective occasions.

The adopted effect of both magnets, and, therefore, the correction of the scale reading at the magnetic axis for the zero, = + 0.16 long scale divisions, or + 0.14 short scale divisions.

12. Correction for the effect of the copper ring or damper.

In 1843 many series of observations were made in order to determine this correction; the reading of the declination magnet was observed with the copper ring in its place, and when removed from the box. The results were contradictory, being, for the effect of the copper ring, from - 1.82 to + 1.89 long scale divisions, and led to the belief that the effect was small, if anything: the differences in the results, it was presumed, were due to the currents of air generated in lifting and shutting the box, to the changes of declination occurring at the time, and to the greatly increasing arc of vibration when the ring was removed. In July 1843, after an extra declinometer was obtained (§ 4), the results were equally contradictory, the differences being attributed to aerial currents, as before. The result of the best observations being nearly zero, the ring was therefore allowed to remain.

Oct. 7. 1844. Careful series of observations were made, every precaution was taken, with the aid of the *double* boxes, to prevent internal currents of air, and the position of the ring on the marble slab was marked, so that it occupied exactly the same place after each removal. It is conceived that it was owing to a failure in the latter precaution that many of the irregularities of the previous results were due. In the following series, each of the declinometer and unifilar readings is a mean of two or three series of comparative observations, the series being made at intervals of about ten minutes.

TABLE 5.—Observations to determine the effect of the Copper Ring or Damper on the Long Scale Readings of the Declination Magnet.

Copper Ring on or away.	Declinometer Reading.	Unifilar reading, minus 130 Sc. Div., reduced to Declinometer = <i>u</i> .	Declinometer minus <i>u</i> .	Means of two on, and of two away.	Effect of Copper Ring.
	Sc. Div.	Sc. Div.	Sc. Div.	Sc. Div.	Sc. Div.
On	275.52	9.51	266.01		
Away	274.63	7.38	267.25	265.70	- 1.55
On	271.16	5.76	265.40	267.35	- 1.95
Away	271.63	4.18	267.45	265.74	- 1.71
On	267.45	1.37	266.08	267.50	- 1.42
Away	271.56	4.02	267.54	265.96	- 1.58
On	269.02	3.18	265.84	267.50	- 1.66
Away	270.62	3.16	267.46	265.60	- 1.86
On	269.72	4.36	265.36	267.27	- 1.91
Away	273.38	6.30	267.08	265.23	- 1.85
On	271.67	6.57	265.10		

The mean of the partial results for the position of the ring during these observations = - 1.7 long scale divisions. The position of the ring in this case, how-

ever, differed slightly from that which it was conceived the ring occupied previously; and it should be remarked that when any cause (such as elimination of the torsion of the suspension thread) rendered it necessary to remove the ring, it was replaced, by means of marks on the marble slab, very nearly in the same position. After the above series of observations, the ring was moved till its north end was 5° to the east, and its south end was 5° to the west of its usual position, when the effect of the ring was found = + 4.2 long scale divisions.

Oct. 15. 1844. Observations were made with the ring in its usual position, and in the position occupied during the series of observations in Table 5, when the effect in the latter position, compared with that in the usual position, was found = - 0.8 long scale division, so that the effect of the copper ring in its usual position would = - 0.9 scale division. A single comparison with the ring in its usual position and away, gave the effect = - 1.4.

13. The adopted effect of the copper ring during 1843 = - 1.0 long scale division.

As the effect of the ring varied with its position, if its position remained constant it would also vary with the changing declination. When the westerly declination diminished, the negative effect of the copper ring would be increased, and *vice versa*; but this variation would be inconsiderable for the ordinary diurnal changes.

14. Correction for the effect of the non-parallelism of the plates of glass in the declinometer boxes.

The magnet being caused to rest on wooden blocks, the scale readings were observed with the glass in its usual position, reversed, and away, but no difference in the readings could be detected; the effect is therefore zero.

15. Correction for the torsion force of the suspension thread, and the principal facts relating to the latter.

The errors due to the torsion force of the suspension thread are produced, first, by the magnet moving out of the plane of detorsion; secondly, by the variation of this plane (due generally to the varying humidity of the atmosphere).* The error due to the former, even in the most marked case, is less than the probable error of observations, and it is altogether inappreciable compared with the error due to the second.

If the plane of detorsion be that of the magnetic meridian, and the magnet be deflected through the arc u by turning the arms of the torsion circle w , the torsion is $w - u$, and the ratio

$$\frac{u}{w - u} = \frac{\text{torsion force for an arc} = \text{radius}}{\text{earth's mag. force} \times \text{mag. moment of the bar}} = \frac{H \dagger}{F}$$

* This source of error was removed to a considerable extent in January 1844, by placing a thick cotton cover over the whole declinometer.

† The symbols used in the "Report of the Committee of Physics and Meteorology of the Royal Society," and by Dr H. LLOYD, are generally adopted in this volume.

is the quantity by which the deviations of the magnet from the plane of detorsion should be multiplied, to obtain the decrements due to torsion. If n be the observed deviation, $\left(1 + \frac{H}{F}\right) n =$ the true deviation. Following are the observations for the value of $\frac{H}{F}$; no use has been made of them for this correction.

Jan. 13^d 2^h, 1843. $\text{Arc}^{-1} w = \begin{cases} +90^\circ \\ -90^\circ \end{cases}$; $\text{arc}^{-1} u = \begin{cases} 8'20 \\ 8'44 \end{cases}$; mean value of $\frac{H}{F} = 0.00154$.

Aug. 7^d 2^h, $\text{Arc}^{-1} w = \begin{cases} +90^\circ \\ -90^\circ \end{cases}$; $\text{arc}^{-1} u = \begin{cases} 7'97 \\ 7'90 \end{cases}$; mean value of $\frac{H}{F} = 0.00147$.

16. The second and most important error due to the torsion force is that produced by the varying plane of detorsion. Unless when the period and extent of change is known, it can only be corrected practically. This is done occasionally in the following manner:—The magnet being removed, a brass bar of nearly the same dimensions and weight being suspended, and the box being completely closed, the extremities of the arc of vibration are observed through the glazed lid. The marble slab beneath having radii drawn for every 5° on each side of the magnetic meridian, the position of rest being estimated, its deviation from the magnetic meridian is known, and the arms of the torsion circle are turned an equal amount in the opposite direction. Much care and time were bestowed on these observations, the extremities of at least two vibrations being observed, so that the torsion might be as completely eliminated as possible. Some annoyance was experienced by the breaking of the suspension thread, which was formed of 20 fibres of untwisted silk. The necessity of removing the magnet for the purpose of eliminating the torsion, was, it is believed, occasionally a source of it, owing to the difficulty of holding the thread with a force exactly equal to the weight of the magnet till the suspension of the brass bar, and the consequent liability to strain, or by loosening, to alter the disposition of the fibres; but much graver errors would have been introduced by leaving the magnet wholly untouched.

17. The principal facts relating to the suspension thread.

Jan. 2^d 21^h. 1843. The plane of detorsion was found $+ 26^\circ$ from the magnetic meridian (reckoning deviations to the east of the magnetic north positive). This change, since December 20. 1842, it is probable, was produced in taking out the magnet and inserting the brass bar, as it was found that a fibre of the suspension thread was then broken; another fibre was probably broken on again inserting the magnet, as on

Jan. 6. 1843, the error of the plane of detorsion was found $+ 30^\circ$; the broken fibres were withdrawn on Jan. 13, and the torsion eliminated.

May 26^d 3^h. Two fibres of the suspension thread were found broken; the torsion was eliminated.

June 16^d 2^h. Three fibres of the suspension thread were found broken; all the broken fibres were removed from the thread, and the torsion was eliminated.

June 22^d 9^h 5^m. About the termination of the term observations it was discovered that three fibres of the suspension thread were broken ; when the box covers were removed, the stirrup of the magnet was found resting on the copper ring. The observations for some time before this was noticed were found valueless ; and it is probable that they were affected by a varying torsion force throughout the day.

June 22^d 22^h. While taking out the magnet and suspending the brass bar, the suspension thread broke fibre by fibre. A new suspension thread was prepared a week ago in the following manner :—A quantity of the compound silk fibre, about 23 times the length of the desired suspension thread, was run several times from one extremity to the other, between the thumb and index, until almost all the twist which the fibres receive in reeling was removed ;* the fibre was then wound side by side round two pins, placed at the required distance in such a manner that no twist was introduced in the winding ; a weight was then suspended by the lower extremity of the loop thus formed, so as to allow the fibres to take the same length, the torsion was so small that the weight did not revolve above 180°. After hanging thus for a week, the thread was to-day placed in the declinometer, great care being taken in pegging the extremity, and in winding up to keep the fibres in their respective positions ; this thread was not tied throughout its length, as in the previous case several of the breaks were observed to occur at one of the lower ties.

June 29. It was found that several trials gave different positions for the plane of detorsion.

June 29^d 23^h. The plane of detorsion was found to have varied -74° ; this was eliminated. The brass bar was then lifted two or three times, so as to loosen the fibres, after which the error of the plane of detorsion was found -26° ; this was also eliminated, and the bar again lifted, when another trial gave the error of the plane of detorsion $-20\frac{1}{2}^\circ$. After elimination the magnet was inserted. 30^d 3^h. The magnet being removed, and the brass bar inserted, the error of the plane of detorsion was found $+54\frac{1}{2}^\circ$, which was eliminated. It was quite evident that the fibres took different relative positions too easily, so that, in exchanging the brass bar for the magnet, or *vice versa*, considerable torsion might be introduced. At 30^d 7^h, the thread was removed from the declinometer, and suspended on a pin, with the brass bar attached. When the latter came to rest, the thread was tied firmly (but not too tightly) at half-a-dozen places throughout its length with pieces of *cotton* thread ; the suspension thread was then replaced in the instrument, and, after careful winding up, the torsion was eliminated. This thread, composed of 22 fibres, has answered well, improving as it got older. The greater changes of the plane of detorsion will be found generally connected with some cause stated in the notes to the Daily Observations of Magnetometers.

18. Accidental sources of error.

* The fibre is termed untwisted silk ; it is not, however, free of twist, as a slight examination will shew.

March 29. 1843. A small magnet, intended to be placed in the brass bar to facilitate the determination of the plane of detorsion, but which was never used, was found in the writing-desk; the latter occupied a position to the east of the reading telescope of the declinometer, except on term-days, when, for convenience, it was moved to a position nearly midway between the declination and balance magnetometers. In the usual position of the desk, the greatest effect of the small magnet, on the reading of the declination magnet, might be from $-0\cdot2$ to $+0\cdot2$; and during term-days from $+1\cdot1$ to $-1\cdot1$. It is probable that the magnet remained in the same position in the desk, and, therefore, the effect would be constant for each position of the desk.

The large copper stove, occupying the position S in the plan, was removed early in 1844. Its effect was tried on the balance needle, by approaching and removing it, and was found to be nothing.

19. From Nos. (11) and (13) we find the following corrections to be applied to the scale readings at the magnetic axis of the declination magnet, in order to obtain the readings which shall be used as the zeros of the scales:—

Reading of the long scale at the magnetic axis,	257·14
Correction for the effect of the bifilar and balance magnet (11), +	0·16
Correction for the effect of the copper ring or damper (13), —	1·00
	256·30
Adopted zero for the long scale,	256·30
Reading of the short scale at the magnetic axis,	147·11
Correction for the effect of the bifilar and balance magnet (11), +	0·14
Correction for the effect of the copper ring or damper (13), —	0·90
	146·35
Adopted zero for the short scale,	146·35

20. Time of vibration of the declination magnet with the long scale.

The mean of 4 series of observations, given in the Introduction for 1841–2 (22), gives one vibration in $17^s\cdot84$. The following series were made in 1843:—

	d.	h.		s.
Feb. 28	0.	32	vibrations, the observations made at the extremities of the arcs, give a mean of	17·84
.....	40	middle	17·84
March 1	32	extremities	17·81
.....	32	middle	17·81
April 17	3.	22	17·93

The last series was not considered good; the mean of the first ten vibrations of the series gives $17^s\cdot85$.

21. The observations of the declinometer are made in the following manner:—The points of the scale which coincide with the vertical wire of the reading tele-

scope are noted 18 seconds before the minute of observation, at the minute, and 18 seconds after the minute ; the scale readings at these periods being a , b , and c , the mean is deduced by the formula $\frac{a+2b+c}{4}$.

22. All the observations of declination in this volume are absolute. They are rendered so as follows :—

The middle wire of the theodolite telescope is brought to coincide with the vertical wire of the fixed reading telescope (7) ; the three verniers of the horizontal circle are then read ; the theodolite telescope is turned (on the vertical axis of the circle) until its middle wire coincides with the vertical line on the north meridian mark of Sir THOMAS BRISBANE'S (the western) transit in the Astronomical Observatory, and the verniers are again read.

In order to obtain the reading of the horizontal circle for the astronomical meridian, the theodolite telescope was placed as nearly as possible in the meridian, and being accurately levelled, the time of the sun's transit was observed by the Magnetic Observatory clock. The sun's meridian passage was also observed by Sir THOMAS BRISBANE with his western transit in the Astronomical Observatory, and the clocks in the two observatories being immediately compared, the true time of transit by the clock in the Magnetic Observatory was obtained. The difference, if any, between the true and observed times, was due to error of azimuth ; the latter, being very small, was obtained from the former in multiplying by the factor,

$$\frac{\text{cosine sun's declination}}{\text{cosine sun's altitude}}.$$

23. If A' be the difference of the horizontal circle readings for the fixed telescope and for the north mark, Z be the azimuth of the north mark, and D be the angle at any instant contained by the line of collimation of the reading telescope and the adopted zero scale reading, the true westerly declination at that time will be

$$180^\circ - A' + Z \pm D.$$

The values of $180^\circ - A' = A$, obtained in 1843, are given in the following Table :—

TABLE 6.—Determinations of the Value of Angle A.

Date.	Readings of Horizontal Circle									Angle A.
	For Declination Telescope.				For North Mark.					
	Verniers.			Mean.	Verniers.			Mean.		
	A.	B.	C.		A.	B.	C.			
1843.	' "	' "	' "	° ' "	' "	' "	' "	° ' "	° ' "	
Jan. 18	52 5.0	52 10.0	52 55.0	233 52 23.3	42 52.5	42 17.5	42 32.5	77 42 34.2	23 50 10.9	
Mar. 11	52 10.0	52 12.5	53 0.0	233 52 27.5	42 42.5	42 30.0	42 10.0	77 42 27.5	23 50 0.0	
June 3	52 0.0	51 57.5	52 45.0	233 52 14.2	42 37.5	42 3.5	42 20.0	77 42 20.3	23 50 6.1	
June 3	52 1.2	51 57.5	52 45.0	233 52 14.6	42 32.5	42 0.0	42 15.0	77 42 15.8	23 50 1.2	
June 29	52 2.5	52 2.5	52 50.0	233 52 18.3	42 45.0	42 12.5	42 35.0	77 42 30.8	23 50 12.5	
July 27	51 52.5	51 57.5	52 45.0	233 52 11.7	42 30.0	42 2.5	42 15.0	77 42 15.8	23 50 4.1	
Sept. 23	52 10.0	52 10.0	52 56.0	233 52 25.3	42 57.5	42 20.0	42 40.0	77 42 39.2	23 50 13.9	
Sept. 29	52 40.0	52 45.0	53 33.5	233 52 59.5	43 15.0	42 41.5	43 50.0	77 43 15.5	23 50 16.0	
Nov. 6	53 17.5	52 57.5	53 16.0	53 53 10.3	42 55.0	43 25.0	43 42.5	257 43 20.8	23 50 10.5	

The mean value of angle A = 23° 50' 8".4.

The value of angle Z, by the observations, Table 8, Introduction 1841-2, = 1° 37' 38".8.

Whence $A + Z = 25^\circ 27' 47''.2 = 25^\circ 27'.79$ ($25^\circ 27'.75$ was used), which is the absolute westerly declination corresponding to the long scale reading (as corrected, No. 19.), 256.30, and to the short scale reading (as corrected, No. 19.) 146.35. For other scale readings, differing from these zeros by the angular quantity $+ D$, the declination is obtained as indicated above. Tables have been formed from the above, and the known angular values of the scale divisions (8.), by means of which the scale readings observed are at once converted into the absolute westerly declination.

§ 4. UNIFILAR MAGNETOMETER AND OBSERVATIONS OF THE ABSOLUTE HORIZONTAL INTENSITY OF THE EARTH'S MAGNETISM.

24. In the beginning of April 1843 two small wooden houses were erected about 19 yards to the north of the Magnetic Observatory; the larger of the houses contains the unifilar magnetometer and the dip circle, and the smaller, which is 10 feet to SSE. of the larger, contains a reading telescope for the magnetometer. The instruments were in their positions in June, and the first observation of the absolute horizontal intensity was made in August.

25. The unifilar magnetometer rests on a strongly braced wooden stand, which is fixed by copper battens and plaster of paris to a stone slab, resting on a stone

foundation separated from the floor; the top block of the stand, a solid piece of mahogany, carries a vertical box enclosing the suspension thread and supporting the torsion circle, this box is open on two opposite sides near the stand top; a horizontal box slides on the vertical one, and when close to the stand top the magnet is completely enclosed; an internal box was afterwards added, and all the precautions already indicated (6.) for the declinometer were taken. The magnet used when observations of absolute horizontal intensity were made was that usually in the declinometer, a spare magnet being fitted with a short scale (8.) was substituted for it; the telescope (that intended for a collimator to the bifilar) was placed in the smaller wooden house, on a stand in all respects similar to that for the unifilar: the two houses were connected, during observations, in the line of collimation of the telescope and magnet by a wooden tube blackened within. A beam of straight well seasoned fir, 11 feet long, $3\frac{3}{4}$ inches broad, and $1\frac{3}{4}$ inches thick, was placed on each side (outside) of the larger wooden house, in the line passing through the centre of the suspended magnet, and at right angles to the magnetic meridian; each beam was let into the tops of two strongly braced wooden trestles, 7 feet apart, which rested on wooden posts driven into the ground, and which were fixed to the latter by catch pins, allowing a slight adjustment for the distance of the beams from the magnet; the trestles and beams being removed after each observation. The beams were carefully divided with the aid of a brass standard yard made by Messrs TROUGHTON and SIMMS; the graduations were adjusted to their distance from the suspended magnet in the following manner:—a well seasoned fir rod, shod with brass at one extremity, and terminated at the other by a capstan-headed screw, by which the rod was accurately adjusted to a length of six feet, was passed through holes in the sides of the wooden house and unifilar box; the middle of the rod coinciding with the suspension thread, the catch pins of the trestles were then loosened or forced in till the extremities of the six feet rod coincided accurately with the division 3 feet on each beam. The deflecting magnet was adjusted to the graduations on the beams with the aid of a lens; in 1844 the graduations were marked on brass pin heads placed in the beams. The fixidity of the trestles was verified in general after each observation, and the accuracy of the graduations on the beams was verified usually before each observation.

26. The value of the absolute horizontal intensity is determined from the observations as follows:—if r be the distance at which the centre of the deflecting magnet is placed on the wooden beam (in the direction of the central line of the beams), and u be the corresponding angle through which the suspended magnet is deflected, then

$$\frac{m}{X} = \frac{1}{2} r^3 \tan u \frac{1}{1 + \frac{p'}{r^2} + \frac{q'}{r^4} + \&c.}$$

where m is the magnetic moment of the deflecting bar, X the absolute horizontal

intensity in terms of the units used, and p' and q' quantities depending on the mode of distribution of magnetism in the magnets. The term $\tan u$ is obtained from the formula

$$\tan u = \tan \alpha^* \left\{ \frac{(u_1 + {}_1u - u_0 + {}_0u) - f(d_1 + {}_1d - d_0 + {}_0d)}{4} \right\} \left\{ 1 + \frac{H}{F} \right\} \left[1 + q(t_d - t_v) + k(b_r - 500) \right]$$

where u_1 and ${}_1u$ are the observed mean readings of the unifilar magnetometer, the deflecting bar, with its north pole towards the east, being at the distance r to the east and west respectively of the suspended magnet; similarly, u_0 and ${}_0u$ are the readings when the deflecting bar, at the distance r , has its north pole towards the west; $d_1, {}_1d$, &c. are the simultaneous readings of the declinometer corresponding to $u_1, {}_1u$, &c.; $f=1.115$ is the co-efficient for reducing the scale values of the declinometer to those of the unifilar; α is the angular value of one scale division of the unifilar; $\left(1 + \frac{H}{F}\right) = 1.00212$ is the torsion factor; $q=0.000288$ the temperature co-efficient for the deflecting bar (60.); t_d and t_v its temperature at deflection for the distance r and for vibration, respectively; k the co-efficient for reducing the scale divisions of the bifilar magnetometer to parts of horizontal force; b_r the bifilar magnetometer mean scale reading during deflection at the distance r .

27. The comparative observations for u and d were rendered simultaneous, thus: The times of vibration of the unifilar and declination magnet being nearly the same, the time at which the unifilar magnet attained one extremity of its arc of vibration was instantly indicated by me to Mr WELSH, who could observe my motions through one of the north windows of the Observatory. He immediately commenced counting the beats of the mean time clock, and at the end of the 18th second (the time of one vibration) both observers commenced making readings of the magnetometers; those by Mr WELSH being made at the end of the 18th, 36th, 54th, &c., seconds, and those by myself at the extremities of the arcs of vibration. From 7 to 12 consecutive readings were made thus at every position of the deflecting bar, and from these the mean readings are deduced. In order to render the arcs of vibration of the unifilar as small as possible, the deflecting bar was at first moved gradually up to its nearest distance (5 feet); in placing it at the next distance, it was moved rapidly *nearly* half way, and 18 seconds counted, when it was immediately shifted to the other half. When the farthest distance was attained, it was placed vertically, and after 18 seconds, laid down in the reverse position; it was then moved as before, by half-shifts, to its next position, and so up to the nearest. After comparative readings for that position, the magnet was again placed vertically, and carried to the beam on the opposite side of the suspended magnet; at the end of 36 seconds

* The formula actually used was $\tan \{ \alpha (u_1 + \text{&c.}) \}$, as it was considered more convenient and sufficiently exact for such small deflections, especially when the method of determining α was taken into consideration. (See note to No. 8.)

it was laid down at the same distance, and with the north pole in the same direction as before. In general, the vibrations were small, seldom above 10'; when larger, it was checked by slightly approaching or removing the deflecting bar at proper times, with reference to the directions in which the suspended magnet was moving. Mr WELSH observed the bifilar magnetometer before and after each comparison, and I observed the temperature of the deflecting bar after each comparison by means of a thermometer lying beside it.*

28. After the deflection observations, the deflecting bar was vibrated in the declinometer box; it was suspended in a stirrup of silk of the same kind as that of the suspension thread, a small slip of paper was gummed to the extremity next the telescope, and the transits of the slip were observed.

The following equation is then obtained:—

$$m X = \frac{K \pi^2}{T^2} \left\{ 1 + k (b - 500) \right\}$$

where K is the moment of inertia of the magnet $= \frac{a^2 + b^2}{12} M$, a being the length of the magnet = 1.25 feet, b the breadth = 0.0719 feet, M the mass = 6216.7 grains, π , the ratio of the circumference to the diameter = 3.1416, T , the true time of observation $= T' \left(1 + \frac{H}{2F} - \frac{\alpha \alpha'}{16} \right)$; T' being the observed time of one vibration, $\frac{H}{F}$ as already defined (15.) and determined from the value 0.001465 for the declination magnet thus; the moments of the declination magnet and deflecting bar are as $\frac{1.000}{0.942}$, the value of $\frac{H}{F}$ for the deflecting bar is therefore $= \frac{0.001465}{0.942} = 0.0015562$, α and α' are the semiarcs of vibration at the commencement and termination of the observations of vibration. The factor $\{1 + k(b - 500)\}$ is the reduction of the value of X to the bifilar reading 500, b being the mean bifilar reading during vibrations.

The temperature of the bar during vibrations is observed, and the value of m is reduced to this temperature in the formula for deflections.

29. Observations of deflection were made on August 12 and 21, November 8 and 14, and on December 18. The observations on, August 21 and November 8 were reduced by the method of least squares, the equations of condition having the form

$$-1 + \frac{p}{r^2} + \frac{q}{r^4} + \frac{1}{\frac{1}{2} r^3 \tan u} \cdot \frac{m}{X} = 0$$

* It was soon found that good observations could only be obtained on cloudy days, as the sun heated the building on cloudless days to such an extent as to produce internal aërial currents. On account of the manipulations with the deflecting bar being performed outside, rainy days would not do, and it was found desirable that the days should be calm; independently, then, of the necessity for a magnetic calm, there was requisite for a good observation a day cloudy, dry, and calm.

The following Table contains the results of the equations for the different values of r .

$$\text{Aug. 21, } \frac{m}{X} = 2.88977; p = -0.1325; q = -1.0574.$$

$$\text{Nov. 8, } \frac{m}{X} = 2.90250; p = -0.1013; q = -2.8539.$$

TABLE 7.—Results of the Equations of Condition.

r .	August 21.	November 8.
	Results.	Results.
Feet.		
5.00	+ 0.000002	- 0.000051
5.25		+ 0.000359
5.50	+ 0.000163	- 0.000275
6.00	- 0.000786	- 0.000495
6.50	- 0.000610	+ 0.000144
7.00	- 0.000091	+ 0.001098
7.50	- 0.000556	- 0.000788
8.00	+ 0.002780	
8.50	+ 0.000631	
9.00	- 0.001908	
9.50	- 0.000333	

30. The mean of the above values of p and q were applied to the equations for August 12, November 14, and December 18;* on the first of these days deflections were made at three distances, and on the other two at four distances. The results of the equations are as follow :

TABLE 8.—Results of the Equations for August 12, November 14, and December 18.

August 12.		November 14.		December 18.	
r .	$\frac{m}{X}$	r .	$\frac{m}{X}$	r .	$\frac{m}{X}$
Feet.		Feet.		Feet.	
5.000	2.8878	5.125	2.8701	5.000	2.8890
5.500	2.8906	5.250	2.8662	5.250	2.8738
6.500	2.9005	6.750	2.8677	6.625	2.8676
		7.000	2.8688	7.000	2.8745
Mean	2.8928	Mean	2.8682	Mean	2.8762

* This method was recommended by Mr AIRY (Proceedings of the Committee of Physics of the Royal Society, No. 1.) The results for Nov. 14 and Dec. 18, by the approximate formula (31.), shew to some extent how far it may be depended on. It should be remembered that the magnet was subjected to temperature experiments between Nov. 8th and 14th.

31. The observations, November 14 and December 18, have also been computed by the approximate formula in which q' is neglected and p' eliminated, namely,

$$\frac{m}{X} = \frac{r_1^5 \tan u_1 - r^5 \tan u}{2(r_1^2 - r^2)}$$

the results are as follow :

$$\left. \begin{array}{l} \text{Nov. 14. } r_1 = 5.125 \text{ feet, } r = 6.750 \text{ feet; } \frac{m}{X} = 2.8762 \\ \phantom{\text{Nov. 14. }} r_1 = 5.250 \text{ feet, } r = 7.000 \text{ feet; } \frac{m}{X} = 2.8691 \end{array} \right\} \text{Mean } \frac{m}{X} = 2.8726$$

$$\left. \begin{array}{l} \text{Dec. 18. } r_1 = 5.000 \text{ feet, } r = 6.625 \text{ feet; } \frac{m}{X} = 2.8444 \\ \phantom{\text{Dec. 18. }} r_1 = 5.250 \text{ feet, } r = 7.000 \text{ feet; } \frac{m}{X} = 2.8795 \end{array} \right\} \text{Mean } \frac{m}{X} = 2.8619$$

32. The following Table contains the values of $\frac{m}{X}$, of $m X$ obtained by the formula, No. 28, from the Observations, pages 83 and 84, and the consequent values of m and X , together with the weight of the final results deduced from the formula

$$\text{Weight} = \frac{\text{Number of partial results}}{\text{Mean of the squares of the partial results } \textit{minus} \text{ the square of the mean}}$$

TABLE 9.—Results of the observations for the Absolute Horizontal Intensity, reduced to the Bifilar Magnetometer reading 500.

Date.	Number of Results.	Temperature of Deflecting Magnet.	$\frac{m}{X}$	$m X$.	m .	X .	Weight.
		°					
Aug. 12	3	69.6	2.8928	33.2505	9.8075	3.3903	102
Aug. 21	10	61.1	2.8898	33.4536	9.8322	3.4024	7599
Nov. 8	7	43.3	2.9025	33.4698	9.8563	3.3958	21308
Nov. 14	4	41.1	2.8682	33.1440	9.7501	3.3993	1947
Dec. 18	4	46.3	2.8762	33.1695	9.7675	3.3959	65
Results from the approximate formula.							
Nov. 14	2	41.1	2.8726	33.1440	9.7576	3.3967	
Dec. 18	2	46.3	2.8619	33.1695	9.7431	3.4044	

Giving the determinations of X , values corresponding to their weights, the resulting value is

$$X = 3.39762$$

the bifilar magnetometer reading 500 scale divisions.

§ 5. BIFILAR OR HORIZONTAL FORCE MAGNETOMETER.

33. This instrument was made by GRUBB of Dublin, and is similar, in its general construction, to the declinometer. An inner box was applied on September 26, 1843; both boxes were gilt, externally and internally, and their joints covered with velvet. The magnet, whose dimensions are 15 inches, $\frac{7}{8}$ inch and $\frac{1}{4}$ inch, is placed in a stirrup, which carries below it a lens and glass scale connected by a tube; the glass scale has 280 divisions, and the graduation at the 300th division, and increasing readings indicate increasing force; the axle of a grooved wheel fits into the suspension eyes of the stirrup, the whole being borne by a silver wire passing round the grooved wheel, and having its two extremities fixed to a suspension roller; the roller is supported by the torsion circle, which also bears beneath the roller a micrometer-headed screw, right-handed where it meets one wire (or portion of the wire), and left-handed where it meets the other. The screw serves to render the distance of the wires at the top equal to the distance at the grooved wheel. A copper ring encircles the magnet in order to check the vibrations. A thermometer by ROSS, with a bulb 0.5 inch in diameter, is inclosed in a glass tube, and is fitted into the lid of the magnetometer box, leaving the bulb below, and the stem and scale above. This thermometer was intended to give the temperature of the magnet, but it was evident (especially while the box was imperfectly closed) that the temperature of the bar and of the air might differ considerably. In order to avoid this source of error, I had a thermometer made by Messrs ADIE and SON, whose bulb rested in a cup, in a brass bar of the same dimensions as the magnet, and was covered loosely by a small brass cap. The following comparisons were made of the indications of the two thermometers, the box being in its original state, and the rise of the temperature considerable. From these comparisons, the necessity of some method which will give the temperature of the bar is at once obvious. As the thermometer by ADIE is only partially in contact with the metal, it may be considered more as an indication of the temperature of the surface than of the interior of the bar.

TABLE 10.—Comparisons of the Thermometers with the Bulb free, and with the Bulb in a brass bar.

Göttingen Mean Time.	Thermometer.		Difference.
	Ross.	Adie.	
1844.			
d. h.	°	°	°
Jan. 2 21	30.9	30.7	0.2
22	31.3	31.0	0.3
23	31.9	31.5	0.4
Jan. 3 0	33.9	33.0	0.9
1	38.9	37.6	1.3
2	42.3	41.0	1.3
3	44.7	43.0	1.7
4	45.6	44.0	1.6
5	45.9	44.5	1.4
6	46.0	44.9	1.1
7	46.1	45.0	1.1
8	45.9	44.9	1.0
11	45.0	44.3	0.7

34. In the adjustment of the instrument, the magnet is forced to a position at right angles to the magnetic meridian, by turning the arms of the torsion circle. As, in forcing the magnet from the meridian, the upper extremities of the wire will move through a greater angle than the lower extremities, the wires will be no longer vertical, and the magnet and appendages will be raised; the forces producing equilibrium will, therefore, be the weight suspended endeavouring to attain the lowest point, and the horizontal component of the earth's magnetic intensity acting on the free magnetism of the bar.

35. If v be the excess of the angular motion of the arms of the torsion circle, or upper extremities of the wire, over u , that of the lower extremity or magnetic bar in moving the latter from the meridian, the equation of equilibrium will be

$$m X \sin u = W \frac{a^2}{l} \sin v.$$

m , X , W , a , and l being respectively the magnetic moment of the bar, the horizontal component of the earth's magnetic force, the weight suspended, the interval, and the length of the wires. The differential of this equation ($u=90^\circ$) divided by it, gives

$$\frac{\Delta X}{X} = n a \cot v + t(Q + 2e - e')$$

n being the number of scale divisions from the zero, or scale reading when $u=90^\circ$, a the arc value in parts of radius of one scale division, t the number of degrees Fahrenheit which the temperature of the magnet is above the adopted zero, Q the

coefficient of the temperature correction for the varying magnetic moment of the bar or the value of $\frac{\Delta m}{m}$ for 1° Fahr., e and e' the coefficients of expansion for the brass of the grooved wheel and silver of the wires.

36. The observations in this volume are given in scale divisions, and are corrected by the coefficient $\frac{q}{a \cot v} = \frac{q}{k}$, q being the total temperature coefficient; the abstracts are then obtained from the formula $\frac{\Delta X}{X} = n a \cot v$ where n is the number of scale divisions corrected for temperature as above.

37. The following are the adjustments and values of the constants.

The angular value of one scale division of the bifilar magnetometer = $1'1223$ (See Table 10, Introduction, 1841-2); increasing readings indicate increasing force. The value of q , the *total* coefficient of the temperature correction, = 0.000247 (71.)

38. It having been suspected that the zero of the scale (the scale reading when $u=90^\circ$) had altered in some way since last adjustment on Oct. 20. 1841 (Introduction, 1841-2, p. xxviii.), the following observations were made

April 27^a 2^h 39^m. Bifilar scale reading 196.9. 2^h 44^m. Bifilar scale reading 196.6; the magnet was then removed carefully, and the equivalent brass weight substituted. The torsion circle was then turned from the reading vernier A $289^\circ 10'$ to A $358^\circ 16'$, or through $69^\circ 6'$, the previous value of v (Introduction, 1841-2, p. xxviii.), when the scale should have read 150, instead of which it read 212.2. As it seemed possible that this difference might be due to pressure exerted on the wires in withdrawing the magnet and substituting the weight, the magnet was again inserted in the stirrup, the weight being removed, and the torsion circle turned till it read A $289^\circ 10'$, when the scale read 297. It was therefore evident that the previous difference might be due in some way to the manipulation it was necessary, however, to go through the adjustment anew.

After several trials the scale reading was found to read the same whether the brass weight or magnet was suspended, when the torsion circle read A $87^\circ 30'$. The weight being suspended, the torsion circle was turned 90° , when it read A $357^\circ 30'$. The collimator was then turned by its independent motion till the scale read 200. The magnet being again suspended, the scale reading was found 200 when the torsion circle was turned $69^\circ 45'$, it then read A $287^\circ 45'$.

April 28^d 0^h 20^m. As the zero of the scale, 200, was taken too high, the adjustment was again performed.

Bifilar scale reading 200. The magnet being withdrawn, the brass weight suspended, and the arms of the torsion circle turned from A $287^\circ 45'$ to A $357^\circ 30'$, the scale reading was found 199, so that the wires had not been affected in the previous adjustment. The collimator was then turned till the scale read 148, this being the mean of several readings; the magnet was again suspended, and the torsion circle

turned through $69^{\circ} 44'$, reading A $287^{\circ} 44'$, the scale reading being 148. The westerly declination during adjustment was $25^{\circ} 28'$.

November 8^d 21^h 20^m. The bifilar magnet was removed in order to determine its temperature correction; the brass weight being substituted, the arms of the torsion circle were turned from A $287^{\circ} 44'$ to A $357^{\circ} 30'$, when the collimator scale read 157.5, or 9.5 scale divisions greater than on April 28, the westerly declination being $25^{\circ} 20'$. As it is necessary to determine the changes of horizontal force during the observations for the temperature correction, the magnet used for deflections in observations of absolute horizontal intensity was substituted. The moment of this bar was found too great for grooved wheel No. 8, previously in use (Introduction, 1841-2. 30.), wheel No. 9 was substituted, whose diameter = 0.459 inch; as the diameter of wheel No. 8 = 0.409 inch, and the value of one division of the micrometer-headed screw = 0.0005194 inch, the wires were rendered parallel by turning the micrometer head through 96 divisions.

The brass weight being suspended, the scale reading was	128.5
The magnet	126.0

The weight being suspended, the arms of the torsion circle were turned through 90° , when it read, vernier A $178^{\circ} 0'$, B $358^{\circ} 0'$; the collimator was then turned by its independent motion till the scale reading was 143; the magnet was suspended, and the scale reading was found 142 when the arms of the torsion circle were turned through $55^{\circ} 17'5$, the circle reading A $122^{\circ} 41'5$, B $302^{\circ} 43'$.

November 10^d 6^h. The temperature experiments having been made, the deflecting bar in the bifilar magnetometer was removed, and the arms of the torsion circle were turned from B $302^{\circ} 43'$ to B 358° nearly, when the scale reading was 143, as in the previous adjustment. Wheel No. 9 was removed, and No. 8 substituted, the micrometer head being turned backwards through 96 divisions.

The bifilar magnet being suspended, the scale reading was	93
The brass weight	96

the arms of the torsion circle were turned through 90° , when the reading was B $358^{\circ} 35'$; the collimator was turned by its independent motion till the scale reading was 172.4, the magnet was inserted and the arms of the torsion circle turned through $68^{\circ} 18'$, when the torsion circle reading was B $290^{\circ} 17'$, and the scale reading 173. The bifilar thermometer $42^{\circ}4$, and the absolute westerly declination $25^{\circ} 18'$.

39. The following are the values of v , of $k = a \cot v$, and of $q' = \frac{g}{k}$, with the periods to which they apply in 1843.

*

TABLE 11.—Values of v , k , and q , in 1843.

Periods to which the Values apply.				v .	k .	q' .	
Jan.	d. 1	h. —	April d. 27	h. 4	69 6	0.0001248	Sc. Div. 1.98
April	28	2—	Nov. 8	22	69 46	0.0001205	2.05
Nov.	9	0—	Nov. 10	6	55 18	0.0002263	1.10
Nov.	10	8—	Dec. 31		68 18	0.0001300	1.90

The values of k are given at the foot of each page of the magnetical observations.

40. During considerable disturbances the collimator scale, which contains too small an angle, goes out of the field of the reading telescope, and it has been found necessary to turn the arms of the torsion circle until it again appears ; without this, it has happened that the greater part of a disturbance could not have been observed. As there was some doubt that turning the arms of the torsion circle after adjustment might affect the instrument injuriously, experiments were made in the end of 1842, during periods of slight change, which shewed, after turning the arms of the torsion circle a few degrees in either direction, that on recurring to the original value of v the scale readings were unaltered.

41. In turning the arms of the torsion circle the value of the scale divisions and the unit of force are changed, it is necessary therefore to reduce the observations to a common unit and zero ; let β be the small angle through which the arms of the torsion circle are turned, $v' = v + \beta$, $m X = F$, $W \frac{\alpha^2}{l} = G$, (34.) The equation of equilibrium originally, $u = 90^\circ$, is

$$F = G \sin v, \dots \dots \dots (1.)$$

for the new value of v , $u = 90 + \Delta u = 90 + \Delta v'$ where $\Delta v =$ the angular value of the scale reading at any instant from the zero reading

$$F' = \frac{G \sin (v' + \Delta v')}{\cos \Delta v'} \dots \dots \dots (2.)$$

Subtracting (1.) from (2.), and dividing by (1.),

$$\frac{F' - F}{F} = \frac{\Delta F}{F} = \frac{\sin v' - \sin v}{\sin v} + \frac{\cos v'}{\sin v} \Delta v'$$

If n be the number of scale divisions from the zero or scale reading for $u = 90^\circ$, when $v' = v + \beta$; and N be the number of scale divisions corrected for temperature from the zero corresponding to the same force when $\beta = 0$, then

$$N = \frac{\sin v' - \sin v}{\alpha \cos v} + n \frac{\cos v'}{\cos v} + t q'$$

or adapting the first constant to logarithmic computation

$$N = \frac{2 \sin \frac{\beta}{2}}{a \cos v} \cos \left(v + \frac{\beta}{2} \right) + n \frac{\cos(v + \beta)}{\cos v} + t q'$$

$$= \quad \quad \quad A \quad \quad \quad + n B \quad \quad \quad + t q'$$

β is considered negative when v is diminished, n is negative when the reading is below the zero, and t is the temperature of the magnet *minus* 26° .

42. It was necessary to turn the arms of the torsion circle once only in 1843, namely, on

May 6^d 10^h 45^m, when vernier B was turned from $287^\circ 44'$ to $291^\circ 45'$, whence $\beta = -4^\circ 1'$, $A = 234.7$ scale divisions, $B = 1.19$, v being $= 69^\circ 46'$.

May 6^d 13^h 45^m, the arms of the torsion circle were turned from B $291^\circ 45'$ to B $287^\circ 41'$, as this was $3'$ different from the original reading, 3 scale divisions were subtracted from the abstracts of the observations from April 28^d 2^h till May 6^d 10^h, the two hourly and extra observations are, however, affected to that amount.

43. The effect of the balance needle upon the readings of the bifilar was determined, September 4^d 1843, to be -4.03 scale divisions; no correction has been applied; the effect of the declination magnet is zero, and the effect of the copper ring or damper has not been determined, but it is supposed to be small.

44. Time of vibration of the bifilar magnet.

Feb.	22.	Mean of 38 vibrations, 1 vibration =	26.18 ^{s.}
March	1.	Mean of 28 vibrations, 1 vibration =	26.25
June	1.	Mean of 27 vibrations, 1 vibration =	27.08
Oct.	25.	Mean of 8 vibrations, 1 vibration =	26.99
Oct.	25.	Another series,	27.03

45. The natural arc of vibration is generally very small, and when considerable the time of vibration is found different from that determined by artificial vibrations (Intro. 1841-2, p. xxix), namely, about 25 seconds, which has been used in the observations. The observations are made as follows:—the point of the scale coinciding with the vertical wire of the fixed telescope is estimated to a tenth of a division at 25^s before the minute of observation, at the minute, and 25^s after it; the mean reading is deduced from the three readings by the formula $\frac{a + 2b + c}{4}$, a , b , and c being the three readings. The mean thus obtained is corrected to the temperature of 26° Fahr., this being below the lowest temperature which occurred within the Observatory in 1843; a constant quantity of 300.0 has been added to all the corrected means. Tables were formed giving the temperature correction for every tenth of a degree above 26° from the formula $(t - 26) q' + 300.0$.

46. The temperature of the magnet was obtained till November 27^d 18^h from the thermometer by Ross, after that time from the thermometer by Messrs ADIE

and SON resting on a brass bar. From September 26^d till November 27^d the temperature of the magnet was probably worse determined than at any other time, as the bulb of the thermometer by ROSS was outside of the *inner* box, while the magnet was within it. December 14^d 1^h, the inner box was removed in order to compare the indications of the thermometers of ROSS and ADIE; it was not replaced till January 10^d 3^h 1844.

§ 6. BALANCE OR VERTICAL FORCE MAGNETOMETER.

47. The balance magnetometer was made by ROBINSON of London. It is composed of a needle 12 inches long, and about $\frac{3}{4}$ inch broad, with knife-edged axle resting on agate planes; at the extremities of the needle are brass rings, each carrying a cross of spider threads. The needle is placed horizontally at right angles to the magnetic meridian; it is accurately adjusted by means of two fine brass screws; one towards one extremity, working horizontally, balances the needle; the other, working vertically near the other extremity, regulates its sensibility. The apparatus is covered by a rectangular box, having glazed openings on two sides opposite the spider's crosses; those on one side allowing light to be thrown on the crosses from two small mirrors; those on the other for viewing them and determining their position, which is done accurately by means of microscopes carrying micrometers. A thermometer within the box gives the temperature of the needle.

48. If m be the moment of free magnetism of the needle, Y the vertical component of the earth's magnetic force, W the weight of the needle, g the distance from the centre of motion to the centre of gravity, ϵ the angle contained by the line joining these two centres and the magnetic axis of the needle, the latter being horizontal, the equation of equilibrium is

$$m Y = W g \cos \epsilon$$

differentiating this equation, dividing by it, and having regard to the sign of $\Delta \epsilon$, we have

$$\frac{\Delta Y}{Y} = \tan \epsilon \Delta \epsilon - \frac{\Delta m}{m}$$

the varying angle which the magnetic axis makes with the horizontal, $\Delta \epsilon$, is obtained from the micrometer observations. See the section on the temperature corrections for $\frac{\Delta m}{m}$.

49. It is conceived that ϵ cannot be determined with accuracy by the method of inversion, owing to mechanical difficulties in the formation of the axle, but Dr LLOYD has shewn* that if the needle be disturbed through a small angle η , the moment of the moving force brought into play by the disturbance is equal and opposite

* Account of the Magnetical Observatory of Dublin, p. 38.

to the change of the vertical component of the magnetic force, which would produce a disturbance = η , and hence he shews that the value of the constant $\tan \epsilon$ will be given by the formula

$$\frac{T'^2}{T^2} = \frac{\tan \epsilon Y}{X} = \tan \epsilon \cot \theta$$

Where θ is the magnetic dip, T' and T the times of one vibration of the needle, the former in a horizontal plane, the latter in a vertical plane.

50. This method has been found to fail in practice; the determination of the time of vibration in a vertical plane has been proved to be a matter of much difficulty, if at all possible, mixed up, as it is, with several sources of error, which are not easily accounted for or eliminated.* It has been shewn with respect to the time of vibration in a vertical plane,

* The following statical method might be substituted for that of Dr LLOYD:—Let η be the small angle which the magnetic axis of the balance needle makes with the horizontal, then the equation of equilibrium is (48)

$$m Y \cos \eta = W g \cos (\epsilon + \eta) \quad (1.)$$

if a magnet, whose moment is M , be placed vertically, with its centre at a distance r from the centre of the balance needle, and in the continuation of the magnetic axis of the balance needle when horizontal, the needle will then make an angle δ with the horizontal, and the equation of equilibrium will be

$$m Y' \cos \delta = W g \cos (\epsilon + \delta) \quad (2.)$$

where

$$Y' = Y + \frac{c M}{r^3} \quad (3.)$$

From equations (1), (2), and (3),

$$\frac{c M}{r^3 Y} = \frac{\tan \delta - \tan \eta}{\cot \epsilon - \tan \eta} \quad (4.)$$

Now, if X be the horizontal intensity of the earth's magnetism, and θ be the magnetic dip,

$$Y = X \tan \theta; \quad (5.)$$

and if the deflecting magnet be placed in the line at right angles to the magnetic meridian passing through the centre of a freely suspended magnet, and u be the angle of deflection when the centres of the magnets are at the distance r_1 , then (No. 26.)

$$\frac{c M}{r^3 X} = \frac{1}{2} \frac{r_1^3}{r^3} \tan u \quad (6.)$$

By equations (4), (5), and (6),

$$\tan \epsilon = \frac{\frac{r_1^3}{r^3} \tan u}{2 \tan \theta (\tan \delta - \tan \eta) - \tan u \tan \eta} = \frac{\frac{r_1^3}{r^3} \tan u}{2 \tan \theta \tan (\delta - \eta)}, \text{ approximately;}$$

and if $\eta = 0$, or be very small, as it is in general, when the needle may be considered horizontal, then

$$\tan \epsilon = \frac{r_1^3 \tan u}{2 r^3 \tan \theta \tan \delta} \quad (7.)$$

If the deflecting magnet be placed at right angles to the suspended magnet (as in Dr LAMONT'S method), then $\sin u$ must be substituted for $\tan u$.

The

1st, That it is found increased after the needle has been vibrated by any means through a large arc (2° or 3°).

2d, That it depends to a considerable extent, much more than theory will account for, on the arc of vibration.

3d, That it is greater for the same arc, if it be deduced from a series commencing with a large arc, than if it be deduced from a series commencing with a small arc.

4th, That it depends on the temperature of the needle.

5th, That it does not vary appreciably with the changes of position of the needle, unless as co-existent (4th) with the changes in the position produced by temperature.*

It does not seem likely that the source of error indicated in the 4th conclusion can be eliminated; any zero of temperature to which the times of vibration might be reduced would be altogether arbitrary. I have also found, since the above results were obtained,

6th, That the effect of one degree Fahrenheit on the time of vibration of the needle is variable, being sometimes as little as $0^s.05$, at other times as much as $0^s.10$.

51. The following method of determining the value of $\tan \epsilon$ has been adopted for the reductions in the abstracts:—if q be the temperature co-efficient, or the value of $\frac{\Delta m}{m}$ for 1° Fahr., $k = \alpha \tan \epsilon$, where α = the arc value of one division of the micrometer head in parts of radius (52.), if it be assumed that the value of $\frac{q}{k}$ found, § 7, is dependent solely on the varying magnetism of the needle, or that the cause by which the time of vibration is affected has no effect on the position of the needle, assuming also that the value of q , determined by the usual method of deflections, is accurate, then by the latter (Introduction, 1841-2, p. xlv),

$$q = 0.000073,$$

by the former (66.)

$$\frac{q}{k} = 7.90,$$

whence $k = \frac{0.000073}{7.90} = 0.0000092$; 0.000009 has been adopted.

The mean value of the angle δ should be determined by placing the deflecting bar at the distance r on opposite sides of the balance needle, and if the needle be nearly horizontal, the deflecting bar should be inverted in each position.

This method has been tried since the previous portion of this note was written, and the mean of two results from deflections within the usual range of the instrument, which differ 0.0000003 , gives

$$k = 0.0000087,$$

very nearly the value obtained No. 51, and adopted in the results; larger deflections seem to give about 0.000008 , but they have not yet been completely reduced. The accuracy of this method seems to depend almost wholly on the determination of δ , and it seems possible to obtain this certainly within $2'$, or that the error of k may not be above 0.0000002 .

* Transactions of the Royal Society of Edinburgh, vol. xvi, p. 67.

Values of the constants and adjustments.

52. Value of one division of the micrometer head in angular measure.

The micrometer heads have 50 divisions numbered at the tens 1, 2, 3, 4, 5, a brass needle with scales graduated to 10', at an equal distance from the centre as the spider crosses in the magnet, was placed on the agate planes, and the moveable wires of the micrometer brought to coincide with the graduated lines of the scale, the micrometer heads being read at each coincidence.

		Left Mic.	Right Mic.
June 21. 1841	(Table 13, Introduction, 1841-2), one division =	0'1004	0'1003
Aug. 30. 1841 =	0'1002	0'0996
Sept. 4. 1843	Observations gave	= 0'1012	
Nov. 13. 1843 =	0'1013	0'0999

Adopted mean value of one division, 0'1003, whence

$$\alpha = 0.00002918, \epsilon = 17^\circ 34', k = 0.000009$$

this value of k has been used in the abstracts.

53. Time of vibration in the horizontal plane.

The adopted mean of all the observations, Table 15, Introduction, 1841-2, is 12^s.0.

54. Time of vibration in the vertical plane.

The needle being in its usual position on the agate planes, the moveable wire of the left micrometer is made to bisect the spider cross ; the needle is then vibrated, by means of a small piece of iron or steel, through an angle varying from 15' to 5', and the periods of the cross passing the wire are estimated. When large arcs of vibration have been taken, the time of vibration is deduced from the last observations of the series, for the reasons stated, No. 50, 2d. The 4th conclusion given, No. 50, cannot be deduced from the observations for 1843, probably because constant arcs of vibration were not used, and the errors indicated 1st, 2d, and 3d, being included in the results. The arc of vibration was estimated till October 18, after which the arc at commencing was measured by moving the wire of the right micrometer on the cross at the extremity of its arc of vibration ; the arc of vibration at the end is generally about 1', being the smallest possible at which the passage of the cross can be estimated with any nicety. The following is a specimen of the observations, and of the method in which the results in the following Table are obtained :—

TABLE 12.—Observations for the Time of Vibration of the Balance Needle in a Vertical Plane, November 24^a 0^h, 1843.

Time of passing the fixed wire.				Time of 10 Vibrations.	
Cross rising.		Cross falling.		Cross rising.	Cross falling.
m.	s.	m.	s.	s.	s.
6	33.6	6	44.1		
	54.8	7	5.4		
7	15.9		26.7		
8	19.0	8	30.0	105.4	105.9
	40.0		51.3	105.2	105.9
9	1.0	9	12.0	105.1	105.3

Time of one vibration = 10^s.55.

TABLE 13.—Values of T, the Time of Vibration of the Balance Needle in a Vertical Plane.

Göttingen Mean Time.		Arc at commencement.	Number of vibrations.	Time of one vibration.	Temperature of Needle.	Göttingen Mean Time.		Arc at commencement.	Number of vibrations.	Time of one vibration.	Temperature of Needle.
d.	h.	'		s.	°	d.	h.	'		s.	°
Jan. 14	2	7.5	30	9.94	56.5	June 15	0	7.5	30	9.72	59.5
Jan. 30	2	8.0	20	9.54	58.9	June 20	22	10.0	20	9.80	58.4
Feb. 6	3	15.0	30	9.45	54.5	June 29	3	12.0	20	9.50	55.3
Feb. 10	0	8.0	10	9.40	51.5	July 13	8	8.0	20	9.25	67.8
Feb. 14	0	12.0	28	9.65	48.1	July 21	7	10.0	30	9.14	61.7
Feb. 16	18	5.0	10	10.00*	44.0	July 26	3	12.0	30	9.28	65.0
Feb. 22	1	12.0	30	9.15	54.4	July 28	7	10.0	20	9.36	61.3
Feb. 27	4	12.0	20	9.42	53.0	Aug. 4	23	7.5	30	9.35	60.0
Mar. 10	1	7.0	20	9.50	51.2	Aug. 18	3	7.5	30	9.45	71.2
Mar. 13	2	12.0	30	9.30†	55.0	Aug. 22	22	10.0	30	9.25	54.6
Mar. 21	3	12.0	20	9.43	48.5	Aug. 25	0	10.0	25	10.75‡	60.5
Mar. 28	3	10.0	12	9.45	40.5	Aug. 29	22	14.0	30	9.97	54.5
Apr. 3	3	10.0	30	9.48	54.0	Sept. 6	20	12.0	30	11.25‡	60.7
Apr. 11	22	12.0	30	9.65	35.0	Sept. 13	1	12.0	30	10.75	62.3
Apr. 17	3	7.0	30	9.60	54.5	Sept. 18	2	12.0	30	10.62	65.0
Apr. 23	23	10.0	20	9.78	46.2	Sept. 22	3	8.0	30	10.62	63.7
May 1	6	10.0	30	9.80	57.6	Sept. 27	6	7.0	40	11.17‡	51.9
May 9	6	7.5	30	9.73	54.6	Sept. 29	0	7.0	40	10.95	46.4
May 16	18	7.0	20	9.60	46.2	Oct. 1	20	4.0	10	11.04	56.9
May 24	3	8.0	30	9.70	49.1						
May 31	23	10.0	30	9.75	48.4						
June 8	2	10.0	30	9.55	56.2						

* Feb. 16. This observation is from a *natural* vibration (produced by currents of air in the box?).

† Mar. 13. After this vibration the magnetometer box was lifted for an instant and then replaced.

‡ Aug 23 and 31, and Nov. 12. The balance needle was removed for temperature experiments, and on Sept. 26 the magnetometer box was removed in order to be covered with gilt paper.

TABLE 13—*continued.*

Göttingen Mean Time.		Arc at commencement.	Number of vibrations.	Time of one vibration.	Temperature of Needle.	Göttingen Mean Time.		Arc at commencement.	Number of vibrations.	Time of one vibration.	Temperature of Needle.		
d.	h.	'		s.	°	d.	h.	'		s.	°		
Oct.	9	2	6.0	30	10.50	49.9	Dec.	1	3	3.0	40	10.02	40.7
Oct.	18	3	7.5	30	10.55	43.3	Dec.	1	22	5.0	30	9.70	35.8
Oct.	25	2	2.7	25	10.20	43.2	Dec.	3	22	4.2	40	9.90	47.2
Nov.	2	3	7.0	25	10.30	41.0	Dec.	4	22	5.0	30	10.01	48.2
Nov.	2	22	6.0	30	10.36	38.3	Dec.	6	22	3.5	40	9.74	45.0
Nov.	8	20	4.5	30	10.34	36.2	Dec.	7	22	3.8	40	10.04	46.5
Nov.	12	20	4.5	30	10.40*	41.6	Dec.	8	22	3.2	40	9.97	46.1
							Dec.	10	22	3.6	40	9.90	46.6
Nov.	13	22	3.0	20	11.20	39.5	Dec.	11	22	4.0	30	9.96	47.4
Nov.	14	22	2.0	12	11.25	38.8	Dec.	12	22	3.8	30	9.85	47.3
Nov.	16	22	5.0	20	10.88	42.8	Dec.	13	22	3.7	40	9.78	47.5
Nov.	17	22	3.5	20	10.88	40.6	Dec.	14	22	4.2	15	9.79	49.9
Nov.	19	22	5.0	30	10.64	41.6	Dec.	15	22	4.1	30	9.87	43.0
Nov.	21	0	4.5	30	10.67	42.5	Dec.	17	22	3.7	40	9.69	45.4
Nov.	21	23	4.0	40	10.58	46.0	Dec.	18	22	3.6	40	9.75	44.6
Nov.	23	0	3.3	30	10.47	39.1	Dec.	19	22	4.4	40	9.61	45.2
Nov.	23	23	4.0	30	10.62	35.5	Dec.	22	1	4.2	30	9.99	49.2
Nov.	24	0	4.0	15	10.55	36.0	Dec.	22	22	4.4	15	9.74	49.5
Nov.	26	22	4.0	15	10.06	49.0	Dec.	24	22	3.8	30	9.73	49.5
Nov.	27	3	1.8	30	10.02	50.0	Dec.	25	22	4.0	30	9.72	47.8
Nov.	27	22	3.6	30	10.03	48.5	Dec.	26	22	3.3	30	9.57	46.5
Nov.	28	22	3.8	30	10.02	46.4	Dec.	27	22	3.7	30	9.55	44.4
Nov.	29	22	4.0	30	10.05	40.4	Dec.	28	22	3.9	30	9.47	45.7
Nov.	30	22	4.0	15	10.27	41.5	Dec.	29	22	3.7	40	9.49	46.3

55. The following are the mean values of T , and the consequent values of k , $T' = 12^s.0$, $\theta = 71^\circ 10'$:—

- Jan. —Aug. 23. $T = 9.52$; $k = 0.0000158$, approximately $k = 0.000015$
- Aug. 24—Sept. 1. $T = 10.40$; $k = 0.0000133$, approximately $k = 0.000014$
- Sept. 5—Nov. 13. $T = 10.65$; $k = 0.0000126$, approximately $k = 0.000013$
- Nov. 13—Dec. $T = 10.07$; $k = 0.0000141$, approximately $k = 0.000014$

The approximate values of k are those given at the foot of each page of the Magnetical Observations. It will be observed that all of these values differ very considerably from that obtained, No. 51, which was adopted in the reductions for the Abstracts, after the above values of k were printed in the notes to the Magnetical Observations.

56. Adjustments.

August 23. 1843. The balance needle was removed for the purpose of determining its temperature coefficient; the needle was placed in a small copper trough with a glazed lid, which trough was surrounded by water, contained in a larger trough.

* Aug. 23 and 31, and Nov. 12. See note on preceding page.

Aug. 24. 1843. The temperature experiments were repeated; the brass rings containing the spider crosses were removed, and the needle was immersed in water of different temperatures; at the end of the observations the needle was found considerably tarnished; the stains were partially removed by rubbing with crocus. After the temperature observations the needle was vibrated horizontally, and then adjusted. When the needle was placed on the agate planes it was altogether out of balance, the S. end falling till caught by the Y; the horizontal screw was then turned in till the reading of the micrometer was about 200 *minus*; both micrometers read the same, and the N. end was much better in focus than before.

Sept. 1. 1843. The balance needle was again removed in order to determine the temperature coefficient, the previous observations not being satisfactory.

Sept. 2. Temperature observations continued, the needle being placed in water as before. The stains were partially removed by rubbing with crocus.

Sept. 4. After vibrating the balance needle horizontally, and determining the value of the divisions of the micrometer head, observations were made to verify the horizontality of the fixed wires in the micrometers, when it was found necessary to move the fixed wire of the right micrometer down 8 micrometer divisions.

The micrometer heads were exchanged for convenience of reading, as the readings are almost always negative, or the north pole of the needle is generally above the horizontal.

57. The deviation of the line joining the spider crosses from the magnetic axis of the needle was determined, by repeated reversals, to be + 8 micrometer divisions; merely lifting the needle by the Ys was found to give readings differing sometimes 20, 30, and even 40 divisions. The horizontal screw was moved till a negative reading of about - 130 was obtained; and as it had been previously found that lifting by the Ys altered the reading, the needle was not left till consistent readings were obtained after the different lifts. The following were the readings at each lift after the last movement of the horizontal screw:—

— 120, — 126, — 121, — 120, — 127, — 138, — 134, — 131, — 134, — 136, — 131.

September 26^d 4^h—6^h, 1843. The balance magnetometer box was removed in order to be covered, externally and internally, with gilt paper.

November 13, 1843. The balance needle was again removed for the purpose of determining its temperature coefficient; the brass rings and spider crosses were removed, and the needle immersed in water as before. The needle was adjusted the same day. The value of the micrometer division was also determined, and the deviation of the line joining the spider crosses from the magnetic axis was found - 36 divisions. The needle was left reading about - 60 divisions.

58. Mode of observation and reduction.

The moveable wire of the right micrometer is made to bisect the spider cross 5° before the minute of observation, and that of the left micrometer 5° after the minute

of observation ; the mean of the two readings gives the position of the needle at the minute. The readings increase negatively or positively as the north pole of the needle moves above or below the horizontal wire ; the readings are generally negative. The quantities given in the magnetical observations are obtained thus :—
 n being the observed reading of the needle, t that of the thermometer, $\frac{q}{k} = 7.90$ the temperature coefficient, R the quantity in the Tables,

$$R = 700 + \frac{q}{k} (t - 26^\circ) + n$$

increasing tabular quantities, therefore, indicate increasing vertical force.

§ 7. DETERMINATION OF THE TEMPERATURE COEFFICIENTS OF THE DEFLECTION, BALANCE, AND BIFILAR MAGNETS.

Deflection Magnet.

59. The magnet used for deflections in observations of the absolute horizontal intensity was placed in a copper trough, resting on a beam of the deflection apparatus (25.); the temperature was varied by means of ice and water of different temperatures ; a thermometer lying on the magnet indicated its temperature ; the declination magnet was observed simultaneously with the deflected (or unifilar) magnet ; and the bifilar magnet before and after each change of temperature.

60. If m be the moment of the magnet, X be the horizontal intensity of the earth's magnetism, δ be the westerly declination, u the angle which the deflected magnet makes with the astronomical meridian, then

$$m = X \tan (u - \delta)$$

differentiating, all the quantities being variable, and reducing

$$\frac{\Delta m}{m} = \frac{\Delta u - \Delta \delta}{\frac{1}{2} \sin 2(u - \delta)} + \frac{\Delta X}{X}$$

or if u and u_0 are the unifilar readings, d and d_0 the declinometer readings, b and b_0 the corrected readings of the bifilar magnetometer when the temperatures of the deflecting magnet are t and t_0 ; D is the mean deflection, in this case small ; f the coefficient for reducing the declinometer scale divisions to values of unifilar divisions, k the bifilar coefficient, then since $\frac{\Delta m}{m} = q (t_0 - t)$

$$q = \frac{\overline{u - u_0} - f \overline{d - d_0}}{D (t_0 - t)} + \frac{k (b - b_0)}{(t_0 - t)}$$

The quantities in the last column of the following Table have been obtained from this formula.

TABLE 14.—Observations for the Temperature Coefficient of the Deflection Magnet.

Göttingen Mean Time, 1843.			Tempera- ture of Magnet.	$t_0 - t.$	Reading of Unifilar.	Reading of Declino- meter reduced $= f d.$	$u - u_0$ minus $f(d - d_0).$	Biflar.		Correction for 1° Fahr. $= q.$
								Reading Corrected.	Thermo- meter.	
d.	h.	m.	°	°	Sc. Div.	Sc. Div.	Sc. Div.	Sc. Div.	°	
Nov. 10	23	24	Magnet	away.	264.39	157.26				
	23	53	35.30		10.73	156.65		501.0	42.6	
Nov. 11	0	13	59.95	24.65	12.05	156.17	1.80	501.7	42.7	0.000287
	0	30	76.85	16.90	13.07	155.59	1.60	502.7	42.8	.000369
	0	46	58.95	17.90	11.88	155.63	1.23	503.3	42.9	.000278
	1	6	36.90	22.05	11.88	155.63	1.69	503.3	42.9	.000309
	1	6	36.90	20.20	10.05	155.49	1.48	503.9	43.0	.000289
	1	24	57.10	21.60	11.68	155.64	1.48	504.3	43.2	.000260
	1	42	78.70	22.20	13.16	155.67	1.45	505.6	43.6	.000272
	2	0	56.50	19.90	11.11	155.13	1.51	505.8	43.8	.000265
	2	18	36.60	20.30	10.05	155.36	1.29	506.8	43.9	.000253
	2	38	56.90	25.05	11.50	155.50	1.31	507.4	44.0	.000307
	2	54	81.95	21.05	13.41	155.50	1.91	506.8	44.3	.000233
	3	14	60.90	24.05	12.50	155.80	1.21	507.4	44.6	.000268
	3	32	36.85	30.50	10.78	155.69	1.61	507.7	44.8	.000287
	3	53	67.35	23.40	13.30	156.00	2.21	508.0	44.9	.000324
	4	10	43.95	22.55	11.72	156.33	1.91	507.8	45.0	.000315
	4	28	66.50		13.88	156.70	1.79	508.1	45.0	
	4	45	Magnet	away.	264.35	157.02				

The mean value of $q = 0.0002877.$

Balance Magnet.

61. The value of the coefficient for the balance magnet was obtained by observations, similar to those for the deflecting magnet, on 5 different days; weight was given to the result of each day's observations, depending on the formula, No. 32. The final result was

$$q = 0.000073.*$$

62. The impossibility of determining the value of the micrometer divisions of the balance magnetometer by the usual method has been already pointed out. It is obvious, therefore, that if shut up to this method the temperature corrections cannot be applied even when the observations are left in the state of micrometer divisions. The doubt whether the changes of the magnetic moment of the needle occur as rapidly as those of temperature in all cases, and therefore, whether a coefficient obtained from changes of 30° or 40° in a few minutes (as in the temperature experiments) was likely to be applicable to observations where the changing temperature of the needle was rarely above 1° in the hour, and the fact that other sources of error (perhaps the effect of temperature on the points of support of the

* Tables 19 and 20, Introduction to the Makerstoun Observations, 1841 and 1842.

needle) were altogether omitted,* these induced me to apply a correction obtained by a method which first occurred to me in 1842, for the purpose of avoiding the necessity of removing the needle and breaking up the series of observations. This method has already been described, and the final results have been given in the Transactions of the Royal Society of Edinburgh (Vol. xvi., p. 73); the coefficients obtained by this method were used for correcting the *results* of the observations of 1841 and 1842; † they have also been used in correcting all the observations in this volume. It will be necessary to enter more fully into the investigations here.

63. A series of days being selected during which the readings of the instrument seem regular (rejecting any day of marked disturbance), and in which the changes of temperature from day to day are considerable; the hourly or two hourly readings for the position and temperature of the needle are separately summed; if y_1 be the sum (or mean) of the micrometer readings for the first day in the series, y_2 for the second day, . . . y_n for the n^{th} day; t_1, t_2, \dots, t_n being the corresponding sums (or means) of the thermometer readings, if q' be the temperature coefficient in micrometer divisions, and it be assumed that the vertical force changes gradually throughout the period, α being the sum (or mean) of the daily changes for all the hours summed for values of $y_1, y_2, \&c.$, we shall then have a series of equations like the following, in which it is considered that the temperature of the preceding day is either greater than that of the succeeding in all the series, or that it is less than it:—

$$\left. \begin{aligned} y_1 - y_2 &= -\alpha - (t_1 - t_2) q' & y_p - y_{p+1} &= -\alpha - (t_p - t_{p+1}) q' \\ y_1 - y_3 &= -2\alpha - (t_1 - t_3) q' & y_p - y_{p+2} &= -2\alpha - (t_p - t_{p+2}) q' \\ \vdots & \vdots & \vdots & \vdots \\ y_1 - y_{n+1} &= -n\alpha - (t_1 - t_{n+1}) q' & y_p - y_{p+n+1} &= -n\alpha - (t_p - t_{p+n+1}) q' \end{aligned} \right\} (1.)$$

Summing all those equations in which α has the same coefficient, naming the differences $y_p - y_{p+1}, \Delta y_1; t_p - t_{p+1}, \Delta t_1$, and since if $t_1 > t_2$, then $y_1 < y_2$, we shall have the equations

$$\left. \begin{aligned} \frac{\Sigma \Delta y_1}{\Sigma \Delta t_1} &= q' + \frac{\alpha}{\Delta t_0} \\ \frac{\Sigma \Delta y_2}{\Sigma \Delta t_2} &= q' + \frac{2\alpha}{\Delta t_0} \\ \vdots & \vdots \\ \frac{\Sigma \Delta y_n}{\Sigma \Delta t_n} &= q' + \frac{n\alpha}{\Delta t_0} \end{aligned} \right\} \dots \dots \dots (2.)$$

* It will be evident, that the method of obtaining the value of the unit for the balance magnetometer, described No. 51, supposes no other source of error than that due to the varying time of vibration, or that the causes of error indicated above are of the second order compared with it.

† The temperature coefficient, obtained by the usual method, had been applied, and the observations so corrected had been printed before I had satisfied myself of the preferability of the new coefficient.

where, as it tends to simplify the investigation, and is at the same time sufficiently accurate, Δt_0 is the mean of *all* the values of Δt .

Taking the difference of each of the equations with that of every one after it, series of equations of the following form will be obtained :—

$$\frac{\Sigma \Delta y_p}{\Sigma \Delta t_p} - \frac{\Sigma \Delta y_{p+r}}{\Sigma \Delta t_{p+r}} = - \frac{r a}{\Delta t_0}$$

Summing these series of equations, we obtain the following :—

$$\overline{n-1} \left(\frac{\Sigma \Delta y_1}{\Sigma \Delta t_1} - \frac{\Sigma \Delta y_n}{\Sigma \Delta t_n} \right) + \overline{n-3} \left(\frac{\Sigma \Delta y_2}{\Sigma \Delta t_2} - \frac{\Sigma \Delta y_{n-1}}{\Sigma \Delta t_{n-1}} \right) + \dots = - \frac{n+1 \cdot n \cdot n-1}{6} \cdot \frac{a}{\Delta t_0}$$

Summing equations (1.), we have

$$q' = \frac{1}{n} \cdot \Sigma \frac{\Sigma \Delta (y)}{\Sigma \Delta (t)} - \frac{n+1}{2} \cdot \frac{a}{\Delta t_0}$$

From these two equations q' will be obtained.

63. A period of 52 days, from June 1 till July 22, 1843, was selected as nearly free from disturbances (the 3d and 7th of June only being rejected on this account), and as containing considerable daily changes of temperature ; the sums of the micrometer and thermometer readings for each day were entered in columns titled $\Sigma y, \Sigma t$. each sum, from June 1 till June 26, was then compared with all the sums following, up to the 27th day after. The differences will be found in the following Table in two portions, namely those for which t_p is greater and less than t_{p+r} . The results for a second period, namely, from August 4 till September 18, 1844, are also given.

TABLE 15.—Results of Comparisons at different Intervals.

Period.	Interval between comparisons.	$t_p > t_{p+r}$			$t_p < t_{p+r}$			Mean of the results.		
		No. of comparisons.	$-\Sigma \Delta (y)$	$\Sigma \Delta (t)$	$\frac{-\Sigma \Delta (y)}{\Sigma \Delta (t)}$	No. of comparisons.	$\Sigma \Delta (y)$		$-\Sigma \Delta (t)$	$\frac{\Sigma \Delta (y)}{-\Sigma \Delta (t)}$
June 1—July 22, 1843.	Days.		Mic. Div.	°	Mic. Div.		Mic. Div.	°	Mic. Div.	Mic. Div.
	1	7	1149.8	102.8	11.2	11	2916.7	325.8	8.9	9.5
	2	7	2050.1	224.4	9.1	11	3925.7	477.0	8.2	8.5
	3	9	3171.6	379.2	8.4	9	4341.2	541.4	8.0	8.2
	4	11	3879.0	446.5	8.7	8	4012.0	496.0	8.1	8.4
	5	9	3230.8	386.2	8.4	10	3552.0	421.4	8.4	8.4
	6	7	2967.8	316.5	9.4	11	3035.0	363.6	8.3	8.8
	7	5	2403.0	277.2	8.7	17	5294.4	685.2	7.7	8.0
	8	4	1857.9	210.0	8.8	14	5314.9	694.1	7.7	7.9
	9	6	1391.3	167.9	8.3	12	6094.5	775.1	7.9	7.9
	10	6	782.0	96.1	8.1	11	5281.9	724.6	7.3	7.4
	11	7	1853.8	196.0	9.5	11	5793.0	732.5	7.9	8.2
	12	5	1558.0	210.0	7.4	14	5488.3	669.2	8.2	8.0
13	6	1439.6	192.0	7.5	13	5656.1	734.5	7.7	7.7	

TABLE 15—continued.

Period.	Interval between comparisons.	$t_p > t_{p+r}$				$t_p < t_{p+r}$				Mean of the results.
		No. of comparisons.	$-\Sigma \Delta (y)$	$\Sigma \Delta (t)$	$\frac{-\Sigma \Delta (y)}{\Sigma \Delta (t)}$	No. of comparisons.	$\Sigma \Delta (y)$	$-\Sigma \Delta (t)$	$\frac{\Sigma \Delta (y)}{-\Sigma \Delta (t)}$	
	Days.		Mic. Div.	°	Mic. Div.		Mic. Div.	°	Mic. Div.	Mic. Div.
June 1—July 22, 1843.	14	6	1305.6	161.5	8.1	16	8350.4	1053.9	7.9	7.9
	15	5	867.6	116.0	7.5	13	7452.6	928.7	8.0	8.0
	16	1	249.2	19.0	13.1	17	6895.8	878.3	7.8	8.0
	17	3	122.7	28.2	4.3	15	7329.7	819.5	8.9	8.8
	18	3	523.6	48.8	11.7	16	7453.3	871.6	8.5	8.7
	19	5	722.5	61.5	11.7	14	7758.3	849.7	9.1	9.3
	20	3	684.6	57.5	11.9	15	6731.9	789.2	8.5	8.8
	21	4	371.8	25.0	14.9	18	9824.7	1094.4	9.0	9.1
	22	1	- 60.3	7.5	- 8.0	17	7868.6	901.8	8.7	8.6
	23	1	64.8	26.3	2.5	17	8330.0	929.5	9.0	8.8
	24	1	170.0	33.6	5.1	17	8277.3	939.0	8.8	8.7
	25	3	322.0	88.1	3.7	16	8599.2	961.7	8.9	8.5
	26	5	445.0	125.6	3.5	14	7763.2	861.2	9.0	8.3
	For all the } intervals. }	130	33523.8	4003.4	8.37	357	163340.7	19518.9	8.37	8.37
August 4—September 18, 1844.	1	9	2291.0	281.9	8.1	9	3612.2	359.7	10.0	9.2
	2	11	4152.1	450.0	9.2	6	3270.8	282.9	11.6	10.1
	3	10	4586.5	399.1	11.5	6	2443.8	216.4	11.3	11.4
	4	8	3163.2	269.6	11.7	8	3292.5	281.6	11.7	11.7
	5	7	2738.0	372.4	7.4	9	6118.6	572.1	10.7	9.4
	6	6	2947.5	348.2	8.5	11	7982.3	833.1	9.6	9.2
	7	7	3026.9	342.7	8.8	8	4941.3	609.6	8.1	8.4
	8	7	2422.9	364.7	6.6	10	6033.4	690.0	8.7	8.0
	9	5	2542.5	306.0	8.3	11	6990.6	852.6	8.2	8.2
	10	6	3128.4	394.9	7.9	10	8812.7	979.3	9.0	8.7
	11	7	2382.6	283.3	8.4	9	8056.0	935.0	8.6	8.6
	12	5	1859.8	255.3	7.3	11	7594.6	967.8	7.8	7.7
	13	5	2446.5	310.3	7.9	11	7621.9	1048.7	7.3	7.4
	14	6	2423.3	327.6	7.4	13	8301.4	1106.1	7.5	7.5
	15	4	1029.4	145.1	7.1	12	7282.6	952.0	7.6	7.6
	16	4	992.0	219.3	4.5	12	6617.7	819.2	8.1	7.3
	17	5	1836.3	259.6	7.1	11	6533.0	882.7	7.4	7.3
	18	4	1622.8	194.7	8.3	12	5914.3	841.3	7.0	7.3
	19	3	929.6	110.6	8.4	13	6211.6	912.9	6.8	7.0
20	4	1529.3	174.8	8.7	13	5500.6	783.0	7.0	7.3	
21	3	1348.5	212.7	6.3	12	5666.1	684.3	8.3	7.8	
22	6	2623.6	386.2	6.8	11	6152.6	685.1	9.0	8.2	
	For all the } intervals. }	132*	52022.7	6409.0	8.11	228	134950.6	16295.4	8.28	8.24

From the series, June—July, 1843, in which $t_p < t_{p+r}$, the following result was obtained:—

$$\frac{1}{2} \sum \frac{\Sigma \Delta (y)}{\Sigma \Delta (t)} = 8.338; \frac{a}{\Delta t_0} = 0.0375, \Delta t_0 = - 54.7, a = - 2.05 \text{ or the mean daily}$$

$$\text{change} = \frac{a}{9} = - 0.23; q' = 7.832 \text{ microm. div.}$$

64. The series, June—July, in which $t_p > t_{p+r}$, and the series, August—September, 1844, are either two irregular in the number of days compared, or the

number of days compared are too few to give good results.* It is obvious, however, that if we consider the equation

$$q' = \frac{\sum \Delta y_r}{\sum \Delta t_r} - \frac{r \alpha}{\Delta t_r},$$

that the value of q' deduced from the quantity $\frac{\sum \Delta y_r}{\sum \Delta t_r}$ alone will be too much or too little according as the sign of Δt_r is positive or negative; whence, if a period of moderate length be selected, throughout which the mean daily temperature increases and diminishes considerably, we may neglect the sign of Δt_r and the quantity α , as in the summations the coefficients of the latter will nearly destroy each other. For periods of moderate length, and free from disturbances, it is the fact, as may be seen from the previous Table (with the exception of one day), that the signs of Δy_r and Δt_r are always opposite. The latter method, then, will be found the easiest, and, it is conceived, in general the most accurate. The mean results obtained for the series, June—July, when $t_p >$ and $< t_{p+r}$ are indeed exactly the same, and the partial results seem to indicate that the sign of α is itself so variable as to render its total effect nugatory. The same remark applies to the series August—September 1844.

The following Table contains a series of results obtained according to the latter method. In each series each day is compared with every day following it to the end of the series for the differences Δy and Δt :—

TABLE 16.—Determinations of the Temperature Coefficient for the Balance Magnet from Comparisons of the Daily Observations.

Period.	$\sum \Delta (t)$	$\sum \Delta (y)$	q'	Observed Time of Vibration.	Remarks.
1843.	°	Mic. Div.	Mic. Div.	s.	
Jan. 16—Jan. 21	525.3	4315.3	8.21	9.7	In 1843 there were 9 daily observations, made at two-hourly intervals, from 18 ^h till 10 ^h . Sept. 2, the needle was removed in order to determine its temperature correction by the method of deflections.
Jan. 23—Jan. 28	817.7	5723.5	6.99	9.7	
Jan. 30—Feb. 4	576.0	4151.5	7.21	9.5	
Feb. 6—Feb. 11	609.9	4080.6	6.69	9.4	
June 1—June 30	14320.4	114646.9	8.006	9.7	
Sept. 6—Sept. 16	1083.7	8730.4	8.04	10.8	
1844.					
May 9—May 24	8415.4	66621.7	7.93	8.6	In 1844 there were observations made at every hour of the day. The needle was removed between September 1843 and February 1844 for temperature experiments.
Aug. 3—Sept. 6	21696.9	171460.5	7.902	8.5	
For the series in } 1843, . . . }	17933.0	141648.2	7.898	9.8	
For all, . . . }	48045.3	379730.4	7.903	8.5	

The mean value of q' from the series in 1843 is 7.90, and from the tempera-

* Such as these results are, however, their disagreement with the result obtained by deflection experiments and vibration, is, in each case, even more than that of the adopted result.

ture experiments it is 4.9 micrometer divisions ; the mean of the two series in 1844 gives $q' = 7.91$, while the temperature experiments give it 3.8 microm. div.

65. The following Table contains the results deduced in three cases when respect has been paid to the sign of $t_p - t_{p+r}$; the last column contains the value of q' , obtained by giving equal values to the quantities $\frac{-\sum \Delta (y)}{\sum \Delta (t)}$ and $\frac{\sum \Delta (y)}{-\sum \Delta (t)}$

TABLE 17.—Results of Comparisons, regard being paid to the sign of $t_p - t_{p+r}$.

Period.	$t_p > t_{p+r}$			$t_p < t_{p+r}$			Mean Value of q' .
	$\sum \Delta (t)$	$-\sum \Delta (y)$	$\frac{-\sum \Delta (y)}{\sum \Delta (t)}$	$-\sum \Delta (t)$	$\sum \Delta (y)$	$\frac{\sum \Delta (y)}{-\sum \Delta (t)}$	
1843.	°	Mic. Div.	Mic. Div.	°	Mic. Div.	Mic. Div.	Mic. Div.
June 1—July, 22	4003.4	33523.8	8.37	19518.9	163340.7	8.37	8.37
1844.							
May 9—May 24	5404.3	37559.9	6.95	3011.1	29061.8	9.65	8.30
Aug. 3—Sept. 18	6409.0	52022.7	8.12	16295.4	134950.6	8.28	8.20
For all the periods	15816.7	123106.4	7.783	38825.4	327353.1	8.431	8.107

66. The three final results obtained are $q' = 7.832$, $q' = 7.903$, and $q' = 8.11$; the adopted value of $q' = 7.9$ micrometer divisions.

67. Early in the investigation of this subject it occurred to me that it might not be desirable to eliminate all the effects of change of temperature on the position of the needle, as the actual daily or diurnal variations of the earth's magnetism might depend to some extent on the same cause. The results, obtained in many ways which it is not necessary to repeat wholly here, shewed that, at least for periods of a month, no such connexion exists, or that it is inappreciable. To such an extent had the supposition been refuted, that it was ultimately totally forgotten by me, and, of course, it was also forgotten that others might entertain a similar suspicion; the fact that it has been proposed as an objection to the method will render it desirable that I should adduce distinct evidence of its futility.

68. As it will scarcely be supposed by any one that the earth's magnetism varies immediately with changes of the aerial temperature, the results obtained from the comparison of one day with the next following may be first considered. As far as the results, Table 15, go, the comparisons of one day with the next following give a considerably larger value of q' than that adopted, and, therefore, one differing still more from the value obtained by the usual method; this at least tends to prove that the result adopted is much better than that by the other method. In the following, which also prove the same fact, one-sixth of the comparisons are of the readings on days with those on the second days following, namely, Saturdays with

Mondays; the remaining five-sixths are of the readings on days with those on the days immediately following:—

- 1844. 123 Comparisons, $q' = 8.33$. Approximate value of q' , by temperature experiments and vibrations, = 3.8
- 1845. 126 Comparisons, $q' = 8.87$ = 3.0

69. The most severe method of testing the accuracy of the coefficient thus obtained, is that of artificially heating the Observatory, and of comparing the instrumental readings on days when so heated with those on days when the temperature of the magnet depends on natural causes; * the results of such a series of comparisons are given below. In order to render the series perfectly trustworthy, all selection has been avoided. From January 1 till March 16, 1843, the stove in the Observatory was lighted every day, with the exception of January 23; it was not lighted on any other days of the year, excepting March 22 and 23, October 19, November 25, and December 21; the means of the instrumental readings, corrected for temperature by the adopted coefficient (7.9), on each of these days were compared with the means on the four or five days immediately preceding or succeeding, and the means on March 13, 14, and 15 (the last three days on which the stove was continuously lighted), were compared with the five succeeding days on which the stove was not lighted. The sums of the differences $\Sigma \Delta (t)$ and $\Sigma \Delta (y)$ are given in the following Table, together with the sums of the differences of the external temperatures $\Sigma \Delta (T)$ for the same days:—

TABLE 18.—Results of Comparisons when the differences of the Temperature depend on Artificial Causes.

Day of comparison.	Days compared with	No. of comparisons.	$\Sigma \Delta (T)$	$\Sigma \Delta (t)$	$\Sigma \Delta (y)$	Error of coefficient.	Resulting coefficient.
1843.	1843.		°	°	Mic. Div.	Mic. Div.	Mic. Div.
Jan. 23	Jan. 18—21, 24—28	9	+63.4	139.2	+195.7	+1.41	6.49
Mar. 13	Mar. 16—21,	5	-21.2	35.4	+85.7	+2.42	5.48
Mar. 14	Mar. 16—21,	5	-27.5	31.4	+41.2	+1.31	6.59
Mar. 15	Mar. 16—21,	5	-29.0	31.9	+28.7	+0.90	7.00
Mar. 22	Mar. 16—21, 24—28	9	+79.1	58.8	+6.5	+0.11	7.79
Mar. 23	Mar. 16—21, 24—28	9	+55.7	80.4	-58.3	-0.73	8.63
Oct. 19	Oct. 14—18, 20—25	9	-41.2	108.3	-278.4	-2.58	10.48
Nov. 25	Nov. 21—24, 27—Dec. 1	9	-84.5	113.1	+75.5	+0.67	7.23
Dec. 21	Dec. 16—20, 22—27	9	-49.9	99.0	+7.4	+0.07	7.83

The results of all the comparisons are—

$$\Sigma \Delta (T) = -55.1, \Sigma \Delta (t) = 697.5, \Sigma \Delta (y) = +104.0 \text{ mic. div.}; \text{ error of adopted coefficient} = +0.15 \text{ mic. div.}$$

* This method was that first tried for the determination of the coefficient, but ultimately abandoned on account of the heated stove generating currents of air in the room and magnetometer boxes.

On three days the signs of $\Sigma \Delta (T)$ and of $\Sigma \Delta (t)$ are the same, namely, on January 23, March 22, and March 23 ; if the comparisons with these days be rejected, we have

$$\Sigma \Delta (T) = -253^{\circ}3, \Sigma \Delta (t) = 419^{\circ}1, \Sigma \Delta (y) = -39.9 \text{ mic. div.}; \text{ error of adopted coefficient} = -0.09 \text{ mic. div.}$$

In all the previous comparisons the signs of $\Sigma \Delta (T)$ and $\Sigma \Delta (t)$ are the same ; in this series they differ, and the coefficient is unaltered.*

70. In correcting the observations by this coefficient, no attention has been paid to the varying times of vibration in the vertical plane ; this, as has already been noticed, cannot be done. From the results in Table 16, it seems very doubtful if it should be done, as the correction deduced at various times does not seem to differ with the time of vibration. After correcting the observations made in the years 1844 and 1845 by the same coefficient, I was led, from the results, to suspect that some source of error still remained. Investigations for the temperature correction at different times throughout these years have shewn me that the coefficient in micrometer divisions is not constant, and that it varies from some cause which I have not as yet determined ; certainly, however, it does not vary directly with the time of vibration in the vertical plane, as theory would shew (49, 51.), but rather inversely ; this, however, and other facts in connexion with the 6th conclusion (50.), will be considered in the Introduction to the Observations for 1844. It will be enough to mention at present, that the results for the value of q' , in 1844 and 1845, vary from 7.0 to 10.0 micrometer divisions ; by the usual method, at the end of 1845, it would not exceed 3.0 micrometer divisions.

Bifilar Magnet.

71. The value of the temperature coefficient for the bifilar magnet, determined by temperature experiments on two days, which gave very consistent results, is

$$q = 0.000304,$$

See Table 19, Introduction, 1841-2 ; or if

$$k = 0.00013, q' = 2.34 \text{ scale divisions,}$$

this includes the theoretical correction for the expansion of the suspending silver wires and brass grooved wheels ; it did not seem improbable, however, that other sources of error might exist. The results for the balance needle shewed that this might be determined by comparisons of the daily observations ; such comparisons have been made, and the following Tables contain the results. The differences of the daily sums of the bifilar magnetometer readings are indicated by $\Delta (x)$, the results $\frac{\Sigma \Delta (x)}{\Sigma \Delta (t)}$ are given in scale divisions whose value = 0.00013.

* If other evidence of the accuracy of this method of determining the temperature coefficient should still be desired, I would refer to the coincidence of the results for the value of k , No. 51, and end of note, p. xxxvii.

TABLE 19.—Determinations of the Temperature Coefficient for the Bifilar Magnet, from Comparisons of the Daily Observations.

Period.	$t_p > t_{p+r}$			$t_p < t_{p+r}$			q'	
	$\Sigma \Delta (t)$	$-\Sigma \Delta (x)$	q'	$-\Sigma \Delta (t)$	$\Sigma \Delta (x)$	q'	Mean of results.	Mean result.
1844.	°	Sc. Div.	Sc. Div.	°	Sc. Div.	Sc. Div.	Sc. Div.	Sc. Div.
May 9—May 24	5334.9	13066.8	2.45	2359.9	4033.0	1.71	2.08	2.22
May 29—June 28	11938.2	24597.2	2.06	26719.2	45966.3	1.72	1.89	1.83
July 17—July 30	1843.1	3004.0	1.63	4637.8	8470.4	1.83	1.73	1.77
Sept. 2—Sept. 25	27322.6	53684.3	1.96	622.1	1260.8	2.03	1.99	1.96
Nov. 26—Dec. 13	17855.4	36791.6	2.06	2143.7	3104.5	1.45	1.76	1.99
For all the Periods	64294.2	131143.9	2.04	36482.7	62835.0	1.72	1.88	1.92

The mean of the two final results gives

$$q' = 1.90 \text{ scale divisions ; } q = 0.000247$$

this value of q has been adopted, and all the observations in this volume are corrected by the equivalent values in scale divisions.

72. The following Table (similar to Table 15) contains the particulars of the comparisons for intervals of different length, from May 14 till June 28, 1844.

TABLE 20.—Results of Comparisons at Different Intervals.

Interval between comparisons.	$t_p > t_{p+r}$				$t_p < t_{p+r}$				Result from all the comparisons.
	No. of comparisons.	$-\Sigma \Delta (x)$	$\Sigma \Delta (t)$	$\frac{-\Sigma \Delta (x)}{\Sigma \Delta (t)}$	No. of comparisons.	$\Sigma \Delta (x)$	$-\Sigma \Delta (t)$	$\frac{\Sigma \Delta (x)}{-\Sigma \Delta (t)}$	
Days.		Sc. Div.	°	Sc. Div.		Sc. Div.	°	Sc. Div.	Sc. Div.
1	5	142.8	169.2	0.8	8	311.6	300.0	1.0	1.0
2	4	229.8	118.2	1.9	8	656.8	457.9	1.4	1.5
3	4	459.5	217.7	2.1	8	1035.1	619.6	1.7	1.8
4	6	689.5	338.1	2.0	6	1255.5	650.5	1.9	2.0
5	6	811.2	479.1	1.7	7	1316.7	812.8	1.6	1.7
6	6	976.5	453.9	2.1	7	1574.1	896.7	1.8	1.9
7	7	1194.2	590.7	2.0	8	2097.9	1198.1	1.8	1.8
8	5	949.9	502.9	1.9	7	1894.9	1081.4	1.8	1.8
9	6	790.7	413.4	1.9	6	1821.9	1085.3	1.7	1.7
10	3	805.6	362.9	2.2	9	2030.1	1116.7	1.8	1.9
11	4	864.5	390.9	2.2	8	1970.3	997.0	2.0	2.0
12	5	1075.5	588.4	1.8	8	1989.7	1147.8	1.7	1.8
13	7	1324.3	698.2	1.9	6	1839.5	1087.9	1.7	1.8
14	6	1229.5	599.7	2.0	9	1940.1	1171.5	1.7	1.8
For all the } intervals. }	74	11543.5	5923.3	1.95	105	21734.2	12623.2	1.72	1.79

73. With the exception of the results of the values of $\frac{\Sigma \Delta (x)}{\Sigma \Delta (t)}$, where the comparisons have been of the readings on one day with those on the next following, the results are remarkably consistent for all intervals, and in *no* case does the result amount to that by temperature experiments; as an evidence, however, that the first results differ from the others only accidentally, the following is given, which contains all the comparisons made of the readings on one day with those on the day immediately following, with the exception already mentioned for the balance magnet, No. 68 :—

TABLE 21.—Results of Comparisons with One Day's Interval.

Period compared.	No. of comparisons.	$\Sigma \Delta t$	$\Sigma \Delta x$	q .
1844.		°		
May 9—May 24	11	884.8	Sc. Div. 1792.6	Sc. Div. 2.03
May 29—June 28	26	1262.8	1989.8	1.58
July 17—July 31	11	504.5	691.9	1.37
Sept. 2—Sept. 25	19	834.0	1551.9	1.86
Nov. 26—Dec. 13	15	842.9	1563.2	1.85
All the Periods	82	4329.0	7589.4	1.85

In this case it will also be remarked, that no partial result is as great as that from the temperature experiments.

74. As a farther evidence that the result obtained for this instrument is also independent of any cause, such as has been already suggested for the balance needle, the following Table contains the results of the comparisons on the *same* days as those already given for the balance needle, and on which the differences of temperature depend on artificial heat :—

TABLE 22.—Results of Comparisons when the Differences of Temperature depend on Artificial Causes.

Day of comparison.	Days compared with	No. of comparisons.	$\Sigma \Delta (T)$	$\Sigma \Delta (t)$	$\Sigma \Delta (x)$	Error of coefficient.	Resulting coefficient.
1843.	1843.		°	°			
Jan. 23	Jan. 18—21, 24—28	9	+63.4	130.2	Sc. Div. +36.3	Sc. Div. +0.29	Sc. Div. 1.61
Mar. 13	Mar. 16—21,	5	-21.2	28.1	-14.6	-0.52	2.42
Mar. 14	Mar. 16—21,	5	-27.5	26.1	-8.0	-0.31	2.21
Mar. 15	Mar. 16—21,	5	-29.0	28.1	+4.8	+0.17	1.73
Mar. 22	Mar. 16—21, 24—28	9	+79.1	62.4	+52.0	+0.83	1.07
Mar. 23	Mar. 16—21, 24—28	9	+55.7	79.5	+23.3	+0.29	1.71
Oct. 19	Oct. 14—18, 20—25	9	-41.2	99.6	+32.8	+0.33	1.57
Nov. 25	Nov. 21—24, 27—Dec. 1	9	-84.5	97.0	+29.9	+0.31	1.59
Dec. 21	Dec. 16—20, 22—27	9	-49.9	83.8	+1.4	+0.02	1.88

The quantities $\Delta(x)$ are obtained from the observations corrected by the coefficient q' corresponding to the value $q = 0.000247$ (as in this volume), but are reduced to scale divisions of the common value 0.00013. In one case only does the resulting coefficient exceed that by the temperature experiments. The final results are as follow :—

$$\Sigma \Delta(T) = -55^{\circ}1; \Sigma \Delta(t) = 634^{\circ}8, \Sigma \Delta(x) = +157.8 \text{ Sc. div.}; \text{ error of adopted coefficient} = +0.25 \text{ Sc. div.}$$

If the three days, January 23, March 22, and March 23, on which the sign of $\Sigma \Delta(T)$ is the same as the sign of $\Sigma \Delta(t)$, be rejected, we shall have

$$\Sigma \Delta(T) = -253^{\circ}3; \Sigma \Delta(t) = 362^{\circ}7, \Sigma \Delta(x) = +46.3 \text{ Sc. div.}; \text{ error of adopted coefficient} = +0.13 \text{ Sc. div.}$$

75. It is not necessary to reason on these results; the remarkable agreement of the partial results by all the methods is at once evident. A cause of the difference from the result by temperature experiments has been already pointed out, namely, the probable effect of temperature in diminishing the elasticity of the suspending wires. This source of error might be avoided by a silk suspension, but another of a much graver nature would be introduced, namely, the effect of varying humidity, which could not be eliminated.

76. All the observations of the bifilar magnetometer have been corrected by the equivalents in scale divisions of the coefficient $q = 0.000247$; the coefficients in scale division are given No. 39.

§ 8. INCLINOMETER.

77. The dip instrument was made by the late Mr ROBINSON of London. The vertical circle is $9\frac{1}{2}$ inches in diameter; it is divided to $10'$, the graduations counting from 0° on the horizontal to 90° on the vertical; $1'$ is estimated with the aid of lenses attached to a glazed case; the vertical circle turns with a copper framework on a vertical axis, centred in a horizontal circle; the latter is 6 inches in diameter, is divided to $30'$ and is read to $1'$ by means of a vernier. A sliding framework carrying Ys moves within that bearing the agate planes on which the axle of the needle rests, the Ys serve to lift and lower the needle on the agates, but they have been found to act very irregularly, at times giving the needle a pitch in a certain direction. A level screwed to the basement plate indicates the horizontality of the agates; this was, however, also verified occasionally by means of a small level placed upon them; it was found that the level varied according as the door of the case inclosing the instrument was shut or open; it was, therefore, always tested with the door shut, as it is during observations.

78. The reading of the horizontal circle, when the vertical circle is in the magnetic meridian, was obtained with the aid of a horizontal needle, carried on a pivot whose arms rest on the agate planes. There are two dipping needles, numbered 1 and 2, and one end of each needle is marked A, the other end is marked B; all the

marks are on one face of each needle. The needle is observed in four positions with one end dipping, namely, with the marked face of the needle on the same side as, and opposite to, the graduated face of the circle, the latter being in the meridian, first to the east, and then to the west; as each extremity of the needle is observed there are thus eight readings obtained. The poles being changed, and the other end dipping, other eight readings are similarly obtained. The means of the two readings for each position are given in this volume.

In changing the poles, the needle was placed on a small wooden block having a hole to receive the axle; it then received eight strokes on each face (as in the method of double touch) from two magnets, each 9 inches long, $\frac{3}{4}$ inch broad.

79. The inclinometer occupied the pillar I, in the plan (Plate I.), to the east of the declinometer pillar till May 30. 1843, when it was removed to the wooden house, described No. 24, where it was placed on a strong wooden post unconnected with the floor.

80. After June 1843, many of the observations were rendered valueless by the action of the lifter on the needle when the latter was in certain positions. The following notes to the observations made at the time will explain the nature of the difficulty:—

July 26. 1843. This observation made with great care, in order to determine if the apparent increase of dip is real, or only due to instrumental error. Every reading was determined by at least a dozen trials; the different trials varied little for the same position with one exception, in which the readings varied 10' on each side of the mean; there is, however, evidently something wrong with the lifter, as, on attempting to verify a reading marked (*a*), after the completion of the observation, only 73° 45' could be obtained, instead of 74° 0'.

August 1. 1843. As it was found that the lifter did not move freely last observation, it was taken out, cleaned, and bent a little, so as to fit better; to-day's observation was then made, but some other source of error exists, as there is a tendency, in lowering the needle on the planes, to move it always in one direction; the readings thus may be made to go on increasing, and, by a slight difference in the mode of lowering, they may be made to go on diminishing. It cost two hours to make the first reading, and the observation is not considered good.

September 12. 1843. Previous to this observation, the agate planes were adjusted to horizontality as accurately as the small level would permit. The observation was bad, but chiefly in the reading marked (*), 67° 30' was the reading generally gained, but after half-an-hour the needle rested at 68° 19'.

After this date the instrument was sent to Messrs ADIE and SON for adjustment, when the needle No. 1. was also adjusted.

The following are notes to the observations after the adjustment of the instrument:—

October 6. 1843. Observation not considered good—several of the readings

doubtful—the needle often has a tendency to read *any thing*, and is very irregular in its motions when lowered by the Ys. (Observer W.)

October 8. 1843. Needle No. 2. The readings are much better than with needle No. 1, but some of them are doubtful; when lowered by the Ys the needle sometimes leaps 2° or 3° . (Observer W.)

October 9. 1843. Needle No. 1. This observation was considered fair till the last reading, which might have been taken at any thing from 73° to 75° .

Same date. Needle No. 2. A fair observation; some of the readings, however, were not certain to about $5'$.

The observations were, in general, so unsatisfactory, that they were discontinued till Nov. 20; afterwards observations were made, which were, in general, more satisfactory.

81. Observations were made on April 18 and May 2, 1843, in different azimuths, in order to determine the correction due to the irregularity of the needle's axle, or perhaps to the presence of iron in the vertical circle; these observations have been already given (Table 21. and Table 22, Introduction, 1841-2.) The correction deduced was about $- 11'$ for needle No. 1. No correction has been applied to the results in this volume.

82. In 1846, the vertical circle was removed from the instrument and placed horizontally, the dip needle was suspended by a silk fibre within the circle, the needle and circle being in the same plane, the needle was then vibrated horizontally, and the zero of the graduations was placed in different azimuths; the time of vibration was found very little affected by the varying positions of the circle; it seems probable, therefore, that the correction above is due solely to the imperfections of the axle.

§ 9. BAROMETER.

83. The barometer is by NEWMAN. The tube is 0.552 inch in diameter; the scale is attached to a brass rod, terminating in an ivory point, which, at each observation, is made to meet its image in the mercury of the cistern; the cistern is about 3 inches in diameter; the vernier professes to read to 0.002 inch, and that 0.001 may be estimated, but the graduation is so inexact as to give changes in error from 0.002 to 0.003 inch. The barometer was compared indirectly with the standard of the Royal Society, by means of one made by NEWMAN for the DUKE of ARGYLE. The comparisons of the DUKE of ARGYLE's barometer with the flint and crown glass standards of the Royal Society are given Table 23, Introduction, 1841-2; they are not consistent; the mean gives

Correction of the DUKE of ARGYLE's standard barometer to those of the Royal Society
 $= - 0.009$ inch.

A consistent series of comparisons of the Makerstoun standard with the DUKE of ARGYLE's standard, given Table 24, Introduction, 1841-2, gives the mean

Correction of the Makerstoun standard barometer to the standard belonging to the
DUKE of ARGYLE = - 0.003 inch.

whence

Correction of the Makerstoun standard barometer to the standard barometers of the
Royal Society = - 0.012 inch.

84. All the observations are corrected to the Royal Society's standard barometer, and for temperature by SCHUMACHER's Tables, given in the Report of the Committee of Physics of the Royal Society.

The cistern of the barometer is 213 feet above the mean level of the sea at Berwick-upon-Tweed. (See No. 1.)

§ 10. THERMOMETERS.

85. The dry and wet bulb thermometers are by ADIE and SON. The bulbs are 0.3 inch in diameter, and tenths of a degree can be estimated on the scales; they are placed four inches apart on a wooden slab, the bulbs projecting below it. The slab was placed in the middle of a wooden case, the sides and top of which were formed like Venetian blinds, the case was open below and on the side next the Observatory; the thermometers, which were read from within, were about 9 inches distant from the west window on the north side of the building. As the thermometers were subject to the effect of radiation from the interior of the Observatory, the slab carrying them was, after January 24. 1843, fixed to the front of a wooden case with a slightly projecting top and sides, and with a double sloping back, the thermometers being 4 feet from the ground; the case revolves on a post, and can be turned from within the Observatory by means of cords and pulleys. When an observation is made, the case is turned till the thermometers face the window, being 9 inches distant from it; after reading, which is done through the glass (thus avoiding any source of error due to the proximity of the observer, or the light at night), the case is again turned till the thermometers face the west if the sun shine in the morning, the east if it shine in the evening, and the north at all other times, unless it rain, when the back of the case is turned to the wind, if any. Holes were cut in the front of the case immediately behind the bulbs of the thermometers, in order to give a free circulation to the air around them, and to prevent any effect from the different temperature of the wood; a small projecting ledge below carries the cistern of the wet bulb, and prevents, to some extent, the effect of radiation from the soil on the thermometers. It was found, early in the summer of 1843, that, in spite of all precautions, when the sun shines strongly before 7 A.M., or after 5 P.M., the thermometers are visibly affected by it. A moveable front, to which the thermometer slab was attached, was accordingly placed on the case, and, in the morning or

the evening when the sun shone, the front was removed and suspended at an equal height, on the west or east wall of the Observatory, being kept apart from it by projecting pins. Observations at different times shewed that, all other things being equal, the temperature was the same in all the positions; but when the sun shone it might be one or two degrees less to the east or west than to the north.

86. It sometimes happens when the air is very humid during frost, especially when the temperature is falling, that the dry bulb thermometer reads less than the wet bulb; when such is the case the readings of the wet bulb have not been printed in this volume, and in the summations for the abstracts the readings of the thermometers are considered as the same.*

87. The maximum and minimum register thermometers, on RUTHERFORD'S construction, were made by ADIE and SON. Before January 24, 1843, they were placed 4 feet from the ground, near the east window, facing the north, and were protected from the sun's rays in the morning and evening by projecting spars of wood. After January 24 they were placed on the same board with the dry and wet bulb thermometers, 5 feet from the ground.

88. The following table contains the corrections of the thermometers to a standard thermometer by NEWMAN. The comparisons were made in melting ice or snow for the freezing point, and in water at different temperatures. This table also contains the correction for the bifilar and balance thermometers, which have not been applied (see No. 33).

TABLE 23.—Corrections of Thermometers to the Standard by NEWMAN.

Temperature.	Dry.	Wet.	Max.	Min.	Bifilar (Ross).	Balance.
°	°	°	°	°	°	°
32	-0.7	-0.6	-0.1	+0.5	-0.1	-0.4
36	-0.6	-0.5			-0.1	-0.4
40	-0.6	-0.5	0.0	+0.5	-0.1	-0.5
45	-0.5	-0.4	+0.1		-0.3	-0.4
50	-0.4	-0.3	+0.2	+0.4	-0.5	-0.3
55	-0.4	-0.3	+0.3	+0.5	-0.5	-0.3
60	-0.4	-0.2	+0.4	+0.6	-0.4	-0.2
63	-0.3	-0.2			-0.3	-0.2
65				+0.7		
67	-0.1	0.0			-0.3	-0.2
70	+0.1	+0.2	+0.5		-0.2	-0.1
76	+0.2	+0.3	+0.7		-0.1	+0.2
79	+0.1	+0.3	+0.9		-0.1	+0.2

* The cause of this apparent anomaly, it is conceived, is this, that the moisture deposited on the silk cover of the wet bulb is frozen as it is deposited, until it becomes a thickish coat of silk and ice; the mercury in the bulb will thus, following the falling temperature of the air, contract slowly, and will be less affected by any evaporation proceeding on the outer surface of the coat; on the dry bulb, however, the frozen moisture is but a thin film, as the bulb is generally dried between the observations, it will thus be easily affected by any evaporation, and become, in fact, a wet bulb thermometer; it might be advisable, therefore, instead of rejecting to substitute the readings of the wet bulb for the dry, and the readings of the dry bulb for the wet.

No correction has been applied to the observations of the dry and wet bulb thermometers; the observations of the maximum and minimum register thermometers have been corrected, and all the *abstracts* of results for the dry and wet bulb thermometers.

§ 11. RAIN-GAUGES.

89. The rain-gauge (A) is placed in a space, enclosed by a paling on the top of the Observatory hill, with a good exposure on all sides. The funnel mouth is 6·1 inches in diameter, 8 inches above the soil, and 218 feet above the level of the sea. The quantity of rain is measured at noon by pouring it into a glass tube, graduated with reference to the aperture of the funnel.

90. The monthly results of two other gauges are given in the abstracts. One (B) is placed on the top of the greenhouse roof, 680 feet NNE. of the Observatory gauge; the funnel mouth is 6·7 inches in diameter, it is connected with a graduated tube within the greenhouse, it is 18 feet from the ground, and 192 feet above the level of the sea. This gauge is sheltered to the E. and NE. by trees, and its indications are therefore less trustworthy, especially during easterly winds; the amount of rain received in the funnel is also affected by the gusts of wind deflected from the sloping roof.

91. The other gauge (C) is in the middle of the Makerstoun garden, with a good exposure; the funnel mouth is 6·7 inches in diameter, is $6\frac{1}{2}$ feet above the soil, 171 feet above the level of the sea, and about 620 feet N. by E. of the Observatory gauge. The funnel is connected with a graduated tube. The greenhouse and garden gauges were observed by Mr MACGALL, the head-gardener.

§ 12. ANEMOMETER.

92. The anemometer consists of two separate parts, both made and erected by ADIE and SON; one gives the direction, the other the pressure, of the wind.

93. The vane is placed on the north wall of the Observatory, and, by means of a rod and gearing-wheels, it indicates the direction of the wind on a dial-plate within the building.

94. The anemometer proper, the invention of Mr R. ADIE of Liverpool, is placed at the north-east corner of the Observatory. This instrument will be best understood by a reference to the annexed figure; *a* is a cistern containing water to the level *b*, *c* being a turn-cock for letting the water off to the exact level, and *d* a glass gauge to shew when the water becomes too low, from evaporation or otherwise; an inverted vessel *e* is suspended in the water by a cord passing over the wheel *f*, whose axle rests on friction-rollers at *g* and *h*; *i* is a spiral which has a cord wrapped on it carrying a weight *k*, which balances the vessel *e*; *l* is a dial, graduated on the face near the circumference; *m* an index, attached to the common

axle of the wheel and spiral; n a loose index under the index m , which the latter carries forward by means of a projecting pin near the extremity; o a tube passing under the cistern a , which, entering the bottom, proceeds upwards within the vessel e till its open extremity is above the level of the water in a neck of the vessel e ; the other end of the tube o is six feet above the outer wall of the observatory, where it

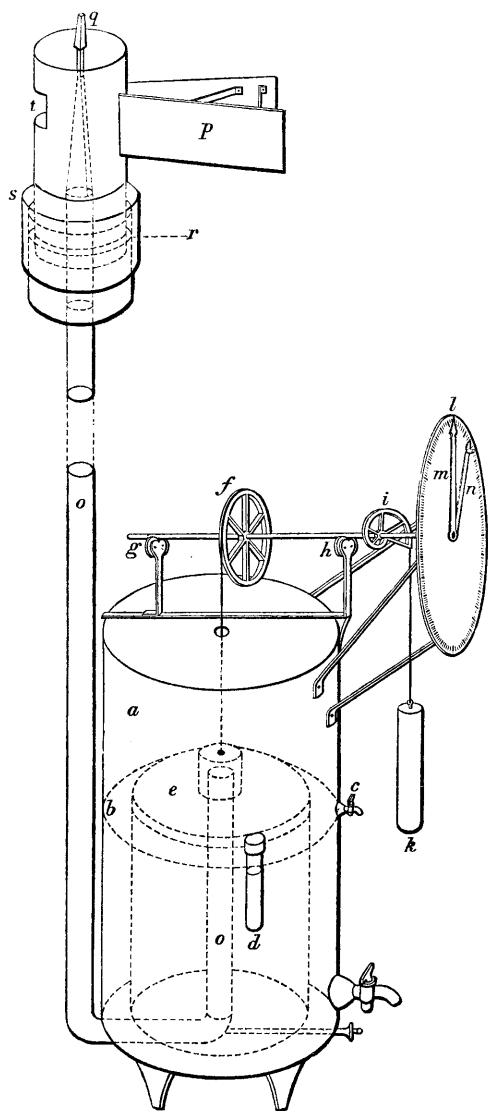

is capped by a vane p ; at the top of the tube o three brass rods are joined, which carry a small tube in which a pin within the top piece q rests or turns; the tube o is double at the top, containing between the tubes a quantity of mercury to the level r , the continuation of the cylindrical body of the vane enters the mercury, and a double portion s acts as an outer cover to the mercury cistern, t is an aperture, 2 inches square. When the wind blows, this aperture is presented to it, the wind then presses on the column of air within the tube o (being prevented from escaping under the vane by the mercury), and ultimately on the top surface of the vessel e , forcing the latter up, turning the axle carrying the index m , which carries before it the index n , leaving it at its farthest excursion. The dial is graduated as follows:—The surface of the top of the vessel e on which the wind presses is 78 square inches, therefore a pressure of 1 lb. on this surface is equivalent to $\frac{144}{78}$ lb. on a square foot. Different weights are suspended on the wheel f , acting oppositely to the vessel e , and the position of the index for each weight shews the pressure on a square foot of surface equal to the weight suspended multiplied by the above ratio. The spiral, on which the weight k acts, is the involute of a circle whose radius $r = \frac{R}{2\pi}$ where R is the radius of the

wheel f , and 2π is the circumference to radius of one, if the vessel e were homogeneous throughout its depth, the equal increments of motion in the index would correspond to equal increments of pressure.*

* The application of the involute of the circle as the spiral is due, I believe, to Professor FORBES. It is easily shewn that if the vessel e be homogeneous, w being the weight of a ring whose depth is one

95. The instrument is observed in the following manner:—About 2^m before the observation hour the pressure shewn by the index n is registered as the maximum pressure; this index is then put back to zero, and from 7^m to 10^m afterwards, the position to which it has again been carried by the index m is noted as the present pressure: the index n is then set to zero, and a similar double observation made at the next observation hour.

96. It is conceived that this instrument is trustworthy. It is occasionally, however, liable to slight derangements; the cup at the top containing mercury fills with rain, which, when frozen, prevents the vane from turning its aperture to the wind.

§ 13. STATE OF THE SKY.

97. The quantity of clouds is estimated, the whole sky covered with clouds being noted as 10, the complete absence of clouds being zero. The motions of the clouds are estimated as follows:—A well marked portion of cloud which passes through, or nearly through, the zenith, is watched till the direction is found in which it seems to run down, or parallel to, one corner of the Observatory; this direction is then estimated very nearly, as the walls are in the meridian and prime vertical. About the end of 1843, the points of the compass, with reference to each corner, were marked on the paling surrounding the Observatory. I have no hesitation in saying, that the motions of upper currents of air thus observed are much better determined than the motion of the lower or surface current by the vane.

98. The nomenclature adopted is that of Mr HOWARD, with certain combinations, which are, in general, sufficiently descriptive. The term *scud* refers to that loose, generally amorphous, and often rainy cloud, which is the lowest of all excepting the *stratus*.

§ 14. CLOCK, STOVE, AND COMPUTING ROOM.

99. The mean time clock in the Observatory is by DENT of London; it is kept at Göttingen mean time by means of comparisons with the transit clocks in the Astronomical Observatory, the errors of which are determined by Sir THOMAS BRISBANE, by myself, or my assistant. The rate of the mean time clock is kept small by placing small weights on, or taking them off, the bob of the pendulum.

inch, P the pressure which the wind exerts on the top of e diminishing its weight, β the corresponding arc through which the circumference of the wheel f moves (or the length of cord wrapped on the wheel), W the weight of the counterpoise k , and σ the specific gravity of the material (zinc) of which e is formed, then

$$\frac{P}{\beta} = \frac{W}{2\pi} + \frac{w}{\sigma}$$

a constant ratio.

100. A copper stove occupied the position S in the plan (Plate I.), and was lighted every day from January 1 till March 15, 1843, with one exception, namely, on January 23. It was only lighted three times again in 1843, namely, on October 19, November 25, and December 21, as it tended to increase the diurnal range of temperature, and to create aërial currents within the Observatory.

A small brick building was erected 24 yards to the east of the Observatory, which was occupied after March 16 as a computing room. It was determined that the bricks at that distance had no effect on the reading of the declinometer.

§ 15. DESCRIPTION OF THE TABLES OF OBSERVATIONS.

Daily Observations of Magnetometers, pages 1—28.

101. The first column contains the Göttingen mean time, astronomical reckoning, of the observations of the declination magnetometer. Göttingen time is $49^m 50^s$ in advance of Makerstoun time.

The second column gives the absolute westerly declination in degrees, minutes, and decimals, deduced as described, No. 23.

The third column contains the observations of the bifilar magnetometer in scale divisions, corrected for temperature to 26° Fahr., see Nos. 39 and 45; increasing numbers indicate increasing force. The bifilar is observed 2^m after the declination.

The fourth column contains the temperature of the bifilar magnet in degrees of Fahrenheit.

The fifth column gives the readings of the balance magnetometer in micrometer divisions, corrected for temperature to 26° Fahr., see No. 58; increasing numbers indicate increasing force. The balance is observed 3^m after the declination.

The sixth column contains the temperature of the balance needle in degrees of Fahrenheit.

102. At the foot of each page are given the declinometer torsion-circle readings for the torsion eliminated. A comparison of any one reading with the previous reading will give the number of degrees of torsion introduced between the two periods; 10° of torsion introduces an error into the observations of $0\cdot9$; references are made to footnotes, which at times indicate the cause that has produced the torsion, and the period that it may have existed. The value, k , of one scale division of the bifilar magnetometer, the whole horizontal force at Makerstoun being unity, is also given, together with the approximate value, k , of one micrometer division of the balance magnetometer, the whole vertical force being unity, obtained as in No. 55. The value used in the abstracts differs considerably, and is $k = 0\cdot000009$.

The observer's initial will be found at the same date of the meteorological observations.

Term-Day Observations of Magnetometers, pages 29—48.

103. The first column contains the minute in Göttingen mean time of the declination observation. The hour is given in the middle of each triplet of columns.

The second column gives the absolute westerly declination in degrees, minutes, and decimals.

The third column gives the bifilar magnetometer mean scale readings, corrected for temperature to 26° Fahr. The observations are made 2^m after those of the declination.

The fourth column contains the balance magnetometer micrometer readings, corrected for temperature to 26° Fahr. The observations are made 3^m after those of the declination.

104. The readings of the bifilar and balance thermometers at the commencement of each hour are given, together with the initial of the observer during the hour, at the foot of each page.

105. The corrections for temperature are applied thus :—The first observation (at the commencement) of each hour is corrected for the difference of the magnet's temperature at the hour from 26° Fahr., the corrections to the observations between the hours are then interpolated between the initial corrections.

Extra Observations of Magnetometers, pages 49—73.

106. These are observations made generally during magnetic disturbances. The same remarks apply with regard to temperature corrections, &c., as in the term observations, excepting that the Göttingen day and hour are given in the first column, and the minute is given for the observations of each instrument.

107. The observations of magnetic dip and absolute horizontal intensity require no other explanation than will be found in sections 4 and 8.

Daily Meteorological Observations, pages 86—197.

108. The first column contains the Göttingen mean time, astronomical reckoning, of the observations, all of which are made within a few minutes of the hour, and generally in a certain order. The Göttingen time is 49^m 50^s in advance of the Makerstoun time. The second column contains the readings of the barometer corrected for temperature, and to the Royal Society's standard barometers. See No. 83.

The third column gives the *observed* readings of the dry bulb thermometer in degrees Fahrenheit.

The fourth column contains the *observed* readings of the wet bulb thermometer.

The fifth column gives the differences of the readings of the dry and wet bulb thermometers.

The sixth column contains the readings of the maximum and minimum register thermometers, *corrected* by the quantities in Table 23. The minimum temperature of the night, read at 9 A.M. Makerstoun mean time, is immediately preceded by the maximum of the previous day, read at the same time.

The seventh column gives the readings, in inches and decimals, of the Observatory rain-gauge, made at noon.

The eighth column contains the maximum pressure of wind on a square foot of surface which has occurred since the previous observation, No. 95.

The ninth column contains the greatest pressure which occurs within 10 minutes at the time of observation ; titled the *present* pressure ; this is sometimes higher than the maximum previously recorded.

The tenth column gives the point of the compass from which the surface-wind blows, as observed on the vane-dial.

The eleventh column gives the points of the compass from which the clouds move, observed as described No. 97 ; when there are more motions than one observed, the motion of the lowest stratum of clouds is placed first, that is to say, next to the motion of the surface-wind in the tenth column ; the motion of the next higher stratum is separated from that of the lower stratum by a colon (:), and so with those higher still. Thus, July 12^d 18^h, while the motion of the surface-current was probably from WSW., the lowest stratum of clouds moved from NW., the next higher from NNW., and the highest clouds from SE. by S.

The twelfth column gives the estimated quantity of the sky covered with clouds, or the estimated surface of clouds compared with that of the whole hemisphere, the latter being 10.

109. The page opposite to these columns contains the species of clouds and general observations on the state of the sky or weather, as observed immediately after the observations of the meteorological instruments. The clouds whose motions have been defined are placed first, commencing with the lowest, and when several motions have been observed the strata are separated, as the directions are in the eleventh column, by colons (:); thus, in the above example, July 12^d 18^h. Scud moved from NW., cirro-cumulous scud from NNW., and cirri from SE. by S. When the directions in which any clouds move have not been determined, these are separated from the others by a cross +; in the previous example there was a thick mass of cirrous haze and cumulo-strati to E., whose motion was undetermined. The initial of the observer is given last ; and as the same person makes the magnetical and meteorological observations, the initials serve for the magnetical observations at the same hours.

Term-Day and Extra Meteorological Observations, pages 200—217.

110. These observations are made, during the magnetical term-days, at the solstices and equinoxes,* and on other occasions.

* The observations at the solstices and equinoxes were forwarded by Sir THOMAS BRISBANE to M. QUETELET of Brussels, and have appeared in his collection of " Observations des Phénomènes Périodiques," Mémoires de l'Académie Royale de Bruxelles.

The columns are the same as in the daily meteorological observations, excepting that the columns for the maximum and minimum thermometers are wanting.

ABSTRACT OF RESULTS, pages 219—305.

111. These Tables have appended or prefixed to them all requisite explanations, together with remarks on the conclusions deduced. It may be mentioned here, also, that in the *Tables* of Abstracts for the Magnetical Observations, summer consists of the months of May, June, and July, while, in the *Tables* of Abstracts for the Meteorological Observations, summer consists of the months of June, July, and August.

Curves of the Term-Day Observations after page 306.

112. The term-day observations have been projected and printed by a new process, which, as it may be of use in other cases, it may be desirable to describe here. Having obtained a sufficient number of *lithographed* copies of the curve paper, the observations were projected with the greatest accuracy, and the lines drawn with lithographic ink, by Mr WELSH; from these drawings the copies in this volume were obtained by the *Anastatic* process. The advantages of this method are, *1st*, the accuracy with which the observations are at once projected from the original observations (instead of being copies merely); *2d*, that the curve paper has only to be *drawn* once for all the curves; *3d*, that the expense is considerably less. The curve paper was prepared, and the curves were transferred by Mr R. APPEL, lithographic and anastatic printer, Ipswich.

GENERAL REMARKS.

113. It is perhaps desirable that some reasons should be given for the methods of reducing and printing the magnetical observations adopted in this volume.

114. The westerly declination has been given in the common units, degrees, and minutes, because the units *are* common; as it is as easy to give the variations of declination, with reference to the astronomical as to any other meridian, the printed observations are all *absolute*. They are thus at once comparable with all other observations which have been, or may be, reduced to the common units.

115. The bifilar and balance magnetometer readings are given in scale and micrometer divisions respectively, because *no* common unit of force has been yet agreed on, and because, in the case of the balance magnetometer, I had every reason to believe that an accurate value of the micrometer divisions had not been obtained. The *results* have been converted into parts of force, because it was necessary for conclusions on the variations of the total force and of the dip. If, however, the unit at different places must be variable, it seems desirable that it should be the same at the same place for the horizontal and vertical components and for the total force.

116. The observations of both the force magnetometers have been corrected for temperature, it is conceived, with a considerable approximation to accuracy; but not wishing to dogmatize in the use of a new mode of determining the temperature coefficient, I have, with Sir THOMAS BRISBANE'S leave, printed in all cases the temperatures of the magnets. In this, as in some other cases, I have preferred giving what may seem at present too much, rather than any one should afterwards have reason to find that I had given too little.

117. All the reductions have been made by my present assistants, Messrs WELSH and HOGG, and by myself. Each computation has been performed twice, and that generally by different individuals.

MAKERSTOUN, *June* 1846.

POSTSCRIPT.

Value of the Scale Divisions of the Bifilar Magnetometer in parts of the whole Horizontal Force.

118. A consideration of the theory of the bifilar magnetometer will shew that it is assumed that the suspending wires do not act at all by any elastic force; that, in fact, the force opposing the magnetic force is the resolved portion of that due to the weight suspended endeavouring to gain its lowest point, and, therefore, that if u be any angle from the magnetic meridian to which the magnet is deflected, the corresponding torsion of the wires being v (No. 35.), then $\frac{\sin u}{\sin v}$ is a constant ratio. If the assumption fail, there will be every reason to doubt the accuracy of the coefficient k , which depends on $\sin v$ and its *difference*. Any considerable error was not suspected; but the method described in the note, pages 2 and 3, having been found to answer so well for the determination of the coefficient for the balance needle, there was little doubt but that it would succeed much better for that of the bifilar magnet. Experiments were accordingly made when the previous Introduction was nearly through the press.

119. If the equation of equilibrium for the bifilar magnet when at right angles to the magnetic meridian be (No. 35.)

$$m X = f$$

and if a magnet, whose moment is M , be placed in the magnetic meridian, with its centre in the continuation of the bifilar magnet when at right angles to the magnetic meridian, and at a distance r from its centre, the resulting angle of deflection being Δv , equal n scale divisions, the equation of equilibrium will be (see the note already referred to),

$$m \left(X + \frac{c M}{r^3} \right) \cos \Delta v = f'$$

where f' is the force opposed to the magnetic force. For a horizontal force X' , which would alone have brought the magnet into this position the equation would have been

$$m X' \cos \Delta v = f'$$

whence

$$X' = X + \frac{c M}{r^3}$$

and

$$\frac{X' - X}{X} = \frac{\Delta X}{X} = \frac{c M}{r^3 X} = \frac{r_1^3 \tan u}{r^3 \cdot 2}$$

u being the deflection of a freely suspended magnet produced by placing the deflecting bar at right angles to the magnetic meridian, with its centre at a distance r_1 from the centre of the suspended magnet.

As k is the value of $\frac{\Delta X}{X}$ for one scale division

$$k = \frac{r_1^3 \tan u^*}{r^3 \cdot 2 n}$$

120. The results of the experiments made on two days, and at a different distance on each day, are,

First day, $k = 0.0001021$.

Second day, $k = 0.0001025$.

The value of k from the formula, $k = a \cot v$, being $k = 0.000125$. This difference is very considerable, so much so, that even though again delaying the publication of the Observations for 1843, I have determined to go over the various reductions in the abstracts, with the coefficients derived from the above in the following manner:— k being the coefficient given in Table 11, the coefficient used in the reductions in the abstracts of results is obtained from it in multiplying by $\frac{1023}{1250} = 0.8184$; 0.0001023 being the mean value of k obtained by deflections, and 0.0001250 the value of k obtained from the formula $k = a \cot v$. The coefficients used are therefore as follow:

Jan. 1^d—April 27^d 1843, $k = 0.0001021$,

April 28—Nov. 8 1843, $k = 0.0000986$,

Nov. 10—Dec. 31 1843, $k = 0.0001064$.

* It is obvious that the investigation for the balance magnet might be made in this way with advantage, the final equation in the note, p. xxxvi, would then stand thus—

$$k = \frac{r_1^3}{r^3} \cdot \frac{\tan u}{2 n \tan \theta}$$

DAILY OBSERVATIONS

OF

MAGNETOMETERS.

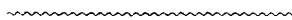

MAKERSTOUN OBSERVATORY,

1843.

DAILY OBSERVATIONS OF MAGNETOMETERS, JANUARY 1—18. 1843.

Göttingen Mean Time of Declination Observation.			DECLINA- TION.	BIFILAR.		BALANCE.		Göttingen Mean Time of Declination Observation.			DECLINA- TION.	BIFILAR.		BALANCE.			
				Cor- rected.	Thermo- meter.	Cor- rected.	Thermo- meter.					Cor- rected.	Thermo- meter.				
d.	h.	m.	°	Sc. Div.	°	Mic. Div.	°	d.	h.	m.	°	Sc. Div.	°	Mic. Div.	°		
Jan.	1	20	0	25 29.88	533.4	36.1	740.0	36.7	Jan.	11	20	0	25 23.43	535.0	47.3	778.1	50.3
		23	0	29.51	533.8	41.0	765.2	42.0			22	0	23.04	532.2	46.0	785.0	49.1
Jan.	2	2	0	29.62	530.0	49.8	778.2	50.2	Jan.	12	0	0	25.63	533.6	50.0	782.9	53.5
		5	0	25.04	536.6	53.9	846.6	54.9			2	0	25.85	540.0	52.1	773.5	54.5
		20	0	25 23.16	528.2	33.7	750.2	35.5			4	0	24.18	538.8	53.8	771.4	56.0
		23	0	30.43	532.1	43.0	785.8	45.0			6	0	23.77	536.1	51.3	773.4	53.1
Jan.	3	2	0	28.72	540.6	50.2	783.9	51.4			8	0	23.59	538.5	52.7	782.0	55.1
		5	0	27.00	539.9	50.7	789.8	51.8			10	0	21.44	537.1	53.3	786.2	56.4
		20	0	25 26.75	534.8	48.7	785.4	51.4			20	0	25 22.69	535.3	43.3	768.2	45.8
		23	0	26.72	531.8	49.0	787.4	50.5	Jan.	13	22	0	22.42	534.3	45.5	772.0	47.6
Jan.	4	2	0	29.28	536.0	51.8	789.8	52.8			0	0	25.56	534.4	48.0	775.4	49.7
		5	0	27.71	540.5	54.9	783.6	56.0			2	5	27.44	539.9	52.6	773.7	54.0
		20	0	25 26.77	537.4	48.8	774.9	51.0			4	0	538.4	52.8	782.5	53.8
		23	0	27.76	530.9	49.5	780.8	51.7			6	0	24.45	537.9	51.7	778.4	52.7
Jan.	5	2	0	29.15	541.8	56.3	778.9	59.0			8	0	27.29	539.6	52.7	782.1	54.0
		5	0	27.74	535.3	52.6	785.6	54.8			10	0	24.11	540.4	53.5	787.3	55.5
		20	0	25 27.02	533.8	45.0	773.4	47.3			20	0	25 24.98	536.4	46.9	775.3	49.5
		23	0	28.39	529.0	45.4	759.0	47.0	Jan.	14	22	0	23.79	529.8	45.4	781.2	47.7
Jan.	6	2	0	29.93	541.2	52.8	786.7	54.4			0	0	26.79	531.8	49.9	789.2	52.5
		5	0	26.33	546.0	59.7	786.9	59.7			2	0	28.18	540.9	54.4	783.6	56.5
		20	0	25 23.44	538.7	49.9	773.5	52.0			4	0	26.32	541.6	55.6	775.1	57.5
		23	0	25.27	538.3	52.8	785.2	55.2			6	0	25.32	539.1	52.1	780.8	54.1
Jan.	7	2	0	27.38	541.2	53.9	767.2	55.6			8	0	25.34	536.4	51.0	784.9	53.3
		5	0	24.33	539.2	54.5	755.5	54.8			10	0	24.77	535.3	52.1	788.3	54.8
		20	0	25 24.15	533.6	33.8	739.9	34.8	Jan.	15	18	0	25 23.68	538.1	42.3	768.4	44.2
Jan.	8	22	0	24.13	533.3	35.1	758.3	36.3			20	0	25.81	542.9	47.1	761.5	48.8
Jan.	9	0	0	26.26	539.6	43.3	763.0	45.0			22	0	24.99	537.9	46.8	766.5	48.2
		2	0	29.33	555.5	53.1	801.1	56.6	Jan.	16	0	0	28.52	540.0	48.9	766.9	50.0
		4	0	26.57	538.4	50.0	733.3	49.5			2	0	33.10	546.4	51.8	766.0	53.3
		6	0	25.93	541.5	49.5	760.3	48.5			4	0	29.26	547.3	54.9	775.5	56.4
		8	0	25.32	540.7	50.3	782.9	51.7			6	0	26.05	547.6	53.7	775.6	55.3
		10	0	23.27	544.1	56.5	778.2	57.9			8	0	25.11	544.2	54.0	773.6	55.5
		20	0	25 24.77	531.9	46.4	757.8	46.8			10	0	24.01	543.1	54.2	773.0	56.0
		22	0	25.41	532.0	46.5	770.8	47.8	Jan.	17	18	0	25 26.22	539.9	50.0	771.3	52.3
Jan.	10	0	0	26.79	535.6	48.8	775.8	50.5			20	0	24.77	545.9	55.3	770.6	58.3
		2	0	28.03	540.1	50.8	775.0	53.0			22	0	25.18	538.7	53.8	766.6	55.8
		4	0	25.96	542.1	54.0	771.8	56.8			0	0	26.06	537.2	53.1	767.8	55.4
		6	0	26.01	539.3	51.9	785.1	54.0			2	0	27.61	539.0	54.0	770.5	56.1
		8	0	23.39	541.4	51.8	785.5	54.4			4	0	27.47	542.7	58.3	778.2	60.4
		10	0	22.72	542.0	53.6	786.6	56.5			6	0	26.73	532.2	56.0	790.0	57.8
		20	0	25 23.26	538.5	49.9	827.1	52.5			8	0	23.90	538.1	56.2	785.5	58.0
		22	0	23.29	535.8	49.4	778.4	52.2			10	0	22.74	537.9	56.8	782.5	58.6
Jan.	11	0	5	25.76	534.0	49.2	778.1	51.5	Jan.	18	18	0	25 23.98	540.8	55.2	767.5	57.0
		2	0	26.72	545.3	53.8	785.2	56.0			20	0	24.08	541.0	56.4	774.6	58.2
		4	0	26.20	542.3	52.9	759.3	55.5			22	0	23.88	536.1	56.9	769.8	58.6
		6	0	25.48	540.6	52.1	773.2	54.2			0	7	27.49	534.0	57.4	771.4	59.0
		8	8	23.01	527.0	52.7	834.4	54.9			2	0	28.35	538.7	57.7	771.4	59.3
		10	0	22.06	531.4	52.6	811.0	55.7			4	0	27.16	540.5	57.2	780.4	58.6
											6	0	25.56	541.1	57.6	777.4	59.0
											8	0	29.33	537.5	57.7	774.8	59.0
											10	0	27.36	533.5	56.8	781.8	58.2

DECLINATION. Torsion removed, circle reading,—Dec. 20^d 1842, 168°; Jan. 2^d 21^h, 194°; * 6^d 6^h, 224°; * 9^d 21^h, 249°; 13^d 2^h, 32°; † 16^d 23^h, 14°.

BIFILAR. $k=0.0001248$.

BALANCE. $k=0.000015$ approximately.

* Jan. 24 21^h. It is probable that this change in the plane of detorsion was produced in taking out the magnet in order to make the Dip observation; it was found ultimately that two fibres of the suspension thread had been broken. It is conceived that one fibre had been broken in taking out the magnet, and another on replacing it, from the great change of torsion found on January 6.

† Jan. 13^d 25 39^m. After an observation for the value of $\frac{H}{F}$ the broken fibres mentioned above were withdrawn, and the torsion eliminated.

Jan. 17^d 0^h. The Declination observation was 20^m late on account of the torsion being removed from the suspension thread.

Göttingen Mean Time of Declination Observation.			DECLINA- TION.		BIFILAR.		BALANCE.		Göttingen Mean Time of Declination Observation.			DECLINA- TION.		BIFILAR.		BALANCE.	
					Cor- rected.	Thermo- meter.	Cor- rected.	Thermo- meter.						Cor- rected.	Thermo- meter.		
d.	h.	m.	°	'	Sc. Div.	°	Mic. Div.	°	d.	h.	m.	°	'	Sc. Div.	°	Mic. Div.	°
Jan. 18	18	0	25	27.81	538.5	60.8	755.8	61.8	Jan. 25	18	0	25	25.27	537.4	59.3	757.9	61.0
	20	0		27.98	536.2	59.5	747.7	62.0		20	0		24.87	537.9	58.8	760.3	60.3
	22	0		27.78	532.5	59.3	763.3	61.0		22	0		24.06	530.9	58.3	765.5	60.0
Jan. 19	0	0		29.83	529.3	58.3	771.8	59.8	Jan. 26	0	0		27.22	531.6	58.9	769.8	60.8
	2	0		31.99	533.4	58.3	775.1	60.0		2	0		28.94	535.7	59.7	759.1	61.4
	4	0		30.00	542.1	59.0	780.8	60.3		4	0		26.48	537.6	59.4	765.9	61.0
	6	0		29.04	540.7	60.3	767.9	61.5		6	0		25.76	538.3	59.2	762.0	61.0
	8	0		27.85	538.0	60.3	758.1	61.5		8	0		24.10	529.9	59.0	768.2	60.5
	10	0		25.48	533.4	59.2	769.4	60.5		10	0		22.62	534.7	60.0	769.1	62.6
	18	0	25	27.29	537.2	55.8	773.1	57.4		18	0	25	24.33	540.9	60.7	752.1	62.4
	20	0		27.40	538.7	55.9	774.3	57.8		20	0		24.77	540.5	60.9	751.2	62.5
	22	0		27.17	533.3	55.3	775.5	56.8		22	0		25.27	534.2	60.3	756.6	61.6
Jan. 20	0	0		30.55	539.7	56.1	777.0	57.5	Jan. 27	0	0		28.28	536.5	60.7	764.2	62.3
	2	0		32.02	532.5	56.7	776.9	57.8		2	0		29.31	540.3	60.8	757.7	62.5
	4	0		31.73	540.7	57.9	776.2	59.0		4	0		26.55	542.1	60.5	756.9	62.0
	6	0		29.98	538.3	57.2	779.7	58.6		6	0		26.35	541.5	60.2	753.9	61.7
	8	0		29.62	536.8	56.7	773.1	58.2		8	0		25.66	543.4	62.4	747.8	64.0
	10	0		28.27	537.6	55.7	774.9	57.0		10	0		25.41	539.5	63.2	746.5	64.6
	18	0	25	29.36	536.4	49.8	778.8	52.0		18	0	25	21.31	538.9	57.8	711.5	58.7
	20	0		29.08	543.4	53.0	778.9	55.8		20	0		24.11	539.6	57.9	744.8	59.4
	22	0		28.57	534.1	50.8	776.9	52.9		22	0		23.95	535.4	58.2	758.4	60.0
Jan. 21	0	8		30.48	534.6	52.7	775.6	55.0	Jan. 28	0	0		32.72	531.3	58.7	758.2	60.3
	2	0		29.69	539.2	53.4	774.0	55.3		2	0		29.75	537.2	58.8	755.5	60.5
	4	0		27.00	540.4	53.9	774.8	55.5		4	0		29.31	539.9	58.2	765.2	59.6
	6	0		26.25	541.5	55.2	776.1	56.7		6	0		26.66	526.5	56.2	859.4	57.2
	8	0		25.46	540.8	54.9	771.6	56.5		8	0		20.87	524.2	55.6	842.0	57.2
	10	0		24.67	539.1	54.3	765.7	56.0		10	0		20.88	533.1	58.5	805.2	61.0
Jan. 22	18	0	25	25.14	531.1	42.2	733.5	43.8	Jan. 29	18	0	25	24.48	540.6	54.3	723.1	55.0
	20	0		24.53	533.2	42.3	740.5	43.0		20	0		25.34	535.4	54.8	751.6	56.4
	22	0		23.30	527.3	41.8	746.8	42.4		22	0		22.94	531.7	54.6	756.6	55.8
Jan. 23	0	0		25.68	528.6	42.2	751.0	42.7	Jan. 30	0	0		26.67	533.3	54.0	755.9	55.4
	2	0		29.65	534.1	43.0	741.2	43.4		2	0		28.54	532.2	57.3	770.1	58.9
	4	0		27.13	536.5	44.0	749.2	44.1		4	0		25.59	542.9	59.8	767.4	61.5
	6	0			6	0		24.55	534.9	58.7	767.3	60.0
	8	0		20.40	535.6	44.0	746.0	44.2		8	0		24.10	533.4	56.7	772.1	58.1
	10	0		23.59	533.7	44.2	743.8	44.5		10	0		22.69	537.1	58.8	768.4	61.0
	18	0	25	21.29	537.1	52.1	735.1	51.8		18	0	25	23.39	538.8	58.3	754.3	60.0
	20	0		24.30	543.0	53.7	740.7	53.4		20	0		24.35	535.7	56.7	757.9	58.4
	22	0		23.06	537.2	54.7	744.8	54.9		22	0		24.00	536.0	56.7	762.4	58.4
Jan. 24	0	0		26.70	534.3	56.3	743.7	56.5	Jan. 31	0	0		25.88	530.4	59.0	764.1	60.6
	2	0		28.15	537.2	56.9	741.1	57.2		2	0		26.79	532.2	60.9	765.8	62.3
	4	0		26.26	539.0	57.4	750.6	58.2		4	0		25.39	538.3	61.0	764.1	62.5
	6	0		24.87	539.9	57.0	750.1	58.3		6	0		24.48	531.9	59.0	758.8	60.5
	8	0		25.14	540.8	57.7	751.8	59.1		8	0		25.31	536.6	58.8	751.2	60.0
	10	0		25.46	542.1	57.9	754.6	59.5		10	0		24.04	537.8	59.7	753.9	61.0
	18	0	25	22.43	534.2	55.9	741.9	57.5		18	0	25	24.03	532.6	54.7	739.5	56.6
	20	0		24.60	535.0	55.9	751.2	57.8		20	0		24.28	538.2	56.8	764.7	59.5
	22	0		25.43	531.5	55.7	758.9	57.0		22	0		25.43	534.5	55.6	762.8	58.0
Jan. 25	0	0		27.19	532.5	58.0	763.5	60.7	Feb. 1	0	0		26.94	535.3	54.5	762.0	56.5
	2	0		29.65	536.3	58.8	767.2	61.1		2	0		27.14	536.3	54.9	762.1	56.5
	4	0		28.07	540.9	59.8	775.5	61.6		4	0		24.74	539.2	59.5	762.2	61.3
	6	0		26.10	538.9	58.9	771.1	60.5		6	0		25.41	535.5	58.0	759.9	59.7
	8	0		25.95	539.4	59.4	772.6	61.2		8	0		24.47	537.2	58.3	759.0	60.0
	10	0		25.09	535.3	59.4	768.0	61.3		10	0		23.95	535.9	57.8	757.9	59.7

DECLINATION. Torsion removed, circle reading,—Jan. 23^d 23^h 4^m; 28^d 3^h 18^m; 30^d 23^h 18^m.
 BIFILAR. $k=0.0001248$. BALANCE. $k=0.000015$ approximately.

Jan. 31^d 6^h 30^m. Declination reading 25° 17' 88".

DAILY OBSERVATIONS OF MAGNETOMETERS, FEBRUARY 1—15, 1843.

Göttingen Mean Time of Declination Observation.			DECLINA- TION.	BIFILAR.		BALANCE.		Göttingen Mean Time of Declination Observation.			DECLINA- TION.	BIFILAR.		BALANCE.					
				Cor- rected.	Thermo- meter.	Cor- rected.	Thermo- meter.					Cor- rected.	Thermo- meter.	Cor- rected.	Thermo- meter.				
d.	h.	m.	°	'	Sc. Div.	°	Mic. Div.	°	d.	h.	m.	°	'	Sc. Div.	°	Mic. Div.	°		
Feb.	1	18	0	25	25.02	538.5	55.0	765.4	57.5	Feb.	8	18	0	25	22.02	536.3	55.2	743.6	57.0
		20	0		24.37	537.8	54.2	760.4	56.6			20	0		24.64	536.5	54.7	753.4	56.5
		22	0		24.64	534.1	52.3	767.4	54.8			22	0		23.97	528.9	53.0	759.9	55.0
Feb.	2	0	0		25.95	538.0	55.0	770.5	57.5	Feb.	9	0	0		28.00	529.4	56.0	753.2	58.5
		2	0		28.42	538.3	56.0	762.6	58.3			2	0		30.79	533.0	54.5	754.8	56.5
		4	0		25.09	537.7	55.4	765.5	57.5			4	0		29.51	535.7	54.8	771.5	57.2
		6	0		24.82	536.9	53.0	771.4	55.4			6	0		29.48	530.5	50.4	740.4	52.2
		8	0		25.01	537.6	52.3	770.1	54.7			8	0		25.75	537.5	52.2	765.6	55.1
		10	0		24.60	537.6	53.8	762.2	56.3			10	0		25.09	533.4	51.0	767.1	53.5
		18	0	25	25.11	536.4	48.0	758.3	49.2			18	12	25	26.20	532.1	44.7	755.4	46.6
		20	0		24.60	539.1	48.9	765.8	51.2			20	0		26.08	539.2	47.0	749.2	49.0
		22	0		24.67	531.8	49.0	766.8	51.2			22	0		24.78	532.6	45.8	756.1	47.5
Feb.	3	0	0		26.99	535.3	50.9	756.8	52.9	Feb.	10	0	0		28.64	535.2	49.4	752.3	51.1
		2	0		27.26	540.8	53.9	751.4	55.7			2	0		30.13	534.5	49.9	761.5	51.2
		4	0		25.14	538.0	52.8	754.5	54.6			4	0		28.72	540.2	53.7	757.5	55.5
		6	0		25.11	536.4	49.8	769.1	51.3			6	0		25.54	539.7	52.0	764.2	53.4
		8	0		24.27	539.3	49.9	763.8	52.7			8	0		22.27	536.5	52.9	767.5	54.6
		10	0		23.79	537.8	49.1	767.2	53.0			10	0		24.77	541.1	53.7	756.9	55.5
		18	0	25	24.53	542.0	43.0	763.5	46.7			18	0	25	24.40	536.8	48.6	744.8	50.5
		20	0		23.03	544.5	47.8	757.2	50.5			20	0		24.64	537.4	48.7	754.9	50.6
		22	0		23.46	538.9	46.8	757.8	49.2			22	0		23.46	527.8	47.3	739.6	49.0
Feb.	4	0	0		24.74	540.1	50.8	748.5	53.2	Feb.	11	0	0		26.69	533.0	46.1	740.4	48.0
		2	0		26.57	543.7	53.1	746.1	55.5			2	0		28.50	530.1	45.6	737.8	47.3
		4	0		24.51	545.4	54.5	749.0	57.0			4	0		25.78	534.9	44.9	724.2	45.8
		6	0		23.59	544.7	51.0	753.8	53.5			6	3		24.60	535.5	44.9	727.8	45.6
		8	0		24.47	545.7	53.0	745.5	56.9			8	0		25.27	541.2	48.0	739.0	50.5
		10	0		23.64	545.0	52.9	750.1	56.0			10	0		22.69	541.7	52.5	743.7	54.2
Feb.	5	18	0	25	23.50	556.6	41.3	741.8	43.7	Feb.	12	18	0	25	19.73	535.7	43.8	721.1	44.8
		20	0	25	23.83	534.9	39.8	752.2	42.3			20	0		21.04	549.0	46.3	728.7	48.5
		22	0	25	24.00	530.7	39.1	743.0	41.5			22	0		24.10	535.1	46.0	735.3	47.5
		0	0	25	26.55	538.1	43.5	743.4	47.8	Feb.	13	0	0		28.00	536.1	49.8	733.3	52.2
Feb.	6	2	0	25	33.34	539.0	51.6	741.3	53.4			2	0		29.98	539.6	50.0	731.6	50.5
		4	0	25	26.96	546.6	53.4	741.0	55.5			4	0		30.71	541.8	50.4	751.0	52.0
		6	0	25	28.54	539.5	49.8	769.1	51.6			6	0		28.94	536.5	49.7	765.4	50.7
		8	0	25	21.04	532.1	52.1	806.8	54.2			8	0		25.83	541.5	51.7	760.0	53.5
		10	0	24	44.31	538.7	53.2	830.1	55.0			10	0		8.17	531.1	50.9	770.0	52.9
		19	0	25	23.79	536.8	47.8	736.6	49.6			18	20	25	26.30	531.0	45.6	728.0	47.1
		20	0		24.17	540.0	48.4	753.1	50.2			20	0		29.88	529.9	45.8	697.7	48.1
		22	0		22.94	543.1	49.9	751.1	51.5			22	0		23.97	538.1	46.7	724.6	48.8
Feb.	7	0	0		27.85	527.7	50.9	750.8	52.3	Feb.	14	0	0		29.51	535.8	46.0	741.8	48.1
		2	0		32.64	533.6	54.3	762.4	56.8			2	0		32.62	535.8	46.0	761.1	48.6
		4	0		31.06	544.5	57.2	761.3	59.0			4	0		26.06	537.0	47.2	776.4	49.5
		6	0		26.01	540.9	55.7	776.0	57.0			6	0		24.10	533.0	44.7	778.1	46.3
		8	0		24.91	536.3	55.0	771.7	56.7			8	0		21.44	526.1	44.9	773.0	47.7
		10	0		24.33	537.2	56.2	758.4	58.3			10	0		22.67	522.9	45.2	756.9	48.6
		18	0	25	24.13	533.0	51.9	754.2	53.5			18	0	25	22.99	526.8	37.2	742.5	40.0
		20	0		24.13	541.1	53.3	755.4	55.4			20	0		24.55	537.0	40.1	751.3	43.5
		22	0		25.95	534.9	52.6	749.4	54.0			22	0		24.60	534.4	40.6	750.0	44.0
Feb.	8	0	0		29.14	533.9	54.8	760.0	56.5	Feb.	15	0	0		26.37	537.8	43.7	743.3	46.1
		2	0		30.79	536.6	56.2	761.0	57.6			2	0		29.42	539.2	47.4	740.2	49.0
		4	0		26.97	540.4	57.9	759.1	59.2			4	0		27.19	538.4	51.4	755.5	52.6
		6	0		26.03	540.7	57.6	756.2	59.0			6	0		21.49	539.1	51.3	765.1	52.6
		8	0		25.29	541.3	59.1	747.3	60.7			8	0		24.64	541.1	52.0	755.8	54.0
		10	0		23.86	537.8	58.2	749.7	60.0			10	0		21.24	538.0	51.0	742.8	53.0

DECLINATION. Torsion removed, circle reading.—Feb. 3^d 10^h, 28°; 6^d 23^h, 28°; 13^d 23^h, 28°.
 BIFILAR. $k=0.0001248$. BALANCE. $k=0.000015$ approximately.

Feb. 6^d 19^h. Observation 1^h late.
 Feb. 13^d 18^h 22^m. The Balance magnet vibrating considerably.

Göttingen Mean Time of Declination Observation.			DECLINA- TION.		BIFILAR.		BALANCE.		Göttingen Mean Time of Declination Observation.			DECLINA- TION.		BIFILAR.		BALANCE.	
					Cor- rected.	Thermo- meter.	Cor- rected.	Thermo- meter.						Cor- rected.	Thermo- meter.		
d.	h.	m.	°	'	Sec. Div.	°	Mic. Div.	°	d.	h.	m.	°	'	Sec. Div.	°	Mic. Div.	°
Feb. 15	18	0	25	24.20	530.0	40.0	750.2	42.6	Feb. 22	18	0	25	22.65	535.3	47.3	742.0	50.2
	20	0		24.40	538.9	44.9	750.1	47.9		20	0		23.39	539.8	50.2	744.2	52.0
	22	0		24.77	533.4	42.4	750.2	45.1		22	0		25.05	535.3	49.4	740.6	51.0
Feb. 16	0	0		27.70	534.0	46.1	744.3	48.6	Feb. 23	0	0		27.96	535.0	49.6	741.5	51.3
	2	0		29.31	543.3	50.2	730.0	51.8		2	0		28.84	540.1	51.7	735.0	53.0
	4	0		26.96	544.6	52.7	748.7	54.0		4	0		27.09	540.6	51.7	743.8	53.1
	6	0		27.34	542.0	50.2	756.1	51.5		6	0		26.17	543.2	50.8	744.3	52.5
	8	0		14.06	543.8	50.1	767.8	52.3		8	0		25.09	540.1	50.3	750.5	52.0
	10	0		23.19	537.8	50.3	760.6	52.7		10	0		25.12	538.3	50.5	747.9	51.9
	18	0	25	24.64	533.1	41.4	737.8	44.0		18	0	25	21.24	544.1	50.8	725.2	52.2
	20	0		24.53	541.9	45.2	743.7	48.5		20	0		21.51	543.9	50.8	723.0	52.1
	22	0		24.48	541.5	46.4	742.1	49.7		22	0		27.38	528.7	49.7	725.8	51.2
Feb. 17	0	0		26.37	539.1	47.9	737.2	50.1	Feb. 24	0	0		32.27	539.1	50.7	727.8	52.2
	2	0		26.70	540.7	53.0	742.8	55.1		2	0		34.68	538.6	51.1	735.9	52.5
	4	0		28.07	541.1	54.1	748.9	55.7		4	0		43.60	535.2	51.7	794.1	53.0
	6	0		28.07	533.3	51.8	770.2	53.1		6	0		30.62	528.9	52.0	878.6	53.4
	8	0		24.94	540.8	51.0	766.6	53.4		8	0		26.79	523.5	52.9	887.8	54.6
	10	0		23.50	539.2	49.4	758.4	51.8		10	0		20.16	527.0	52.7	783.2	54.2
	18	0	25	23.43	529.3	37.9	707.1	41.0		18	0	25	27.85	539.2	53.4	701.2	55.8
	20	0		24.25	539.7	41.3	752.8	44.9		20	0		25.58	534.5	53.8	734.2	55.8
	22	0		24.17	530.5	38.0	750.8	41.2		22	0		26.35	529.3	53.0	743.4	55.0
Feb. 18	0	0		26.06	536.5	44.5	741.6	47.5	Feb. 25	0	0		28.03	528.2	52.9	745.9	54.9
	2	0		27.80	541.7	48.8	733.3	50.1		2	0		28.70	535.7	53.1	748.6	54.9
	4	0		25.85	542.9	52.1	737.3	52.8		4	0		27.70	536.9	52.4	748.5	54.0
	6	0		26.62	539.3	51.9	745.0	52.5		6	0		27.19	534.5	51.3	750.1	53.0
	8	0		22.11	540.8	52.0	752.6	53.5		8	0		25.95	536.1	52.2	742.8	53.8
	10	0		24.00	540.8	51.1	746.8	53.0		10	0		16.40	544.3	53.0	743.2	54.7
Feb. 19	18	0	25	22.82	530.1	38.1	730.3	39.5	Feb. 26	18	0	25	25.68	536.6	42.7	745.5	44.6
	20	0		23.56	541.3	43.0	734.2	44.7		20	0		25.41	536.4	43.6	741.2	45.5
	22	0		23.71	536.4	43.1	739.3	44.4		22	0		26.25	533.7	44.2	742.5	46.0
Feb. 20	0	0		25.95	535.4	47.0	732.4	48.5	Feb. 27	0	0		27.67	536.5	47.0	742.1	48.5
	2	0		27.60	535.7	49.2	736.2	50.7		2	0		27.56	542.0	49.5	750.3	50.7
	4	0		25.65	541.0	50.1	745.4	51.6		4	0		25.52	542.7	51.7	745.5	53.0
	6	0		23.32	530.9	46.6	770.7	48.5		6	0		24.74	539.7	50.2	739.0	51.3
	8	0		24.47	539.4	47.4	758.9	49.5		8	0		23.86	538.7	48.9	749.1	50.5
	10	0		23.12	540.7	49.7	741.8	50.3		10	0		24.60	537.0	48.9	749.9	50.6
	18	0	25	22.85	535.6	45.9	741.2	48.2		18	0	25	23.81	535.0	43.9	745.7	46.0
	20	0		22.87	538.4	48.2	740.6	50.0		20	0		23.19	539.5	46.8	742.1	48.8
	22	0		24.53	531.3	46.8	740.2	48.5		22	0		25.95	532.6	45.8	740.0	47.5
Feb. 21	0	0		29.44	531.9	47.7	734.0	49.4	Feb. 28	0	0		31.93	533.9	46.7	729.2	48.1
	2	0		28.68	536.2	50.0	737.3	51.8		2	0		28.86	544.3	49.8	734.0	51.0
	4	0		26.77	541.0	52.7	746.2	54.5		4	0		25.46	540.7	51.3	742.3	52.3
	6	0		24.47	541.2	51.7	745.8	53.4		6	0		24.67	538.0	50.3	739.0	51.3
	8	0		24.53	541.0	52.1	743.5	53.6		8	0		23.93	540.1	50.1	739.7	51.3
	10	0		23.12	536.4	51.9	741.7	53.3		10	0		23.93	539.0	49.3	739.0	50.7
	18	0	25	23.63	537.3	49.5	740.1	51.3		18	0	25	23.06	538.8	44.6	745.7	46.7
	20	0		23.07	538.0	51.9	742.0	54.0		20	0		23.53	538.2	44.6	739.1	46.9
	22	0		24.47	531.7	50.2	739.7	51.9		22	0		24.06	534.4	44.2	735.9	46.5
Feb. 22	0	0		29.38	533.1	52.2	727.4	54.0	Mar. 1	0	0		25.34	533.6	45.7	731.9	47.5
	2	0		29.55	538.8	53.0	733.7	54.7		2	0		26.66	540.1	51.2	731.7	52.5
	4	0		28.59	536.8	52.8	747.0	54.5		4	0		25.95	538.0	52.1	731.3	53.2
	6	0		25.27	538.4	51.4	749.4	53.0		6	0		24.60	537.5	51.0	734.7	52.0
	8	0		24.91	542.5	51.6	749.5	53.4		8	0		24.60	539.6	49.1	736.6	50.5
	10	0		25.24	538.7	51.3	748.2	53.0		10	0		24.20	538.8	49.2	734.8	50.8

DECLINATION. Torsion removed, circle reading,—Feb. 20^d 23^h, 28°; 27^d 23^h, 28°.
 BIFILAR. $k=0.0001248$. BALANCE. $k=0.000015$ approximately.

Göttingen Mean time of Declination Observation.			DECLINA- TION.	BIFILAR.		BALANCE.		Göttingen Mean Time of Declination Observation.			DECLINA- TION.	BIFILAR.		BALANCE.					
				Cor- rected.	Thermo- meter.	Cor- rected.	Thermo- meter.					Cor- rected.	Thermo- meter.	Cor- rected.	Thermo- meter.				
d.	h.	m.	°	'	Sec. Div.	°	Mic. Div.	°	d.	h.	m.	°	'	Sec. Div.	°	Mic. Div.	°		
Mar.	1	18	0	25	22-67	540-9	44-9	741-7	47-3	Mar.	8	18	0	25	23-70	533-7	47-3	754-9	49-5
		20	0		23-26	541-5	45-9	736-2	48-0			20	0		22-90	533-4	46-8	756-6	48-8
		22	0		23-73	534-6	44-8	742-0	46-8			22	0		24-01	525-9	45-8	757-9	47-8
Mar.	2	0	0		27-94	532-5	47-7	729-7	49-5	Mar.	9	0	0		28-20	530-0	47-7	746-6	49-0
		2	0		27-96	536-8	48-2	735-3	49-8			2	0		28-25	540-5	52-2	726-8	52-9
		4	0		26-01	543-2	50-9	739-7	52-3			4	0		26-62	541-5	54-8	724-7	55-0
		6	0		24-60	540-1	50-8	738-0	52-1			6	0		25-73	540-5	53-9	750-3	54-5
		8	0		24-47	541-1	50-2	736-7	52-0			8	0		25-92	533-9	53-6	760-5	54-6
		10	0		24-20	541-0	50-1	735-9	52-0			10	0		24-17	544-4	54-0	736-5	55-2
		18	0	25	24-47	540-1	46-7	742-2	49-0			18	0	25	23-30	540-0	50-1	742-2	52-0
		20	0		23-93	540-5	47-0	735-2	49-0			20	0		23-32	536-2	50-4	744-4	52-0
		22	0		23-26	535-9	46-3	742-6	48-5			22	0		23-46	527-8	49-4	735-7	50-9
Mar.	3	0	0		24-96	534-3	49-0	735-6	50-9	Mar.	10	0	0		27-33	526-5	49-0	725-4	50-5
		2	0		27-71	540-9	52-9	731-0	54-1			2	0		28-17	534-8	50-6	732-1	51-9
		4	0		27-43	543-2	54-9	727-6	56-0			4	0		26-03	540-1	52-3	723-2	53-4
		6	0		25-78	540-6	53-6	727-9	54-6			6	0		24-13	539-6	52-4	733-0	53-5
		8	0		23-54	540-3	51-8	728-3	53-3			8	0		24-74	538-9	51-8	733-3	52-9
		10	0		23-21	537-8	50-2	735-4	52-0			10	0		23-07	537-0	51-7	736-6	53-0
		18	0	25	23-23	534-6	43-0	706-7	45-0			18	0	25	22-92	536-3	48-8	725-9	50-3
		20	0		23-56	539-7	43-6	738-4	45-9			20	0		22-85	538-0	49-4	730-0	50-7
		22	0		23-04	537-9	44-1	740-2	46-5			22	0		23-86	532-1	49-8	725-5	50-6
Mar.	4	0	0		26-48	535-9	47-2	717-4	48-6	Mar.	11	0	0		26-89	531-8	52-2	716-4	53-0
		2	0		29-58	543-0	51-0	702-7	51-6			2	0		29-76	537-8	53-8	711-9	54-4
		4	0		28-70	544-5	53-8	712-2	54-0			4	0		29-66	540-6	56-0	717-9	56-3
		6	0		27-24	545-7	54-6	718-9	54-5			6	0		27-88	537-5	56-3	725-0	56-9
		8	0		27-24	539-0	53-4	747-0	54-0			8	0		21-81	546-3	55-0	725-4	55-9
		10	0		19-81	534-8	52-0	755-4	53-0			10	0		17-69	529-8	54-6	735-5	55-9
Mar.	5	18	0	25	22-96	528-4	45-6	729-4	46-8	Mar.	12	18	0	25	22-25	527-7	49-3	699-5	50-8
		20	0		30-37	537-3	45-8	712-2	47-0			20	0		29-06	516-2	50-2	721-1	52-0
		22	0		24-84	531-0	46-1	725-3	47-3			22	0		25-99	524-1	50-9	726-5	52-5
Mar.	6	0	0		29-19	533-6	49-8	718-7	50-5	Mar.	13	0	0		28-27	525-0	52-9	734-9	54-2
		2	0		29-88	543-1	52-5	719-4	52-5			2	0		29-58	531-8	54-0	731-5	55-0
		4	0		27-26	545-5	56-0	720-6	56-0			4	0		31-23	539-9	53-4	740-0	55-0
		6	0		28-10	535-1	56-1	740-6	56-2			6	0		26-94	539-4	54-9	760-0	57-0
		8	0		25-75	542-3	56-7	760-4	57-2			8	0		21-81	537-5	52-9	739-4	54-5
		10	0		15-23	536-4	55-9	726-1	56-8			10	0		23-77	533-3	51-0	734-3	52-5
		18	0	25	17-61	525-4	55-2	661-6	58-0			18	0	25	21-51	528-7	47-9	695-7	49-7
		20	0		25-90	530-5	56-0	705-4	58-5			20	0		23-41	527-8	47-7	710-4	49-7
		22	0		24-22	527-7	56-4	721-1	58-1			22	0		24-01	525-0	46-9	733-8	49-6
Mar.	7	0	0		30-05	521-5	57-6	739-7	58-8	Mar.	14	0	0		25-58	528-5	51-0	734-3	51-9
		2	0		31-33	536-4	58-2	759-5	59-4			2	0		28-77	535-3	54-8	714-6	55-0
		4	0		39-46	547-4	58-3	803-5	59-5			4	0		26-73	534-6	56-2	724-4	56-5
		6	0		29-80	546-8	57-6	887-8	58-5			6	0		23-86	534-9	55-7	745-3	56-1
		8	0		32-40	513-5	55-5	1028-2	57-4			8	0		22-25	535-3	53-8	724-6	54-7
		10	0		25-83	528-6	54-8	813-1	57-5			10	0		21-73	537-1	52-1	723-6	53-3
		18	0	25	22-92	530-2	46-2	761-4	48-3			18	0	25	22-72	532-1	47-4	730-4	49-1
		20	0		23-73	527-7	45-9	764-4	48-0			20	0		22-02	529-9	46-9	740-2	48-9
		22	0		24-25	523-9	45-6	759-4	47-8			22	0		21-15	530-0	46-7	735-5	48-3
Mar.	8	0	0		27-13	521-7	48-7	744-0	50-0	Mar.	15	0	0		24-48	531-1	49-4	723-0	50-2
		2	0		28-64	532-7	52-6	728-6	53-3			2	0		27-49	535-9	53-9	712-6	54-1
		4	0		26-91	541-2	56-0	723-9	55-9			4	0		24-80	543-2	57-8	707-5	57-5
		6	0		25-49	538-6	57-6	719-2	57-0			6	0		23-03	539-4	57-7	703-9	57-5
		8	0		25-16	538-5	56-6	727-2	56-5			8	0		23-29	534-9	56-1	717-0	56-5
		10	0		24-60	535-8	54-2	736-4	55-0			10	0		23-46	534-8	53-8	714-0	54-5

DECLINATION. Torsion removed, circle reading.—March 10^d 3^h, 36°; 13^d 23^h, 38°.BIFILAR. $k=0-0001248$.BALANCE. $k=0-000015$ approximately.

Göttingen Mean Time of Declination Observation.			DECLINA- TION.		BIFILAR.		BALANCE.		Göttingen Mean Time of Declination Observation.			DECLINA- TION.		BIFILAR.		BALANCE.		
					Cor- rected.	Thermo- meter.	Cor- rected.	Thermo- meter.						Cor- rected.	Thermo- meter.			
Mar. 15	18	0	25	22-18	Se. Div.	°	Mic. Div.	°	Mar. 22	18	0	25	23-14	Se. Div.	°	Mic. Div.	°	
	20	0		20-95		45-1		46-5		20	0		24-60		53-3		682-0	53-8
	22	0		21-01		43-7		710-1		20	0		24-04		53-0		690-0	53-2
Mar. 16	0	0		26-42		43-0		709-4		22	0		24-04		52-2		690-8	52-5
	2	0		28-50		43-2		705-5		0	0		28-07		53-3		689-3	52-5
	4	0		25-43		43-5		709-3		2	0		31-83		53-2		695-9	53-4
	6	0		24-04		43-7		719-1		4	0		29-01		54-0		701-0	54-2
	8	0		21-84		43-6		731-5		6	0		24-87		53-5		724-6	54-5
	10	0		19-83		43-5		730-1		8	0		23-43		53-3		717-9	54-3
						43-4		730-3		10	0		24-10		53-6		702-6	54-0
	18	0	25	21-68		44-7		715-1		18	0	25	23-97		46-8		689-3	47-7
	20	0		20-03		44-9		720-1		20	0		22-96		46-2		705-1	47-0
	22	0		20-57		45-1		720-8		22	0		21-98		46-0		711-2	46-6
Mar. 17	0	0		26-39		45-5		701-1		0	0		27-87		46-3		707-5	46-7
	2	0		27-85		46-2		708-4		2	0		30-27		46-8		703-2	47-0
	4	0		27-26		46-9		717-6		4	0		27-36		46-7		702-7	46-9
	6	0		26-99		47-2		722-6		6	0		24-00		46-1		704-5	46-4
	8	0		25-81		47-0		750-6		8	0		23-93		45-8		702-8	46-0
	10	0		21-24		46-8		746-2		10	0		23-86		45-3		703-5	45-6
	18	0	25	24-17		45-8		702-8		18	0	25	23-26		44-5		698-9	44-8
	20	0		23-26		45-5		710-2		20	0		22-58		44-3		702-5	44-7
	22	0		23-39		45-8		709-3		22	0		21-19		44-3		703-0	44-6
Mar. 18	0	0		31-14		47-2		701-9		0	0		26-59		45-2		694-7	45-2
	2	0		34-26		50-0		701-2		2	0		29-80		47-2		684-6	46-5
	4	0		35-47		53-0		733-2		4	0		27-85		48-1		693-7	47-3
	6	0		13-91		53-7		780-0		6	0		24-60		47-9		699-4	47-0
	8	0		24-82		53-0		748-3		8	0		23-70		46-7		696-8	46-1
	10	0		23-39		51-3		737-0		10	0		23-66		44-8		701-6	45-0
Mar. 19	18	0	25	24-28		44-7		704-2		18	0	25	22-11		37-2		686-4	38-0
	20	0		22-79		44-2		702-8		20	0		21-76		36-7		692-9	37-5
	22	0		23-79		44-4		701-8		22	0		22-33		36-6		694-1	37-3
Mar. 20	0	0		29-46		46-0		697-6		0	0		28-39		36-8		691-0	37-5
	2	0		33-34		48-0		700-7		2	0		30-12		37-0		686-3	37-5
	4	0		31-12		48-1		711-8		4	0		26-72		37-1		699-9	37-7
	6	0		25-41		47-7		721-8		6	0		24-69		37-0		698-4	37-5
	8	0		22-47		46-6		717-8		8	0		24-01		36-7		692-7	37-1
	10	0		19-15		45-7		712-6		10	0		23-86		36-1		693-3	36-8
	18	0	25	22-65		43-7		699-7		18	0	25	21-79		35-4		686-5	36-0
	20	0		23-73		43-8		698-1		20	0		20-32		35-4		689-9	36-0
	22	0		24-00		44-0		701-6		22	0		21-76		35-9		685-7	36-4
Mar. 21	0	0		25-88		46-2		697-3		0	0		26-06		37-9		678-5	37-9
	2	4		30-45		48-7		688-4		2	0		29-44		40-0		681-7	39-5
	4	0		28-74		50-1		700-3		4	0		25-21		42-3		687-2	41-5
	6	0		27-29		50-1		710-2		6	0		23-10		43-4		687-0	42-2
	8	0		24-58		50-9		711-4		8	0		22-99		42-7		682-6	41-9
	10	0		24-22		50-7		707-3		10	0		23-12		40-9		685-0	40-8
	18	0	25	23-32		47-4		690-2		18	0	25	22-27		35-0		677-6	36-1
	20	0		22-72		47-4		694-7		20	0		19-22		34-1		676-3	35-1
	22	0		22-23		47-6		694-0		22	0		19-42		34-1		679-1	35-0
Mar. 22	0	0		30-43		48-4		688-4		0	0		24-20		37-2		661-6	37-3
	2	0		35-67		51-6		685-8		2	0		31-03		41-2		666-5	40-5
	4	0		32-28		54-5		714-5		4	0		32-22		45-1		703-4	44-2
	6	0		25-96		55-5		743-3		6	0		27-38		48-1		725-3	47-3
	8	0		26-22		55-0		723-6		8	0		19-42		47-8		747-5	47-2
	10	0		20-87		56-0		724-4		10	0		6-44		46-7		678-9	46-7

DECLINATION. Torsion removed, circle reading.—March 17^d 3^h, 26°; 20^d 23^h, 21°.
 BIFILAR. $k=0-0001248$. BALANCE. $k=0-000015$ approximately.

March 16^d. The use of the copper stove was discontinued after this during the Daily Observations.
 March 29^d 0^h. The floor of the Observatory being washed.

Göttingen Mean Time of Declination Observation.			DECLINA- TION.	BIFILAR.		BALANCE.		Göttingen Mean Time of Declination Observation.			DECLINA- TION.	BIFILAR.		BALANCE.			
				Cor- rected.	Thermo- meter.	Cor- rected.	Thermo- meter.					Cor- rected.	Thermo- meter.				
d.	h.	m.	°	'	Sec. Div.	°	Mic. Div.	°	d.	h.	m.	°	'	Sec. Div.	°	Mic. Div.	°
Mar. 29	18	0	25	21-93	528.0	39.2	662.5	39.7	Apr. 5	18	0	25	14-23	515.4	45.3	566.9	46.9
	20	0		21.31	526.3	38.0	669.4	38.5					23.63	519.2	44.6	563.5	45.5
	22	0		20.54	518.7	38.0	672.9	38.4					28.64	504.6	44.6	633.5	45.3
Mar. 30	0	0		24.77	521.8	39.6	663.6	40.0	Apr. 6	0	0		34.82	521.1	45.2	701.8	46.6
	2	0		28.55	531.8	42.1	684.3	42.2					41.98	533.5	46.5	746.1	46.5
	4	0		27.76	538.5	43.9	678.9	44.0					40.91	555.1	49.0	804.9	48.5
	6	0		24.67	536.0	45.0	698.6	45.0					32.69	543.4	50.0	803.3	49.2
	8	0		19.33	542.3	45.1	693.7	45.1					26.35	540.3	49.6	726.9	49.0
	10	0		21.37	538.6	45.4	681.1	45.4					8.60	521.8	49.0	735.4	48.6
	18	0	25	21-41	540.5	46.7	662.8	46.8					25 21-68	527.6	46.8	607.8	47.5
	20	0		20.67	533.7	46.6	676.2	46.8					21.91	530.1	45.8	659.3	46.5
	22	0		20.23	525.1	47.3	674.1	47.4					24.65	521.6	46.1	678.2	46.7
Mar. 31	0	0		25.41	527.1	48.8	656.4	48.9	Apr. 7	0	0		29.33	518.5	47.0	675.2	47.2
	2	0		29.15	536.0	50.7	659.0	50.8					32.51	527.0	48.8	692.3	48.4
	4	0		26.77	545.3	52.4	666.6	52.4					32.30	537.7	50.1	708.1	49.5
	6	0		24.80	542.1	52.9	678.1	52.7					20.47	538.8	50.9	765.1	50.0
	8	0		23.79	541.1	52.4	678.3	52.3					19.10	538.7	50.8	743.9	50.1
	10	0		23.93	539.3	51.3	673.5	50.4					18.73	536.4	50.3	694.8	50.6
	18	0	25	22-99	539.5	49.0	668.1	49.2					25 23-90	544.5	43.5	626.0	44.5
	20	0		21.35	537.2	48.9	670.2	49.0					25.38	528.6	42.9	659.9	43.9
	22	0		22.58	525.9	49.1	670.0	49.0					23.59	522.7	43.7	681.1	44.4
Apr. 1	0	0		28.18	525.3	50.2	656.4	50.0	Apr. 8	0	0		28.15	524.1	45.3	683.3	45.4
	2	0		32.40	540.4	52.0	658.8	51.9					30.99	528.4	46.9	696.2	46.5
	4	0		28.55	543.3	52.9	672.6	52.6					29.24	542.9	48.7	716.3	47.7
	6	0		25.19	546.3	53.6	681.5	53.4					16.62	561.0	48.0	773.8	47.5
	8	0		24.00	541.5	53.3	679.6	53.2					20.67	543.2	46.7	756.7	46.5
	10	0		23.93	539.3	52.8	676.3	52.5					22.30	536.7	45.2	716.5	45.5
Apr. 2	18	0	25	19-93	543.9	49.6	649.9	49.5	Apr. 9	18	0	25	20-03	530.5	38.2	655.5	39.2
	20	0		20.55	535.3	49.3	663.0	49.2					23.39	528.5	37.6	668.3	38.5
	22	0		22.85	525.5	50.0	668.4	49.8					24.64	522.0	38.0	679.5	38.6
Apr. 3	0	0		30.34	527.9	51.7	649.7	51.5	Apr. 10	0	0		25.83	520.9	39.2	673.4	39.7
	2	0		35.77	532.2	53.2	661.1	53.3					28.00	529.1	41.2	674.5	41.2
	4	0		29.95	535.8	54.8	685.4	54.8					26.62	533.9	42.6	682.6	42.1
	6	0		26.62	543.6	55.8	690.9	55.5					24.35	539.7	43.3	695.8	42.6
	8	0		25.02	542.5	55.0	683.4	54.6					22.90	540.2	42.2	691.2	42.0
	10	0		20.77	528.1	53.4	679.6	53.0					23.98	539.3	40.8	692.2	41.0
	18	0	25	21-10	534.7	47.5	676.3	47.5					25 22-55	532.4	34.6	679.2	35.5
	20	0		22.69	532.2	47.0	684.4	46.8					20.07	528.9	34.2	689.5	35.0
	22	0		23.27	523.9	46.9	675.9	46.6					24.67	518.9	34.8	697.3	35.5
Apr. 4	0	0		29.85	521.8	47.4	660.9	47.2	Apr. 11	0	0		29.04	526.6	36.4	678.2	36.6
	2	0		34.09	533.4	48.0	650.5	47.8					29.46	536.0	38.7	676.3	38.4
	4	0		29.58	538.2	48.8	674.2	48.5					26.42	539.3	41.0	687.6	40.5
	6	0		25.95	539.2	48.9	686.3	48.5					24.08	547.2	41.6	688.9	41.0
	8	0		24.53	542.9	48.6	687.4	48.4					16.10	527.4	40.8	714.5	40.5
	10	0		21.91	538.6	48.0	680.8	47.9					22.45	535.4	39.3	706.6	39.6
	18	0	25	20-77	543.2	46.2	660.0	46.2					25 22-45	538.3	33.7	682.3	34.8
	20	0		21.49	543.0	45.9	665.5	46.0					20.84	533.9	33.2	682.0	34.3
	22	0		23.93	533.6	46.0	666.3	46.0					23.19	521.5	34.3	690.7	35.0
Apr. 5	0	0		28.42	527.1	46.8	650.3	46.8	Apr. 12	0	0		27.96	527.6	36.5	677.8	36.6
	2	0		36.06	549.5	47.7	657.7	47.4					29.88	542.5	39.1	677.1	38.1
	4	0		31.55	555.9	48.3	737.7	48.3					28.07	559.5	42.1	690.1	41.5
	6	0		23.56	592.1	49.8	1065.6	49.4					29.01	534.4	42.8	786.5	42.2
	8	0		16.57	509.4	50.2	897.1	49.8					23.07	537.0	41.9	800.7	41.7
	10	0		20.47	468.1	49.8	679.5	50.0					18.55	542.2	40.7	712.5	41.5

DECLINATION. Torsion removed, circle reading.—March 31^d 3^h, 14°; April 3^d 23^h, 18°; 10^d 23^h, 22°.
 BIFILAR. $k=0.0001248$. BALANCE. $k=0.000015$ approximately.

April 3^d. Workmen making and laying carpets in the Observatory, at intervals, since March 29^d.

Göttingen Mean Time of Declination Observation.			DECLINA- TION.		BIFILAR.		BALANCE.		Göttingen Mean Time of Declination Observation.			DECLINA- TION.		BIFILAR.		BALANCE.	
					Cor- rected.	Thermo- meter.	Cor- rected.	Thermo- meter.						Cor- rected.	Thermo- meter.		
d.	h.	m.	°	'	Sc. Div.	°	Mic. Div.	°	d.	h.	m.	°	'	Sc. Div.	°	Mic. Div.	°
Apr. 12	18	0	25	23-26	524.4	35.3	637.9	36.2	Apr. 19	18	0	25	21-24	533.9	53.8	677.7	54.5
	20	0		21-35	532.5	35.3	669.5	36.1		20	0		18-59	538.5	52.2	675.7	52.8
	22	0		23-10	523.6	36.3	691.6	36.9		22	0		19-71	530.6	52.7	680.4	53.0
Apr. 13	0	0		28-94	523.3	38.6	685.2	38.6	Apr. 20	0	0		25-52	527.4	54.8	684.3	54.8
	2	0		30-65	539.7	40.9	680.5	40.5		2	0		28-81	534.2	56.1	669.7	55.6
	4	0		29-78	539.7	42.6	703.8	41.9		4	0		25-41	540.7	56.3	691.6	56.0
	6	0		25-04	542.3	42.4	719.9	42.0		6	0		22-49	545.5	56.0	696.6	55.7
	8	0		23-39	545.1	41.7	696.9	41.5		8	0		21-41	546.3	55.6	700.5	55.5
	10	0		20-43	551.9	40.6	666.9	41.0		10	0		21-34	545.6	55.6	694.7	55.9
	18	0	25	21-71	527.1	38.7	677.2	39.4		18	0	
	20	0		22-50	539.3	40.4	638.0	40.5		20	0	
	22	0		21-84	529.2	43.0	671.4	42.5	Apr. 21	0	0	25	20-10	531.9	51.4	687.7	51.4
Apr. 14	0	0		29-65	519.1	46.8	669.3	45.4		2	0		25-31	530.0	53.7	679.9	53.0
	2	0		32-87	528.3	50.5	663.5	48.6		4	0		30-48	540.7	56.0	670.0	55.0
	4	0		27-43	544.7	53.2	677.4	51.1		6	0		24-71	540.4	57.6	701.2	56.5
	6	0		24-60	552.4	54.7	727.3	52.7		8	0		25-21	546.0	58.3	701.9	57.0
	8	0		21-91	546.9	53.9	730.8	52.5		10	0		24-40	546.3	57.7	687.3	56.7
	10	0		21-58	533.1	52.8	646.0	52.0		18	0	25	21-56	537.4	52.4	689.4	52.5
	18	0		26-10	532.1	49.4	670.1	49.5		20	0		21-15	533.5	52.0	688.4	52.0
	20	0		19-09	530.3	49.0	671.4	49.3	Apr. 22	0	7		21-81	530.5	52.0	683.9	52.0
	22	0		22-77	514.4	50.1	692.4	49.9		2	0		24-33	531.6	52.3	673.3	52.3
Apr. 15	0	0		28-17	523.4	51.7	680.4	51.0		4	0		26-45	533.7	53.3	678.7	53.0
	2	0		30-94	534.8	53.7	685.3	52.6		6	0		26-08	534.7	53.6	674.1	53.0
	4	0		28-30	535.3	54.4	708.9	53.5		8	0		24-77	544.2	53.2	682.1	52.9
	6	0		17-51	549.9	54.0	722.7	53.4		10	0		23-86	544.6	52.7	685.0	52.5
	8	0		23-30	542.0	52.8	710.6	52.4		18	0	25	20-25	534.1	43.0	676.3	44.0
	10	0		20-94	537.8	51.5	704.9	51.5	Apr. 23	18	7		19-29	533.6	42.7	680.4	43.7
Apr. 16	18	0	25	20-65	536.9	46.8	684.3	48.0		20	0		21-84	531.4	43.8	679.5	44.5
	20	0		19-93	533.9	47.8	693.7	48.0	Apr. 24	0	0		26-62	533.2	47.6	661.1	47.0
	22	0		21-82	522.6	49.3	688.7	49.0		2	0		29-11	543.6	52.0	638.0	50.6
Apr. 17	0	0		27-78	524.4	51.9	666.9	51.0		4	0		26-75	547.6	54.5	646.3	52.8
	2	0		31-29	536.8	54.7	660.5	53.3		6	0		23-86	545.1	54.7	662.0	53.3
	4	0		28-65	542.7	57.2	664.1	55.6		8	0		23-16	547.1	53.6	664.0	52.5
	6	0		26-23	555.1	58.6	680.8	57.0		10	0		22-79	545.6	52.0	663.2	51.5
	8	0		21-31	548.9	58.2	680.1	56.5		18	0	25	20-74	540.0	47.6	668.0	47.5
	10	0		23-36	543.3	55.9	677.9	55.2	Apr. 25	0	0		19-12	537.7	46.8	669.8	47.0
	18	0	25	24-50	531.2	49.0?	646.8	50.0?		20	0		22-11	526.9	46.1	666.6	46.4
	20	0		20-70	534.2	48.2	665.0	49.5		22	0		25-68	525.4	45.8	654.6	46.0
Apr. 18	0	0		24-72	519.3	49.8	676.3	49.8	Apr. 26	0	0		29-17	538.0	47.1	655.2	47.1
	2	0		28-95	526.0	51.7	670.3	51.3		2	0		25-79	546.6	50.1	651.0	49.1
	4	0		537.8	54.2	670.7	53.4		4	0		24-17	549.7	52.0	658.9	50.6
	6	0		28-14	550.7	55.7	677.3	54.7		6	0		22-60	549.9	52.0	665.8	50.7
	8	0		25-72	549.8	55.4	739.6	54.6		10	0		21-64	546.8	50.1	666.1	49.6
	10	0		20-57	554.1	54.8	731.9	54.5		18	0	25	23-59	539.3	43.7	663.8	44.5
	18	0	25	20-52	537.8	51.4	681.2	51.4		20	0		18-62	535.9	43.3	670.5	44.1
	20	0		19-84	535.5	51.7	693.3	51.5	Apr. 26	0	0		19-74	525.9	44.0	674.1	44.5
	22	0		21-44	525.2	52.6	689.3	52.3		2	0		25-95	526.7	46.0	664.3	46.0
Apr. 19	0	0		27-53	524.7	55.0	684.1	54.4		4	0		28-42	541.4	48.5	658.1	47.7
	2	0		30-49	532.8	58.4	674.4	57.0		6	0		25-70	549.4	49.0	661.9	48.4
	4	0		27-36	546.5	60.3	678.3	58.8		8	0		23-90	551.1	49.4	667.5	48.9
	6	0		19-93	544.6	61.2	703.2	59.7		10	0		21-91	548.9	48.2	677.9	48.0
	8	0		23-73	546.6	60.2	684.7	59.2					22-58	546.2	46.8	666.3	46.8
	10	0		23-09	543.8	58.7	683.9	58.5									

DECLINATION. Torsion removed, circle reading,—April 17^d 23^b, 26^l°; 24^d 23^b, 32°.
 BIFILAR. $k=0.0001248$. BALANCE. $k=0.000015$ approximately.

April 18^d 2^b. Declination observation not made in order to make observations of the magnetic dip in various azimuths.

Göttingen Mean Time of Declination Observation.			DECLINA- TION.	BIFILAR.		BALANCE.		Göttingen Mean Time of Declination Observation.			DECLINA- TION.	BIFILAR.		BALANCE.			
				Cor- rected.	Thermo- meter.	Cor- rected.	Thermo- meter.					Cor- rected.	Thermo- meter.				
d.	h.	m.	°	'	Sec. Div.	°	Sec. Div.	d.	h.	m.	°	'	Sec. Div.	°	Sec. Div.		
Apr. 26	18	0	25	19-67	537.9	41.9	675.2	42.5	May 3	18	0	25	20-84	499.4	50.3	673.6	50.6
	20	0		17-99	533.8	41.5	677.1	42.3		20	0		20-05	497.5	49.9	667.1	50.0
	22	0		22-13	528.7	42.4	673.4	43.0		22	0		21-78	491.5	50.9	668.3	50.8
Apr. 27	0	0		30-12	531.7	46.0	646.1	45.5	May 4	0	0		27-00	493.1	53.9	644.3	53.0
	2	0		30-07	538.5	48.8	646.0	47.6		2	0		32-28	509.8	56.9	639.1	55.6
	4	0		25-92*	671.1	49.9		4	0		28-27	502.6	59.4	651.8	57.9
	6	0		22-79	688.3	51.5		6	0		25-29	511.6	60.0	664.6	58.6
	8	0		22-58	548.0	53.5	683.6	51.5		8	0		24-31	511.6	59.0	676.7	58.0
	10	0		23-26	547.7	52.0	676.8	50.9		10	0		23-97	507.7	57.6	665.2	57.0
	18	0	25	17-83	541.6	47.8	675.5	47.9		18	0	25	20-43	496.7	51.3	669.7	51.7
	20	0		18-95	536.8	47.2	672.0	47.4		20	0		19-09	493.3	50.1	666.9	50.5
	22	0		22-85	529.6	47.2	665.5	47.3		22	0		21-98	485.6	50.1	671.3	50.4
Apr. 28	0	0		27-43	534.9	47.9	661.1	47.7	May 5	0	0		27-27	490.0	51.4	651.5	51.4
	2	0		29-85	498.1*	48.8	664.4	48.1		2	0		28-84	500.0	52.7	658.2	52.3
	4	0		25-86	503.9	48.3	672.7	48.1		4	0		24-53	509.8	53.3	669.0	52.7
	6	0		22-58	507.0	48.0	682.2	48.0		6	0		24-06	516.2	54.3	672.2	53.3
	8	0		22-18	504.6	48.1	684.4	48.0		8	0		25-05	512.6	53.6	673.7	52.7
	10	0		21-21	503.5	47.3	671.1	47.3		10	0		24-84	508.6	51.7	663.1	51.0
	18	0	25	19-76	497.1	42.5	680.7	43.5		18	0	25	21-28	496.5	47.8	676.8	47.8
	20	0		18-21	489.9	42.6	672.5	43.4		20	0		20-82	494.6	47.3	679.1	47.6
	22	0		21-48	486.1	43.8	661.1	44.1		22	0		21-71	493.1	48.2	657.8	48.4
Apr. 29	0	0		20-70	490.4	47.8	653.4	47.0	May 6	0	0		28-00	497.7	50.8	645.0	50.0
	2	0		29-95	500.9	52.2	654.8	50.5		2	0		29-60	508.6	53.6	640.8	52.4
	4	0		27-20	504.6	54.6	668.4	52.5		4	0		517.8	55.7	641.1	51.4
	6	0		24-17	506.8	55.0	669.8	53.3		6	0		24-96	516.6	55.9	660.2	54.7
	8	0		23-27	508.6	53.4	665.5	52.4		8	0		21-64	518.0	54.7	701.7	53.9
	10	0		22-74	509.4	52.0	663.2	51.5		10	0		4-10	422.7	53.0	400.2	52.7
Apr. 30	18	0	25	19-65	498.3	47.2	669.7	47.6	May 7	18	0	25	21-84	464.3	48.7	636.1	49.0
	20	0		18-82	492.7	46.9	666.9	47.2		20	0		19-56	478.9	48.6	665.3	48.8
	22	0		22-06	489.9	48.0	662.3	48.1		22	0		22-92	461.6	49.4	692.9	49.5
May 1	0	0		28-27	491.5	51.7	659.8	50.6	May 8	0	0		27-20	481.8	50.7	693.0	50.0
	2	0		29-36	502.1	55.4	651.0	54.0		2	0		27-43	484.6	50.8	685.5	50.2
	4	0		25-38	491.2	58.4	664.9	56.4		4	0		24-84	489.5	51.1	692.0	50.5
	6	0		23-46	509.3	59.8	662.9	57.6		6	0		23-30	498.5	52.6	684.0	51.5
	8	0		22-42	513.4	60.0	669.3	58.0		8	0		22-74	509.9	52.9	678.4	51.5
	10	0		19-22	501.2	57.9	667.5	56.5		10	0		22-05	499.2	51.3	674.6	50.5
	18	0	25	19-15	494.4	49.0	667.5	49.5		18	0	25	19-47	481.7	47.7	604.4	47.5
	20	0		19-65	487.5	48.1	672.6	48.5		20	0		19-17	481.6	48.8	645.7	48.5
	22	0		21-42	489.6	48.6	668.7	49.0		22	0		21-98	480.8	50.3	673.7	49.7
May 2	0	0		485.4	51.7	658.2	51.0	May 9	0	0		27-63	476.5	52.8	660.8	51.5
	2	0		497.8	55.1	643.9	53.9		2	0		28-35	492.9	54.3	657.1	53.0
	4	0		26-89	506.6	57.6	657.6	55.9		4	0		25-76	496.4	55.6	688.6	54.3
	6	0		510.7	59.0	663.9	56.6		6	0		22-49	505.1	55.9	695.0	54.6
	8	0		510.3	58.3	667.0	56.5		8	0		20-00	505.0	56.2	716.6	55.0
	10	0		24-74	504.0	55.7	672.0	54.7		10	0		20-57	505.7	54.2	627.0	53.6
	18	0	25	20-63	498.1	48.8	675.8	49.0		18	7	25	17-61	482.3	48.7	654.9	49.0
	20	0		20-57	498.4	48.3	671.7	48.5		20	0		18-80	487.3	48.4	643.0	48.6
	22	0		22-79	489.9	49.1	670.1	49.1		22	0		21-75	486.2	49.3	659.0	49.3
May 3	0	0		26-50	494.1	51.2	655.7	50.5	May 10	0	0		25-92	487.6	51.7	660.7	50.8
	2	0		27-40	504.1	55.3	640.9	53.9		2	0		30-16	514.7	53.9	664.3	52.7
	4	0		25-75	508.4	58.8	644.8	56.5		4	0		26-13	518.1	55.4	696.9	54.0
	6	0		25-02	510.9	60.7	655.9	58.4		6	0		17-69	531.2	56.3	705.6	54.5
	8	0		23-93	511.5	61.4	663.0	59.0		8	0		23-48	512.0	56.3	708.6	54.7
	10	0		23-73	506.0	59.1	661.6	57.5		10	0		26-59	499.5	54.0	680.4	53.0

DECLINATION. Torsion removed, circle reading,—May 1^d 23^h, 36°; 6^d 5^h, 150°†; 10^d 3^h, 155°.
 BIFILAR. $k=0.0001205$ * BALANCE. $k=0.000015$ approximately.

* April 27^d 2^h—6^h. Bifilar magnet adjusted.
 † April 28^d 0^h—2^h. Bifilar magnet again adjusted.
 ‡ Several observations of the Declination not made for the same reason as on April 18^d.
 § May 6^d 4^h. Observations made on the zero of the Declination scale when a fibre of the suspension-thread was broken. The torsion was ultimately eliminated.
 ¶ May 6^d 0^h—13^h. An excessive magnetic disturbance, during which the torsion circle of the Bifilar Magnetometer was turned from 24° 44' to 29° 45'; it was left reading 28° 41'.
 †† May 9^d. The Bifilar magnet has been moving irregularly throughout the day; the reading has often been as high as 512 Sec. Div.

Göttingen Mean Time of Declination Observation.			DECLINA- TION.	BIFILAR.		BALANCE.		Göttingen Mean Time of Declination Observation.			DECLINA- TION.	BIFILAR.		BALANCE.			
				Cor- rected.	Thermo- meter.	Cor- rected.	Thermo- meter.					Cor- rected.	Thermo- meter.				
d.	h.	m.	°	'	Sc. Div.	°	Mic. Div.	°	d.	h.	m.	°	'	Sc. Div.	°	Mic. Div.	°
May 10	18	0	25	22-96	488-2	46-9	668-3	47-2	May 17	18	0	25	21-71	493-9	45-0	655-5	45-5
	20	0		24-50	486-0	46-6	666-5	46-9		20	0		20-16	493-3	44-8	661-7	45-2
	22	0		25-27	484-4	47-3	670-7	47-6		22	0		21-62	485-6	45-8	652-5	46-0
May 11	0	0		22-80	486-9	49-9	659-2	49-0	May 18	0	0		26-48	494-8	47-4	641-6	47-0
	2	0		27-36	503-1	53-9	664-1	52-4		2	0		30-03	498-9	48-8	654-6	48-0
	4	0		25-46	504-0	57-6	675-4	55-5		4	0		26-94	503-8	49-9	660-2	49-0
	6	0		23-76	509-5	59-7	679-8	57-4		6	0		24-74	512-6	50-1	677-3	49-3
	8	0		26-79	512-3	59-8	675-0	58-0		8	0		22-67	513-4	50-4	686-1	49-5
	10	0		20-74	499-9	58-1	675-3	56-8		10	0		24-13	507-4	49-6	671-9	48-9
	18	0	25	20-00	490-4	49-3	675-1	49-9		18	0	25	22-08	497-2	42-7	672-5	43-5
	20	0		17-27	489-2	49-2	683-8	49-5		20	0		20-43	497-3	43-0	685-7	43-9
	22	0		23-21	481-1	50-7	676-4	50-5		22	0		21-96	490-0	44-8	671-5	45-0
May 12	0	0		28-00	482-6	52-8	670-1	52-0	May 19	0	0		26-89	491-0	47-6	649-9	46-9
	2	0		29-95	504-1	54-6	671-3	53-6		2	0		29-75	498-9	49-8	656-5	48-6
	4	0		27-88	501-6	55-5	679-5	54-5		4	0		26-19	506-4	51-6	668-7	50-0
	6	0		26-50	507-1	55-7	686-2	54-9		6	0		24-72	510-1	52-0	673-8	50-6
	8	0		26-55	505-6	55-2	682-6	54-5		8	0		22-36	510-5	52-0	670-7	50-6
	10	0		25-65	502-6	54-7	682-7	54-2		10	0		23-32	506-7	50-3	663-9	49-5
	18	0	25	21-15	503-2	52-9	649-5	52-7		18	0	25	20-00	498-9	46-0	674-3	46-4
	20	0		20-77	494-0	53-0	662-0	52-9		20	0		17-07	496-9	46-8	684-9	46-9
	22	0		22-33	490-2	53-8	672-2	53-2		22	0		21-21	486-8	47-3	678-6	47-2
May 13	0	0		26-35	488-2	55-3	672-4	54-7	May 20	0	0		27-22	486-1	49-0	653-2	48-5
	2	0		27-13	493-4	56-3	665-3	55-6		2	0		28-17	494-6	51-8	655-8	50-4
	4	0		26-50	496-4	57-2	673-2	56-4		4	0		25-98	504-7	51-5	667-0	52-5
	6	0		24-82	504-9	56-9	683-1	56-3		6	0		24-18	514-5	55-6	674-5	53-7
	8	0		24-25	505-5	56-0	694-3	55-6		8	0		22-45	508-1	54-9	671-7	53-5
	10	0		24-53	501-0	55-0	682-4	55-0		10	0		23-29	507-1	52-8	664-4	52-0
May 14	13	0	25	22-05	501-4	52-0	666-9	52-1	May 21	18	0	25	20-57	500-1	46-8	671-3	46-8
	20	0		19-70	497-9	51-8	667-9	51-8		20	0		19-63	495-2	46-7	673-4	46-7
	22	0		20-57	487-8	52-0	668-2	52-0		22	0		21-37	494-9	46-8	649-3	46-8
May 15	0	0		26-69	486-7	52-6	642-4	52-4	May 22	0	0		24-92	497-7	47-0	639-6	47-0
	2	0		32-97	501-4	52-6	639-2	52-4		2	0		26-59	507-5	47-8	645-3	47-5
	4	0		31-90	523-1	52-3	644-5	52-0		4	0		26-94	510-0	48-1	655-0	47-8
	6	0		28-67	519-1	52-0	665-9	51-6		6	0		25-25	512-8	48-3	666-8	48-0
	8	0		23-91	523-9	51-2	701-2	51-0		8	0		24-85	517-2	48-2	664-1	48-0
	10	0		22-58	497-2	50-7	737-2	50-9		10	0		24-47	512-5	47-7	662-6	47-6
	18	0	25	26-99	506-2	48-3	646-0	48-5		18	0	25	17-62	500-9	46-9	654-5	47-0
	20	0		22-52	488-5	48-2	651-9	48-2		20	0		19-07	491-5	46-9	657-2	47-0
	22	0		25-72	480-3	48-3	667-3	48-3		22	0		20-63	489-0	47-6	645-9	47-4
May 16	0	0		28-15	479-2	48-8	667-4	48-8	May 23	0	0		25-34	492-9	48-1	634-9	47-8
	2	0		31-30	493-8	49-0	663-9	48-9		2	0		26-97	504-1	48-9	645-4	48-4
	4	0		24-96	499-7	49-0	710-9	48-8		4	0		25-07	508-6	49-0	661-3	48-5
	6	0		26-42	512-0	48-8	705-3	48-6		6	0		22-35	512-9	49-0	675-6	48-6
	8	0		25-07	508-2	48-6	693-0	48-4		8	0		22-92	511-9	48-9	667-0	48-6
	10	0		22-45	513-0	48-0	684-0	48-0		10	0		23-93	511-5	48-8	662-7	48-5
	18	0	25	21-26	491-9	46-0	667-7	46-2		18	0	25	18-41	504-0	48-0	658-9	48-0
	20	0		20-57	493-8	46-8	678-7	46-8		20	0		18-45	496-5	48-0	660-2	48-0
	22	0		21-73	490-0	47-3	675-4	47-1		22	0		22-53	484-8	48-3	655-9	48-2
May 17	0	0		25-78	487-5	48-4	659-4	48-0	May 24	0	0		29-91	486-8	48-8	639-1	48-5
	2	0		27-80	500-0	49-9	655-5	49-0		2	0		31-46	496-9	49-0	638-9	48-8
	4	0		22-79	509-1	50-8	689-2	49-8		4	0		27-38	504-8	49-9	665-6	49-5
	6	0		24-55	516-6	50-8	684-4	49-8		6	10		22-58	514-0	50-1	671-6	49-5
	8	0		24-57	513-1	49-7	678-7	49-2		8	0		22-67	515-0	49-8	669-1	49-3
	10	0		23-54	500-3	48-4	673-5	48-3		10	0		23-07	512-1	48-9	661-1	48-6

DECLINATION. Torsion removed, circle reading,—May 12^d 23^h, 175°: 15^d 23^h, 198°: 18^d 3^h, 203°.
 BIFILAR. $k=0.0001205$. BALANCE. $k=0.000015$ approximately.

Göttingen Mean Time of Declination Observation.			DECLINA- TION.		BIFILAR.		BALANCE.		Göttingen Mean Time of Declination Observation.			DECLINA- TION.		BIFILAR.		BALANCE.	
					Cor- rected.	Thermo- meter.	Cor- rected.	Thermo- meter.						Cor- rected.	Thermo- meter.		
d.	h.	m.	°	'	Sc. Div.	°	Mic. Div.	°	d.	h.	m.	°	'	Sc. Div.	°	Mic. Div.	°
May 24	18	0	25	18-97	503.9	47.3	667.9	47.5	May 31	18	0	25	22-72	504.1	47.8	672.7	47.8
	20	0		18-52	497.3	47.6	677.6	47.5		20	0		19-09	496.9	47.8	671.2	47.8
	22	0		21-71	490.8	48.3	661.1	48.0		22	0		21-24	481.4	48.2	666.5	48.0
May 25	0	0		29-33	488.8	49.8	625.1	49.2	June 1	0	0		28-21	488.9	49.0	640.3	48.8
	2	0		33-54	499.8	50.8	622.4	50.0		2	0		34-50	500.5	49.7	645.9	49.2
	4	0		29-89	507.6	51.1	649.7	50.4		4	0		31-04	511.3	50.0	656.4	49.4
	6	0		24-60	511.4	51.1	676.8	50.5		6	0		25-66	513.1	50.2	670.4	49.6
	8	0		23-79	510.8	51.3	670.9	50.7		8	0		24-06	514.1	50.2	662.7	49.7
	10	0		24-17	511.5	51.0	664.7	50.5		10	0		25-18	511.9	50.0	665.1	49.6
	18	0	25	19-80	504.7	49.1	665.2	48.9		18	0	25	21-24	508.1	49.0	671.6	49.0
	20	0		19-39	500.8	50.3	663.3	49.8		20	0		19-06	503.8	49.8	670.6	49.5
	22	0		20-54	491.3	52.0	652.0	51.1		22	0		22-45	490.0	51.7	657.1	50.9
May 26	0	0		29-36	496.0	54.2	632.8	53.0	June 2	0	0		30-39	493.7	53.7	625.6	52.5
	2	0		33-94	503.4	56.3	619.5	55.2		2	0		33-94	504.5	56.0	633.0	54.8
	4	0		28-54	513.5	57.7	635.4	56.5		4	0		32-57	505.2	56.3	652.6	55.2
	6	0		25-95	517.7	58.4	655.2	57.1		6	0		26-97	511.5	55.1	679.3	54.5
	8	0		22-45	515.0	57.3	676.6	56.5		8	0		25-39	521.2	53.9	663.7	53.5
	10	0		17-61	473.2	55.9	578.3	55.5		10	0		25-88	518.4	52.8	651.3	52.5
	18	0	25	17-04	504.3	54.4	649.9	54.4		18	0	25	19-36	502.2	49.7	646.4	49.7
	20	0		16-41	490.8	53.8	661.1	54.0		20	0		15-79	493.8	49.4	653.1	49.4
	22	0		20-67	478.5	53.8	656.5	54.0		22	0		34-85	491.8	49.4	629.3	49.4
May 27	0	0		27-76	489.1	54.9	641.3	54.9	June 3	0	0		30-46	495.7	49.9	638.4	49.7
	2	0		29-98	504.5	55.3	644.8	55.4		2	0		33-42	498.5	50.6	641.2	50.0
	4	0		27-43	514.8	55.7	663.4	55.5		4	0		31-50	500.5	50.3	679.7	50.0
	6	0		23-91	514.5	56.6	670.2	56.2		6	0		28-41	508.5	49.8	680.0	49.5
	8	0		22-65	514.1	56.3	671.8	56.0		8	0		25-63	512.8	49.0	695.6	48.9
	10	0		21-96	508.8	55.7	671.4	55.8		10	0		24-20	504.5	48.1	673.5	48.0
May 28	18	0	25	19-22	503.1	45.8	663.5	46.4	June 4	18	0	25	21-56	501.7	46.3	623.6	46.5
	20	0		18-21	495.5	46.1	678.9	46.5		20	0		23-16	492.6	46.1	655.0	46.4
	22	0		19-47	489.5	46.9	659.2	47.0		22	0		26-42	488.6	46.0	656.1	46.2
May 29	0	0		26-62	495.4	49.6	632.6	49.0	June 5	0	0		29-31	487.6	46.0	643.3	46.1
	2	0		30-99	525.2	52.7	619.0	51.5		2	0		27-96	497.2	46.1	649.2	46.1
	4	0		33-38	516.9	54.0	642.1	52.7		4	0		27-58	516.6	46.1	657.7	46.2
	6	0		27-96	522.6	53.9	660.6	53.0		6	0		24-67	505.8	46.0	675.7	46.0
	8	0		24-24	523.9	53.7	677.2	52.9		8	0		26-01	512.4	45.6	671.5	45.6
	10	0		24-72	510.2	52.7	667.2	52.1		10	0		25-68	505.4	45.1	672.2	45.1
	18	0	25	28-67	509.6	46.8	615.9	47.2		18	0	25	20-41	497.7	44.2	645.8	44.5
	20	0		24-53	493.3	46.8	646.0	47.2		20	0		21-95	496.1	44.9	665.4	45.0
	22	0		21-35	487.7	48.0	651.1	48.0		22	0		23-36	493.5	46.4	649.4	46.0
May 30	0	0		27-02	492.3	50.0	642.1	49.5	June 6	0	0		27-40	492.0	47.8	643.5	47.1
	2	0		30-51	501.8	53.7	643.1	52.4		2	0		29-21	502.0	49.1	636.1	48.3
	4	0		29-31	509.6	55.8	653.9	54.2		4	0		26-97	506.9	50.9	657.7	49.7
	6	0		25-52	512.3	55.0	674.0	54.0		6	0		25-98	508.9	51.6	662.8	50.4
	8	0		24-47	513.3	54.0	674.9	53.3		8	0		25-22	515.2	51.9	660.5	50.9
	10	0		24-67	507.8	52.7	667.3	52.5		10	0		24-60	509.9	51.7	664.7	50.8
	18	0	25	21-14	499.7	48.8	662.8	49.0		18	0	25	21-42	502.9	49.4	642.7	49.4
	20	0		20-63	496.5	48.2	669.3	48.5		20	0		20-30	499.2	50.2	659.4	49.9
	22	0		22-36	486.1	48.0	654.8	48.4		22	0		22-27	490.9	52.0	657.2	51.1
May 31	0	0		26-79	491.3	48.4	632.7	48.5	June 7	0	0		27-76	498.6	53.2	650.3	52.4
	2	0		30-90	506.3	48.9	649.4	49.8		2	0		27-61	511.8	55.4	650.4	54.4
	4	0		28-94	509.7	49.6	658.0	49.2		4	0		29-11	507.7	57.1	657.5	55.9
	6	0		25-46	512.3	49.9	670.4	49.5		6	0		25-01	514.0	57.1	683.7	56.1
	8	0		24-06	513.1	50.0	668.2	49.6		8	0		25-51	518.5	57.0	686.9	56.2
	10	0		23-93	510.5	49.7	666.4	49.4		10	0		32-35	510.1	56.2	642.8	55.8

DECLINATION. Torsion removed, circle reading,—May 26^d 3^h, 229°; * 29^d 3^h, 246°; June 7^d 1^h, 253°.
 BIFILAR. $k=0.0001205$. BALANCE. $k=0.000015$ approximately.

* May 26^d 3^h. Two fibres of the suspension thread of the Declinometer found broken.

Göttingen Mean Time of Declination Observation.			DECLINA- TION.	BIFILAR.		BALANCE.		Göttingen Mean Time of Declination Observation.			DECLINA- TION.	BIFILAR.		BALANCE.	
				Cor- rected.	Thermo- meter.	Cor- rected.	Thermo- meter.					Cor- rected.	Thermo- meter.		
June 7	18	0	25 21-95	484.6	53.7	633.7	53.7	June 14	18	0	25 28-37	494.9	56.3	670.0	56.3
	20	0	25-92	489.1	54.5	642.6	54.3		20	0	23-21	496.3	57.0	677.0	56.6
	22	0	24-60	484.8	55.2	672.8	54.9		22	0	24-72	484.1	57.9	681.2	57.5
June 8	0	0	26-75	494.5	56.0	661.9	55.5	June 15	0	0	31-36	486.2	60.3	664.6	59.5
	2	0	29-68	496.3	56.9	642.0	56.2		2	0	32-60	501.5	63.4	657.9	62.0
	4	0	26-87	504.4	57.8	660.0	57.0		4	0	30-51	505.2	65.7	659.8	64.0
	6	0	25-85	509.8	58.0	668.3	57.3		6	0	27-93	515.2	67.1	672.4	65.1
	8	0	23-19	512.8	57.5	680.5	57.0		8	0	28-64	511.7	67.6	672.1	65.6
	10	0	23-29	504.2	56.2	673.0	56.0		10	0	27-96	507.9	66.1	678.6	65.0
	18	0	25 21-29	496.1	53.1	668.2	53.1		18	0	25 26-13	496.8	57.6	681.7	57.6
	20	0	19-63	492.7	53.4	674.3	53.4		20	0	24-98	488.2	57.3	699.3	57.5
	22	0	22-58	487.7	54.8	670.2	54.4		22	0	24-62	483.8	58.7	677.6	58.5
June 9	0	0	26-35	486.5	55.6	665.6	55.0	June 16	0	0	33-87	488.1	61.7	658.3	60.8
	2	0	28-67	498.8	56.2	659.6	55.5		2	0	498.9	64.9	628.0	63.5
	4	0	26-19	508.3	56.8	666.0	56.1		4	0	29-78	502.9	67.3	656.5	65.5
	6	0	24-75	508.8	57.2	672.6	56.5		6	0	27-44	512.5	68.7	672.5	66.6
	8	0	24-74	509.2	56.7	672.3	56.0		8	0	26-62	512.7	68.3	677.0	66.5
	10	0	23-34	507.7	55.7	675.1	55.5		10	0	27-29	510.3	66.9	681.5	66.9
	18	0	25 17-07	506.1	53.2	666.6	53.2		18	0	25 23-79	502.0	57.7	686.0	58.0
	20	0	19-54	518.7	53.4	655.8	53.4		20	0	24-47	495.5	57.1	690.0	57.4
	22	0	24-06	497.2	54.3	657.5	54.0		22	0	25-81	485.2	57.9	687.8	57.8
June 10	0	0	30-79	491.4	56.0	654.0	55.5	June 17	0	0	32-00	488.6	59.3	669.9	58.6
	2	0	33-27	505.9	58.1	656.3	57.1		2	0	33-22	497.8	61.0	666.6	60.1
	4	0	29-04	511.3	59.7	665.7	58.5		4	0	30-66	505.3	63.2	685.0	61.8
	6	0	25-83	512.3	60.8	681.5	59.5		6	0	27-98	511.6	65.3	679.5	63.4
	8	0	26-17	522.0	61.0	682.2	60.0		8	0	27-93	517.8	66.7	674.6	64.5
	10	0	25-27	514.8	59.3	669.3	58.9		10	0	27-36	507.1	65.0	667.3	63.6
June 11	18	0	25 23-09	501.9	52.7	642.9	52.6	June 18	18	0	25 23-24	500.2	54.0	682.8	54.0
	20	0	23-26	496.9	52.7	655.9	52.5		20	0	21-91	498.3	53.4	683.8	53.4
	22	0	25-19	477.4	52.7	663.7	52.5		22	0	23-86	486.4	53.3	683.8	53.1
June 12	0	0	27-83	492.2	53.5	663.8	53.0	June 19	0	0	24-71	491.9	53.9	666.5	53.6
	2	0	31-19	500.3	54.6	684.9	54.0		2	0	26-22	503.8	54.8	654.4	54.4
	4	0	30-55	505.0	55.6	695.3	54.9		4	8	25-21	506.5	56.0	670.0	55.4
	6	0	25-27	516.1	55.4	708.3	54.8		6	0	21-84	515.0	55.9	674.5	55.3
	8	0	25-88	519.7	54.6	700.3	54.1		8	0	19-22	521.7	55.4	678.1	55.0
	10	0	22-55	508.9	53.4	698.9	53.0		10	0	21-22	514.9	54.8	678.6	54.5
	18	0	25 23-24	490.2	49.9	657.5	49.8		18	0	25 17-09	503.4	51.6	664.4	51.5
	20	0	18-55	485.4	49.8	674.2	49.5		20	0	16-80	497.7	52.0	676.9	51.9
	22	0	22-67	480.3	50.0	684.2	49.8		22	0	17-25	493.8	53.3	674.5	52.7
June 13	0	0	26-62	486.3	51.0	674.8	50.5	June 20	0	0	23-93	497.5	55.9	664.8	54.9
	2	0	32-27	509.9	53.0	663.6	52.3		2	0	28-50	499.0	59.8	636.3	58.0
	4	0	29-31	511.2	54.3	698.2	53.2		4	0	27-22	507.9	63.3	642.9	61.1
	6	0	24-60	492.5	54.8	731.0	54.0		6	0	22-72	521.8	66.3	656.9	63.9
	8	0	26-62	510.4	54.5	695.9	53.8		8	0	21-24	523.7	67.1	662.3	65.1
	10	0	23-57	516.9	53.5	654.2	53.0		10	0	19-33	520.1	65.5	666.2	64.0
	18	0	25 26-15	499.3	50.7	685.3	50.5		18	0	25 17-74	498.9	58.2	665.8	58.5
	20	0	25-11	498.6	51.9	682.3	51.5		20	0	17-14	494.4	58.1	675.4	58.3
	22	0	24-77	492.9	53.4	673.6	52.8		22	0	20-03	489.5	58.5	670.8	58.4
June 14	0	0	30-55	495.4	56.1	658.7	55.1	June 21	0	0	24-13	492.4	59.8	652.1	59.4
	2	0	34-08	503.4	59.2	653.9	57.9		2	0	28-59	504.5	61.3	651.8	60.5
	4	0	32-25	502.7	61.8	668.0	59.8		4	0	26-03	508.1	64.1	658.5	63.0
	6	0	29-51	511.0	63.1	689.2	61.0		6	0	23-04	512.3	66.0	665.7	64.5
	8	0	28-70	512.0	64.0	675.2	62.2		8	0	21-75	516.2	66.7	665.5	65.3
	10	0	27-63	505.9	62.6	671.5	61.5		10	0	20-57	512.8	65.7	668.0	64.8

DECLINATION. Torsion removed, circle reading,—June 8^d 2^h, 267°, 278°; * 16^d 2^h, 118°; † 16^d 3^h, 48°; 18^d 23^d, 77°; 21^d 9^h, 87°.
 BIFILAR. $k=0.0001205$, BALANCE. $k=0.000015$ approximately.

* June 8^d 2^h. When two readings of the torsion circle are given at the same date, the last is the result of a second trial.
 † June 16^d 2^h. Three fibres of the suspension thread of the Declinometer found broken; torsion eliminated as above; the three fibres were then withdrawn, and the torsion again removed before 4^h.

Göttingen Mean Time of Declination Observation.			DECLINA- TION.	BIFILAR.		BALANCE.		Göttingen Mean Time of Declination Observation.			DECLINA- TION.	BIFILAR.		BALANCE.	
d.	h.	m.		Cor- rected.	Thermo- meter.	Cor- rected.	Thermo- meter.	d.	h.	m.		Cor- rected.	Thermo- meter.	Cor- rected.	Thermo- meter.
June 21	18	0	Se. Div. 497.2	59.9	663.7	60.2	June 28	18	0	25 21.24	Se. Div. 507.1	50.8	Mic. Div. 673.9	50.7
	20	0	496.3	59.7	665.7	60.1		20	0	20.43	489.0	50.9	685.9	50.9
	22	0	500.5	61.1	660.0	61.0		22	0	24.06	490.1	51.9	677.7	51.6
June 22	0	0	499.0	63.2	639.0	62.6	June 29	0	0	26.53	497.4	53.7	667.7	53.0
	2	0	504.3	65.8	645.6	65.3?		2	0	28.67	508.4	55.4	659.8	54.6
	4	0	503.7	68.0	643.7	66.9		4	0	25.04	516.4	57.0	674.9	56.0
	6	0	514.5	69.9	651.2	68.4		6	0	21.58	513.5	57.1	675.7	56.2
	8	0	515.3	71.0	657.4	69.3		8	0	19.91	519.4	58.4	671.8	57.7
	10	0	510.3	69.7	657.3	68.4		10	0	20.79	520.2	58.9	662.8	58.0
	18	0	500.0	59.6	655.7	59.6		18	0	25 15.86	505.3	54.3	652.5	54.5
	20	0	492.8	59.0	675.3	59.4		20	0	14.06	495.0	54.3	659.1	54.5
	22	0	486.2	59.4	681.5	59.5		22	0	16.48	490.1	55.3	661.9	55.0
June 23	0	0	25 24.20	487.4	62.0	674.3	61.5	June 30	0	0	33.05	491.7	56.9	650.2	56.4
	2	0	28.57	494.9	66.5	652.3	65.0		2	0	39.66	505.2	59.0	643.6	58.0
	4	0	30.58	504.5	69.9	642.2	68.0		4	0	33.25	522.5	60.4	663.6	59.5
	6	0	29.21	513.8	70.0	648.4	68.2		6	0	31.12	525.5	61.2	704.4	60.1
	8	0	27.83	516.3	69.3	660.5	68.0		8	0	515.7	62.0	712.3	61.0
	10	0	27.49	510.8	67.0	663.3	66.3		10	0	26.08	507.6	61.3	687.7	60.5
	18	0	25 23.66	501.0	59.0	662.5	59.0		18	0	25 25.14	488.8	56.3	582.2	56.4
	20	0	21.24	496.2	59.0	674.9	59.0		20	0	16.40	484.5	57.3	636.9	57.0
	22	0	22.56	490.4	60.3	678.4	60.0		22	0	20.92	481.4	58.4	647.6	58.0
June 24	0	0	32.30	496.0	63.0	666.4	62.1	July 1	0	0	30.07	483.0	59.6	645.6	59.0
	2	0	35.22	501.9	64.9	666.8	63.7		2	0	33.76	491.3	61.6	648.4	60.5
	4	0	31.79	512.3	66.9	646.2	65.3		4	0	30.29	508.7	62.2	659.4	61.3
	6	0	29.22	513.5	68.3	658.9	66.3		6	0	28.64	517.8	62.2	666.5	61.5
	8	0	27.94	513.4	68.8	668.8	66.8		8	0	25.48	520.5	61.9	681.4	61.3
	10	0	27.14	509.9	67.0	676.8	66.0		10	0	25.90	506.6	60.9	669.6	60.5
June 25	18	0	25 21.41	504.4	55.0	661.4	55.0	July 2	18	0	25 24.33	505.7	60.6	633.9	60.5
	20	0	18.46	495.4	54.9	673.0	54.9		20	0	19.58	500.1	60.8	647.7	60.6
	22	0	21.31	483.4	55.1	673.1	55.0		22	0	22.11	484.1	61.3	650.5	61.0
June 26	0	0	31.46	484.4	56.6	647.3	56.0	July 3	0	0	30.79	479.7	62.4	640.8	62.0
	2	0	34.95	504.5	58.9	643.5	57.7		2	0	34.61	492.6	64.1	639.7	63.4
	4	0	33.20	515.7	61.7	675.2	60.0		4	0	32.89	515.3	65.7	656.0	64.6
	6	0	26.62	513.8	63.2	687.4	61.5		6	0	28.88	518.0	66.4	670.9	65.4
	8	0	25.75	517.9	63.0	677.7	61.5		8	0	26.89	517.7	67.0	679.0	66.0
	10	0	25.48	512.0	61.1	669.9	60.3		10	0	19.89	513.0	65.8	660.5	65.0
	18	0	25 20.57	501.9	54.5	672.2	54.9		18	0	25 24.60	492.3	59.2	661.1	59.3
	20	0	19.76	492.3	54.4	676.3	54.6		20	0	22.22	494.7	59.2	680.0	59.4
	22	0	23.12	484.1	54.6	664.0	54.6		22	0	23.59	483.6	59.8	676.8	59.8
June 27	0	0	31.74	486.0	55.1	648.0	55.0	July 4	0	0	28.88	481.0	61.9	668.8	61.3
	2	0	33.55	499.9	56.2	655.6	55.7		2	0	31.19	495.0	64.3	668.9	63.4
	4	0	30.45	510.5	57.8	674.3	57.0		4	0	30.15	510.7	66.6	659.4	65.4
	6	0	25.95	510.1	58.2	677.9	57.2		6	0	28.44	511.8	68.3	662.8	66.6
	8	0	25.31	517.7	57.1	675.5	56.5		8	0	26.15	521.1	69.0	668.0	67.4
	10	0	25.27	513.0	55.7	670.0	55.3		10	0	25.86	512.5	67.6	667.4	67.8
	18	0	25 21.91	504.1	51.0	668.4	51.0		18	0	25 26.84	495.6	61.8	640.2	62.0
	20	0	19.60	497.0	51.2	683.6	51.0		20	0	22.05	498.1	61.4	644.8	61.5
	22	0	23.19	483.9	52.2	674.5	51.9		22	0	24.31	489.3	62.1	666.4	62.1
June 28	0	0	30.96	487.6	53.2	657.1	52.7	July 5	0	0	28.08	487.1	63.6	666.7	63.2
	2	0	32.72	501.1	54.8	658.2	54.0		2	0	29.89	498.9	66.1	662.5	65.3
	4	0	31.19	512.0	55.7	671.3	54.8		4	0	29.17	504.5	68.1	653.2	67.0
	6	0	26.48	511.5	56.0	681.1	55.4		6	0	29.44	508.1	67.9	651.8	66.9
	8	0	25.75	512.9	55.7	670.9	55.0		8	0	26.10	512.6	67.2	655.9	66.5
	10	0	25.54	509.5	54.4	664.9	54.0		10	0	25.12	507.6	65.6	660.8	65.3

DECLINATION. Torsion removed, circle reading,—June 22^d 23^h, 342°; * 23^d 19^h, 326°; 25^d 19^h, 6°, 11°; 28^d 23^h, 16°, 32°; 29^d 23^h, 318°, † 271°; † 30^d 3^h, 326°; † 30^d 7^h, 334°, 325°; † July 5^d 7^h, 15°.

BIFILAR. $k=0.0001205$.

BALANCE. $k=0.000015$ approximately.

* June 22^d—23^d. Suspension thread of Declinometer broken and a new thread substituted. See *Introduction*.
 † June 29^d—30^d. Experiments made on the torsion of the suspension thread. See *Introduction*.

Göttingen Mean Time of Declination Observation.			DECLINA- TION.	BIFILAR.		BALANCE.		Göttingen Mean Time of Declination Observation.			DECLINA- TION.	BIFILAR.		BALANCE.	
				Cor- rected.	Thermo- meter.	Cor- rected.	Thermo- meter.					Cor- rected.	Thermo- meter.		
July 5	d. 18	m. 0	25 22-83	Se. Div. 499.6	° 62.0	Mic. Div. 662.3	° 62.0	July 12	d. 18	m. 0	25 18-84	S. Div. 498.1	° 59.0	Mic. Div. 659.0	° 59.0
	20	0	22-62	495.7	61.7	660.8	61.8		20	0	19-22	492.4	59.3	658.1	59.3
	22	0	19-86	491.6	62.2	669.5	62.2		22	0	21-81	486.5	60.8	657.5	60.5
July 6	0	0	23-90	487.1	63.3	642.3	63.0	July 13	0	0	28-48	487.9	62.7	663.3	62.0
	2	0	27-49	494.9	65.3	639.1	64.5		2	0	31-19	504.6	65.0	612.1	64.0
	4	0	26-06	503.7	67.2	644.8	66.2		4	0	26-69	516.6	67.7	638.4	66.0
	6	0	24-60	505.1	67.6	652.6	66.7		6	0	23-93	520.0	68.8	654.3	67.1
	8	0	24-53	509.3	67.0	658.1	66.5		8	0	25-95	513.3	69.6	662.4	67.8
	10	0	24-06	509.8	65.8	656.3	65.5		10	0	22-16	507.7	68.0	656.6	67.0
	18	0	25 20-81	496.9	58.7	663.0	58.9		18	15	25 17-31	495.8	60.5	605.1	60.5
	20	0	20-13	492.6	58.1	675.1	58.5		20	0	17-79	493.3	60.2	634.5	60.4
	22	0	21-24	488.2	59.4	679.2	59.4		22	0	18-72	484.9	61.1	655.4	61.0
July 7	0	0	24-01	489.3	61.6	662.9	61.0	July 14	0	0	26-32	492.9	64.0	654.3	63.4
	2	0	26-40	505.5	64.0	648.9	63.0		2	0	25-31	510.2	66.2	650.4	65.2
	4	0	27-26	513.4	66.6	662.2	65.2		4	15	26-86	507.1	67.8	653.2	66.6
	6	0	26-28	517.0	67.0	671.1	65.8		6	0	25-27	514.4	68.6	647.8	67.5
	8	0	25-83	517.5	66.5	682.2	65.5		8	0	23-03	512.0	68.9	663.2	67.6
	10	0	19-09	510.2	65.2	660.4	64.8		10	0	19-53	506.6	67.6	659.4	66.7
	18	0	25 27-85	501.7	59.5	622.5	59.7		18	0	25 18-86	502.7	62.4	653.0	62.3
	20	0	27-49	500.0	59.9	629.5	60.0		20	0	21-84	499.3	62.3	656.4	62.3
	22	0	24-04	473.0	61.2	654.1	60.9		22	0	21-24	493.0	63.8	657.2	63.4
July 8	0	0	27-91	484.3	63.4	658.5	62.7	July 15	0	0	25-81	497.6	65.9	645.5	65.0
	2	0	34-95	488.4	65.3	668.2	64.4		2	0	30-56	500.9	67.6	645.7	66.5
	4	0	31-35	514.8	64.9	672.8	64.0		4	0	26-42	512.1	69.6	635.5	68.0
	6	0	25-88	511.0	64.9	727.5	64.1		6	0	24-58	516.5	71.0	634.3	68.4
	8	0	23-90	513.9	64.7	690.6	64.0		8	0	23-79	512.8	71.0	654.6	69.5
	10	0	23-39	502.1	63.6	658.9	63.4		10	0	22-65	507.7	68.1	642.9	67.5
July 9	18	0	25 20-81	504.7	60.9	636.6	61.0	July 16	18	0	25 19-44	499.9	58.2	651.1	58.5
	20	0	26-62	492.7	61.0	639.9	61.0		20	0	19-12	499.8	57.7	644.8	58.0
	22	0	25-43	483.4	62.0	654.3	62.0		22	0	23-23	496.7	57.9	637.7	58.0
July 10	0	0	28-10	498.9	64.4	653.8	63.6	July 17	0	0	25-29	493.3	59.7	640.6	59.2
	2	0	35-13	486.7	66.2	673.2	65.3		2	0	28-94	490.0	61.6	648.1	60.7
	4	0	27-16	506.2	67.7	678.6	66.4		4	0	29-38	505.3	62.2	646.0	61.5
	6	0	24-40	528.2	68.6	695.1	67.0		6	12	24-47	516.3	62.7	657.4	62.0
	8	0	23-68	510.0	67.7	694.3	66.6		8	0	22-02	512.6	62.6	668.9	62.0
	10	0	25-16	507.2	65.9	662.2	65.4		10	0	22-63	506.4	62.2	662.0	62.0
	18	0	25 18-99	494.8	60.8	657.4	60.9		18	0	25 17-24	500.7	60.7	649.3	60.5
	20	0	20-40	487.6	61.2	664.8	61.1		20	0	16-53	497.9	60.7	653.2	60.5
	22	0	25-21	484.1	62.0	652.0	62.0		22	0	17-61	490.1	60.7	654.6	60.5
July 11	0	0	29-24	492.9	63.6	653.4	63.0	July 18	0	0	24-13	484.5	60.4	634.0	60.3
	2	0	27-17	507.8	65.7	667.6	64.8		2	0	27-40	500.5	61.7	636.7	61.2
	4	0	26-57	512.6	67.9	656.7	66.5		4	0	25-79	509.6	63.3	641.1	62.6
	6	0	25-93	512.1	69.0	655.4	67.3		6	0	23-59	513.0	65.0	649.4	64.0
	8	0	24-60	511.9	69.9	662.7	68.0		8	0	23-93	511.4	65.9	659.5	64.8
	10	0	24-40	510.1	68.4	663.6	67.0		10	0	23-19	508.1	65.0	651.6	64.0
	18	0	25 21-37	496.9	59.3	661.4	59.6		18	0	25 21-04	502.8	58.2	644.7	58.4
	20	0	21-84	490.0	59.1	664.4	59.4		20	0	19-33	502.2	58.4	647.7	58.5
	22	0	22-06	481.3	60.4	673.1	60.3		22	0	20-94	499.0	58.3	630.4	58.5
July 12	0	0	27-80	485.0	62.0	665.4	61.5	July 19	0	0	25-16	489.7	58.7	628.7	58.6
	2	0	29-29	500.7	63.6	660.7	62.8		2	0	29-24	495.2	60.2	629.5	59.8
	4	0	25-27	507.8	64.2	663.7	63.5		4	0	29-12	507.3	61.8	639.3	61.0
	6	0	23-26	510.3	63.3	664.8	63.0		6	0	24-53	513.5	62.3	650.4	61.5
	8	0	21-84	515.5	62.0	675.0	62.0		8	0	22-82	515.7	61.8	649.6	61.0
	10	0	23-26	507.6	61.4	663.6	61.5		10	0	20-88	506.9	60.4	654.6	60.2

DECLINATION. Torsion removed, circle reading,—July 5^d 21^h, 28°; 11^d 3^h, 46°; 51°; 13^d 23^h, 59°; 18^d 19^h, 44°; 19^d 7^h, 67°.
 BIFILAR. $k=0.0001205$. BALANCE. $k=0.000015$ approximately.

Göttingen Mean Time of Declination Observation.			DECLINA- TION.		BIFILAR.		BALANCE.		Göttingen Mean Time of Declination Observation.			DECLINA- TION.		BIFILAR.		BALANCE.	
					Cor- rected.	Thermo- meter.	Cor- rected.	Thermo- meter.						Cor- rected.	Thermo- meter.	Cor- rected.	Thermo- meter.
d.	h.	m.	°	'	Sc. Div.	°	Mic. Div.	°	d.	h.	m.	°	'	Sc. Div.	°	Mic. Div.	°
July 19	18	0	25	18-48	500.9	58.2	647.1	58.8	July 26	18	0	25	18-35	487.1	59.8	624.2	60.0
	20	0		17-88	495.7	57.4	651.3	58.0		20	0		19-02	489.9	59.7	611.1	60.0
	22	0		20-72	490.7	57.4	652.0	57.8		22	0		21-44	484.0	60.6	612.2	60.5
July 20	0	0		25-27	488.8	57.3	642.5	57.5	July 27	0	0		28-65	488.8	62.6	595.0	60.8
	2	0		27-46	497.0	57.3	640.8	57.5		2	0		31-30	505.3	64.9	627.7	64.0
	4	0		23-76	507.5	57.7	649.5	57.8		4	0		26-94	506.1	66.3	642.5	65.4
	6	0		21-96	509.7	58.0	658.3	58.0		6	40		19-67	512.2	66.4	666.4	65.5
	8	0		22-43	510.3	58.2	655.4	58.2		8	0		23-98	505.7	65.6	649.7	65.0
	10	0		22-05	509.4	57.9	651.8	58.0		10	0		24-33	508.6	64.0	641.0	63.9
	18	0	25	19-31	506.0	55.3	641.7	55.5		18	0	25	15-52	496.8	58.8	613.9	59.0
	20	0		19-89	505.7	55.7	641.6	55.7		20	9		20-37	494.3	58.7	624.4	58.7
	22	0		20-43	496.4	56.9	628.9	56.5		22	0		22-69	486.8	59.3	640.1	59.3
July 21	0	0		25-52	492.3	58.1	618.0	57.5	July 28	0	0		25-34	492.9	60.8	618.4	60.4
	2	0		29-31	500.4	59.3	617.2	58.6		2	0		27-36	488.5	62.7	630.1	61.9
	4	0		28-17	511.2	61.2	631.1	60.3		4	0		26-80	501.3	62.9	645.0	62.2
	6	0		23-93	513.9	62.7	637.3	61.5		6	0		23-39	507.6	62.0	640.5	61.6
	8	0		23-86	515.5	63.3	649.7	62.0		8	0		22-16	510.3	61.0	629.3	61.0
	10	0		23-17	509.2	62.0	647.5	61.0		10	0		21-53	505.4	60.0	641.0	60.3
	18	0	25	17-41	503.7	55.1	632.5	55.5		18	0	25	17-94	496.1	57.5	636.7	57.5
	20	0		17-58	497.0	55.1	644.0	55.5		20	0		17-22	498.2	57.9	639.8	57.8
	22	0		20-48	494.8	56.7	640.2	56.4		22	0		21-10	490.2	59.1	635.6	58.9
July 22	0	0		26-67	497.4	58.8	631.2	58.0	July 29	0	0		28-23	483.3	61.2	622.6	60.5
	2	0		29-02	497.9	61.0	632.3	59.8		2	0		32-08	501.7	63.7	624.8	62.6
	4	0		28-05	506.5	61.6	654.4	60.7		4	0		27-70	507.2	64.4	642.8	63.5
	6	0		24-64	510.3	61.7	665.1	61.5		6	0		22-85	517.9	63.6	650.9	63.0
	8	0		23-19	512.3	61.8	658.6	61.2		8	0		17-99	521.1	62.6	671.3	62.5
	10	0		22-92	509.9	61.0	661.2	60.7		10	0		20-20	507.3	61.3	648.2	61.4
July 23	18	0	25	20-61	503.4	54.0	639.1	53.6	July 30	18	0	25	24-72	496.1	58.4	595.2	58.5
	20	0		25 19-15	499.7	54.2	654.4	53.9		20	0		19-63	493.8	58.4	631.7	58.5
	22	0		25 21-64	495.9	55.0	649.2	54.7		22	0		21-95	485.2	58.9	640.0	58.8
July 24	0	0	25	26-52	499.2	56.3	629.3	56.0	July 31	0	0		26-19	484.4	60.0	622.3	59.6
	2	0		25 27-96	511.7	57.9	633.2	57.0		2	0		28-48	503.9	60.8	622.8	61.6
	4	0		25 25-79	513.5	60.0	637.1	59.0		4	0		510.7	64.2	643.2	64.2
	6	0		25 25-32	567.3	61.3	621.0	60.2		6	0		513.3	65.6	650.2	64.4
	8	0		25 22-99	524.7	62.1	685.1	61.0		8	0		20-10	513.1	64.8	657.2	64.0
	10	0	24	55-11	507.9	61.3	593.6	60.5		10	0		17-34	510.9	62.8	639.4	62.6
	18	0	25	17-88	503.1	54.8	654.6	54.7		18	0	25	18-08	498.6	58.3	640.9	58.5
	20	0		17-67	496.7	54.2	654.9	54.6		20	0		17-44	494.5	58.0	640.2	58.2
	22	0		31-03	444.1	56.3	674.9	56.0		22	0		18-87	491.3	58.0	643.5	58.0
July 25	0	0		33-15	467.2	60.0	702.6	59.6	Aug. 1	0	0		24-96	488.7	58.7	623.6	58.5
	2	0		35-59	517.5	63.2	814.0	63.2		2	0		28-44	505.6	60.2	620.1	59.7
	4	0		28-12	609.2	65.0	905.5	63.7		4	0		28-32	515.7	61.3	625.9	60.5
	6	0		31-96	519.4	66.0	812.8	64.9		6	0		23-48	510.7	61.4	629.7	60.8
	8	0		19-63	508.0	65.8	736.0	65.0		8	0		21-91	511.5	61.1	636.6	60.7
	10	0		20-10	474.3	64.6	663.7	64.0		10	0		20-58	509.7	60.3	635.2	60.2
	18	0	25	15-03	466.0	60.8	642.9	60.9		18	0	25	19-51	498.6	58.0	638.2	58.0
	20	0		20-70	486.3	60.9	646.2	60.9		20	0		16-35	495.8	57.9	637.3	57.9
	22	0		22-72	479.5	61.6	644.8	61.4		22	0		19-93	489.9	58.1	641.3	58.0
July 26	0	0		26-97	481.5	63.7	630.0	63.0	Aug. 2	0	0		27-31	490.1	58.9	617.5	58.6
	2	0		29-91	499.3	65.4	622.1	64.5		2	0		28-30	494.6	60.0	610.6	59.5
	4	0		29-31	508.7	66.3	632.2	65.4		4	0		25-01	500.9	60.8	630.9	60.1
	6	0		24-60	508.1	66.4	662.9	65.6		6	0		21-91	512.6	61.9	643.6	61.1
	8	0		23-50	508.4	66.1	666.4	65.5		8	0		21-04	513.2	62.2	634.4	61.5
	10	0		22-94	505.0	65.2	657.8	65.0		10	0		22-33	509.6	61.3	634.5	60.9

DECLINATION. Torsion removed, circle reading,—July 26^d 7^h, 40°; 30^d 23^h, 25°; 31^d 7^h, 52°.*
 BIFILAR. $k=0.0001205$. BALANCE. $k=0.000015$ approximately.

*July 31^d 2^h. Observations made to determine the zero point of the Declination scale.

Göttingen Mean Time of Declination Observation.			DECLINA- TION.		BIFILAR.		BALANCE.		Göttingen Mean Time of Declination Observation.			DECLINA- TION.		BIFILAR.		BALANCE.	
					Cor- rected.	Thermo- meter.	Cor- rected.	Thermo- meter.						Cor- rected.	Thermo- meter.	Cor- rected.	Thermo- meter.
d.	h.	m.	°	'	Sc. Div.	°	Mic. Div.	°	d.	h.	m.	°	'	Sc. Div.	°	Mic. Div.	°
Aug. 2	18	0	25	19.80	502.9	58.0	638.0	58.0	Aug. 9	18	0	25	18.63	499.6	59.5	631.7	59.5
				17.41	497.5	58.0	644.7	58.0					18.68	488.4	58.7	646.2	58.8
				20.97	493.1	59.7	635.7	59.0					20.10	479.4	59.0	645.3	59.2
Aug. 3	0	0		26.89	488.6	61.4	619.6	60.7	Aug. 10	0	0		28.27	490.7	61.6	607.0	61.0
				29.29	507.1	64.0	610.1	63.0					28.64	507.4	65.3	624.4	64.1
				29.08	535.3	66.7	604.0	65.2					25.02	512.0	67.8	637.6	66.0
				21.08	512.7	68.0	637.0	66.5					22.53	522.7	69.2	641.3	67.2
				21.79	526.7	67.3	617.9	66.0					21.58	509.7	69.0	628.6	67.0
				16.67	527.2	65.2	625.7	64.7					22.74	508.5	67.0	621.3	65.8
				17.78	497.4	59.4	602.5	59.5					18.55	501.7	59.0	636.1	59.3
				20.27	497.1	59.0	621.0	59.2					17.67	490.8	58.8	641.1	58.8
				20.82	466.7	60.4	625.5	60.2					22.60	483.3	59.6	637.6	59.5
Aug. 4	0	0		31.43	490.3	62.8	601.8	62.2	Aug. 11	0	0		27.50	485.6	62.1	626.2	61.5
				29.42	512.9	65.0	682.0	64.0					30.63	501.5	64.7	626.3	63.5
				32.78	519.3	66.0	685.9	65.0					24.18	499.6	65.7	661.8	64.6
				13.68	537.3	67.0	772.5	66.5					22.57	513.5	66.6	653.3	65.5
				21.24	517.4	66.2	679.1	65.4					19.87	512.7	66.3	648.0	65.5
				20.61	511.5	64.9	624.7	64.4					20.62	524.8	65.1	617.5	64.7
				18.82	492.3	58.8	643.9	59.0					20.17	497.8	59.4	630.0	59.7
				19.22	484.0	58.4	643.3	58.7					20.43	497.3	59.1	636.9	59.5
				23.06	487.3	59.2	630.4	59.2					23.30	487.0	60.0	634.8	60.0
Aug. 5	0	0		24.71	499.7	61.3	623.7	60.9	Aug. 12	0	0		27.60	485.7	62.9	623.4	62.3
				25.98	503.1	63.1	646.0	62.4					33.00	515.5	67.0	621.0	65.6
				23.24	509.5	64.4	628.8	63.5					23.32	512.2	70.0	634.2	68.3
				23.39	516.4	64.2	615.9	63.5					20.47	514.4	71.9	628.2	70.0
				19.40	516.0	63.2	647.9	63.0					17.49	507.7	69.7	635.5	68.5
				22.50	506.3	61.9	633.1	61.8					20.62	507.5	69.1	628.9	68.3
Aug. 6	18	0	25	20.37	499.4	56.9	612.5	57.1	Aug. 13	18	0	25	18.37	494.0	61.7	632.8	62.3
				18.65	494.4	56.6	615.9	56.7					17.62	489.0	61.0	641.7	61.4
				21.61	490.6	57.5	620.7	57.4					19.87	486.0	61.7	652.7	61.9
Aug. 7	0	0		23.90	497.3	59.0	606.4	58.5	Aug. 14	0	0		27.54	485.7	64.1	630.6	63.6
				26.80	501.9	60.6	610.1	59.7					30.65	508.4	68.0	642.3	66.5
				24.38	507.2	61.0	619.6	60.2					28.00	508.8	70.4	648.2	67.6
				23.66	514.9	61.0	630.4	60.4					25.78	509.2	69.4	657.7	67.4
				17.34	519.7	61.0	636.0	60.5					23.21	514.7	68.0	663.8	67.2
				22.67	510.3	61.2	622.0	60.6					20.60	503.4	66.2	618.6	65.7
				17.98	497.9	60.8	576.1	60.5					20.41	498.1	60.0	652.0	60.3
				17.17	494.8	60.7	609.9	60.5					19.24	493.8	60.0	651.7	60.0
				21.05	486.2	61.3	609.7	61.0					23.93	489.5	60.7	638.9	60.6
Aug. 8	0	7		26.06	489.1	62.5	590.0	61.9	Aug. 15	0	0		29.26	490.0	61.2	627.3	61.0
				30.12	497.3	63.4	604.3	63.5					30.22	499.4	62.4	641.7	62.0
				26.72	511.8	65.7	624.5	64.6					26.64	505.2	64.0	654.4	63.2
				22.43	503.7	66.4	647.4	65.5					23.79	508.5	64.6	655.8	63.7
				16.65	512.1	65.9	665.8	65.1					22.63	507.5	64.3	643.0	63.5
				19.47	507.1	64.0	622.1	63.9					22.09	512.1	63.6	635.1	63.1
				37.51	461.8	60.6	475.2	60.7					19.34	502.4	61.6	640.9	61.5
				19.49	498.1	60.4	537.5	60.5					20.65	495.7	61.3	645.5	61.3
				21.95	478.8	61.0	605.6	61.0					22.92	492.4	61.7	641.6	61.5
Aug. 9	0	0		25.88	492.8	63.3	585.2	62.8	Aug. 16	0	0		26.96	492.0	63.0	631.8	62.5
				31.04	496.6	66.4	613.8	65.4					27.53	504.6	65.2	632.2	64.2
				26.08	515.4	69.6	619.5	67.8					26.43	511.2	68.9	633.4	67.1
				21.01	508.6	70.2	641.8	69.5					21.48	510.0	71.0	643.0	68.0
				20.61	496.4	68.0	644.8	66.5					22.63	511.8	71.1	634.2	69.0
				23.88	506.3	67.0	628.3	66.0					22.79	510.3	69.0	629.7	67.9

DECLINATION. Torsion removed, circle reading,—Aug. 4^d 7^h, 67°; 5^d 3^h, 63°; 10^d 23^h, 69°; 13^d 23^h, 81°.*
 BIFILAR. $k=0.0001205$. BALANCE. $k=0.000015$ approximately.

Aug. 7^d 2^h. Value of the torsion co-efficient determined for the Declinometer suspension thread.

Aug. 11^d 0^h—13^d 22^h. Magnet with short scale placed in the Declinometer, on account of observations for absolute horizontal intensity.

—See Introduction.

* Aug. 12^d 3^h. Declination magnet removed, and the deflection magnet substituted, in order to determine its time of vibration.

Göttingen Mean Time of Declination Observation.			DECLINA- TION.	BIFILAR.		BALANCE.		Göttingen Mean Time of Declination Observation.			DECLINA- TION.	BIFILAR.		BALANCE.	
d.	h.	m.		Cor- rected.	Thermo- meter.	Cor- rected.	Thermo- meter.	d.	h.	m.		Cor- rected.	Thermo- meter.	Cor- rected.	Thermo- meter.
Aug. 16	18	0	25 17-99	502.1	64.3	642.9	64.4	Aug. 23	18	0	25 17-47	499.8	53.9
	20	0	19-06	496.3	63.9	644.3	64.0		20	0	16-91	486.9	52.9
	22	0	22 02	491.3	64.4	640.2	64.4		22	0	19-44	484.0	53.3
Aug. 17	0	0	27-14	493.2	66.7	623.9	65.9	Aug. 24	0	0	24-69	495.4	56.7
	2	0	28-55	508.8	70.6	631.9	69.1		2	0	25-68	510.2	61.6
	4	0	25-34	515.5	72.8	617.2	70.3		4	0	24-52	521.6	65.5
	6	0	23-44	512.4	74.4	633.6	72.8		6	0	21-05	516.7	67.7
	8	0	23-17	513.6	73.8	644.1	72.5		8	0	20-10	511.3	67.4
	10	0	21-78	509.4	72.3	638.5	71.6		10	0	21-34	510.2	65.2	812.6	64.6
	18	0	25 19-56	502.2	65.0	638.2	64.5		18	0	25 19-00	503.5	58.7	800.6	58.9
	20	0	20-07	499.3	64.0	650.9	64.5		20	0	18-53	491.5	58.0	815.4	58.2
	22	0	21-95	492.3	64.3	655.8	64.6		22	0	23-61	481.6	58.7	818.3	58.7
Aug. 18	0	0	25-27	491.2	66.8	649.3	66.3	Aug. 25	0	0	26-89	495.2	60.9	805.4	60.5
	2	0	27-83	506.4	71.0	635.4	69.6		2	0	29-29	503.3	63.9	803.5	63.0
	4	0	26-72	509.0	74.6	639.7	72.8		4	0	25-24	515.1	65.8	817.9	64.5
	6	0	24-60	512.8	75.7	663.6	74.0		6	0	21-29	516.2	65.6	832.0	64.6
	8	0	23-48	509.8	75.0	670.7	73.7		8	0	19-83	508.5	65.0	852.0	64.3
	10	0	23-26	508.9	73.1	665.6	72.5		10	0	21-73	506.4	64.1	815.8	64.0
	18	0	25 20-57	500.8	66.7	658.5	67.0		18	0	25 16-37	494.9	61.0	792.0	61.5
	20	0	19-02	493.1	65.7	671.5	66.0		20	0	16-53	488.3	59.8	804.2	60.4
	22	0	23-09	486.1	65.8	674.3	66.0		22	0	22-08	485.3	60.0	809.3	60.5
Aug. 19	0	0	26-55	491.0	68.8	649.3	68.0	Aug. 26	0	0	28-20	487.9	62.2	811.4	62.3
	2	0	30-79	506.4	72.3	652.3	71.1		2	0	28-01	505.0	64.5	818.0	64.1
	4	0	27-96	511.0	75.6	652.0	74.0		4	0	24-47	505.3	65.0	831.6	64.5
	6	0	24-44	511.6	77.2	661.8	75.5		6	0	21-07	507.6	64.1	828.3	64.0
	8	0	23-26	509.3	76.0	667.7	74.5		8	0	21-31	508.7	63.1	805.8	63.4
	10	0	20-43	503.4	74.0	679.9	73.2		10	0	18-80	509.8	62.0	806.0	62.5
Aug. 20	18	0	25 20-67	499.4	57.3	672.8	58.0	Aug. 27	18	0	25 20-34	503.5	56.7	793.5	57.0
	20	0	18-59	495.7	56.8	680.9	57.0		20	0	19-76	497.3	56.1	801.3	56.5
	22	0	23-19	491.3	57.2	692.8	57.4		22	0	20-07	491.2	56.7	809.8	56.8
Aug. 21	0	0	27-18	498.7	59.0	671.6	58.6	Aug. 28	0	0	25-22	492.8	58.4	791.5	58.1
	2	0	28-87	518.1	60.9	676.9	60.0		2	0	29-93	510.0	59.5	789.7	59.0
	4	0	23-62	512.0	62.0	691.1	61.2		4	0	27-54	511.5	60.3	798.4	59.6
	6	0	21-75	511.0	62.0	682.9	61.3		6	0	23-73	512.8	61.2	810.9	60.5
	8	0	23-93	512.2	61.3	673.5	60.7		8	0	21-66	512.4	61.8	799.9	61.0
	10	0	21-04	509.9	60.1	674.6	60.0		10	0	21-46	510.2	61.7	792.9	61.0
	18	0	25 20-10	507.7	57.8	673.4	57.5		18	0	25 19-60	505.3	59.9	795.6	60.0
	20	0	19-27	504.9	57.7	670.8	57.5		20	0	17-78	496.3	59.0	809.1	59.3
	22	0	25-43	498.5	57.7	666.8	57.5		22	0	20-57	486.7	59.0	798.3	59.0
Aug. 22	0	0	31-76	498.8	58.0	663.3	58.0	Aug. 29	0	0	26-55	490.6	60.6	788.7	60.3
	2	0	33-54	487.4	58.9	675.0	58.5		2	0	30-65	508.9	62.9	792.4	62.2
	4	0	31-22	504.7	59.9	718.9	59.4		4	0	27-11	517.1	65.5	783.6	64.3
	6	0	26-94	519.0	60.3	731.3	59.9		6	0	22-99	524.3	66.2	792.4	65.2
	8	0	26-45	522.5	60.0	741.8	59.5		8	0	21-21	514.0	66.0	786.3	65.0
	10	0	25-21	511.9	59.0	702.6	58.9		10	0	20-70	513.5	63.8	780.2	63.2
	18	0	25 20-74	483.9	53.7	649.7	54.0		18	0	25 18-92	507.3	54.7	798.7	55.2
	20	0	19-60	487.9	53.3	665.4	53.6		20	0	17-27	495.0	53.6	801.5	54.1
	22	0	25-01	483.1	54.6	670.7	54.6		22	0	20-60	492.8	54.1	794.9	54.5
Aug. 23	0	0	24-65	490.3	57.0	Aug. 30	0	0	27-29	496.6	56.8	770.9	56.3
	2	0	28-33	506.6	60.0		2	0	29-39	507.1	59.4	767.2	58.5
	4	0	21-33	518.3	62.8		4	0	23-51	512.1	62.2	778.0	61.0
	6	0	21-41	527.7	64.3		6	0	20-98	517.8	64.3	777.9	62.7
	8	0	18-78	511.9	64.6		8	0	19-12	515.3	64.3	781.3	63.0
	10	0	18-48	524.8	62.7		10	0	19-80	513.3	62.7	778.0	62.0

DECLINATION. Torsion removed, circle reading,—Aug. 20^d 23^h, 86°; 21^d 7^h, 92°; 24^d 7^h, 92°; 30^d 3^h, 98°
 BIFILAR. $k=0.0001205$. BALANCE. $k=0.000014^*$ approximately.

Aug. 14^h—4^h. Magnet with short scale in the Declinometer.
 Aug. 21^d 7^h. Deflection magnet vibrated in the Declinometer box.
 Aug. 23^d 0^h—24^d 0^h. Magnet with short scale inserted in the Declinometer box, and the Balance magnet removed, in order to determine its temperature correction. The Declination and Bifilar readings are corrected for the effect of the Balance.
 * Aug. 24^d 7^h. Balance needle vibrated horizontally in the Declinometer box, and afterwards adjusted.
 Aug. 30^d 4^h—Sept. 12^d 22^h. Magnet with short scale in the Declinometer box, while the magnet with the long scale was used in the Extra Declinometer box for temperature experiments and intensity observations.

Göttingen Mean Time of Declination Observation.			DECLINA- TION.	BIFILAR.		BALANCE.		Göttingen Mean Time of Declination Observation.			DECLINA- TION.	BIFILAR.		BALANCE.	
				Cor- rected.	Thermo- meter.	Cor- rected.	Thermo- meter.					Cor- rected.	Thermo- meter.		
Aug. 30	18	8	25 17.92	510.3	57.6	778.1	57.6	Sept. 6	18	0	25 17.92	505.0	61.8	800.2	62.3
	20	0	16.36	504.2	57.3	789.1	57.4		20	0	17.43	489.3	60.2	839.2	60.7
	22	0	19.74	494.3	57.8	788.3	57.8		22	0	17.45	489.2	60.5	848.7	60.9
Aug. 31	0	0	26.28	493.7	60.3	773.3	59.7	Sept. 7	0	0	24.28	494.8	62.9	834.2	62.6
	2	0	30.35	504.0	64.0	772.5	62.7		2	0	27.07	499.6	66.0	840.1	65.2
	4	0	28.20	510.3	66.9	788.7	65.2		4	0	24.45	510.1	69.9	838.6	68.1
	6	0	25.87	512.0	67.3	804.0	66.0		6	0	19.57	506.3	72.1	839.5	70.5
	8	0	21.45	516.0	66.8	810.7	65.6		8	0	19.87	511.2	71.6	816.1	69.7
	10	0	21.82	516.1	65.5	787.3	65.0		10	0	19.18	509.1	69.6	816.2	68.5
	18	0	25 18.03	506.0	61.3	772.4	61.5		18	0	25 20.17	506.9	59.8	813.8	60.4
	20	0	21.86	504.2	61.1	767.1	61.3		20	0	18.07	496.4	58.6	844.2	59.0
	22	0	21.52	494.8	61.8	775.7	61.6		22	0	18.93	491.3	58.8	862.0	59.0
Sept. 1	0	0	28.59	504.7	63.4	Sept. 8	0	0	25.46	493.9	61.9	847.0	61.5
	2	0	31.89	514.3	65.2		2	0	27.20	495.9	67.0	850.2	65.5
	4	0	27.78	525.1	66.0		4	0	25.12	518.2	71.8	837.1	69.5
	6	0	19.42	491.8	67.0		6	0	21.07	508.7	74.9	860.9	72.4
	8	0	17.60	511.8	66.9		8	0	20.55	507.6	74.0	823.7	72.0
	10	0	17.70	503.5	66.0		10	0	16.18	506.7	71.9	811.0	70.6
	18	0	25 19.14	505.4	62.8		18	0	25 20.92	504.8	63.2	808.0	63.6
	20	0	32.55	478.0	62.7		20	0	18.00	496.0	62.0	826.0	62.5
	22	0	24.41	483.5	63.8		22	0	22.85	482.9	61.9	840.6	62.3
Sept. 2	0	0	26.83	485.6	66.7	Sept. 9	0	0	27.46	490.7	64.3	829.3	64.1
	2	0	28.05	492.4	68.6		2	0	30.33	505.3	68.9	822.3	67.5
	4	0	26.60	503.8	69.2		4	0	23.68	524.0	72.6	868.2	70.9
	6	0	20.36	507.5	69.7		6	0	26.88	504.5	74.4	864.0	72.5
	8	0	20.81	503.6	69.1		8	0	20.40	512.7	73.0	834.3	71.6
	10	0	10.78	516.1	68.1		10	0	13.89	504.1	71.0	823.7	70.0
Sept. 3	18	0	25 18.45	500.3	58.8	Sept. 10	18	0	25 23.66	501.6	63.0	866.2	63.0
	20	0	20.06	495.0	58.3		20	0	23.40	494.7	62.9	869.7	63.0
	22	0	18.60	495.8	58.7		22	0	23.32	491.8	63.2	824.4	63.2
Sept. 4	0	0	23.68	498.0	60.6	Sept. 11	0	10	29.25	495.2	65.0	829.0	64.6
	2	0	24.90	503.4	62.9		2	0	28.83	504.1	66.8	836.8	66.0
	4	0	23.70	514.2	64.9		4	0	24.63	511.8	68.8	834.5	67.5
	6	0	20.10	505.5	66.2		6	0	22.21	507.5	68.9	833.0	67.7
	8	0	19.16	512.0	65.9		8	0	19.63	513.5	67.6	832.9	66.9
	10	0	11.62	486.0	63.8		10	0	16.08	506.5	66.2	823.3	66.0
	18	0	25 21.93	491.5	55.0		18	0	25 22.05	507.9	63.2	822.0	63.5
	20	0	26.36	501.1	54.0		20	0	18.11	505.0	62.9	823.8	63.0
	22	0	22.05	481.7	54.4		22	0	19.59	492.5	62.9	816.0	63.0
Sept. 5	0	0	24.09	496.9	57.0	Sept. 12	0	0	26.62	494.3	63.4	815.2	63.5
	2	0	29.36	497.5	61.6	830.1	60.5		2	0	26.86	500.1	65.0	830.6	64.5
	4	0	26.60	505.5	65.7	854.1	64.0		4	0	25.68	516.0	67.4	845.4	66.3
	6	0	21.82	509.9	67.9	887.5	66.0		6	0	24.11	506.2	69.3	861.9	67.5
	8	0	19.12	507.7	67.6	859.8	66.0		8	0	21.22	514.3	69.0	833.1	67.5
	10	0	17.47	505.5	66.0	800.4	65.1		10	0	19.44	507.5	67.1	812.3	66.5
	18	0	25 17.85	511.0	60.0	813.5	60.3		18	0	25 18.97	501.5	60.1	792.5	60.5
	20	0	22.36	496.4	59.8	817.5	60.0		20	0	17.49	500.2	59.1	819.1	59.5
	22	0	26.56	489.9	60.9	834.1	60.7		22	0	19.72	493.2	59.2	831.0	59.5
Sept. 6	0	0	27.37	499.1	64.0	805.0	63.4	Sept. 13	0	0	23.79	496.5	61.1	824.5	60.9
	2	0	27.03	506.0	67.0	822.2	66.0		2	0	27.56	509.1	64.7	830.2	63.7
	4	0	24.15	504.9	69.3	821.8	68.0		4	12	23.95	511.0	67.9	829.5	66.4
	6	0	20.62	507.1	71.9	816.0	70.0		6	0	20.41	502.6	68.7	842.6	67.0
	8	0	20.10	510.2	71.0	815.0	69.8		8	0	19.13	511.6	67.1	818.9	66.0
	10	0	13.08	518.4	69.4	811.0	68.5		10	0	13.82	511.6	64.2	813.7	64.0

DECLINATION. Torsion removed, circle reading.—Sept. 4^d 1^h, 53^m*; 12^d 23^h, 82^m.
 BIFILAR. $k=0.0001205$. BALANCE. $k=0.000013$ * approximately.

* Sept. 1^d—5^d. The Balance magnet removed in order to determine its temperature correction: at 4^d 1^h it was vibrated horizontally in the Declinometer box, and afterwards re-adjusted.

Göttingen Mean Time of Declination Observation.			DECLINA- TION.	BIFILAR.		BALANCE.		Göttingen Mean Time of Declination Observation.			DECLINA- TION.	BIFILAR.		BALANCE.	
				Cor- rected.	Thermo- meter.	Cor- rected.	Thermo- meter.					Cor- rected.	Thermo- meter.		
Sept. 13	18 0	25	19-26	504.3	55.2	832.7	55.9	Sept. 20	18 0	25	20-41	503.0	64.7	777.1	65.0
	20 0		17-42	508.8	54.8	843.0	55.2		20 0		15-17	505.4	64.0	787.7	64.4
	22 0		19-94	501.5	55.2	861.0	55.5		22 0		18-62	492.8	64.0	801.8	64.5
Sept. 14	0 0		22-90	502.6	57.9	842.5	57.4	Sept. 21	0 0		23-09	496.7	65.4	805.3	65.4
	2 0		26-17	511.3	61.3	825.0	60.0		2 0		26-32	500.0	67.3	799.6	67.0
	4 0		23-79	511.4	64.7	827.0	63.0		4 0		26-45	512.1	69.7	799.2	68.4
	6 0		20-37	516.1	65.9	831.5	64.0		6 0		22-43	506.3	70.8	828.9	69.5
	8 0		15-83	510.7	64.9	842.5	63.6		8 0		8-46	505.1	68.9	829.1	68.0
	10 0		17-81	512.1	63.6	830.3	63.0		10 0		18-75	509.6	66.8	812.0	66.9
	18 0	25	18-82	510.6	60.2	816.1	60.4		18 0	25	19-56	495.8	57.3	768.9	58.2
	20 0		16-80	508.4	60.1	830.0	60.1		20 0		19-00	500.5	55.9	791.7	56.6
	22 0		17-99	501.3	60.7	832.0	60.5		22 0		21-51	493.1	55.9	821.7	56.4
Sept. 15	0 0		23-34	502.1	62.1	809.6	61.7	Sept. 22	0 0		24-87	499.0	58.3	813.6	58.1
	2 0		25-81	507.6	65.3	816.5	64.2		2 0		27-58	518.1	62.9	824.1	61.9
	4 0		22-32	505.2	68.3	816.0	66.6		4 0		26-19	517.1	67.4	868.5	65.5
	6 0		19-37	514.7	69.7	803.4	67.6		6 0		22-92	516.3	70.0	816.8	67.6
	8 0		19-13	511.8	68.7	799.3	67.0		8 0		18-55	513.5	69.0	813.4	67.5
	10 20		19-15	512.3	65.7	796.0	65.2		10 0		14-72	507.1	67.0	804.6	66.0
	18 0	25	17-61	510.7	59.0	817.5	59.4		18 0	25	20-11	500.3	57.4	815.4	58.0
	20 0		16-87	506.1	58.0	834.5	58.5		20 0		20-03	501.2	56.1	821.8	56.8
	22 0		20-10	501.0	58.2	840.6	58.4		22 0		20-32	490.2	56.1	824.7	56.5
Sept. 16	0 0		24-94	501.2	60.9	821.5	60.5	Sept. 23	0 0		26-08	501.4	58.4	815.7	58.2
	2 0		24-71	511.2	64.0	826.9	63.2		2 0		26-22	512.3	63.1	851.9	62.0
	4 0		21-10	506.9	67.2	823.2	65.8		4 0		24-33	518.0	67.7	837.0	65.7
	6 0		19-94	514.3	68.2	826.1	66.9		6 0		15-19	526.9	70.7	834.0	68.3
	8 0		19-40	516.4	67.9	807.8	66.8		8 0		20-01	512.2	70.0	798.7	68.0
	10 0		18-99	516.1	66.5	806.3	65.9		10 0		19-83	511.3	68.1	789.5	67.1
Sept. 17	18 0	25	17-52	512.0	60.0	809.2	60.2	Sept. 24	18 0	25	18-75	511.2	59.7	813.6	59.8
	20 0		16-62	506.0	59.8	821.2	60.0		20 0		16-80	507.3	58.6	824.7	58.6
	22 0		17-88	502.8	61.3	798.0	61.1		22 0		20-23	491.8	57.9	823.0	57.9
Sept. 18	0 0		27-29	503.0	63.7	796.1	63.1	Sept. 25	0 0		24-80	497.9	57.7	804.0	57.6
	2 0		29-48	510.4	66.0	793.2	65.0		2 0		26-69	507.6	58.0	829.8	57.7
	4 0		23-54	511.4	65.9	807.3	65.3		4 0		21-29	504.4	58.4	849.3	58.0
	6 0		22-56	521.4	65.1	817.7	64.9		6 0		18-41	505.8	57.7	842.5	57.2
	8 0		20-40	517.6	64.0	820.9	63.0		8 0		18-28	510.9	56.3	838.9	56.1
	10 0		7-65	519.0	62.6	796.7	62.6		10 0		17-67	510.1	55.0	833.7	55.0
	18 0	25	19-98	502.9	55.7	761.4	56.2		18 0	25	18-55	508.8	50.8	820.4	50.9
	20 0		16-40	495.0	54.3	813.9	55.0		20 0		15-66	497.7	50.1	838.1	50.4
	22 0		20-16	475.4	54.3	824.3	54.7		22 0		19-96	488.2	50.6	832.9	50.5
Sept. 19	0 0		29-93	499.3	56.6	823.8	56.5	Sept. 26	0 0		27-34	491.6	51.2	822.6	51.1
	2 0		27-19	512.9	60.0	828.6	59.3		2 0		28-47	502.5	52.6	827.1	52.0
	4 0		23-79	510.0	63.1	823.8	61.8		4 0		24-00	512.0	54.1	848.8	53.0
	6 0		19-29	509.0	64.3	838.7	63.0		6 0		23-07	499.9	54.0	859.4	54.7
	8 0		14-01	507.3	63.7	846.9	62.6		8 0		19-24	507.2	53.4	837.2	53.0
	10 0		19-89	511.2	62.3	780.5	61.8		10 0		12-90	504.9	52.7	812.8	52.5
	18 0	25	18-21	510.2	57.4	818.3	57.6		18 0	25	18-03	505.3	48.1	816.5	48.8
	20 0		18-15	496.1	56.9	838.0	57.0		20 0		16-97	499.6	47.4	836.3	48.0
	22 0		23-06	492.4	57.3	831.8	57.5		22 0		17-88	489.0	47.9	829.1	48.2
Sept. 20	0 0		23-39	500.5	60.6	822.0	60.0	Sept. 27	0 0		24-06	489.1	49.8	811.2	49.6
	2 0		28-45	508.8	63.0	823.9	61.6		2 0		25-95	504.0	52.0	813.7	50.9
	4 0		28-67	514.7	65.9	830.2	64.6		4 0		25-14	512.8	52.3	826.2	51.5
	6 0		19-83	513.3	66.9	833.6	65.5		6 0		22-72	512.3	52.6	827.6	51.9
	8 0		16-17	512.4	66.0	831.0	65.3		8 0		22-92	512.9	51.6	814.7	51.0
	10 0		15-49	510.0	65.0	806.4	64.5		10 0		21-31	514.2	50.0	811.6	50.0

DECLINATION. Torsion removed, circle reading,—Sept. 19^d 23^h, 75°; 27^d 3^h, 73°.
 BIFILAR. $k=0.0001205$. BALANCE. $k=0.000013$ approximately.

Sept. 26^d.—The Declination and Bifilar Magnetometers were supplied with closely fitting rectangular boxes, placed within the cylindrical boxes, for the purpose of destroying currents of air. The boxes of all the Magnetometers were covered inside and outside with gilt paper. The box of the Balance Magnetometer was removed after the observation at 4^h, and replaced before that at 6^h.

Göttingen Mean Time of Declination Observation.			DECLINA- TION.	BIFILAR.		BALANCE.		Göttingen Mean Time of Declination Observation.			DECLINA- TION.	BIFILAR.		BALANCE.				
				Cor- rected.	Thermo- meter.	Cor- rected.	Thermo- meter.					Cor- rected.	Thermo- meter.					
d.	h.	m.	°	'	Sec. Div.	°	'	Mic. Div.	°	'	°	'	Sec. Div.	°	'	Mic. Div.	°	'
Sept. 27	18	0	25	20.32	507.6	45.9	759.7	46.5	Oct. 4	18	0	25	23.46	511.4	58.1	737.3	58.3	
	20	0		22.20	506.4	45.1	780.3	45.9		20	0		23.86	506.2	57.9	747.0	58.0	
	22	0		23.66	478.5	45.3	822.2	45.9		22	0		23.93	486.7	57.9	781.0	57.9	
Sept. 28	0	0		31.36	480.1	47.3	823.9	47.2	Oct. 5	0	0		32.53	493.6	58.2	770.2	58.1	
	2	0		30.89	501.2	50.0	838.2	49.1		2	0		30.69	505.4	60.0	782.8	59.1	
	4	0		28.70	511.6	51.5	855.4	50.3		4	0		27.33	513.2	61.6	798.4	60.4	
	6	0		23.06	512.4	51.9	847.0	50.7		6	0		25.31	505.2	61.5	849.6	60.5	
	8	0		22.25	510.4	51.0	832.2	50.4		8	0		11.05	507.4	60.8	802.9	60.3	
	10	0		20.57	509.4	50.0	835.2	49.9		10	0		19.67	506.0	60.1	766.3	60.0	
	18	0	25	20.79	504.7	44.9	809.1	45.9		18	0	25	22.83	503.2	58.7	746.7	58.5	
	20	0		21.39	504.8	43.9	820.4	45.0		20	0		20.50	501.4	58.7	777.2	58.5	
	22	0		20.79	493.2	44.1	847.3	45.0		22	0		21.34	490.9	58.7	779.0	58.5	
Sept. 29	0	0		25.05	495.4	46.2	812.5	46.4	Oct. 6	0	0		28.50	491.3	59.2	765.6	58.9	
	2	0		27.29	508.4	50.0	812.0	49.0		2	0		27.60	506.2	60.6	782.3	59.9	
	4	0		26.45	519.7	51.9	817.7	50.5		4	0		23.17	512.4	61.1	790.7	60.5	
	6	0		23.83	515.7	52.3	842.1	51.1		6	0		20.41	506.6	61.1	785.4	60.7	
	8	0		17.99	502.9	52.1	854.3	51.1		8	0		21.35	508.6	60.7	775.7	60.4	
	10	0		21.10	511.4	51.9	831.5	51.1		10	0		18.73	502.2	59.9	775.1	59.8	
	18	0	25	19.36	513.8	51.9	778.4	51.4		18	0	25	21.29	502.8	58.7	757.1	57.0	
	20	0		23.14	506.8	52.2	795.1	51.7		20	0		20.37	504.3	58.4	775.2	56.6	
	22	0		22.25	508.2	53.6	791.7	52.8		22	19		22.35	489.1	56.9	782.4	57.0	
Sept. 30	0	0		25.38	502.2	56.7	782.8	55.5	Oct. 7	0	0		26.28	492.8	58.1	775.1	57.9	
	2	0		24.85	500.8	60.0	793.4	58.2		2	0		27.43	504.7	60.0	767.4	59.2	
	4	0		26.43	514.9	61.9	789.0	60.0		4	0		24.06	513.5	62.0	776.5	61.0	
	6	0		23.93	504.9	62.6	824.4	61.0		6	0		22.16	512.5	62.0	765.9	61.0	
	8	0		23.14	511.3	61.8	801.7	60.6		8	0		21.48	511.6	60.5	761.6	60.0	
	10	0		20.63	512.9	60.8	782.4	60.1		10	0		21.32	507.1	59.1	767.6	59.3	
Oct. 1	18	0	25	21.24	504.1	57.0	764.3	57.6	Oct. 8	18	0	25	21.71	505.4	48.3	806.6	49.2	
	20	0		23.53	497.9	56.1	779.5	56.9		20	0		19.87	505.7	47.7	815.1	48.5	
	22	0		23.21	494.2	56.1	791.0	56.6		22	0		21.04	492.7	47.8	820.1	48.4	
Oct. 2	0	0		27.47	498.4	57.0	789.5	57.2	Oct. 9	0	0		25.18	489.6	49.1	822.1	49.2	
	2	0		28.15	503.1	58.6	792.2	58.1		2	0		27.94	499.3	50.2	810.1	49.9	
	4	0		23.27	489.9	59.7	811.1	59.0		4	0		25.22	506.9	50.8	814.6	50.3	
	6	0		23.39	510.8	60.0	801.6	59.2		6	0		21.37	508.3	50.7	822.1	50.1	
	8	0		21.32	509.0	58.7	805.4	58.4		8	0		23.17	513.8	50.1	814.5	49.9	
	10	0		22.30	505.3	57.0	797.3	57.1		10	0		21.84	510.7	49.7	814.6	49.6	
	18	0	25	22.16	506.5	51.6	792.6	52.2		18	0	25	21.98	511.7	47.7	812.8	48.0	
	20	0		31.04	497.6	51.2	768.6	51.7		20	0		25.48	505.5	47.2	823.3	47.6	
	22	0		25.19	497.4	51.5	789.5	51.5		22	0		23.10	499.1	47.2	819.2	47.5	
Oct. 3	0	0		31.32	493.9	52.6	824.3	52.4	Oct. 10	0	0		24.60	494.0	47.7	811.2	47.8	
	2	0		28.15	506.0	54.3	801.3	53.6		2	0		29.29	508.4	48.7	808.5	48.5	
	4	0		25.43	507.0	55.7	806.5	54.9		4	0		26.52	509.0	49.9	810.1	49.3	
	6	0		22.62	508.5	56.0	808.8	55.4		6	0		23.06	512.4	50.1	811.8	49.5	
	8	0		18.53	506.4	56.0	810.9	55.4		8	0		19.63	505.5	49.3	818.8	49.0	
	10	0		20.88	511.7	55.7	798.2	55.2		10	0		15.74	499.9	48.1	809.2	48.3	
	18	0	25	23.32	503.2	53.8	794.7	54.0		18	0	25	21.96	510.5	45.2	808.7	45.9	
	20	0		21.37	505.5	53.6	804.2	53.5		20	0		21.24	504.4	44.9	819.8	45.5	
	22	0		23.17	498.6	53.9	812.5	53.9		22	0		19.93	494.6	44.9	818.4	45.2	
Oct. 4	0	0		27.51	500.3	55.9	812.1	55.0	Oct. 11	0	0		25.36	497.6	44.9	805.6	45.3	
	2	0		30.02	512.6	57.9	801.1	56.8		2	0		26.64	504.3	45.1	811.1	45.5	
	4	0		25.14	519.3	60.3	803.1	58.8		4	0		25.19	517.1	45.3	819.2	45.5	
	6	0		21.59	513.8	61.3	789.6	59.8		6	0		23.16	514.5	45.3	819.9	45.5	
	8	0		22.96	515.0	61.0	781.3	60.0		8	0		22.32	513.0	45.0	821.3	45.4	
	10	0		21.02	510.5	60.5	781.2	59.8		10	0		21.42	513.7	45.0	815.6	45.2	

DECLINATION. Torsion removed, circle reading,—Oct. 6^d 1^h, 88°.
 BIFILAR. $k=0.0001205$. BALANCE. $k=0.000013$ approximately.

Göttingen Mean Time of Declination Observation.			DECLINA- TION.	BIFILAR.		BALANCE.		Göttingen Mean Time of Declination Observation.			DECLINA- TION.	BIFILAR.		BALANCE.			
				Cor- rected.	Thermo- meter.	Cor- rected.	Thermo- meter.					Cor- rected.	Thermo- meter.	Cor- rected.	Thermo- meter.		
d.	h.	m.	°	'	Sc. Div.	°	Mic. Div.	°	d.	h.	m.	°	'	Sc. Div.	°	Mic. Div.	°
Oct. 11	18	0	25	22-08	510.5	43.3	819.2	43.8	Oct. 18	18	0	25	16-89	514.2	53.6	754.6	54.6
	20	0		20-82	507.5	43.2	818.9	43.5		20	0		16-43	514.5	53.4	794.0	54.9
	22	0		20-52	496.4	43.1	819.4	43.5		22	0		17-88	500.3	52.0	820.2	54.0
Oct. 12	0	0		26-84	500.7	43.8	805.5	44.0	Oct. 19	0	0		22-65	503.8	53.7	805.8	55.3
	2	0		28-17	506.8	44.9	813.0	44.7		2	0		24-53	516.0	56.0	786.9	57.0
	4	0		23-79	513.2	46.1	825.4	45.5		4	0		22-08	518.8	58.3	792.9	58.9
	6	0		23-23	515.6	47.0	814.9	46.0		6	0		18-12	512.8	58.6	813.0	59.0
	8	0		22-22	515.4	45.9	813.7	45.5		8	0		19-71	512.3	58.1	816.2	59.0
	10	0		19-56	510.8	44.0	802.1	44.4		10	0		15-69	516.8	56.8	813.8	58.0
	18	0	25	20-70	508.1	37.7	820.8	38.9		18	0	25	17-98	497.1	47.7	759.3	49.5
	20	0		20-50	504.3	36.9	826.0	38.0		20	0		18-59	495.8	46.9	807.5	48.5
	22	0		21-24	499.5	37.1	826.8	38.0		22	0		19-72	490.3	46.9	826.0	48.3
Oct. 13	0	0		28-32	500.6	39.1	821.0	39.5	Oct. 20	0	0		25-95	497.2	47.8	837.4	48.5
	2	0		30-13	513.5	42.0	835.5	41.5		2	0		25-10	511.0	49.0	836.1	49.0
	4	0		27-20	514.6	43.7	865.5	43.0		4	0		23-40	513.8	49.7	838.2	49.5
	6	0		23-50	513.7	43.6	848.7	43.0		6	0		22-23	514.9	49.9	833.0	49.6
	8	0		22-79	512.6	42.4	839.7	42.4		8	0		20-65	506.4	49.5	847.1	49.3
	10	0		22-43	512.9	41.1	833.0	41.5		10	0		21-02	510.6	49.2	830.7	49.2
	18	0	25	21-29	508.5	37.9	820.7	38.7		18	0	25	20-47	510.3	48.0	818.4	48.4
	20	0		20-30	512.5	37.5	824.6	38.3		20	0		20-25	507.3	48.0	830.1	48.3
	22	0		27-29	490.3	37.9	847.7	38.5		22	0		21-30	503.0	48.3	836.6	48.4
Oct. 14	0	0		28-57	502.4	40.2	841.2	40.2	Oct. 21	0	0		24-00	505.9	48.9	829.8	48.6
	2	0		27-98	517.0	43.6	830.7	42.5		2	0		24-52	509.9	50.0	828.1	49.5
	4	0		25-14	517.5	45.6	841.2	44.3		4	0		22-42	514.4	51.5	828.4	50.5
	6	0		22-65	518.4	46.2	839.5	45.0		6	0		22-17	516.2	52.0	813.8	50.9
	8	0		22-72	509.9	45.0	868.5	44.5		8	0		21-24	514.9	51.1	813.3	50.4
	10	0		17-59	501.9	43.0	832.7	43.0		10	0		21-20	511.8	49.3	814.6	49.5
Oct. 15	18	0	25	21-91	504.6	34.9	814.2	36.2	Oct. 22	18	0	25	20-77	511.1	49.9	797.4	50.0
	20	0		23-91	494.6	34.0	827.2	35.4		20	0		19-95	508.0	49.4	812.0	49.8
	22	0		24-13	493.2	34.0	834.1	35.0		22	0		21-90	499.0	49.5	817.4	49.6
Oct. 16	0	0		27-33	491.8	36.2	845.0	36.5	Oct. 23	0	0		26-02	504.5	50.2	808.3	50.0
	2	0		25-96	512.8	39.9	856.0	39.3		2	0		25-87	510.8	51.2	816.4	50.7
	4	0		25-25	519.9	42.9	860.0	41.7		4	0		22-25	514.2	51.7	823.1	51.0
	6	0		22-36	520.3	43.3	858.4	42.4		6	0		22-05	515.8	51.3	805.5	50.9
	8	0		20-72	521.0	42.7	828.5	42.0		8	0		21-33	515.1	51.1	807.1	50.8
	10	0		12-36	549.3	41.5	828.9	41.5		10	0		20-77	513.1	51.2	810.8	50.9
	18	0	25	21-88	508.4	38.7	844.6	39.4		18	0	25	20-25	514.6	49.3	800.8	49.5
	20	0		24-60	494.3	38.5	841.9	39.2		20	0		19-40	508.9	48.7	814.2	49.0
	22	0		24-01	497.9	38.3	840.3	39.0		22	0		19-55	496.0	48.4	818.6	48.6
Oct. 17	0	0		24-89	495.9	38.5	846.4	39.0	Oct. 24	0	0		26-86	502.7	48.6	809.9	48.7
	2	0		18-41	492.4	39.3	901.7	39.7		2	0		28-14	503.9	48.6	819.3	48.7
	4	0		25-32	508.5	39.1	884.6	39.5		4	0		23-13	508.5	48.0	831.9	48.3
	6	0		22-25	507.3	39.0	889.7	39.5		6	0		21-67	514.3	47.1	813.4	47.7
	8	0		22-67	507.6	38.9	855.6	39.3		8	0		21-13	512.0	46.2	812.4	47.0
	10	0		22-58	512.3	38.3	843.6	39.0		10	0		19-95	506.7	45.1	821.9	46.0
	18	0	25	22-32	500.3	34.9	833.0	36.0		18	0	25	19-65	510.9	40.2	825.2	41.6
	20	0		20-90	494.7	34.1	846.6	35.4		20	0		20-90	508.5	39.6	827.6	40.9
	22	0		20-77	494.8	34.2	851.6	35.6		22	0		22-57	496.2	39.3	833.3	40.5
Oct. 18	0	0		24-67	494.7	36.8	837.9	36.8	Oct. 25	0	0		24-86	504.3	41.0	827.5	41.5
	2	0		27-50	518.5	42.0	830.6	41.7		2	0		25-65	511.0	43.6	820.7	43.2
	4	0		24-52	521.8	45.9	827.0	45.0		4	0		23-00	514.0	46.1	842.6	45.2
	6	0		23-00	519.6	49.0	832.8	47.8		6	0		23-28	517.6	47.2	840.1	47.0
	8	0		23-29	514.9	48.2	832.7	47.7		8	0		21-11	515.3	46.2	820.4	45.6
	10	0		16-11	518.9	49.9	816.5	49.8		10	0		20-34	510.9	44.9	820.8	44.9

DECLINATION. Torsion removed, circle reading,—Oct. 14^d 1^h, 97°; 17^d 23^h, 100°; 18^d 9^h, 110°; * 19^d 23^h, 93°.†
 BIFILAR. $k=0.0001205$. BALANCE. $k=0.000013$ approximately.

* Oct. 18^d 0^h—8^h. Magnet with short scale in the Declinometer box.
 † Oct. 19^d 22^h—25^d 22^h. Magnet with short scale in the Declinometer box.

Göttingen Mean Time of Declination Observation.			DECLINA- TION.	BIFILAR.		BALANCE.		Göttingen Mean Time of Declination Observation.			DECLINA- TION.	BIFILAR.		BALANCE.			
				Cor- rected.	Thermo- meter.	Cor- rected.	Thermo- meter.					Cor- rected.	Thermo- meter.				
d.	h.	m.	°	'	Sec. Div.	°	Mic. Div.	°	d.	h.	m.	°	'	Sec. Div.	°	Mic. Div.	°
Oct. 25	18	0	25	19.18	513.9	39.6	815.3	40.8	Nov. 1	2	0	25	23.64	511.7	38.3	847.5	38.4
	20	0		24.82	507.6	38.8	808.5	40.8		4	0		20.77	517.8	41.0	849.4	40.4
	22	0		21.97	497.5	38.7	824.7	39.6		6	0		18.89	517.8	41.9	832.0	41.2
Oct. 26	0	0		25.27	493.4	40.1	853.8	40.6		8	0		18.59	515.7	41.4	828.8	41.0
	2	0		26.28	507.9	42.9	848.7	42.5		10	0		14.42	514.5	40.2	829.0	40.5
	4	0		22.99	500.8	44.9	879.6	44.0		18	0	25	17.07	511.6	37.7	811.2	38.5
	6	0		19.26	498.8	45.2	920.7	44.5		20	0		18.21	509.1	37.3	821.1	38.0
	8	0		20.34	508.3	44.6	861.7	44.3		22	0		19.22	505.8	37.2	831.4	38.0
	10	0		1.14	507.2	42.4	834.1	42.9		23	0		20.20	506.4	37.5	832.3	38.1
	18	0	25	21.04	507.9	36.3	802.4	38.0	Nov. 2	0	0		24.80	510.5	38.3	829.6	38.6
	20	0		20.13	504.1	35.2	823.8	36.7		2	0		25.24	517.6	40.6	830.7	40.4
	22	0		19.93	493.8	35.0	839.2	36.1		4	0		22.85	523.5	42.0	822.7	41.5
Oct. 27	0	0		25.90	493.9	36.5	850.1	37.0		6	0		22.00	525.3	42.6	817.9	42.1
	2	0		24.17	515.1	39.6	857.8	39.3		8	0		20.13	510.3	42.6	834.9	42.3
	4	0		20.40	507.6	41.3	877.8	40.8		10	0		17.07	511.6	42.4	830.2	42.5
	6	0		19.84	510.3	41.9	861.5	41.4		18	0	25	21.98	508.4	38.0	783.9	39.3
	8	0		20.87	512.9	41.8	846.7	41.5		20	0		24.11	507.8	37.6	797.6	38.6
	10	0		19.93	510.6	41.0	835.0	41.0		22	0		21.10	498.0	37.2	825.5	38.3
	18	0	25	20.03	511.1	40.7	834.6	41.0	Nov. 3	0	0		24.94	495.0	37.2	821.2	38.2
	20	0		20.57	511.0	41.1	833.0	41.1		2	0		26.45	493.5	37.5	837.7	38.3
	22	0		20.82	502.3	42.0	835.2	42.0		4	0		25.51	503.7	38.3	859.6	38.8
	23	0		20.90	502.0	42.6	825.9	42.5		6	0		22.33	512.6	39.9	855.0	40.0
Oct. 28	0	0		23.29	495.3	43.0	830.1	42.9		8	0		21.28	514.4	40.6	840.8	40.5
	2	0		23.93	508.9	44.0	828.3	43.6		10	0		13.71	517.6	40.6	836.5	40.5
	4	0		22.97	516.5	44.7	833.7	44.2		18	0	25	19.89	514.2	41.8	816.2	41.7
	6	0		20.63	516.5	44.4	827.5	44.1		20	0		20.48	513.5	42.9	820.2	42.9
	8	0		20.57	515.0	44.0	824.1	44.0		22	0		20.70	505.5	44.0	819.5	43.9
	10	0		18.75	512.9	43.3	820.8	43.5		23	0		23.76	505.8	44.8	816.7	44.5
	18	0	25	19.39	506.2	37.5	820.9	38.9	Nov. 4	0	0		25.54	506.4	45.7	823.9	45.4
Oct. 29	20	0		18.60	507.4	36.7	830.3	38.0		2	0		24.77	522.7	47.8	814.4	47.0
	22	0		19.83	495.4	36.3	841.3	37.5		4	0		21.95	521.8	49.7	805.2	48.5
	23	0		23.32	495.0	36.1	830.2	37.4		6	0		21.78	517.2	49.9	793.3	49.0
Oct. 30	0	0		24.74	494.5	36.3	836.7	37.4		8	0		21.84	518.1	49.7	789.2	48.9
	2	0		27.36	497.2	36.7	851.5	37.5		10	0		20.56	512.1	48.8	798.2	48.4
	4	0		25.92	507.1	36.9	873.3	37.5	Nov. 5	18	0	25	20.60	512.2	46.2	801.8	46.3
	6	0		21.37	510.1	37.0	864.2	37.6		20	0		20.50	511.0	46.8	801.3	46.5
	8	0		22.62	511.0	37.3	851.3	37.8		22	0		23.19	506.4	47.3	801.3	47.0
	10	0		17.76	507.3	37.7	854.1	38.0		23	0		25.78	505.8	47.8	801.0	47.5
	18	0	25	19.39	512.4	37.5	826.8	38.0	Nov. 6	0	0		27.91	507.4	48.6	805.1	48.0
Oct. 31	20	0		20.07	507.8	37.0	836.9	37.6		2	0		27.87	514.2	49.6	812.1	49.0
	22	0		21.28	498.0	36.7	842.8	37.4		4	0		23.90	511.2	50.9	816.2	50.0
	23	0		27.70	491.7	37.0	840.4	37.5		6	0		20.70	515.6	51.0	800.3	50.0
	0	0		26.79	500.4	38.3	841.4	38.5		8	0		20.10	514.4	49.9	792.1	49.4
	2	0		23.93	511.7	41.8	841.9	41.0		10	0		18.62	509.9	48.4	795.3	48.4
	4	0		22.65	517.1	44.1	847.1	43.0		18	0	25	20.13	510.9	46.3	792.4	46.5
	6	0		18.86	513.8	44.6	846.2	43.5		20	0		19.63	508.8	46.1	796.9	46.3
	8	0		12.27	525.2	43.4	823.0	43.0		22	0		19.68	502.0	46.0	803.8	46.2
	10	0		17.88	509.3	41.7	824.4	42.0		23	0		21.24	497.9	46.3	810.8	46.5
	18	0	25	16.85	508.7	36.6	800.3	37.7	Nov. 7	0	0		23.24	501.8	47.0	808.2	47.0
Nov. 1	20	0		17.96	507.1	36.0	809.7	37.0		2	0		24.82	513.6	48.7	810.1	48.3
	22	0		17.14	503.3	35.7	831.7	36.7		4	0		24.53	509.2	49.8	822.9	49.0
	23	9		19.54	498.1	35.9	842.7	36.8		6	0		20.72	509.9	49.3	826.1	48.8
	0	0		21.98	503.2	36.3	844.0	37.0		8	0		20.45	511.2	48.0	814.6	47.9
										10	0		18.59	507.0	46.7	806.2	46.9

DECLINATION. Torsion removed, circle reading.—Oct. 25^d 23^h, 111°; 31^d 1^h, 108°; Nov. 1^d 23^h, 109°.
 BIFILAR. $k=0.0001205$. BALANCE. $k=0.000013$ approximately.

Göttingen Mean Time of Declination Observation.			DECLINA- TION.	BIFILAR.		BALANCE.		Göttingen Mean Time of Declination Observation.			DECLINA- TION.	BIFILAR.		BALANCE.	
				Cor- rected.	Thermo- meter.	Cor- rected.	Thermo- meter.					Cor- rected.	Thermo- meter.	Cor- rected.	Thermo- meter.
Nov. 7	18 0	25	20-55	508.2	43.1	807.4	43.8	Nov. 14	2 0	25	19-15	508.2	41.0	849.2	41.4
	20 0		19-84	505.7	42.2	811.8	43.0		4 0		20-40	515.8	43.0	865.3	42.9
	22 0		18-28	501.3	41.7	811.7	42.4		6 0		17-79	513.4	43.6	864.8	43.4
	23 0		19-77	501.0	41.7	813.0	42.4		8 0		17-23	510.2	42.9	865.6	43.0
Nov. 8	0 0		21-05	503.6	42.0	812.5	42.5		10 0		15-09	503.8	41.8	869.2	42.0
	2 0		21-43	503.4	42.9	824.6	43.1		18 35	25	17-40	506.7	38.6	865.2	39.2
	4 0		22-62	510.0	43.6	833.2	43.5		20 0		18-13	503.5	38.3	867.1	39.0
	6 0		18-37	512.2	43.0	823.1	43.0		22 0		17-19	504.6	38.2	870.2	38.8
	8 0		18-42	508.6	41.8	822.4	42.0		23 0		18-45	502.0	38.1	860.5	38.8
	10 0		15-45	499.7	40.1	830.0	40.7	Nov. 15	0 0		20-08	503.3	38.2	860.3	38.9
	18 0	25	19-95	501.0	36.2	804.6	36.9		2 0		22-99	510.4	38.7	868.6	39.0
	20 0		20-92	511.3	35.6	795.6	36.2		4 0		20-48	507.9	38.9	884.0	39.4
	22 0		19-05*	810.8	35.9		6 0		20-43	507.5	39.1	873.0	39.5
	23 0		21-82	814.9	35.9		8 0		15-49	508.2	39.8	880.0	40.1
Nov. 9	0 0		23-77	456.0	36.4	814.1	36.2		10 0		19-53	511.7	40.0	859.5	40.5
	2 0		22-07	462.6	37.2	827.8	37.1		18 0	25	18-15	511.6	38.0	842.7	38.5
	4 0		19-95	466.0	38.6	837.1	38.3		20 0		19-15	504.9	37.5	863.6	38.0
	6 0		19-12	465.4	38.8	829.7	38.5		22 0		19-29	504.8	37.1	858.7	37.7
	8 0		18-37	465.4	38.3	824.8	38.3		23 0		19-80	502.7	37.1	859.8	37.7
	10 0		17-90	464.1	38.0	820.0	38.0	Nov. 16	0 0		20-94	504.6	37.2	858.3	37.8
	18 16	25	18-26	466.1	37.2	815.5	37.7		2 0		21-21	507.6	37.8	855.9	38.2
	20 0		18-35	466.1	37.3	818.7	37.9		4 0		20-63	513.4	38.6	865.7	38.9
	22 0		18-95	460.0	37.7	824.5	38.0		6 0		21-98	512.8	38.9	864.9	39.0
	23 0		19-70	460.5	37.9	824.1	38.1		8 0		15-86	505.3	38.8	877.8	39.0
Nov. 10	0 0		20-51	462.6	38.2	818.7	38.5		10 0		15-19	504.5	38.8	882.3	39.2
	2 0		21-33	466.3	38.9	822.7	39.0		18 0	25	19-86	509.7	40.5	846.0	40.6
	4 0		19-98	465.3	39.6	838.5	39.5		20 0		17-86	511.7	41.8	849.5	41.6
	6 0		20-08	467.0	39.9	831.6	40.0		22 0		19-06	508.9	42.9	852.5	42.8
	8 0		18-37	505.2†	42.4	828.0	40.5		23 0		20-41	509.0	43.7	850.3	43.9
	10 0		18-07	507.0	41.9	811.2	40.7	Nov. 17	0 0		21-02	509.2	46.0	861.5	45.0
	18 0	25	16-87	510.4	40.8	808.4	41.0		2 0		21-35	515.7	46.3	859.3	45.3
	20 0		17-62	508.9	41.3	810.8	41.3		4 0		19-71	519.1	48.2	854.2	46.4
	22 0		19-61	501.7	41.9	818.3	41.8		6 0		18-65	516.7	47.0	851.4	46.3
	23 0		19-95	500.8	42.1	815.9	42.0		8 0		19-15	514.5	45.8	852.3	45.5
Nov. 11	0 0		21-05	501.9	42.7	818.5	42.5		10 0		16-71	514.4	44.7	853.3	45.0
	2 0		21-69	506.0	43.8	820.1	43.5		18 0	25	18-16	509.8	41.0	846.1	41.7
	4 0		20-90	507.7	44.9	814.4	44.5		20 0		18-01	509.0	40.1	849.0	41.0
	6 0		19-08	503.2	45.0	818.7	44.9		22 0		19-09	507.2	39.8	852.4	40.6
	8 0		18-82	505.2	45.0	817.8	44.9		23 0		20-20	507.3	39.8	840.7	40.5
	10 0		16-27	506.8	44.7	816.5	44.7	Nov. 18	0 0		21 58	510.8	40.0	844.0	40.8
	18 0	25	18-86	509.5	40.9	804.4	41.6		2 0		21-91	515.4	40.9	848.9	41.3
	20 0		17-88	520.7	40.9	803.7	41.6		4 0		21-04	518.4	42.0	852.9	42.0
	22 0		18-63	501.3	41.0	802.8	41.5		6 0		21-21	513.6	42.0	858.8	42.0
	23 0		19-31	503.0	41.1		8 0		19-89	510.0	41.4	874.1	41.7
Nov. 13	0 0		21-91	507.4	41.6		10 0		17-91	509.7	40.7	865.2	41.0
	2 0		22-44	511.3	43.3	Nov. 19	18 0	25	19-60	515.7	40.9	840.1	41.3
	4 0		24-80	500.7	45.7		20 0		18-25	514.7	41.1	844.8	41.5
	6 0		23-23	511.8	46.0		22 0		18-28	510.4	41.3	846.6	41.6
	8 0		15-30	502.6	45.3		23 0		19-87	510.3	41.7	845.3	42.0
	10 0		16-87	504.1	45.0	805.0	45.0	Nov. 20	0 0		21-15	512.3	41.9	838.4	42.0
	18 0	25	18-37	502.0	40.0	833.6	41.0		2 0		21-34	515.8	42.0	844.4	42.1
	20 0		18-56	505.4	39.1	837.7	40.4		4 0		19-67	518.2	42.9	851.1	42.9
	22 0		20-62	501.4	38.6	842.0	39.5		6 0		19-29	519.6	42.9	843.2	43.0
	23 7		20-11	501.4	38.6	831.9	39.5		8 0		19-02	517.1	42.3	841.7	42.5
Nov. 14	0 0		22-87	503.4	38.9	827.0	39.8		10 0		18-48	515.6	41.8	844.3	42.0

DECLINATION. Torsion removed, circle reading,—Nov. 7^d 21^h, 114°; 13^d 23^h, 117°; 15^d 1^h, 108½°.||
 BIFILAR. $k_{\dagger} = 0.0001300$. BALANCE. $k_{\dagger} = 0.000014$ approximately.

Nov. 7^d 22^h—15^d 0^h. Magnet with short scale in the Declinometer box.
 * Nov. 24 23^h. Bifilar magnet removed for the purpose of determining its temperature correction; a spare magnet was substituted, and the instrument ad-
 justed, the value of k being 0.0002263.
 † Nov. 16^d 8^h. Bifilar re-adjusted; observation made at 8^h 40^m.
 ‡ Nov. 12^d 23^h—13^d 15^h. Balance magnet removed for the purpose of determining its temperature correction.
 § Nov. 13^d 2^h. Detecting magnet vibrated in the Declinometer box.

Göttingen Mean Time of Declination Observation.			DECLINATION.	BIFILAR.		BALANCE.		Göttingen Mean Time of Declination Observation.			DECLINATION.	BIFILAR.		BALANCE.	
d.	h.	m.		Cor-rected.	Thermo-meter.	Cor-rected.	Thermo-meter.	d.	h.	m.		Cor-rected.	Thermo-meter.	Cor-rected.	Thermo-meter.
Nov. 20	18	0	25 19-87	518.2	41.0	831.9	41.5	Nov. 27	2	0	25 20.54	520.2	52.2	844.1	50.0
	20	0	18-35	516.4	41.1	835.5	41.5		4	0	19-02	518.1	51.9	843.9	50.1
	22	0	17-34	513.5	41.3	839.9	41.6		6	0	18-41	516.6	50.7	841.7	49.9
	23	0	19-20	513.9	41.7	836.1	42.0		8	0	18-38	516.6	50.0	837.2	49.6
Nov. 21	0	0	20-95	516.2	42.3	835.9	42.5		10	0	17-86	515.1	49.5	840.5	49.5
	2	0	20-82	518.5	43.9	845.6	43.8		18	0	25 17-04	516.2	48.4	833.9	48.5
	4	0	19-89	519.0	44.5	845.6	44.2		20	0	18-48	517.7	48.3	831.2	48.5
	6	0	19-26	516.3	44.0	851.5	44.1		22	0	17-41	512.9	48.2	839.0	48.5
	8	0	14-28	507.3	43.8	864.0	44.0		23	0	18-21	512.1	48.2	837.5	48.5
	10	0	17-81	512.5	43.6	847.9	43.9	Nov. 28	0	0	19-63	512.3	48.2	836.9	48.5
	18	0	25 19-17	516.6	46.3	835.8	46.0		2	0	20-88	515.9	48.2	840.1	48.7
	20	0	18-55	516.7	46.2	830.8	46.0		4	0	21-14	512.6	48.3	851.0	48.7
	22	0	18-95	513.4	46.1	829.8	46.0		6	0	20-54	508.4	48.3	862.3	48.5
	23	0	19-83	513.1	46.0	825.1	46.0		8	0	17-94	511.5	48.2	880.9	48.7
Nov. 22	0	0	21-82	514.5	46.1	822.3	46.2		10	0	17-20	511.3	48.3	866.0	49.0
	2	0	21-91	512.8	46.0	834.2	46.0		18	0	25 17-78	517.5	47.4	836.7	47.0
	4	0	19-26	514.4	45.8	845.9	46.0		20	0	18-01	515.6	47.0	840.0	46.8
	6	0	19-02	515.4	45.2	846.5	45.5		22	9	18-48	509.0	46.6	842.5	46.4
	8	0	18-41	514.0	44.1	841.2	44.7		23	0	19-81	511.5	46.4	836.6	46.4
	10	0	18-12	513.9	43.0	840.7	43.9	Nov. 29	0	0	20-75	511.2	46.3	837.5	46.5
	18	0	25 16-10	515.8	39.0	836.1	40.0		2	0	19-93	512.1	46.6	848.1	47.3
	20	0	18-90	511.2	38.8	831.1	39.5		4	0	20-54	508.5	47.3	859.6	48.0
	22	0	19-46	507.0	38.7	840.2	39.4		6	0	17-85	516.3	47.6	851.8	47.5
	23	0	20-34	504.5	38.6	834.7	39.2		8	0	16-67	515.3	47.0	846.3	46.9
Nov. 23	0	0	21-55	508.0	38.6	832.8	39.1		10	0	16-44	515.0	46.3	846.0	45.9
	2	0	20-54	508.6	38.9	855.7	39.5		18	0	25 15-99	515.1	42.3	837.8	41.2
	4	0	21-41	511.6	39.0	859.0	39.5		20	0	17-72	511.7	41.5	844.2	40.5
	6	0	18-46	514.6	39.0	859.5	39.5		22	0	18-65	509.4	41.0	850.1	40.4
	8	0	17-12	513.1	38.9	851.7	39.4		23	0	19-29	511.3	40.8	845.6	40.6
	10	0	16-71	513.2	38.7	852.9	39.1	Nov. 30	0	0	19-37	511.8	40.8	849.4	40.8
	18	0	25 18-21	514.8	35.8	837.9	36.5		2	0	18-65	514.9	40.9	847.3	41.1
	20	0	17-29	512.3	35.0	837.7	36.0		4	0	17-20	516.6	41.4	846.9	42.0
	22	0	17-34	510.4	34.7	835.7	35.5		6	0	17-27	516.3	42.2	845.7	43.3
	23	0	19-19	512.9	34.9	828.0	35.5		8	0	14-25	515.9	43.0	850.2	44.2
Nov. 24	0	0	21-58	516.6	35.3	826.8	36.0		10	0	16-70	514.2	44.0	850.6	45.0
	2	0	21-17	524.5	38.6	843.9	39.1		18	0	25 17-27	513.0	43.7	832.3	43.5
	4	0	21-41	519.4	43.2	869.0	43.4		20	0	16-44	517.9	42.9	831.2	42.5
	6	0	19-89	524.0	44.9	857.5	44.9		22	0	18-55	507.0	42.0	836.9	41.5
	8	0	19-86	519.4	47.0	865.0	47.5		23	0	21-78	508.2	41.8	841.9	41.3
	10	0	16-71	523.0	51.4	858.6	52.2	Dec. 1	0	0	22-11	510.0	41.3	844.0	41.0
	18	0	25 17-81	521.9	55.3	848.3	57.0		2	0	19-74	511.7	40.9	852.4	40.8
	20	0	17-89	522.8	55.8	838.2	57.5		4	0	21-28	511.1	40.6	856.8	40.6
	22	0	18-46	516.2	55.6	837.8	57.0		6	0	17-67	506.2	40.2	875.7	40.3
	23	0	19-60	512.8	55.0	839.1	57.0		8	0	13-98	508.9	39.9	872.1	39.5
Nov. 25	0	0	20-63	510.7	54.7	848.9	56.5		10	0	10-31	507.9	39.0	868.1	38.5
	2	0	20-40	514.4	54.6	854.9	56.8		18	0	25 17-69	513.0	36.0	838.1	35.5
	4	0	19-39	517.3	54.8	860.1	56.7		20	0	16-38	515.6	35.7	835.5	35.3
	6	0	18-38	518.5	53.9	866.8	55.9		22	0	17-88	503.9	35.6	845.4	35.8
	8	0	18-41	519.3	54.2	859.6	56.5		23	0	21-31	501.5	35.7	848.5	36.3
	10	0	17-91	516.9	54.0	863.6	56.3	Dec. 2	0	0	23-29	505.1	36.0	848.8	36.9
Nov. 26	18	0	25 17-91	521.0	48.7	844.7	48.7		2	0	25-75	496.8	37.3	879.4	39.6
	20	0	18-05	519.2	48.9	847.6	48.9		4	0	23-73	512.5	38.6	887.5	39.9
	22	0	18-01	516.3	49.0	844.2	49.0		6	0	19-24	517.0	39.7	869.3	40.9
	23	0	19-22	515.0	49.1	838.8	49.0		8	0	18-45	515.2	40.4	855.2	41.5
Nov. 27	0	0	20-34	516.8	51.3	839.6	49.5		10	0	17-88	514.6	40.8	851.2	41.6

DECLINATION. Torsion removed, circle reading,—Nov. 23^d 1^h, 112½°; 29^d 1^h, 116½°.
 BIFILAR. $k=0.0001300$. BALANCE. $k=0.000014$ approximately.

Nov. 27^d 18^h. The temperature of the Bifilar magnet, after this, is obtained from a thermometer with its bulb resting in a cup in a brass bar.

Göttingen Mean Time of Declination Observation.			DECLINA- TION.	BIFILAR.		BALANCE.		Göttingen Mean Time of Declination Observation.			DECLINA- TION.	BIFILAR.		BALANCE.					
				Cor- rected.	Thermo- meter.	Cor- rected.	Thermo- meter.					Cor- rected.	Thermo- meter.						
d.	h.	m.	°	'	Sc. Div.	°	Mic. Div.	°	d.	h.	m.	°	'	Sc. Div.	°	Mic. Div.	°		
Dec.	3	18	0	25 18-68	517.8	45.9	817.3	46.5	Dec.	9	2	0	25 24-38	516.3	46.0	834.2	46.5		
					515.1	46.0	820.1	47.0						520.0	46.3	843.4	47.0		
					513.3	46.6	820.6	47.2						512.2	46.7	853.7	47.0		
					513.7	46.7	817.7	47.5						527.3	46.7	852.5	47.0		
Dec.	4	0	0	20-47	511.9	46.8	818.0	47.5						510.4	46.9	849.0	47.7		
					513.7	47.3	825.4	48.3	Dec.	10	18	20	25 23-10	511.1	46.4	778.0	46.9		
					513.2	47.8	830.8	48.5						512.9	46.3	804.8	46.7		
					514.1	48.0	829.3	48.7						501.9	46.2	821.8	46.6		
					513.9	48.0	829.6	48.5						514.0	46.2	821.5	46.7		
					511.5	48.0	837.8	48.5	Dec.	11	0	0	23-19	511.2	46.2	832.1	46.9		
					517.5	47.8	823.3	48.2						515.3	46.7	841.8	47.5		
					517.8	47.9	824.8	48.2						517.7	47.1	852.5	48.0		
					514.8	47.9	822.5	48.2						513.1	47.6	869.3	48.1		
					508.9	47.9	823.3	48.5						6.05	530.6	47.9	867.9	48.9	
Dec.	5	0	0	20-50	510.7	48.0	824.5	48.5						19.34	510.6	48.0	852.5	48.6	
					514.0	48.2	841.1	48.9						21.29	505.7	47.7	826.1	48.0	
					512.6	48.3	843.5	49.0						21.28	518.9	47.5	834.0	47.9	
					512.5	48.2	850.2	48.5						20.63	514.3	47.2	832.4	47.4	
					507.4	47.9	854.3	47.7						20.97	512.9	47.1	830.3	47.4	
					509.5	47.1	853.9	46.7	Dec.	12	0	0	23-93	511.9	47.0	835.0	47.3		
					514.9	44.1	839.3	43.7						510.7	47.0	851.8	47.4		
					515.0	43.9	839.8	43.5						515.7	47.0	887.4	47.6		
					512.4	43.6	841.5	43.4						517.4	47.1	869.9	47.5		
Dec.	6	0	0	24-57	511.0	43.4	847.2	43.5						16.55	506.2	47.3	871.1	48.2	
					513.0	43.6	853.0	44.0						19.39	513.9	47.3	826.1	47.8	
					516.2	44.0	857.8	44.7						20.60	515.0	47.0	832.0	47.4	
					516.7	44.2	850.0	44.8						21.10	514.3	47.0	832.3	47.5	
					511.8	44.3	852.0	44.7						20.60	512.9	47.0	838.8	47.3	
					502.2	44.5	850.2	45.0						21.41	512.9	47.0	835.9	47.3	
					520.5	44.2	816.1	44.7	Dec.	13	0	0	22-22	513.5	46.9	839.5	47.2		
					516.0	44.3	827.8	44.9						514.9	46.9	838.0	47.3		
					514.2	44.5	832.8	45.0						21.84	518.8	46.9	846.6	47.3	
					511.4	44.6	830.2	45.3						20.61	517.3	46.9	846.5	47.2	
Dec.	7	0	0	23-26	512.1	44.7	831.2	45.5						13.62	504.8	46.8	881.4	47.1	
					517.8	45.0	837.2	46.0						21.28	512.6	46.9	849.7	47.2	
					518.0	45.8	843.6	46.5						21.17	514.8	46.9	839.4	47.3	
					518.4	47.3	838.9	47.3						21.55	511.8	47.0	835.8	47.5	
					515.6	47.0	832.4	48.0						21.35	512.5	47.1	835.2	47.5	
					513.7	47.8	832.3	48.7						22.13	511.4	47.0	834.6	47.5	
					518.8	47.0	819.4	47.0	Dec.	14	0	0	23-50	510.9	47.0	837.4	47.5		
					517.5	46.8	822.6	46.8						21.95	513.5	48.2	844.1	47.9	
					514.6	46.6	821.3	46.5						20.74	517.5	48.2	845.7	48.0	
					515.7	46.4	817.1	46.5						18.82	517.0	47.9	843.3	48.0	
Dec.	8	0	0	22-80	515.7	46.4	823.7	46.5						20.13	517.5	47.8	842.8	48.0	
					507.5	46.5	829.1	46.8						17.24	513.6	47.9	839.3	48.0	
					511.2	46.6	850.1	47.0						18.0	25 19-60	517.3	48.9	826.5	49.1
					510.6	46.6	874.8	47.0						20.0	19.81	517.9	49.4	829.3	49.5
					502.8	46.7	947.9	47.2						22.0	20.48	514.6	49.8	833.3	49.9
					494.4	46.9	851.2	47.4						23.0	21.05	513.7	49.9	834.2	50.0
					530.7	46.3	816.0	46.5	Dec.	15	0	0	22-08	513.8	49.9	833.9	50.1		
					533.2	46.1	792.0	46.5						22.40	516.6	49.9	834.3	50.0	
					513.6	46.0	818.2	46.1						21.81	516.6	49.6	846.9	49.6	
					513.1	45.9	813.0	46.1						21.01	514.8	49.0	841.0	49.1	
Dec.	9	0	0	22-58	512.5	45.9	826.9	46.3						20.03	515.4	48.6	839.0	48.6	
														19.31	514.8	48.0	839.3	48.0	

DECLINATION. Torsion removed, circle reading,—Dec. 5^d 3^h, 113½°, 108°; 14^d 3^h, 115°.
 BIFILAR. $k=0.0001300$. BALANCE. $k=0.000014$ approximately.

* Dec. 5^d 3^h. After removing the torsion from the suspension thread of the Declinometer, the magnet, being too near the copper ring, was wound up a little, and the torsion again removed as above.

Dec. 7^d 19^h. A mistake in the time of an hour was made this morning, which was not discovered till 8^h 40^m, when an observation was made.

Dec. 14^d 1^h. Removed the inner box from the Bifilar Magnetometer for comparisons of thermometers. See *Introduction*.

Göttingen Mean Time of Declination Observation.			DECLINA- TION.		BIFILAR.		BALANCE.		Göttingen Mean Time of Declination Observation.			DECLINA- TION.		BIFILAR.		BALANCE.	
					Cor- rected.	Thermo- meter.	Cor- rected.	Thermo- meter.						Cor- rected.	Thermo- meter.	Cor- rected.	Thermo- meter.
d.	h.	m.	°	'	Sc. Div.	°	Mic. Div.	°	d.	h.	m.	°	'	Sc. Div.	°	Mic. Div.	°
Dec. 15	18	0	25	19-61	517.8	44.6	832.3	44.2	Dec. 22	2	0	25	20-10	519.7	49.0	839.8	49.4
	20	0		19-89	519.2	44.0	834.5	43.6		4	0		18-63	520.3	49.3	841.5	49.8
	22	0		20-05	515.9	43.4	839.0	43.0		6	0		18-08	520.2	49.9	836.2	50.3
	23	0		20-97	515.4	43.2	835.3	43.0		8	0		17-59	516.6	50.1	834.8	50.5
Dec. 16	0	0		22-33	515.2	43.0	836.2	43.0		10	0		16-91	516.7	50.3	831.8	50.6
	2	0		22-58	516.9	43.0	835.6	43.4		18	0	25	17-74	521.1	49.7	827.4	49.9
	4	0		20-52	518.0	43.3	837.9	43.5		20	0		17-24	520.6	49.6	826.3	49.7
	6	0		20-17	517.8	43.2	838.9	43.4		22	0		17-54	514.9	49.3	827.8	49.5
	8	0		19-96	516.8	42.9	838.8	43.0		23	0		18-01	515.7	49.2	825.5	49.4
	10	0		19-87	517.4	42.7	841.5	42.9	Dec. 23	0	0		19-26	518.1	49.1	827.5	49.3
Dec. 17	18	0	25	20-07	520.4	45.6	819.3	45.7		2	0		20-20	519.1	49.1	828.8	49.4
	20	0		19-60	510.8	45.3	823.1	45.5		4	0		18-87	520.0	49.1	838.3	49.5
	22	0		19-44	517.7	45.1	827.3	45.4		6	0		18-60	517.4	49.2	837.1	49.5
	23	0		20-50	516.4	45.1	827.2	45.5		8	0		18-33	520.3	49.4	837.3	49.7
Dec. 18	0	0		20-70	517.6	45.0	828.8	45.5		10	0		16-84	517.8	49.7	836.5	49.9
	2	0		21-97	515.9	45.3	833.9	45.7	Dec. 24	18	0	25	17-49	522.3	49.6	815.7	49.5
	4	0		20-94	517.5	45.7	839.8	46.0		20	0		17-31	524.7	49.5	816.1	49.5
	6	0		20-23	512.2	45.7	846.1	46.0		22	0		17-36	520.7	49.4	817.5	49.5
	8	0		16-84	510.8	45.5	856.7	45.8		23	0		18-68	514.9	49.4	822.4	49.6
	10	0		16-87	516.7	45.3	848.3	45.5	Dec. 25	0	0		21-21	517.7	49.4	823.9	49.6
	18	0	25	17-41	519.1	44.5	820.9	44.9		2	0		20-75	518.9	49.6	828.0	49.8
	20	0		18-21	517.9	44.4	825.2	44.7		4	0		19-56	520.0	49.8	829.2	50.0
	22	0		17-86	519.5	44.3	827.3	44.6		6	0		18-12	517.7	49.9	832.9	50.0
	23	0		18-55	520.0	44.3	820.3	44.6		8	0		18-01	517.3	49.7	832.5	49.8
Dec. 19	0	0		18-46	518.0	44.2	828.9	44.7		10	0		16-60	517.0	49.1	831.2	49.5
	2	0		21-39	520.0	44.3	832.6	44.7	Dec. 26	18	0	25	19-00	519.6	48.0	830.0	48.1
	4	0		21-10	518.0	44.2	837.2	44.7		20	0		17-18	521.3	47.9	827.9	48.0
	6	0		19-89	518.6	44.1	832.9	44.6		22	0		17-85	515.7	47.8	833.1	47.8
	8	0		17-91	518.9	44.1	834.8	44.6		23	0		19-46	514.6	47.7	827.9	47.7
	10	0		17-41	517.4	44.0	837.1	44.5	Dec. 27	0	0		20-70	514.4	47.7	836.0	48.0
	18	0	25	18-55	519.4	44.6	826.1	45.0		2	0		22-47	518.8	48.0	830.5	48.5
	20	0		18-52	517.4	44.7	825.3	45.1		4	0		19-91	515.8	48.4	839.3	48.7
	22	0		19-63	518.4	44.8	819.7	45.2		6	0		19-13	517.8	48.4	836.4	48.7
	23	0		21-88	518.3	44.8	817.9	45.3		8	0		17-88	517.8	48.1	834.2	48.5
Dec. 20	0	0		21-42	519.0	44.9	823.7	45.4		10	0		17-41	518.2	47.8	831.2	48.0
	2	0		22-94	514.4	45.1	833.3	45.6	Dec. 28	18	0	25	16-38	521.2	46.7	822.5	46.8
	4	0		21-24	514.0	45.9	856.5	46.6		20	0		17-83	520.8	46.6	823.0	46.7
	6	0		19-80	513.6	48.0	843.6	49.0		22	0		19-76	516.8	46.4	823.0	46.5
	8	0		18-55	517.3	51.4	840.5	53.5		23	0		21-24	510.9	46.4	829.4	46.5
	10	0		17-27	516.0	52.7	839.8	54.7	Dec. 29	0	0		22-65	513.5	46.4	830.1	46.5
	18	0	25	18-53	520.4	57.0	824.6	59.3		2	0		21-21	517.0	46.4	827.7	46.8
	20	0		18-41	518.7	57.0	831.1	59.5		4	0		19-94	518.7	46.7	840.5	47.0
	22	0		17-27	516.2	57.0	834.5	59.2		6	0		20-81	503.1	46.7	876.4	46.9
	23	0		18-35	514.9	56.4	836.7	58.4		8	0		17-92	513.6	46.7	885.1	47.2
Dec. 21	0	0		19-22	513.7	56.1	843.5	58.5		10	0		17-04	514.3	46.2	858.7	46.5
	2	0		20-88	517.7	56.4	840.7	58.6	Dec. 30	18	0	25	15-14	523.6	44.7	824.1	44.8
	4	0		20-43	518.9	57.0	841.3	59.0		20	0		17-44	522.3	44.4	828.9	44.6
	6	0		20-63	516.5	56.3	841.2	58.2		22	0		24-60	511.7	44.1	834.7	44.4
	8	0		20-21	515.3	55.4	835.4	57.0		23	0		23-07	516.5	44.1	827.5	44.3
	10	0		8-55	522.1	54.6	820.7	55.7	Dec. 31	0	0		23-07	511.9	44.0	839.6	44.4
	18	0	25	18-70	518.9	50.3	829.0	50.5		2	0		23-32	506.0	44.6	866.3	45.1
	20	35		17-54	518.4	49.6	828.4	49.6		4	0		21-41	515.3	45.3	878.0	45.9
	22	0			6	0		20-57	511.1	45.6	867.8	46.0
	23	6		18-43	518.5	49.0	832.9	49.1	Dec. 32	8	0		17-20	514.4	45.7	862.6	46.0
Dec. 22	0	0		19-12	517.9	48.9	836.8	49.0		10	0		17-11	511.0	45.7	851.7	46.0

DECLINATION. Torsion removed, circle reading,—Dec. 17^d 23^h, 122¹/₂°.
 BIFILAR. $k=0.0001300$. BALANCE. $k=0.000014$ approximately.

Dec. 18^d 0^h—2^h. Magnet with short scale in the Declinometer.

Göttingen Mean Time of Declination Observation.			DECLINA- TION.		BIFILAR.		BALANCE.		Göttingen Mean Time of Declination Observation.			DECLINA- TION.		BIFILAR.		BALANCE.	
d.	h.	m.	°	'	Cor- rected.	Thermo- meter.	Cor- rected.	Thermo- meter.	d.	h.	m.	°	'	Cor- rected.	Thermo- meter.	Cor- rected.	Thermo- meter.
			Se. Div.	°			Mic. Div.	°				Se. Div.	°			Mic. Div.	°
Dec. 28	18	0	25	18.41	517.1	45.3	830.8	45.7	Dec. 29	18	0	25	18.43	519.2	46.3	823.1	46.5
	20	0		18.06	517.5	45.2	833.0	45.7		20	0		18.25	518.1	46.0	824.8	46.4
	22	0		17.78	515.7	45.3	835.4	45.7		22	0		19.89	512.5	46.0	835.8	46.3
	23	0		18.55	512.7	45.3	835.0	45.8		23	0		17.18	516.7	46.0	836.9	46.3
Dec. 29	0	0		18.93	513.7	45.3	837.5	45.9	Dec. 30	0	0		19.17	513.6	46.0	833.8	46.4
	2	0		20.99	515.8	45.8	833.8	46.3		2	0		21.21	511.9	46.2	844.1	46.7
	4	0		19.89	514.5	46.7	838.2	47.0		4	0		18.82	517.6	46.3	841.3	46.8
	6	0		19.73	516.5	46.9	835.5	47.2		6	0		17.64	515.5	46.3	839.3	46.5
	8	0		19.15	512.8	46.9	842.0	47.2		8	0		17.92	507.2	46.0	855.3	46.2
	10	0		12.50	508.6	46.8	837.9	47.0		10	0		15.22	514.2	45.8	849.8	46.0

DECLINATION. Torsion removed, circle reading,—Jan. 1^d 3^h, 1844, 120 $\frac{1}{2}$ °.
 BIFILAR. $k=0.0001300$. BALANCE. $k=0.000014$ approximately.

TERM-DAY OBSERVATIONS

OF

MAGNETOMETERS.

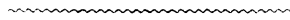

MAKERSTOUN OBSERVATORY,

1843.

Göttingen Mean Time of Declination Observation	JANUARY 18, 19.																	
	DECLINA- TION.	BIFILAR Corrected.	BALANCE Corrected.	DECLINA- TION.	BIFILAR Corrected.	BALANCE Corrected.	DECLINA- TION.	BIFILAR Corrected.	BALANCE Corrected.	DECLINA- TION.	BIFILAR Corrected.	BALANCE Corrected.						
	° ' "	Sec. Div.	Mic. Div.	° ' "	Sec. Div.	Mic. Div.	° ' "	Sec. Div.	Mic. Div.	° ' "	Sec. Div.	Mic. Div.						
Min.																		
	10 ^h .			14 ^h .			18 ^h .			22 ^h .								
0	25 27-36	533-5	781-8	25 27-85	557-2	753-5	25 27-81	538-5	755-8	25 27-78	532-5	763-3						
5	27-29	533-6	781-3	27-58	537-2	753-9	27-71	538-4	754-8	28-08	532-1	764-2						
10	26-79	533-2	781-7	27-13	537-3	754-6	27-73	538-0	754-8	27-80	532-6	761-6						
15	26-69	533-7	779-7	26-94	538-1	754-6	27-65	538-2	756-4	28-00	532-3	762-0						
20	26-66	534-2	779-1	27-17	537-5	755-4	28-05	537-9	757-9	27-58	529-5	761-9						
25	26-75	533-9	776-0	27-29	537-5	756-4	28-21	537-4	758-6	27-71	530-3	762-5						
30	26-80	534-5	775-4	27-34	538-3	755-6	28-34	537-1	759-6	28-17	529-8	762-1						
35	27-29	534-5	774-4	27-56	538-7	756-2	28-14	537-4	760-1	28-25	529-8	764-8						
40	26-91	534-8	773-6	27-78	537-9	756-7	28-27	537-3	760-6	28-17	529-5	762-2						
45	26-75	534-5	773-1	27-43	537-9	757-1	27-96	537-9	761-2	27-93	529-4	762-5						
50	26-28	534-3	772-3	27-46	537-4	758-2	27-93	537-6	760-5	27-93	529-4	763-8						
55	26-48	534-3	772-8	27-34	538-2	757-4	27-40	538-6	758-2	28-15	530-4	764-3						
	11 ^h .			15 ^h .			19 ^h .			23 ^h .								
0	25 26-75	534-0	773-2	25 27-78	538-4	758-2	25 27-73	538-5	759-5	25 28-62	528-9	764-1						
5	26-86	532-2	772-6	28-10	537-7	758-9	27-67	537-8	759-6	28-88	530-5	764-6						
10	25-31	532-6	769-9	28-50	537-3	759-5	27-83	537-5	757-2	28-88	528-9	768-8						
15	22-99	533-1	769-2	28-42	537-5	759-4	27-80	537-7	756-4	28-34	527-8	768-7						
20	21-55	535-4	768-2	28-42	539-2	759-0	27-83	538-0	755-8	27-98	531-4	769-5						
25	20-23	539-2	764-8	28-50	539-4	758-4	27-49	535-9	757-1	28-81	530-5	770-6						
30	18-68	543-3	762-6	28-82	538-8	758-0	27-34	536-7	757-6	28-89	530-1	771-1						
35	19-10	546-6	762-7	28-27	537-8	759-0	27-49	537-7	755-8	29-38	527-6	772-9						
40	20-61	544-7	762-5	28-12	537-3	758-9	27-46	538-1	752-8	29-17	529-2	772-1						
45	21-39	541-4	763-4	27-67	537-0	758-8	27-74	537-8	751-1	29-41	529-3	771-7						
50	22-03	537-6	762-4	27-33	536-0	758-5	27-74	537-4	750-5	29-21	528-7	772-2						
55	22-62	537-3	762-8	27-09	537-4	759-2	27-98	536-4	749-2	29-68	529-3	772-0						
	12 ^h .			16 ^h .			20 ^h .			0 ^h .								
0	25 23-29	536-4	762-1	25 28-08	538-8	759-3	25 27-98	536-2	747-7	25 29-83	529-3	771-8						
5	24-00	534-8	762-6	28-00	538-8	758-8	27-96	536-0	747-6	30-05	529-4	773-4						
10	24-06	532-8	762-4	28-44	538-3	759-4	28-07	536-0	750-3	30-13	529-2	772-8						
15	23-86	534-3	761-5	28-52	538-1	758-8	28-15	536-1	748-2	29-95	528-8	773-5						
20	24-30	536-8	760-8	28-48	538-4	756-6	28-07	536-0	749-1	29-88	529-0	774-0						
25	24-99	537-6	758-7	28-57	538-7	756-6	28-00	536-7	750-4	30-25	528-9	775-1						
30	25-41	536-4	758-7	28-28	538-8	755-3	28-17	535-9	755-2	30-63	529-9	774-7						
35	25-41	536-6	758-7	28-41	538-7	755-8	27-68	536-0	756-6	30-69	529-2	776-9						
40	25-59	536-1	758-5	28-20	538-8	755-4	27-76	536-0	760-4	30-68	529-1	776-6						
45	25-95	536-1	758-9	28-01	538-3	754-7	27-78	535-8	758-8	30-42	529-3	776-4						
50	25-95	537-3	757-9	28-34	537-8	755-3	27-67	536-4	759-3	30-53	529-7	776-0						
55	26-10	536-4	757-5	28-64	537-7	757-2	27-80	536-4	761-1	30-71	531-0	776-2						
	13 ^h .			17 ^h .			21 ^h .			1 ^h .								
0	25 26-26	536-7	758-3	25 28-89	537-3	756-6	25 27-98	535-7	759-4	25 31-19	530-3	776-8						
5	26-30	535-9	758-1	28-75	537-0	756-4	28-01	535-9	759-8	31-19	530-1	777-3						
10	26-05	536-0	756-5	28-34	537-3	756-9	27-93	535-4	759-7	31-32	529-6	776-7						
15	25-95	535-4	756-4	28-03	537-2	756-5	27-71	535-1	759-1	31-53	530-0	777-2						
20	25-73	535-1	756-5	28-67	537-7	757-6	27-94	534-7	759-3	32-20	530-8	776-4						
25	25-95	534-4	756-9	29-65	537-9	757-3	27-96	534-3	763-0	32-27	531-2	775-2						
30	25-95	534-4	755-7	28-89	537-4	755-5	27-87	534-1	762-0	31-99	530-6	775-8						
35	25-95	535-3	756-1	28-32	537-6	755-3	27-78	533-4	761-8	31-99	531-3	774-5						
40	26-22	536-3	756-5	27-98	538-0	754-9	27-49	533-9	761-7	32-20	531-9	774-4						
45	27-29	536-7	756-9	27-90	538-2	757-4	27-53	532-2	763-8	32-05	530-4	776-4						
50	27-90	537-0	755-9	27-83	538-2	756-5	27-26	530-9	762-6	31-66	530-6	777-0						
55	27-96	537-8	755-0	27-83	538-2	756-4	27-40	533-0	762-2	31-66	531-4	776-0						
Hour,			10	11	12	13	14	15	16	17	18	19	20	21	22	23	0	1
BIFILAR THERMOMETER,		56-8	57-7	58-6	59-7	60-4	60-9	61-4	61-3	60-8	60-2	59-5	59-0	59-3	58-8	58-3	58-5	
BALANCE THERMOMETER,		58-2	58-8	59-5	60-4	61-2	61-8	62-2	62-2	61-8	62-2	62-0	61-6	61-0	60-2	59-8	60-0	
OBSERVER'S INITIAL,		B	B	B	B	D	D	D	D	W	W	W	W	W	H	H	H	H
BIFILAR. $k=0.0001248$. Observed 2 ^m after the Declination. BALANCE. $k=0.000015$ approximately. Observed 3 ^m after the Declination.																		

Göttingen Mean Time of Declination Observation.	JANUARY 18, 19.						FEBRUARY 24, 25.					
	DECLINATION.	BIFILAR Corrected.	BALANCE Corrected.	DECLINATION.	BIFILAR Corrected.	BALANCE Corrected.	DECLINATION.	BIFILAR Corrected.	BALANCE Corrected.	DECLINATION.	BIFILAR Corrected.	BALANCE Corrected.
Min.												
		2h.			6h.			10h.			14h.	
0	25 31-99	533-3	775-1	25 29-04	540-7	767-9	25 20-16	527-0	783-2	25 20-55	527-1	693-2
5	32-05	532-2	775-1	28-67	541-7	765-4	20-48	526-4	782-9	21-37	528-4	699-4
10	31-86	532-0	775-0	28-62	541-1	766-5	21-07	526-9	782-1	21-98	529-0	705-6
15	31-73	533-7	773-6	29-41	538-9	765-6	21-53	525-2	784-5	22-42	531-5	708-4
20	31-64	534-3	773-4	29-29	540-1	766-0	21-82	523-5	784-5	23-06	532-4	709-8
25	31-35	534-9	773-5	29-02	540-6	764-9	21-91	523-5	785-2	23-70	531-6	712-5
30	31-32	535-4	773-5	29-29	541-0	764-8	22-42	523-1	785-9	23-86	532-6	715-8
35	31-19	536-4	773-5	28-97	540-2	764-8	23-19	522-0	785-6	24-69	533-8	716-1
40	31-19	537-2	773-5	29-24	539-0	765-8	24-08	521-2	785-4	25-14	532-1	718-2
45	30-90	537-6	773-5	29-31	538-2	767-6	20-77	527-1	776-9	25-18	533-7	717-9
50	30-85	539-0	773-5	29-48	537-9	766-9	16-94	527-1	769-9	25-14	534-0	717-3
55	30-85	539-8	773-8	28-08	536-1	767-2	15-12	526-7	764-0	24-25	532-9	721-2
		3h.			7h.			11h.			15h.	
0	25 30-90	540-5	774-5	25 27-83	536-3	767-6	25 15-19	527-6	760-4	25 23-90	533-4	723-4
5	30-83	540-0	774-6	27-17	535-7	767-4	17-05	525-0	759-6	24-10	535-5	724-4
10	30-65	540-6	775-8	27-00	535-5	766-0	19-42	524-8	759-0	25-09	536-3	724-1
15	30-58	541-0	776-3	27-46	536-0	765-8	26-93	534-7	748-9	25-66	536-7	723-4
20	30-18	540-0	777-1	27-33	537-2	765-9	32-10	543-2	737-7	25-14	538-9	720-5
25	30-02	540-4	778-0	27-44	536-9	763-0	36-56	544-3	718-9	24-22	535-1	719-4
30	29-85	540-9	777-1	27-74	536-9	764-9	35-53	534-7	691-1	22-03	536-7	716-9
35	29-91	541-7	778-0	27-83	536-7	762-0	31-07	526-2	670-6	21-91	538-8	718-0
40	29-85	541-9	779-0	27-27	537-0	761-9	25-45	524-3	667-3	21-91	538-7	719-6
45	29-89	542-7	779-4	27-70	537-7	761-3	21-81	525-9	674-0	22-56	535-6	721-5
50	29-85	542-5	780-2	27-88	537-9	760-5	18-86	526-5	679-8	22-85	534-6	723-7
55	29-88	542-3	781-1	27-88	538-0	758-7	16-43	527-6	684-5	24-01	535-0	723-5
		4h.			8h.			12h.			16h.	
0	25 30-00	542-1	780-8	25 27-85	538-0	758-1	25 15-03	526-9	692-5	25 24-50	534-5	724-6
5	29-86	541-4	779-0	28-07	537-9	759-1	18-95	514-5	699-8	25-14	535-2	723-5
10	29-85	541-4	779-5	28-57	537-5	759-4	23-76	505-7	705-8	25-32	536-5	721-7
15	29-62	541-4	781-5	28-48	537-2	758-6	27-29	498-0	706-9	25-07	535-4	719-7
20	29-62	542-4	779-2	28-59	536-8	757-5	32-02	495-2	702-1	24-40	535-6	720-9
25	29-38	542-0	778-8	28-52	535-8	757-1	33-17	502-2	690-6	24-31	536-3	721-7
30	29-58	541-9	778-3	27-94	534-5	756-5	33-13	512-0	673-9	24-80	534-5	723-4
35	29-49	541-7	777-6	27 16	534-9	756-0	30-77	519-5	662-8	24-67	533-2	724-4
40	29-60	542-1	775-7	26-70	534-1	756-1	29-11	528-2	660-4	24-99	532-4	726-1
45	29-38	541-7	776-3	26-33	534-1	756-4	25-90	537-2	659-3	26-22	529-9	728-1
50	29-46	542-2	776-4	26-06	535-2	756-8	24-00	536-7	656-4	27-47	526-8	728-4
55	29-31	541-8	777-5	26-06	534-9	757-6	22-09	540-0	657-3	28-17	525-5	728-4
		5h.			9h.			13h.			17h.	
0	25 29-31	541-5	775-9	25 26-48	534-4	758-4	25 20-99	537-6	654-0	25 29-31	527-0	725-9
5	29-22	541-3	774-4	26-79	534-1	761-6	18-36	535-3	651-5	29-78	530-1	724-0
10	29-26	540-9	776-2	26-96	533-6	761-4	16-80	535-0	650-0	30-39	526-7	723-9
15	29-17	541-2	773-9	26-99	533-8	761-3	14-20	535-0	648-4	31-25	527-0	720-8
20	29-26	539-8	772-4	27-56	534-0	760-9	12-65	537-1	652-8	31-79	528-6	717-1
25	29-31	541-1	769-8	27-38	532-7	760-5	12-70	538-6	656-9	31-99	527-5	715-3
30	28-70	542-2	769-4	26-15	532-2	760-7	14-70	534-1	659-4	31-32	529-4	712-0
35	28-59	542-0	769-1	24-72	533-9	760-5	16-33	532-6	663-6	31-12	531-8	710-9
40	29-04	541-8	767-5	24-55	533-7	762-8	17-91	529-4	668-3	30-65	534-3	708-6
45	28-95	541-4	771-1	24-94	535-0	763-8	19-36	526-5	675-2	30-58	536-9	706-0
50	29-01	540-1	768-5	24-80	533-8	765-5	19-98	524-2	680-8	29-38	538-7	703-5
55	29-11	540-7	767-4	24-87	533-6	766-1	19-86	526-5	686-2	28-50	539-5	701-1

Hour,	2	3	4	5	6	7	8	9	10	10	11	12	13	14	15	16	17
BIFILAR THERMOMETER, .	58-3	58-3	59-0	59-8	60-3	60-6	60-3	59-7	59-2	52-7	52-3	52-0	53-1	53-1	53-0	53-0	53-0
BALANCE THERMOMETER, .	60-0	59-8	60-3	61-0	61-5	62-0	61-5	60-9	60-5	54-2	54-1	54-0	55-3	55-0	55-2	55-4	55-5
OBSERVER'S INITIAL, . .	B	B	H	H	W	W	D	D		D	D	D	D	W	W	W	W

BIFILAR. $k=0.0001205$. Observed 2^m after the Declination.
 BALANCE. $k=0.000015$ approximately. Observed 3^m after the Declination.

February Term. For observations before and after this Term, see *Extra Observations*.

Göttingen Mean Time of Declination Observation.	FEBRUARY 24, 25.																		
	DECLINATION.			BIFILAR Corrected.			BALANCE Corrected.			DECLINATION.			BIFILAR Corrected.			BALANCE Corrected.			
	°	'	Sec. Div.	Mic. Div.	°	'	Sec. Div.	Mic. Div.	°	'	Sec. Div.	Mic. Div.	°	'	Sec. Div.	Mic. Div.	°	'	Sec. Div.
Min.	18 ^h .			22 ^h .			2 ^h .			6 ^h .									
0	25	27-85	539-2	701-2	25	26-35	529-2	743-4	25	28-70	535-7	748-6	25	27-19	534-5	750-1			
5		27-70	537-2	695-5		25-88	530-3	743-7		28-70	536-1	747-8		27-27	535-8	749-3			
10		26-96	536-2	703-6		26-28	530-1	744-0		28-64	536-2	746-4		27-16	536-3	751-8			
15		26-08	537-4	703-5		26-42	530-5	744-0		28-57	535-6	746-1		27-06	536-4	753-1			
20		26-22	537-1	708-3		26-62	530-0	745-5		28-70	537-3	745-2		27-22	535-4	753-6			
25		26-28	537-0	705-0		26-42	530-2	743-9		28-70	536-1	745-6		27-19	536-3	750-2			
30		26-08	535-3	710-0		26-82	528-9	745-4		28-57	536-1	745-5		27-07	534-8	753-6			
35		25-95	535-7	712-5		26-08	529-6	745-7		28-64	537-0	745-4		26-69	535-1	752-5			
40		25-95	535-3	714-1		26-69	526-5	746-1		28-65	535-7	743-9		26-75	535-7	752-5			
45		25-75	537-1	716-3		25-75	532-5	746-5		28-45	534-6	745-4		26-75	535-7	751-4			
50		26-28	536-1	717-8		26-48	528-7	748-2		28-50	535-3	744-8		26-67	535-8	749-6			
55		26-08	538-0	717-8		26-67	529-9	747-8		28-50	535-3	745-1		26-57	535-1	749-8			
		19 ^h .				23 ^h .				3 ^h .				7 ^h .					
0	25	26-43	538-4	716-4	25	26-72	530-2	748-9	25	28-39	535-1	743-8	25	26-62	535-8	749-6			
5		26-37	538-3	719-1		27-06	528-9	749-8		28-10	534-9	743-6		26-52	536-3	750-1			
10		26-35	537-6	723-7		27-09	530-0	746-0		28-03	536-1	744-3		26-25	536-7	750-5			
15		26-25	536-4	724-1		27-63	529-7	746-2		27-93	535-3	743-5		26-05	537-7	749-1			
20		25-95	536-3	725-4		27-70	529-3	746-1		27-94	535-7	743-8		26-39	537-3	749-4			
25		25-63	536-1	725-5		27-49	529-0	745-2		27-83	534-9	745-3		25-95	537-1	750-0			
30		25-78	535-9	727-5		27-70	529-4	745-7		27-93	535-9	747-0		26-37	538-2	750-5			
35		25-65	534-8	728-1		27-56	529-8	745-6		27-83	535-3	752-6		26-50	539-5	748-9			
40		25-31	534-7	731-4		27-56	530-2	745-4		27-85	535-5	748-1		26-39	538-1	749-3			
45		25-48	534-8	730-5		27-96	530-0	745-3		27-80	535-8	751-7		26-55	536-7	749-8			
50		25-45	535-1	733-7		27-56	527-9	746-4		27-96	536-0	747-0		26-39	537-5	750-1			
55		25-81	534-4	733-6		27-29	528-5	746-0		27-80	535-7	747-1		26-28	536-9	750-5			
		20 ^h .				0 ^h .				4 ^h .				8 ^h .					
0	25	25-58	534-5	734-2	25	28-03	528-1	25	27-70	536-9	748-5	25	25-95	536-0	747-8			
5		25-95	534-2	733-9		28-54	527-3	747-5		27-71	536-1	749-1		25-95	536-0	748-5			
10		25-48	534-3	734-7		28-58	526-0	747-9		27-44	537-9	748-7		25-95	536-5	748-9			
15		25-63	533-5	734-8		28-64	527-6	747-1		27-73	537-3	750-4		25-16	538-1	750-9			
20		25-32	534-2	734-8		27-96	529-6	747-0		27-22	533-7	749-8		25-98	533-9	752-7			
25		25-37	533-9	734-9		29-04	531-3	746-9		27-41	537-4	749-0		25-75	535-4	752-5			
30		25-16	534-6	735-5		28-97	531-0	746-8		27-70	538-9	750-5		24-87	534-9	753-0			
35		25-21	534-1	736-9		28-74	530-0	746-8		27-20	536-8	752-6		25-81	535-7	752-4			
40		25-54	535-7	740-2		28-27	530-3	746-7		27-11	536-2	752-7		25-95	538-0	750-2			
45		26-35	530-7	740-9		28-67	531-8	745-6		27-11	536-3	753-0		25-95	538-8	749-8			
50		25-58	532-5	742-8		28-70	530-9	746-7		26-82	535-8	753-0		25-95	539-2	750-2			
55		25-81	531-8	742-1		28-23	531-8	747-1		26-77	535-5	753-8		25-95	539-4	750-6			
		21 ^h .				1 ^h .				5 ^h .				9 ^h .					
0	25	25-36	531-4	743-8	25	28-54	533-0	746-7	25	26-82	535-3	752-7	25	25-95	541-4	751-0			
5		25-75	530-7	741-4		28-64	533-2	748-3		26-94	534-7	753-1		25-95	539-3	751-2			
10		25-14	531-3	744-0		28-70	533-0	748-4		27-06	534-9	752-8		25-95	539-0	748-3			
15		25-68	531-1	742-3		28-70	533-3	748-5		26-69	532-7	752-0		24-20	538-7	749-6			
20		25-54	530-7	742-5		28-64	534-2	748-6		26-66	531-9	752-4		23-76	537-6	750-2			
25		25-02	530-8	743-3		28-37	533-0	749-9		27-44	535-1	751-8		24-13	536-5	751-4			
30		26-42	529-1	743-8		28-54	532-6	749-7		27-80	537-3	749-2		24-47	536-1	752-6			
35		24-99	531-0	743-6		28-70	534-2	750-5		27-22	533-5	750-0		24-67	536-1	752-8			
40		25-95	530-3	743-4		28-64	535-2	748-8		27-24	534-5	750-1		25-14	536-1	751-5			
45		25-66	529-6	744-6		28-64	536-3	749-1		27-27	535-2	750-8		25-27	536-0	751-6			
50		25-83	529-8	745-8		28-77	536-4	748-5		26-97	534-8	749-8		25-21	535-7	751-4			
55		25-56	529-9	744-9		28-70	536-1	748-6		27-02	534-7	750-4		23-19	535-9	748-1			
Hour,			18	19	20	21	22	23	0	1	2	3	4	5	6	7	8	9	10
BIFILAR THERMOMETER, .			53-4	53-9	53-8	53-2	53-0	53-0	52-9	52-8	53-1	52-9	52-4	52-1	51-3	51-5	52-2	52-8	53-0
BALANCE THERMOMETER, .			55-8	55-8	55-8	55-2	55-0	55-1	54-9	54-8	54-9	54-5	54-0	53-8	53-0	53-1	53-8	54-4	54-7
OBSERVER'S INITIAL, . . .			II	H	H	H	B	B	B	B	II	II	W	W	D	D	B	B	
			BIFILAR. $k=0.0001248$.					Observed 2 ^m after the Declination.											
			BALANCE. $k=0.000015$ approximately.					Observed 3 ^m after the Declination.											
February Term. For observations before and after this Term, see <i>Extra Observations</i> .																			

MARCH 22, 23.

Göttingen Mean Time of Declination Observation.	MARCH 22, 23.																		
	DECLINATION.			BIFILAR Corrected.			BALANCE Corrected.			DECLINATION.			BIFILAR Corrected.			BALANCE Corrected.			
	°	'	Sec. Div.	Mic. Div.	°	'	Sec. Div.	Mic. Div.	°	'	Sec. Div.	Mic. Div.	°	'	Sec. Div.	Mic. Div.	°	'	Sec. Div.
	10 ^h .			14 ^h .			18 ^h .			22 ^h .									
0	25	20-87	548-0	724-4	25	22-03	545-9	620-7	25	23-16	543-1	682-1	25	24-04	530-6	690-8			
5		21-29	544-8	725-7		20-82	541-0	624-7		22-83	545-7	681-3		23-97	532-9	689-8			
10		21-88	544-2	723-8		20-07	539-3	628-1		25-75	539-6	685-9		23-59	532-8	689-8			
15		22-52	542-8	722-1		19-61	538-5	631-9		24-71	542-8	685-2		24-15	533-4	689-0			
20		23-36	542-4	721-7		18-97	536-3	635-5		23-90	544-2	683-1		23-56	531-0	688-7			
25		24-15	540-5	721-2		18-92	534-7	638-9		23-41	544-2	683-4		24-24	533-7	688-7			
30		24-03	539-5	720-8		18-87	533-4	640-8		23-24	543-3	684-5		24-44	534-4	688-2			
35		23-81	540-2	717-7		18-25	533-6	640-8		23-03	543-5	684-1		24-15	534-3	688-3			
40		23-64	541-4	715-6		17-17	535-0	640-5		22-67	542-3	685-1		24-47	533-6	688-1			
45		23-29	541-3	714-8		16-44	536-4	641-7		23-12	541-9	685-3		24-01	533-2	688-0			
50		23-26	540-0	712-8		15-70	535-7	642-5		23-04	542-1	685-3		24-48	533-9	688-0			
55		23-32	538-9	711-9		15-79	536-7	642-1		23-53	540-9	687-5		24-98	533-9	688-0			
	11 ^h .			15 ^h .			19 ^h .			23 ^h .									
0	25	23-17	538-9	709-9	25	15-69	535-0	641-9	25	23-07	540-1	689-6	25	25-14	534-2	688-0			
5		23-29	540-8	709-2		16-92	533-3	647-8		23-93	538-8	689-4		25-68	533-6	688-0			
10		23-36	539-9	709-7		19-00	530-7	654-1		23-93	538-0	690-1		25-95	532-8	688-0			
15		23-44	539-7	710-9		20-43	528-4	654-9		23-39	538-2	689-7		25-95	533-2	688-0			
20		23-53	538-4	711-2		20-50	529-4	658-6		23-56	538-5	690-0		26-01	532-2	689-3			
25		23-50	538-3	711-6		21-73	530-4	659-5		23-30	538-9	689-2		26-48	532-9	689-3			
30		23-97	539-1	710-2		21-91	531-6	659-2		23-19	540-9	689-6		26-80	531-9	689-3			
35		24-33	548-5	704-5		22-65	531-6	660-7		23-86	540-4	690-0		27-13	531-4	689-3			
40		24-65	555-7	699-0		22-90	533-6	664-0		23-76	540-1	689-8		27-60	533-3	689-3			
45		24-40	557-8	694-6		23-23	535-1	661-9		23-93	542-3	689-5		27-80	531-6	689-3			
50		23-12	553-5	693-8		23-43	537-1	662-3		23-79	542-6	689-3		27-88	531-1	689-3			
55		21-26	552-9	690-6		23-29	537-1	664-0		24-13	543-1	689-0		27-61	531-9	689-3			
	12 ^h .			16 ^h .			20 ^h .			0 ^h .									
0	25	20-40	551-6	688-9	25	23-12	536-4	663-9	25	24-60	544-2	690-0	25	28-07	531-3	689-3			
5		20-40	546-2	688-8		22-74	538-8	663-0		24-57	542-6	690-7		28-74	533-7	689-3			
10		19-96	541-1	690-5		22-92	538-9	665-4		24-87	543-9	690-5		28-82	530-9	686-9			
15		19-93	537-1	693-6		23-29	539-6	666-2		24-53	540-7	691-3		29-35	529-7	687-3			
20		19-91	536-2	693-9		23-39	540-4	666-1		23-44	542-2	691-4		29-76	530-4	687-3			
25		20-28	535-6	697-6		23-97	538-8	669-4		24-53	538-4	694-4		29-65	532-0	687-3			
30		20-88	533-8	699-1		23-50	539-4	668-3		24-47	536-6	696-4		30-48	533-8	687-3			
35		21-07	533-7	700-3		23-54	538-9	668-2		23-70	536-0	696-4		32-31	538-1	686-9			
40		20-97	534-4	699-9		23-53	540-0	669-3		23-36	535-9	698-3		31-99	533-2	687-3			
45		21-48	533-9	699-9		23-83	540-8	671-6		23-39	533-1	697-6		31-68	532-8	687-3			
50		21-66	534-4	698-2		24-15	539-0	670-0		21-91	538-5	696-0		32-25	533-5	687-8			
55		25-05	530-1	698-5		23-48	538-0	671-4		23-39	540-0	695-3		31-64	531-4	689-1			
	13 ^h .			17 ^h .			21 ^h .			1 ^h .									
0	25	26-99	527-2	697-0	25	22-69	539-1	671-0	25	23-54	542-6	696-3	25	32-20	534-5	689-1			
5		26-77	527-7	692-0		22-77	538-2	671-6		24-33	536-4	696-3		33-07	534-5	694-0			
10		30-07	534-7	687-1		23-03	538-9	672-2		22-45	538-6	695-9		32-35	530-9	697-5			
15		32-31	545-0	675-9		23-19	538-5	673-6		23-76	536-8	693-8		31-63	529-3	696-0			
20		32-02	551-3	662-6		23-26	538-2	673-7		24-42	537-1	693-0		31-84	530-2	695-4			
25		31-25	559-3	652-5		23-44	537-7	677-5		24-98	537-9	694-3		31-68	531-5	695-8			
30		30-05	562-1	642-0		23-44	535-4	680-3		25-27	534-8	693-3		31-66	531-3	696-3			
35		29-29	562-8	634-7		22-42	537-9	678-7		24-48	534-9	694-5		31-32	530-0	695-5			
40		29-14	558-2	630-4		23-44	539-6	679-9		24-71	533-8	693-4		31-30	529-8	696-0			
45		28-00	558-3	625-5		25-21	535-6	682-2		24-44	533-2	692-3		31-38	529-7	696-2			
50		25-81	555-9	619-9		24-40	534-9	684-0		24-60	532-7	693-4		31-43	528-4	697-3			
55		23-44	551-0	613-7		21-73	540-1	682-7		23-97	531-0	690-6		31-43	531-2	697-0			

Hour,	10	11	12	13	14	15	16	17	18	19	20	21	22	23	0	1
BIFILAR THERMOMETER, . . .	56-0	54-0	54-0	54-0	53-9	53-9	53-8	53-5	53-3	53-3	53-0	52-5	52-2	52-3	52-3	52-5
BALANCE THERMOMETER, . . .	56-0	54-2	54-8	55-5	54-8	54-3	54-0	54-0	53-8	53-6	53-2	53-0	52-5	52-5	52-5	52-5
OBSERVER'S INITIAL,	W	W	W	W	W	W	W	B	B	B	B	B	D	D	D	D

BIFILAR. Observed 2^m after the Declination. $k=0.0001248$.
 BALANCE. Observed 3^m after the Declination. $k=0.000015$ approximately.

Göttingen Mean Time of Declination Observation.	MARCH 22, 23.						APRIL, 19, 20.											
	DECLINATION.		BIFILAR Corrected.		BALANCE Corrected.		DECLINATION.		BIFILAR Corrected.		BALANCE Corrected.							
	°	'	Sec. Div.	Mic. Div.	°	'	Sec. Div.	Mic. Div.	°	'	Sec. Div.	Mic. Div.						
		2h.				6h.				10h.				14h.				
0	25	31-83	533-2	695-9	25	24-87	535-6	724-6	25	23-09	543-8	683-9	25	20-57	539-7	685-3		
5		31-99	535-6	695-3		24-11	530-8	728-0		23-24	543-9	684-2		20-52	539-9	684-7		
10		31-71	533-8	696-5		22-15	528-5	730-9		23-10	543-6	691-1		20-57	539-8	684-1		
15		31-86	535-0	694-9		21-28	536-9	732-8		23-03	543-8	690-8		20-45	539-7	683-5		
20		32-05	537-6	693-4		22-79	533-1	735-9		23-10	543-9	690-1		20-57	539-9	682-9		
25		31-93	535-4	694-8		22-49	531-9	739-3		23-03	543-0	691-0		20-70	539-7	682-3		
30		32-10	538-7	694-8		18-75	536-8	738-0		22-92	543-6	691-0		20-54	539-0	681-7		
35		31-79	535-7	695-7		13-44	542-5	737-2		23-06	544-1	691-7		20-57	538-9	681-2		
40		31-77	537-0	696-1		13-17	547-0	739-5		23-06	544-6	692-2		20-57	538-8	682-1		
45		31-48	540-9	694-2		15-36	544-7	739-9		22-85	544-7	„		20-43	538-7	682-5		
50		32-20	541-6	695-8		16-84	537-3	740-8		22-80	544-7	692-2		20-27	538-7	681-8		
55		31-61	540-2	697-9		16-80	538-8	737-5		22-72	544-3	„		20-45	538-6	682-2		
		3h.				7h.				11h.				15h.				
0	25	31-56	539-8	698-1	25	16-87	530-6	735-4	25	22-62	543-7	692-3	25	20-30	538-4	683-3		
5		31-16	539-9	697-7		13-82	547-3	726-0		22-83	544-1	„		20-57	538-1	683-9		
10		30-96	538-1	696-8		13-77	552-0	723-3		22-80	543-9	„		20-57	538-1	„		
15		30-56	538-1	697-0		15-76	552-4	723-6		22-62	543-1	„		20-57	539-0	„		
20		30-36	540-0	697-2		17-67	546-3	724-4		22-58	543-0	„		20-63	539-1	683-9		
25		30-39	540-7	697-7		18-86	544-0	724-6		22-67	543-0	„		20-43	538-0	684-4		
30		29-91	538-4	698-9		20-23	539-3	725-2		22-60	542-8	688-0		20-35	537-5	684-8		
35		29-91	540-2	698-4		20-57	540-9	721-2		22-58	542-8	„		20-43	537-9	681-4		
40		30-12	540-9	698-6		20-54	539-2	722-3		22-58	542-7	„		20-10	537-4	„		
45		29-88	541-4	698-8		21-28	538-1	725-3		22-58	542-7	„		20-03	536-9	678-8		
50		29-55	541-8	699-0		22-02	538-9	718-7		542-8	687-2		20-10	535-5	„		
55		29-31	542-1	699-7		22-63	539-3	719-0		22-62	542-5	„		20-43	533-0	„		
		4h.				8h.				12h.				16h.				
0	25	29-01	540-5	701-0	25	23-43	539-3	717-9	25	22-58	542-3	686-9	25	20-30	533-8	681-5		
5		29-19	544-8	700-7		24-13	538-5	717-5		22-52	541-8	„		19-96	534-9	„		
10		29-12	543-0	701-7		24-48	537-7	716-0		22-55	541-4	„		20-34	536-3	682-7		
15		30-53	542-7	699-9		25-14	536-0	716-0		22-47	541-4	„		21-17	534-1	682-8		
20		28-37	540-3	701-3		25-34	536-4	714-6		22-40	541-5	691-1		21-24	534-8	„		
25		27-83	536-7	701-5		25-16	536-8	713-2		22-32	541-5	„		21-17	534-8	„		
30		27-91	537-2	703-3		25-39	535-2	713-1		22-18	541-0	„		20-97	535-7	„		
35		27-70	538-3	703-3		25-68	534-7	713-1		22-20	540-5	„		20-90	535-7	„		
40		27-90	540-8	705-4		25-68	534-9	712-9		22-23	540-6	689-1		20-57	537-4	679-1		
45		28-23	539-4	704-9		25-81	535-6	712-9		22-25	540-8	„		21-10	536-7	679-7		
50		27-09	539-4	705-1		25-90	536-0	711-4		22-11	540-8	„		20-63	535-6	682-4		
55		26-97	537-2	704-8		25-86	536-8	710-1		22-23	540-8	„		21-17	535-4	„		
		5h.				9h.				13h.				17h.				
0	25	27-33	549-6	704-0	25	25-79	537-1	710-3	25	22-11	540-5	687-2	25	21-10	535-6	„		
5		27-41	545-1	712-3		25-95	537-5	709-4		22-08	540-3	686-9		21-17	536-1	„		
10		26-72	538-0	712-6		25-83	537-9	707-9		22-05	540-2	686-5		21-17	535-9	„		
15		26-48	537-0	710-5		25-75	537-8	708-4		22-29	539-7	686-2		20-87	536-9	„		
20		26-28	538-2	711-5		25-46	538-2	708-2		22-13	540-0	„		20-81	537-0	„		
25		26-32	536-5	714-2		25-18	537-9	706-8		21-95	540-0	„		20-63	536-9	679-8		
30		26-62	538-2	712-4		25-12	538-2	705-1		22-02	540-3	687-8		20-77	537-5	680-8		
35		26-55	540-5	711-9		25-18	538-0	704-7		20-70	540-3	„		20-87	536-6	681-2		
40		26-72	545-2	713-3		25-05	538-0	704-2		20-61	540-3	687-1		21-37	534-9	„		
45		27-11	544-9	714-4		24-77	536-9	704-0		20-57	540-2	686-8		21-51	534-6	„		
50		26-15	540-5	714-2		25-02	538-1	703-5		20-95	540-1	686-5		21-44	533-6	„		
55		25-75	541-1	719-0		24-67	537-0	703-3		20-70	539-5	685-6		20-79	534-3	„		
Hour,		2	3	4	5	6	7	8	9	10	10	11	12	13	14	15	16	17
BIFILAR THERMOMETER, .		53-2	54-6	54-4	54-4	54-2	54-4	54-3	54-0	53-7	58-7	58-5	58-0	57-2	56-8	56-0	55-5	54-6
BALANCE THERMOMETER,		53-4	53-9	54-2	54-5	54-5	54-2	54-3	54-3	54-0	58-5	58-5	58-2	58-0	57-5	56-6	56-0	55-4
OBSERVER'S INITIAL, . .		W	W	II	II	B	B	D	D		II	II	H	II	D	B	B	B
<p>BIFILAR. Observed 2^m after the Declination. $k=0.0001248$. BALANCE. Observed 3^m after the Declination. $k=0.000015$ approximately.</p>																		
<p>April 19d 13h. When double commas (,) occur in the column for the Balance Magnetometer, the needle was examined, and no change from the previous observation being appreciable, the Micrometers were not altered. It should be remarked that the permanent observers possess the power of detecting slight changes with more facility than the occasional or Term assistants.</p>																		

APRIL 19, 20.

Göttingen Mean Time of Declination Observation.	DECLINATION.			DECLINATION.			DECLINATION.			DECLINATION.		
	DECLINATION.	BIFILAR Corrected.	BALANCE Corrected.	DECLINATION.	BIFILAR Corrected.	BALANCE Corrected.	DECLINATION.	BIFILAR Corrected.	BALANCE Corrected.	DECLINATION.	BIFILAR Corrected.	BALANCE Corrected.
Min.	° ' "	Sec. Div.	Mic. Div.	° ' "	Sec. Div.	Mic. Div.	° ' "	Sec. Div.	Mic. Div.	° ' "	Sec. Div.	Mic. Div.
	18h.			22h.			2h.			6h.		
0	25 21-24	533-9	677-7	25 19-71	530-6	25 28-81	534-2	669-7	25 22-49	545-5	696-6
5	21-32	533-5	677-0	19-94	529-8	686-7	28-64	533-8	„	21-79	544-5	696-5
10	21-01	533-9	676-3	19-93	529-5	688-2	28-72	534-2	„	21-91	547-3	696-5
15	21-10	535-1	675-6	19-93	526-9	685-8	29-28	533-6	672-6	21-64	546-4	„
20	21-17	535-0	674-9	20-58	528-0	685-3	28-84	534-7	674-5	21-21	545-1	„
25	21-53	535-2	674-2	20-63	528-5	685-4	28-70	533-7	678-6	20-37	545-3	„
30	21-79	535-2	674-2	20-54	528-6	686-8	28-89	531-0	676-0	19-83	545-8	699-9
35	21-98	536-2	673-5	20-81	527-6	687-5	28-07	531-0	„	19-61	547-9	699-8
40	22-38	536-2	672-8	20-13	528-8	687-7	28-17	533-3	„	19-49	549-4	700-6
45	21-89	536-1	„	21-31	527-9	688-3	28-07	533-6	681-9	19-89	549-3	700-5
50	21-66	536-3	„	21-61	526-6	„	27-78	532-7	„	20-57	549-2	„
55	21-31	536-0	„	21-91	526-9	688-8	27-74	533-7	„	21-01	547-6	700-3
	19h.			23h.			3h.			7h.		
0	25 21-14	535-6	669-8	25 21-75	525-7	686-6	25 27-41	534-3	684-0	25 21-37	549-0	700-3
5	21-10	535-8	672-1	21-91	525-5	687-1	27-26	533-6	685-4	21-15	545-3	„
10	20-38	536-8	671-7	22-80	525-8	687-7	27-06	536-8	„	20-28	543-9	„
15	20-27	536-9	673-6	22-58	526-8	„	26-72	538-0	„	19-70	545-0	„
20	19-86	537-8	673-2	23-16	525-9	687-7	26-69	537-9	„	19-61	546-5	„
25	19-46	538-0	672-8	23-26	524-5	„	26-05	537-4	„	19-36	547-0	„
30	19-22	537-8	672-4	23-61	524-6	687-9	25-85	537-7	„	19-67	546-0	„
35	19-15	538-2	675-7	23-86	524-5	„	26-37	538-0	688-4	20-18	546-8	„
40	18-92	538-8	675-3	24-44	524-2	686-0	25-88	536-9	689-3	20-84	546-1	„
45	18-68	538-0	674-9	25-09	525-3	„	26-25	539-8	„	21-21	544-3	„
50	18-66	537-5	676-5	25-16	524-6	„	25-21	535-6	690-8	21-19	545-7	700-6
55	18-63	538-9	676-1	25-22	525-2	686-0	25-85	539-1	691-6	21-79	544-9	„
	20h.			0h.			4h.			8h.		
0	25 18-59	538-5	675-7	25 25-52	527-4	684-3	25 25-41	540-6	„	25 21-41	546-3	„
5	18-62	538-4	676-7	26-08	527-3	684-2	25-54	542-0	691-0	21-59	546-5	699-6
10	18-46	538-3	676-7	26-82	525-1	„	25-41	540-6	693-2	21-35	547-3	699-8
15	18-63	538-5	679-6	26-55	523-6	„	25-27	538-2	693-4	547-1	697-8
20	18-35	538-0	679-1	26-42	527-9	683-8	25-41	538-6	693-6	20-61	547-5	694-6
25	18-45	537-8	682-5	26-80	526-3	„	25-07	539-2	„	20-63	548-2	694-8
30	18-50	538-1	678-4	27-07	525-2	683-1	24-67	538-9	„	20-54	545-9	694-9
35	18-33	537-8	679-0	26-97	525-0	„	24-67	540-0	„	20-94	544-9	„
40	18-59	537-5	679-0	26-82	523-7	„	24-67	539-4	694-2	20-99	543-7	695-6
45	19-89	539-0	679-0	26-97	524-4	„	24-82	539-8	696-6	20-97	543-1	695-7
50	21-02	538-2	679-0	27-16	526-7	680-5	24-51	540-0	698-2	21-05	543-6	698-7
55	22-25	533-8	681-7	27-04	527-4	„	24-60	540-2	698-2	21-17	543-6	698-5
	21h.			1h.			5h.			9h.		
0	25 20-77	534-6	681-2	25 27-20	528-9	678-0	25 24-27	539-6	698-2	25 21-24	543-6	698-8
5	21-46	535-7	„	26-53	531-3	675-1	24-27	541-3	„	21-31	545-2	„
10	21-28	532-4	„	27-54	529-6	676-5	23-93	541-5	„	21-37	543-6	„
15	18-79	534-2	682-3	27-41	528-7	674-8	23-91	540-0	„	21-31	544-1	696-8
20	18-86	534-4	„	27-47	531-2	672-6	23-73	540-8	698-6	21-31	545-5	695-4
25	19-10	534-2	681-3	27-80	531-0	„	23-29	540-9	„	21-31	544-9	694-4
30	19-09	533-2	685-0	27-56	526-7	„	23-24	539-7	„	21-35	545-2	„
35	19-22	532-6	„	28-23	527-9	„	23-46	543-7	„	21-31	544-6	„
40	19-63	531-6	„	28-84	529-5	671-6	22-92	543-3	697-4	21-69	544-3	„
45	19-58	529-1	682-1	28-75	530-0	„	23-06	543-7	697-2	21-37	543-8	„
50	19-67	530-4	682-4	28-34	530-4	„	22-92	543-4	697-0	21-42	544-8	„
55	19-34	530-3	680-3	28-54	531-6	„	22-76	542-8	696-8	21-64	544-6	694-8

Hour,	18	19	20	21	22	23	0	1	2	3	4	5	6	7	8	9	10
BIFILAR THERMOMETER, .	53-8	52-8	52-2	52-2	52-7	53-8	54-8	55-7	56-1	56-2	56-3	56-3	56-0	55-9	55-6	55-6	55-6
BALANCE THERMOMETER, .	54-5	53-4	52-8	52-8	53-0	54-0	54-8	55-4	55-6	56-0	56-0	56-0	55-7	55-6	55-5	55-7	55-9
OBSERVER'S INITIAL, . .	D	D	D	H	W	W	W	W	H	B	B	Var.	D	D	D	W	

BIFILAR. Observed 2^m after the Declination. $k=0.0001248$.
 BALANCE. Observed 3^m after the Declination. $k=0.000015$ approximately.

Göttingen Mean Time of Declination Observation.		MAY 26, 27.																	
		DECLINA- TION.	BIFILAR Corrected.	BALANCE Corrected.	DECLINA- TION.	BIFILAR Corrected.	BALANCE Corrected.	DECLINA- TION.	BIFILAR Corrected.	BALANCE Corrected.	DECLINA- TION.	BIFILAR Corrected.	BALANCE Corrected.						
Min.	° ' "	Sc. Div.	Mic. Div.	° ' "	Sc. Div.	Mic. Div.	° ' "	Sc. Div.	Mic. Div.	° ' "	Sc. Div.	Mic. Div.							
		10 ^h .			14 ^h .			18 ^h .			22 ^h .								
0	25 17-61	473.2	578.3	25 9-00	491.4	599.0	25 17-04	504.3	649.9	25 20-67	478.5	656.5							
5	12-23	482.0	569.1	9-27	492.2	599.0	17-04	504.5	651.5	21-14	479.3	654.0							
10	9-40	500.1	577.1	10-29	490.7	600.3	16-95	504.1	652.3	21-34	477.4	"							
15	7-24	514.5	589.1	10-88	490.1	606.3	17-20	503.8	654.1	21-49	478.8	653.1							
20	7-85	519.0	592.0	11-15	493.5	606.3	16-84	503.0	654.8	21-31	480.3	"							
25	9-00	518.6	593.2	11-96	492.9	607.5	16-70	502.6	654.8	23-79	474.6	658.9							
30	10-72	522.3	600.2	12-94	493.8	607.5	16-78	502.7	655.8	23-81	472.7	657.7							
35	13-51	520.1	610.2	13-46	496.4	613.7	17-39	501.3	656.4	23-21	476.5	653.5							
40	15-83	512.5	621.5	15-09	497.0	616.2	16-91	501.1	"	23-41	477.8	"							
45	17-74	506.9	628.4	15-43	499.8	617.7	16-31	500.0	658.0	23-64	477.8	646.7							
50	18-73	498.4	634.2	15-90	502.8	622.1	16-58	500.3	658.6	23-91	478.3	"							
55	18-65	495.6	639.2	16-53	505.2	"	17-02	499.6	"	24-20	479.9	"							
		11 ^h .			15 ^h .			19 ^h .			23 ^h .								
0	25 18-41	500.3	638.2	25 17-07	503.7	"	25 17-79	498.2	658.8	25 24-60	479.7	647.5							
5	18-38	506.0	640.1	16-70	507.5	"	17-02	497.3	660.9	24-77	481.4	"							
10	19-12	510.9	638.5	15-86	511.4	"	16-67	497.3	"	25-29	481.5	645.0							
15	19-93	515.0	638.6	15-84	512.1	619.8	16-46	497.1	"	25-38	483.4	"							
20	20-41	516.6	637.8	15-86	511.0	"	16-53	496.6	"	25-61	485.3	643.2							
25	21-01	517.2	636.0	15-56	510.1	"	16-91	496.1	"	25-96	485.7	642.2							
30	19-96	515.1	634.3	15-14	509.2	"	17-14	495.7	"	26-42	486.4	641.4							
35	19-89	515.6	631.9	15-19	509.7	"	16-91	494.4	660.8	26-43	486.9	"							
40	20-03	514.3	631.8	15-30	509.2	"	16-48	493.4	"	26-77	484.4	"							
45	20-20	511.0	631.6	15-56	508.7	621.7	16-55	493.3	659.7	27-17	485.8	"							
50	18-99	512.2	629.7	15-86	507.2	623.8	16-57	492.6	"	27-33	485.4	"							
55	18-13	514.4	628.8	15-43	506.9	"	16-60	491.0	"	27-54	486.8	"							
		12 ^h .			16 ^h .			20 ^h .			0 ^h .								
0	25 17-98	512.8	629.2	25 15-29	508.5	"	25 16-41	490.8	661.1	25 27-76	489.1	641.3							
5	17-98	509.8	629.5	15-66	511.0	628.6	16-57	490.1	"	27-90	490.6	"							
10	17-91	510.0	627.7	17-83	510.1	"	16-71	489.2	663.5	28-18	491.7	"							
15	17-45	514.9	621.7	18-41	509.1	631.1	16-98	488.2	664.3	28-34	492.6	"							
20	15-93	519.7	613.6	18-41	509.0	631.9	17-29	486.6	665.7	28-44	492.0	637.3							
25	15-09	514.1	610.1	17-88	509.3	635.8	17-14	486.6	666.6	28-50	493.4	"							
30	13-17	509.6	606.3	18-28	509.9	"	16-97	486.7	"	28-70	494.3	635.2							
35	12-72	499.4	607.8	18-25	508.7	640.6	17-07	486.0	668.4	28-88	495.9	"							
40	10-72	502.1	605.8	18-03	508.6	641.2	17-91	485.9	671.2	29-11	495.7	"							
45	11-73	500.6	604.4	17-98	508.1	643.1	17-88	482.7	"	29-15	495.7	633.7							
50	12-50	495.0	604.6	18-01	508.6	"	17-14	483.8	668.2	29-17	497.0	"							
55	11-96	495.1	599.0	18-55	506.5	644.8	17-54	483.2	"	29-31	497.0	"							
		13 ^h .			17 ^h .			21 ^h .			1 ^h .								
0	25 11-69	493.3	594.1	25 17-78	506.5	645.3	25 17-71	482.6	668.4	25 29-29	497.2	633.2							
5	10-55	490.1	593.1	17-98	507.3	"	17-83	482.9	668.1	29-31	498.0	"							
10	9-87	486.0	"	18-01	507.3	"	18-21	481.8	"	29-31	497.9	"							
15	9-40	486.0	"	17-86	507.0	645.2	18-53	482.1	666.6	29-36	501.1	633.8							
20	9-81	486.7	601.0	17-39	508.1	646.0	18-55	481.9	"	29-56	502.9	"							
25	10-11	488.9	595.7	18-06	507.9	647.1	18-55	482.1	663.6	29-65	503.0	"							
30	10-11	488.1	593.4	18-06	506.9	649.3	18-70	480.7	661.2	29-73	505.1	638.2							
35	9-67	488.6	593.8	17-88	506.1	"	19-13	480.3	660.6	29-78	500.0	"							
40	9-34	487.2	591.5	17-31	506.7	"	19-44	480.4	659.8	29-68	502.8	"							
45	8-57	487.9	593.1	17-34	505.0	"	19-39	478.5	658.8	29-68	503.0	643.1							
50	9-00	487.9	595.6	17-15	505.7	649.6	19-78	477.0	660.2	29-75	504.0	"							
55	9-24	489.1	599.0	16-84	505.9	650.3	21-12	476.2	659.2	29-89	505.3	"							
Hour,		10	11	12	13	14	15	16	17	18	19	20	21	22	23	0	1	2	
BIFILAR THERMOMETER, .		55.9	55.9	55.9	55.8	55.7	55.4	55.2	55.0	54.4	54.0	53.8	53.7	53.8	54.2	54.9	55.2	55.3	
BALANCE THERMOMETER,		55.5	55.6	55.6	55.6	55.5	55.5	55.3	55.0	54.4	54.4	54.0	54.0	54.0	54.5	54.9	55.0	55.4	
OBSERVER'S INITIAL, . .		B	B	B	B	D	D	D	D	W	W	W	W	W	W	W	W	W	
BIFILAR. Observed 2 ^m after the Declination. $k=0.0001205$.																			
BALANCE. Observed 3 ^m after the Declination. $k=0.000015$ approximately.																			
May 27 ^d 1 ^h 30 ^m . Clock error previously + 14 ^s . Clock set right.																			

Göttingen Mean Time of Declination Observation.	MAY 26, 27.						JUNE 21, 22.					
	DECLINA- TION.	BIFILAR Corrected.	BALANCE Corrected.	DECLINA- TION.	BIFILAR Corrected.	BALANCE Corrected.	DECLINA- TION.	BIFILAR Corrected.	BALANCE Corrected.	DECLINA- TION.	BIFILAR Corrected.	BALANCE Corrected.
	°	Sec. Div.	Mic. Div.	°	Sec. Div.	Mic. Div.	°	Sec. Div.	Mic. Div.	°	Sec. Div.	Mic. Div.
	2h.			6h.			10h.			14h.		
0	25 29-98	504.5	644.8	25 23-91	514.5	670.2	25 20-57	512.8	668.0	25 25-27	499.9	656.1
5	29-91	505.2	645.8	23-93	514.7	673.1	20-97	511.5	"	25-38	499.7	657.7
10	29-82	504.0	649.8	24-00	515.5	674.4	21-22	510.9	666.3	25-27	499.9	657.3
15	29-85	502.9	650.4	23-86	512.4	673.6	21-37	511.0	"	25-27	499.4	658.4
20	29-62	501.3	651.4	23-53	510.6	674.5	21-37	508.9	666.9	25-41	500.1	660.3
25	29-51	501.2	654.2	23-43	510.9	"	21-78	509.8	"	25-43	500.9	656.7
30	29-44	503.5	648.0	23-26	510.2	"	22-02	510.0	"	25-79	499.3	657.5
35	29-63	507.4	653.0	23-04	510.9	"	21-98	509.7	664.6	26-43	498.0	657.9
40	29-44	509.9	"	23-26	512.4	"	21-95	508.4	"	26-50	498.9	657.3
45	29-31	511.4	654.6	23-36	513.9	672.5	22-03	507.9	"	26-42	499.9	655.8
50	29-31	509.7	657.4	23-53	515.4	"	22-16	507.1	"	26-25	500.1	657.9
55	28-94	507.1	"	23-53	513.5	"	22-56	504.4	664.0	26-10	500.2	656.6
	3h.			7h.			11h.			15h.		
0	25 28-65	512.4	"	25 23-26	512.7	674.1	25 22-72	504.1	664.1	25 26-12	500.9	657.8
5	28-67	508.5	660.0	23-14	510.4	"	23-06	505.8	"	25-98	501.8	658.3
10	28-64	509.7	660.8	23-12	510.7	"	22-72	506.5	"	25-95	502.6	657.6
15	28-59	512.0	"	23-26	511.7	673.0	23-12	506.8	"	25-92	502.4	657.8
20	28-64	513.6	661.4	23-12	512.9	"	23-19	505.1	"	25-72	501.7	659.2
25	28-64	509.6	663.3	23-12	512.7	"	22-72	504.6	"	25-65	501.0	659.3
30	27-96	505.0	666.0	23-12	512.2	672.6	23-12	506.0	"	25-31	500.8	659.6
35	27-83	505.9	"	22-99	512.4	671.6	22-87	505.6	"	25-27	501.3	661.3
40	27-83	505.8	665.6	22-72	512.0	673.1	23-19	505.7	"	25-27	501.5	662.3
45	27-47	505.3	667.1	22-74	512.0	673.3	*27-63	505.5	659.8	25-18	502.0	661.6
50	27-29	510.9	664.3	22-65	512.4	"	27-49	504.1	"	25-16	502.5	661.0
55	27-61	517.3	664.8	22-65	511.4	"	27-60	504.3	"			
	4h.			8h.			12h.			16h.		
0	25 27-43	514.8	663.4	25 22-65	514.1	671.8	25 27-83	505.0	656.8	25 25-02	502.9	659.2
5	27-80	514.5	"	23-17	514.0	"	27-83	505.6	"	24-96	503.0	656.8
10	27-31	514.1	"	23-26	515.0	"	27-47	504.5	"	25-01	502.5	657.9
15	26-84	512.6	"	23-26	515.9	670.8	27-29	503.6	"	24-62	502.7	657.0
20	26-94	512.4	664.9	22-49	512.7	"	27-02	503.3	"	24-57	502.9	657.3
25	26-52	509.4	"	21-98	512.3	"	26-48	502.9	"	24-60	502.3	658.8
30	26-30	508.9	"	21-78	512.6	673.2	26-15	502.5	654.8	24-74	501.9	660.0
35	26-22	508.3	669.8	21-91	511.5	"	26-32	503.4	"	24-64	501.7	660.4
40	25-98	508.4	"	21-24	509.5	"	26-08	502.9	"	24-40	502.1	659.3
45	25-95	510.1	"	21-14	511.1	675.5	26-48	502.3	"	24-20	502.3	659.3
50	25-81	509.5	"	21-24	511.4	"	26-22	502.1	"	23-93	502.5	659.2
55	25-48	510.1	673.0	21-44	513.3	"	26-08	502.5	"	24-08	501.3	659.5
	5h.			9h.			13h.			17h.		
0	25 25-39	510.7	"	25 22-38	513.4	674.5	25 25-85	502.6	"	25 24-03	500.8	658.7
5	25-27	511.3	"	22-65	512.1	"	25-95	501.4	"	24-06	500.3	659.1
10	25-14	511.4	"	21-84	510.9	"	25-85	500.6	"	24-15	499.1	659.0
15	24-94	512.6	"	21-76	511.6	674.8	25-56	500.5	655.8	24-27	499.2	660.4
20	24-74	512.9	"	21-34	512.5	"	25-27	501.6	"	24-35	499.8	659.5
25	24-47	511.4	"	21-24	513.9	"	25-27	501.5	"	23-98	499.2	660.1
30	24-06	509.9	673.2	21-55	514.3	672.9	25-27	501.2	"	23-79	498.6	660.7
35	23-88	510.4	"	21-69	513.4	"	25-27	500.5	658.1	23-36	499.0	660.5
40	24-47	515.1	673.7	21-62	512.0	"	25-27	499.8	"	23-32	498.4	662.5
45	24-64	520.9	671.2	21-84	511.0	674.8	25-41	499.3	"	23-30	498.1	660.8
50	24-47	519.2	"	21-95	509.7	"	25-27	499.9	"	23-17	498.1	660.6
55	24-17	516.3	"	21-98	508.3	"	25-27	499.9	"	23-19	497.3	661.1

Hour,	2	3	4	5	6	7	8	9	10	10	11	12	13	14	15	16	17
BIFILAR THERMOMETER, .	55.3	55.7	55.7	55.9	56.6	56.6	56.3	55.8	55.7	65.7	65.0	64.0	63.4	63.0	62.1	61.4	60.6
BALANCE THERMOMETER, .	55.4	55.4	55.5	55.8	56.2	56.2	56.0	55.9	55.8	64.8	64.3	63.7	63.2	62.7	62.5	61.9	61.0
OBSERVER'S INITIAL, . .	B	B	D	D	W	W	H	H		D	D	D	D	W	W	W	W

BIFILAR. Observed 2^m after the Declination. $k=0.0001205$.
 BALANCE. Observed 3^m after the Declination. $k=0.000015$ approximately.

* June 21^d. See note, page 38, on the Declination Observations.

Göttingen Mean Time of Declination Observation.	JUNE 21, 22.																			
	DECLINATION.			BIFILAR Corrected.			BALANCE Corrected.			DECLINATION.			BIFILAR Corrected.			BALANCE Corrected.				
	Min.	°	'	Sec. Div.	Mic. Div.	°	'	Sec. Div.	Mic. Div.	°	'	Sec. Div.	Mic. Div.	°	'	Sec. Div.	Mic. Div.			
			18 ^h .					22 ^h .									6 ^h .			
0	25	23-14	497-1	663-7	500-5	660-0	504-3	641-6	514-5	651-2							
5		22-92	497-8	662-0	500-4	660-3	503-9	642-2	514-6	..							
10		22-72	498-2	663-2	500-4	661-6	503-2	641-9	514-1	..							
15		22-50	498-4	663-5	501-3	661-4	502-2	643-1	514-7	652-6							
20		22-63	497-2	501-6	661-8	502-7	645-6	514-8	..							
25		22-55	497-7	501-7	503-6	643-0	515-8	..							
30		22-49	497-3	663-6	501-9	662-0	504-9	642-8	516-3	..							
35		22-38	496-9	501-8	505-3	642-7	516-9	..							
40		21-86	496-5	501-8	504-7	645-6	517-0	..							
45		21-73	495-8	665-3	502-1	504-1	645-5	516-9	..							
50		21-89	495-7	501-2	664-3	503-5	646-6	516-7	..							
55		21-62	494-5	500-9	503-9	646-3	517-4	..							
			19 ^h .					23 ^h .									7 ^h .			
0	25	21-79	494-4	665-9	501-1	664-1	503-9	646-4	517-7	654-9							
5		22-53	495-9	500-1	503-3	647-3	517-4	..							
10		22-60	496-4	500-3	662-7	502-8	645-9	517-8	..							
15		22-76	497-4	664-8	500-0	660-6	501-8	644-9	517-4	..							
20		22-90	496-5	499-3	658-5	502-5	643-6	517-1	..							
25		23-14	496-1	499-4	657-0	502-9	642-7	517-7	..							
30		23-19	496-1	665-2	499-8	654-7	503-2	642-3	516-5	..							
35		23-64	496-1	499-9	652-8	503-1	642-4	516-0	..							
40		23-81	495-3	499-2	649-6	502-7	642-7	515-3	..							
45		23-34	495-1	666-4	498-7	646-6	501-7	642-7	516-1	..							
50		23-90	496-1	498-1	646-1	502-2	642-1	516-2	..							
55		24-28	497-5	667-2	498-3	643-5	503-5	640-7	516-5	..							
			20 ^h .					0 ^h .									8 ^h .			
0	25	24-44	496-3	665-7	499-0	639-0	503-7	643-7	515-3	657-4							
5		24-62	495-9	666-0	500-2	638-1	504-0	516-0	..							
10		24-77	495-9	500-7	638-2	504-6	515-7	658-2							
15		24-87	496-6	671-9	501-6	637-2	505-6	642-5	515-2	658-9							
20		25-02	497-4	501-3	638-2	506-0	514-3	660-3							
25		25-11	496-7	502-2	637-6	506-4	514-0	660-5							
30		25-21	497-5	670-8	502-4	637-2	506-9	644-3	514-4	661-7							
35		25-27	498-4	502-6	637-3	507-5	514-1	662-1							
40		25-34	498-4	666-8	502-6	508-5	513-8	661-7							
45		25-27	497-4	664-3	502-6	508-4	643-3	513-6	662-2							
50		25-72	499-4	502-4	508-4	512-9	..							
55		25-41	497-7	503-2	510-1	512-9	662-8							
			21 ^h .					1 ^h .									9 ^h .			
0	25	25-43	499-6	663-1	502-5	509-5	643-8	511-9	..							
5		25-56	499-1	502-7	510-5	511-8	662-9							
10		25-51	499-0	502-7	640-8	510-7	510-8	..							
15		25-81	499-1	663-1	503-6	639-8	511-1	643-0	510-4	..							
20		25-95	499-6	504-7	638-0	512-9	511-0	662-2							
25		25-95	498-9	504-9	639-7	513-8	511-8	..							
30		26-10	499-8	661-1	504-4	640-2	513-5	648-5	511-3	..							
35		26-08	499-8	504-5	639-4	513-2	510-8	..							
40		26-03	499-9	504-4	639-2	512-7	510-5	..							
45		25-95	500-7	660-2	503-7	641-0	512-8	649-4	510-1	..							
50		26-22	500-9	506-2	644-9	514-3	509-7	..							
55		26-25	500-8	504-7	514-9	509-9	656-5							
Hour,				18	19	20	21	22	23	0	1	2	3	4	5	6	7	8	9	10
BIFILAR THERMOMETER, .				59-9	59-5	59-7	60-1	61-1	62-0	63-2	64-3	65-8	67-0	68-0	69-0	69-9	70-7	71-0	70-8	69-7
BALANCE THERMOMETER, .				60-2	60-0	60-1	60-5	61-0	62-0	62-6	64-0	64-8	65-8	66-9	67-5	68-4	68-8	69-3	69-6	68-4
OBSERVER'S INITIAL, . . .				II	II	II	II	B	B	B	B	W	W	H	II	D	D	B	B	
BIFILAR. Observed 2 ^m after the Declination. $k=0.0001205$.																				
BALANCE. Observed 3 ^m after the Declination. $k=0.000015$ approximately.																				
<p>June 22^d 9^h 5^m. Discovered several fibres of the Declination suspension thread broken, and, on removing the box cover, the stirrup of the magnet was found resting on the copper ring. The observations of Declination are not given after 21^d 22^h, as the fibres were probably breaking throughout the day; the observations after 22^h are probably affected by a considerable torsion force.</p>																				

Göttingen Mean Time of Declination Observation.	JULY 19, 20.																							
	DECLINATION.			BIFILAR Corrected.			BALANCE Corrected.			DECLINATION.			BIFILAR Corrected.			BALANCE Corrected.								
	°	'	Sec. Div.	Mic. Div.	°	'	Sec. Div.	Mic. Div.	°	'	Sec. Div.	Mic. Div.	°	'	Sec. Div.	Mic. Div.	°	'	Sec. Div.	Mic. Div.				
	10 ^h .						14 ^h .						18 ^h .						22 ^h .					
0	25	20-88	506-9	654-6	25	21-86	506-1	649-0	25	18-48	500-9	647-1	25	20-72	490-7	652-0								
5		20-77	507-7	"		21-84	506-0	648-5		18-55	499-7	648-4		20-57	491-7	"								
10		20-94	508-6	655-0		21-78	506-6	"		18-10	500-1	"		20-57	492-3	"								
15		21-12	509-0	"		22-32	507-2	649-8		18-38	500-9	"		20-65	492-7	647-7								
20		21-41	509-7	"		22-45	506-4	"		18-55	500-6	"		21-17	492-9	"								
25		21-73	509-2	"		22-38	506-2	"		18-12	500-7	"		21-44	492-5	"								
30		21-73	509-3	"		22-15	505-8	647-6		18-38	500-9	"		21-89	491-7	"								
35		21-88	509-4	"		21-88	505-4	"		18-41	500-3	647-5		22-09	491-7	647-9								
40		21-84	509-3	653-6		21-84	505-7	"		18-06	499-8	"		22-53	492-0	"								
45		21-69	508-6	"		22-00	505-5	646-7		18-05	499-9	647-9		22-76	491-9	"								
50		21-68	508-8	"		21-75	504-0	"		17-89	499-3	649-0		22-79	491-4	"								
55		21-78	509-2	"		21-53	503-8	"		17-88	499-4	648-6		23-14	490-2	"								
	11 ^h .						15 ^h .						19 ^h .						23 ^h .					
0	25	22-05	509-9	"	25	21-64	504-3	648-0	25	17-61	498-4	"	25	23-24	490-8	648-1								
5		22-18	510-5	651-8		21-98	504-0	"		17-39	497-8	"		23-27	490-2	"								
10		22-11	511-3	"		21-81	504-6	"		17-31	498-9	650-2		23-51	491-5	"								
15		22-29	511-1	"		22-09	503-6	650-1		17-74	498-3	652-1		23-93	492-2	"								
20		22-52	510-4	650-0		22-09	503-6	"		17-47	499-6	"		24-15	490-8	"								
25		22-65	510-4	"		22-00	502-5	"		17-47	498-2	652-3		24-37	488-3	"								
30		22-45	509-9	"		22-03	501-4	649-3		17-32	498-5	"		24-47	487-2	"								
35		22-45	508-8	"		21-93	502-0	"		17-31	497-9	"		24-60	489-8	"								
40		22-45	508-4	"		22-29	501-5	"		17-14	497-5	"		25-14	490-8	"								
45		22-42	508-0	649-4		22-06	501-5	649-7		17-20	496-7	"		25-25	489-2	"								
50		22-08	507-1	"		22-45	500-4	"		17-34	497-2	"		24-94	487-7	642-7								
55		22-05	507-0	"		21-88	501-4	"		17-81	496-6	"		25-18	489-8	"								
	12 ^h .						16 ^h .						20 ^h .						0 ^h .					
0	25	21-96	507-4	648-8	25	21-91	502-2	651-3	25	17-88	495-7	"	25	25-27	488-8	"								
5		21-86	507-5	"		21-91	502-2	"		17-88	495-9	"		25-54	487-1	"								
10		22-05	507-9	"		21-95	502-2	"		17-88	495-5	"		25-83	489-9	641-3								
15		21-95	508-3	647-6		21-91	502-8	"		18-23	494-9	"		25-90	488-7	641-7								
20		21-91	507-9	"		21-91	502-8	"		18-48	495-0	652-0		25-95	490-5	"								
25		21-68	508-3	"		21-96	503-2	"		18-01	495-2	"		26-30	490-0	"								
30		21-78	508-2	"		21-96	504-6	645-6		18-01	495-5	654-7		26-60	490-2	"								
35		21-84	507-6	"		21-62	506-5	"		17-88	495-1	"		26-73	490-8	641-3								
40		21-61	508-1	"		21-34	507-1	"		17-81	494-3	656-3		27-09	490-2	"								
45		21-73	507-9	"		20-63	506-7	"		18-01	495-0	"		27-00	489-7	"								
50		21-84	507-5	"		19-70	506-9	640-6		18-48	494-4	"		27-09	489-9	"								
55		21-59	507-1	646-3		19-65	508-8	"		18-55	493-2	657-6		27-19	489-8	"								
	13 ^h .						17 ^h .						21 ^h .						1 ^h .					
0	25	21-64	507-1	646-3	25	19-81	504-3	644-1	25	18-59	492-8	659-0	25	27-26	489-1	"								
5		21-75	506-5	"		18-62	504-4	"		18-80	493-5	"		27-29	489-6	"								
10		21-64	506-4	"		18-62	503-4	"		18-99	494-6	"		27-29	491-0	"								
15		21-76	506-3	"		18-38	503-3	646-8		19-22	492-2	"		27-53	490-5	640-3								
20		21-46	506-4	"		18-38	502-3	"		19-22	492-4	655-9		27-74	492-1	"								
25		21-56	506-9	"		18-41	502-8	"		19-80	493-4	"		27-83	492-0	"								
30		21-71	506-5	"		18-48	502-0	647-3		19-93	492-3	654-8		27-61	490-3	"								
35		21-78	506-3	"		18-65	500-9	"		19-70	491-5	653-9		27-46	492-1	640-8								
40		21-86	506-4	"		18-32	501-4	"		19-96	494-2	653-2		27-61	493-6	"								
45		21-84	505-5	"		17-99	499-7	645-9		20-37	491-8	653-5		27-56	494-8	"								
50		21-64	506-0	648-2		17-89	501-7	"		20-50	491-8	"		27-49	495-2	"								
55		21-78	506-5	"		18-06	501-2	"		20-52	493-2	651-3		27-56	495-0	"								

Hour,	10	11	12	13	14	15	16	17	18	19	20	21	22	23	0	1
BIFILAR THERMOMETER, . .	60-4	60-4	60-3	60-3	60-3	60-0	59-7	59-0	58-2	57-6	57-4	57-3	57-4	57-4	57-3	57-3
BALANCE THERMOMETER, . .	60-2	60-5	60-6	60-6	60-6	60-3	60-0	59-5	58-8	58-2	58-0	57-9	57-8	57-6	57-5	57-5
OBSERVER'S INITIAL,	D	D	D	D	H	H	H	H	B	B	B	B	W	W	W	W

BIFILAR. Observed 2^m after the Declination. $k=0-0001205$.
 BALANCE. Observed 3^m after the Declination. $k=0-000015$ approximately.

Göttingen Mean Time of Declination Observation.	JULY 19, 20.						AUGUST 25, 26.										
	DECLINA- TION.		BIFILAR Corrected.	BALANCE Corrected.	DECLINA- TION.		BIFILAR Corrected.	BALANCE Corrected.	DECLINA- TION.		BIFILAR Corrected.	BALANCE Corrected.					
	° ' "	Sec. Div.	Mic. Div.	° ' "	Sec. Div.	Mic. Div.	° ' "	Sec. Div.	Mic. Div.	° ' "	Sec. Div.	Mic. Div.					
	2 ^h .			6 ^h .			10 ^h .			14 ^h .							
0	25 27-46	497-0	640-8	25 21-96	509-7	658-3	25 21-73	506-4	*815-8	25 21-10	503-3	794-1					
5	27-60	496-2	"	21-88	509-4	"	21-12	507-5	812-9	20-65	502-4	794-9					
10	27-61	497-9	"	21-64	509-6	"	20-70	511-4	813-0	20-25	501-8	797-2					
15	27-51	497-2	642-0	21-78	510-3	"	22-05	508-0	813-1	20-61	500-8	798-1					
20	27-54	499-2	"	21-86	510-7	"	22-22	506-8	813-4	20-40	500-6	798-8					
25	27-36	498-1	"	21-78	511-0	655-1	22-58	504-5	816-0	21-14	501-8	798-9					
30	27-29	498-9	"	21-79	512-1	"	22-45	503-5	815-1	21-32	502-5	798-9					
35	27-14	499-0	642-2	21-78	511-8	"	22-03	504-7	"	21-10	503-1	"					
40	26-73	499-4	"	21-53	512-2	"	22-02	506-0	"	22-82	501-2	799-2					
45	26-75	499-5	"	21-48	511-8	"	22-65	508-9	811-8	23-88	499-4	799-1					
50	26-59	498-9	"	21-44	511-7	"	23-04	510-7	"	25-93	498-7	797-0					
55	26-26	498-9	"	21-44	511-2	"	23-74	507-4	"	26-89	500-0	792-7					
	3 ^h .			7 ^h .			11 ^h .			15 ^h .							
0	25 26-15	499-2	646-9	25 21-58	510-3	"	25 23-27	507-7	810-6	25 28-12	500-1	788-8					
5	25-95	498-9	"	21-78	510-0	"	23-43	510-4	808-1	28-68	499-7	785-0					
10	25-68	499-7	"	21-82	509-8	"	23-50	509-6	"	27-96	501-6	779-1					
15	25-31	500-2	645-6	21-91	510-1	"	23-29	507-9	807-3	27-24	500-6	776-5					
20	25-14	500-8	"	21-91	510-2	"	23-39	506-4	"	26-45	501-6	774-4					
25	24-89	502-1	"	21-93	510-7	"	23-24	506-4	809-2	25-78	505-5	771-1					
30	24-60	502-6	645-5	22-13	510-9	"	23-24	506-9	808-2	26-01	505-5	771-0					
35	24-37	503-2	"	22-11	511-8	"	23-14	507-7	"	25-95	503-5	769-1					
40	24-15	503-5	"	22-15	512-4	"	23-26	506-4	"	25-27	503-9	767-9					
45	24-10	504-4	648-3	22-08	511-5	"	23-57	507-0	810-1	24-85	503-7	"					
50	23-86	504-2	"	22-38	511-4	655-4	23-91	506-6	807-9	25-07	499-7	768-1					
55	23-66	506-0	"	22-42	511-1	"	24-20	505-0	"	25-07	499-5	766-8					
	4 ^h .			8 ^h .			12 ^h .			16 ^h .							
0	25 23-76	507-5	649-5	25 22-43	510-3	"	25 24-10	507-4	806-0	25 24-15	498-2	765-2					
5	23-59	507-1	"	22-47	510-0	"	24-13	506-7	803-9	23-32	498-1	763-7					
10	23-39	507-9	"	22-47	509-9	655-3	23-79	502-8	"	22-60	497-7	763-2					
15	23-26	507-7	"	22-45	509-5	"	23-44	504-6	796-7	21-27	498-5	"					
20	23-12	508-2	"	22-52	509-8	"	24-00	505-0	"	20-94	500-1	761-9					
25	23-12	507-4	"	22-58	508-9	"	24-45	507-5	"	20-01	501-1	762-9					
30	22-99	507-1	650-1	22-58	509-5	"	24-08	509-3	799-4	19-63	501-7	764-2					
35	22-79	507-3	"	22-58	508-9	"	24-28	509-9	796-4	19-26	501-7	765-2					
40	22-65	507-2	652-1	22-52	509-1	"	23-64	508-7	"	19-40	499-9	768-3					
45	22-58	507-2	"	22-43	509-5	"	22-97	507-7	792-7	19-63	496-9	771-3					
50	22-58	507-4	"	22-45	509-8	"	22-15	507-5	"	18-55	500-1	"					
55	22-45	507-8	654-5	22-45	509-8	"	21-93	509-7	"	20-05	497-2	774-3					
	5 ^h .			9 ^h .			13 ^h .			17 ^h .							
0	25 22-38	507-7	"	25 22-52	510-5	"	25 22-74	512-1	791-1	25 19-26	498-6	775-5					
5	22-45	508-1	"	22-45	510-1	"	23-19	511-1	790-9	19-22	497-8	779-3					
10	22-45	507-5	"	22-45	509-8	"	23-21	511-6	"	18-21	499-9	779-1					
15	22-38	508-5	"	22-45	508-9	"	23-04	513-5	786-3	17-45	499-4	779-6					
20	22-38	508-7	"	22-35	509-9	"	22-63	514-0	"	17-20	499-7	780-1					
25	22-38	507-9	656-3	22-02	509-4	"	22-83	513-2	"	16-67	499-0	781-6					
30	22-18	508-6	"	21-98	509-4	"	22-97	512-1	785-4	16-58	499-6	783-0					
35	22-05	509-0	658-5	21-91	508-9	"	22-85	510-0	"	16-20	499-6	784-9					
40	21-98	509-8	"	22-05	509-7	"	22-50	507-0	788-5	16-13	500-0	788-0					
45	22-05	509-1	"	22-32	510-3	"	22-18	505-5	790-6	15-94	499-0	791-0					
50	21-98	508-8	"	22-32	509-6	"	21-73	504-5	"	16-20	499-6	792-5					
55	21-90	508-6	658-2	22-35	509-0	651-8	21-56	504-5	792-5	16-17	499-1	792-6					
Hour,	2	3	4	5	6	7	8	9	10	10	11	12	13	14	15	16	17
BIFILAR THERMOMETER, .	57-3	57-6	57-7	57-9	58-0	58-2	58-2	58-0	57-9	64-1	64-2	64-2	64-0	63-7	63-0	62-3	61-8
BALANCE THERMOMETER, .	57-5	57-5	57-8	57-9	58-0	58-2	58-2	58-0	58-0	64-0	64-2	64-3	64-0	63-8	63-4	62-9	62-3
OBSERVER'S INITIAL, . .	II	II	B	B	D	D	W	W		II	II	II	II	B	B	B	B

BIFILAR. Observed 2^m after the Declination. $k=0-0001205$.
 BALANCE. Observed 3^m after the Declination. $k=0-000015$; k (August) = $0-000014$ approximately.

* The readings of the Balance Magnetometer during the August term are not comparable with those on the previous or succeeding terms, owing to re-adjustments of the instrument.

Göttingen Mean Time of Declination Observation.	AUGUST 25, 26.																				
	DECLINATION.			BIFILAR Corrected.			BALANCE Corrected.			DECLINATION.			BIFILAR Corrected.			BALANCE Corrected.					
	°	'	Sec. Div.	Mic. Div.	°	'	Sec. Div.	Mic. Div.	°	'	Sec. Div.	Mic. Div.	°	'	Sec. Div.	Mic. Div.	°	'	Sec. Div.	Mic. Div.	
0	25	16-37	494.9	792.0	25	22-20	485.3	809.3	25	28-01	505.0	818.0	25	21-07	507.6	828.3					
5		16-08	498.9	793.2		22-76	482.8	811.0		27-76	504.9	„		20-85	508.7	826.9					
10		16-77	496.9	796.1		22-92	484.8	„		27-70	506.4	817.6		20-79	507.8	826.1					
15		16-21	498.9	„		22-77	481.4	814.8		27-76	504.0	„		20-95	508.0	826.0					
20		17-20	498.6	„		22-49	483.3	815.2		27-43	506.5	„		20-81	506.8	„					
25		17-17	496.5	796.7		23-64	483.2	„		27-36	504.5	„		20-75	507.3	„					
30		16-50	495.7	„		23-44	483.2	„		26-91	507.3	819.5		20-70	507.7	822.6					
35		15-90	495.3	796.1		23-81	484.6	815.2		27-11	506.9	„		20-70	506.5	„					
40		15-90	497.7	„		23-95	483.2	815.2		26-96	503.2	823.7		20-70	507.4	„					
45		16-58	495.7	„		23-91	482.4	813.8		26-66	503.0	822.7		20-70	507.5	819.9					
50		17-20	493.1	797.1		24-27	485.2	811.4		28-23	504.3	„		20-61	507.1	„					
55		17-07	491.6	„		24-40	485.2	„		26-77	507.7	„		20-57	506.6	„					
			19 ^h .				23 ^h .				3 ^h .				7 ^h .						
0	25	16-91	492.5	„	25	25-25	484.4	810.5	25	26-43	508.5	823.8	25	20-57	506.5	816.1					
5		16-95	491.1	798.2		26-43	481.1	813.5		26-55	508.4	„		20-57	507.1	814.8					
10		16-94	490.6	798.8		26-28	480.1	812.0		26-40	507.9	„		20-70	507.6	„					
15		17-91	489.3	802.0		26-39	480.5	813.3		26-45	509.1	823.5		20-70	507.6	„					
20		18-62	488.3	„		26-05	484.3	811.0		26-37	511.2	„		20-88	506.7	813.8					
25		18-99	486.3	804.0		27-29	479.8	813.8		25-95	507.8	„		20-88	506.7	„					
30		19-33	483.5	805.2		26-75	480.5	813.3		25-63	507.1	828.1		21-04	506.5	810.1					
35		19-53	484.0	805.3		26-86	482.4	813.2		25-39	507.1	830.3		20-97	507.6	„					
40		19-36	485.1	805.6		28-03	484.7	814.7		25-41	509.2	829.0		21-04	508.0	„					
45		19-56	485.7	„		27-76	483.4	814.4		25-21	504.2	831.3		21-10	508.2	„					
50		18-45	486.8	804.8		28-57	482.0	814.4		25-05	504.6	831.8		20-97	509.3	806.4					
55		18-86	485.4	„		28-37	487.1	813.2		24-62	504.0	832.1		21-14	509.0	„					
			20 ^h .				0 ^h .				4 ^h .				8 ^h .						
0	25	16-53	488.3	„	25	28-20	487.9	811.4	25	24-47	505.3	831.6	25	21-31	508.7	„					
5		20-05	488.4	„		28-59	490.9	811.2		24-47	504.0	832.0		21-31	507.1	„					
10		19-83	490.2	„		28-91	490.9	„		24-47	504.6	831.6		21-05	508.8	„					
15		18-18	492.0	„		28-97	495.6	809.6		24-04	502.8	„		20-95	511.6	„					
20		21-66	493.0	„		29-51	493.2	809.4		23-93	503.3	„		20-60	512.7	„					
25		21-51	490.4	801.2		29-26	493.0	810.5		23-64	502.8	830.8		20-41	512.6	„					
30		21-21	491.6	802.3		29-65	493.6	809.9		23-53	502.2	831.3		20-27	513.5	808.1					
35		20-14	492.3	800.6		29-73	497.1	809.2		23-53	502.8	832.4		20-57	514.5	„					
40		20-23	487.2	798.2		29-48	497.2	810.0		23-37	503.7	832.5		20-82	512.0	809.7					
45		19-12	490.4	796.8		30-12	498.0	808.6		23-26	502.6	832.1		20-70	508.0	„					
50		18-68	490.8	„		30-29	496.3	„		22-96	505.3	832.0		20-67	504.8	„					
55		19-83	„		29-58	492.9	810.3		23-12	506.9	„		17-20	506.6	808.1					
			21 ^h .				1 ^h .				5 ^h .				9 ^h .						
0	25	21-17	488.6	802.1	25	29-51	497.3	808.9	25	22-76	505.9	832.0	25	15-59	512.0	80.63					
5		21-10	490.6	802.8		28-37	500.5	805.9		22-65	506.1	830.4		15-12	517.7	„					
10		20-30	489.1	803.4		29-44	498.5	„		22-58	504.6	„		15-96	519.1	„					
15		21-14	487.1	802.5		29-17	503.3	„		22-45	505.4	„		17-20	518.3	„					
20		19-98	488.5	801.7		29-08	501.9	„		22-29	505.1	830.3		18-01	514.5	807.2					
25		21-55	482.9	805.5		28-95	501.0	809.7		22-09	507.3	„		18-12	512.6	„					
30		21-78	485.9	„		28-94	503.5	811.9		21-98	510.0	828.8		18-52	511.1	„					
35		21-76	487.4	803.2		28-77	501.3	813.0		22-03	511.1	827.2		18-55	509.4	„					
40		21-66	483.0	804.1		29-29	500.9	„		21-73	510.2	828.0		18-55	509.5	„					
45		19-89	486.1	803.7		28-30	502.0	„		21-48	508.8	828.8		19-10	509.1	„					
50		21-37	486.7	805.9		28-23	503.2	815.9		21-26	508.6	„		18-82	508.7	806.5					
55		22-58	485.1	807.2		28-08	502.7	„		21-15	509.0	„		18-99	508.9	„					

Hour,	18	19	20	21	22	23	0	1	2	3	4	5	6	7	8	9	10
BIFILAR THERMOMETER, .	61.0	60.2	59.8	59.7	60.0	61.0	62.2	63.4	64.5	65.2	65.0	64.7	64.1	63.9	63.1	62.6	62.0
BALANCE THERMOMETER, .	61.5	60.8	60.4	60.1	60.5	61.2	62.3	63.2	64.1	64.7	64.5	64.3	64.0	63.9	63.4	63.0	62.5
OBSERVER'S INITIAL, . .	D	D	D	W	W	W	W	H	H	H	B	B	D	D	W	W	

BIFILAR. Observed 2^m after the Declination. $k=0.0001205$.
 BALANCE. Observed 3^m after the Declination. $k=0.000014$ approximately.

Göttingen Mean Time of Declination Observation.	SEPTEMBER 20, 21.																			
	DECLINATION.			BIFILAR Corrected.			BALANCE Corrected.			DECLINATION.			BIFILAR Corrected.			BALANCE Corrected.				
	Min.	°	'	Sec. Div.	Mic. Div.	°	'	Sec. Div.	Mic. Div.	°	'	Sec. Div.	Mic. Div.	°	'	Sec. Div.	Mic. Div.			
			10 ^h .					14 ^h .					18 ^h .					22 ^h .		
0	25	15-49	510-0	806-4	25	16-85	508-0	790-9	25	20-41	503-0	777-1	25	18-62	492-8	801-8				
5		16-41	508-0	807-6		16-60	507-3	788-8		19-87	504-5	"		18-57	492-0	"				
10		16-84	508-6	806-6		19-09	498-4	"		20-37	504-1	"		17-99	491-5	"				
15		16-01	511-2	803-9		22-23	496-6	784-4		20-37	503-3	"		18-45	493-0	"				
20		14-76	513-8	801-0		32-20	507-8	754-9		20-37	503-1	"		19-00	492-3	806-4				
25		14-49	517-6	797-9		34-58	507-4	709-9		21-68	505-3	777-9		18-36	490-5	805-1				
30		15-02	519-3	796-1		32-17	500-7	668-7		23-26	504-4	"		18-66	490-1	808-2				
35		15-72	517-2	795-9		29-06	499-0	652-0		22-99	506-4	"		19-04	487-7	"				
40		15-83	516-5	795-3		26-57	509-7	651-5		22-06	508-0	769-5		19-98	484-4	813-3				
45		15-63	513-8	796-3		24-10	509-1	654-2		21-64	507-9	769-4		20-35	482-1	"				
50		15-39	513-4	796-7		23-93	511-6	666-7		21-22	505-8	"		20-16	485-1	815-6				
55		16-06	511-7	798-2		24-50	512-2	678-4		20-23	506-0	"		20-72	486-9	"				
			11 ^h .					15 ^h .					19 ^h .					23 ^h .		
0	25	16-73	510-6	800-9	25	23-76	511-6	687-3	25	19-53	505-7	770-3	25	21-05	486-4	811-5				
5		16-87	509-9	801-8		22-22	508-7	691-3		19-17	504-7	"		20-30	486-8	"				
10		17-34	509-7	802-7		20-52	509-9	693-8		18-55	506-0	774-9		19-40	493-1	808-5				
15		17-88	509-7	803-5		20-05	508-4	698-4		17-56	508-7	"		20-85	488-2	"				
20		18-01	510-5	801-1		19-31	506-0	703-1		17-51	508-4	777-5		19-96	489-2	809-2				
25		18-62	511-4	801-3		17-71	507-5	708-9		16-53	508-4	"		21-14	492-0	"				
30		19-42	511-5	804-2		17-42	506-0	715-5		15-91	507-5	"		21-91	492-1	"				
35		19-83	510-6	804-3		16-77	508-4	720-5		15-77	506-7	780-8		21-37	495-9	"				
40		19-36	511-0	804-0		16-33	509-1	725-5		15-19	507-6	"		22-35	497-5	804-3				
45		19-22	511-9	803-3		16-51	507-7	731-5		15-72	507-3	784-3		22-50	496-1	"				
50		19-22	513-6	803-6		16-53	506-5	735-6		15-49	506-7	"		22-20	495-5	"				
55		19-63	513-9	803-8		15-72	509-5	741-0		14-82	507-8	"		22-90	495-7	"				
			12 ^h .					16 ^h .					20 ^h .					0 ^h .		
0	25	19-42	513-7	804-1	25	16-67	511-6	"	25	15-17	505-4	787-7	25	23-09	496-7	"				
5		19-56	512-8	804-6		16-53	510-6	744-5		14-28	505-5	789-1		24-71	496-6	803-7				
10		19-36	512-4	805-2		16-13	511-2	746-1		14-49	506-0	791-3		24-18	494-7	"				
15		19-22	511-9	"		16-26	510-4	748-5		15-16	505-4	792-9		23-95	492-1	"				
20		19-22	511-7	"		15-86	511-6	"		15-32	503-0	795-5		22-80	497-8	797-0				
25		19-22	511-5	"		15-59	509-3	"		15-16	502-5	"		23-64	496-1	"				
30		19-09	512-2	"		15-86	507-1	754-6		15-16	503-4	"		23-59	494-9	"				
35		19-09	512-8	"		15-86	507-7	760-5		15-59	503-0	798-5		23-26	497-1	"				
40		19-09	512-3	"		16-43	507-6	765-1		15-83	500-7	"		24-11	499-6	"				
45		18-80	512-0	"		17-44	508-0	"		15-64	501-8	"		24-85	501-6	798-4				
50		18-75	512-7	"		17-59	508-5	"		15-88	499-6	800-2		26-08	505-9	"				
55		18-59	511-4	"		17-24	509-5	"		14-65	500-6	"		27-88	505-4	"				
			13 ^h .					17 ^h .					21 ^h .					1 ^h .		
0	25	19-27	510-0	806-3	25	17-05	509-8	"	25	15-22	500-9	802-0	25	26-96	503-7	799-8				
5		19-07	509-4	"		16-80	508-5	"		15-49	499-7	"		26-86	499-9	"				
10		18-68	511-6	"		16-55	503-5	766-8		15-16	499-7	"		27-46	501-6	794-8				
15		19-10	512-0	"		16-50	508-1	"		15-74	496-9	"		27-70	504-3	"				
20		19-17	512-9	"		16-75	504-8	772-3		15-19	494-4	805-8		27-93	505-9	"				
25		19-09	511-8	804-1		17-88	503-0	"		14-89	498-5	"		27-78	504-6	"				
30		19-15	510-5	803-3		17-89	504-3	"		14-65	497-3	799-7		27-93	503-6	"				
35		18-57	512-4	800-1		18-59	504-7	"		14-51	499-5	796-4		27-58	502-0	798-8				
40		18-48	510-6	"		19-17	501-7	775-9		15-96	498-9	796-9		27-41	500-1	"				
45		18-03	509-4	799-0		19-27	502-5	"		16-53	497-0	"		27-47	493-5	"				
50		17-74	509-7	795-8		19-83	501-5	"		17-83	494-2	800-3		27-73	498-0	"				
55		17-20	509-8	793-5		20-32	502-5	"		17-98	492-3	801-7		27-06	498-0	799-1				

Hour,	10	11	12	13	14	15	16	17	18	19	20	21	22	23	0	1
BIFILAR THERMOMETER, . . .	65-0	65-2	65-3	65-3	65-1	65-0	64-9	64-7	64-7	64-5	64-0	63-9	64-0	64-5	65-4	66-3
BALANCE THERMOMETER, . . .	64-5	64-9	65-2	65-2	65-3	65-3	65-2	65-1	65-0	64-8	64-4	64-2	64-5	65-0	65-4	66-2
OBSERVER'S INITIAL,	B	B	B	B	D	D	D	D	W	W	W	W	W	W	W	W

BIFILAR. Observed 2^m after the Declination. $k=0.0001205$.
 BALANCE. Observed 3^m after the Declination. $k=0.000013$ approximately.

Sept. 20^d 14^h 35^m. Bright auroral glare from NW by N to N, extending from the horizon to about 12° altitude. No pencils nor pulsations visible. At 15^h the aurora had disappeared.

Göttingen Mean Time of Declination Observation.	SEPTEMBER 20, 21.						OCTOBER 18, 19.									
	DECLINATION.		BIFILAR Corrected.		BALANCE Corrected.		DECLINATION.		BIFILAR Corrected.		BALANCE Corrected.					
	°	'	Sec. Div.	Mic. Div.	°	'	Sec. Div.	Mic. Div.	°	'	Sec. Div.	Mic. Div.				
0	25	26.32	500.0	799.6	25	22.43	506.3	..	25	16.11	518.9	816.5	25	20.01	517.5	787.4
5		26.32	501.9	..		22.16	506.2	827.9		16.03	519.0	..		19.81	517.8	..
10		26.57	505.4	803.2		22.30	505.2	..		16.53	520.8	815.8		19.29	518.3	788.7
15		26.57	507.1	800.5		20.34	510.7	822.4		17.58	521.2	..		19.15	517.3	..
20		27.81	509.8	799.9		20.05	513.8	821.4		17.78	520.0	814.2		19.44	516.4	..
25		28.28	508.5	800.5		21.05	513.5	..		17.38	519.5	..		20.81	514.9	..
30		28.28	506.5	801.1		21.17	509.4	..		16.80	516.1	811.6		21.79	513.2	..
35		27.38	502.6	801.2		20.75	510.0	..		15.93	517.5	809.2		21.71	513.6	784.2
40		27.61	502.0	801.1		20.43	514.9	..		16.60	520.2	809.6		20.63	515.8	779.3
45		27.27	502.2	798.8		21.12	519.0	814.8		17.32	520.7	807.8		20.55	516.5	774.2
50		27.24	502.5	799.2		21.78	521.4	..		17.64	519.2	806.4		20.47	515.4	770.2
55		27.61	507.0	797.1		21.76	516.2	813.8		17.17	525.5	..		19.87	515.4	765.9
			3 ^h .			7 ^h .					11 ^h .				15 ^h .	
0	25	27.27	507.2	797.8	25	20.65	508.0	819.7	25	17.34	521.4	804.0	25	19.89	514.8	761.3
5		27.20	507.2	..		21.01	498.9	828.7		17.24	521.9	801.1		20.61	512.9	759.7
10		26.80	505.3	..		19.63	497.0	837.1		15.99	520.7	799.9		21.88	509.6	..
15		27.13	509.7	796.7		16.98	492.0	847.1		15.12	521.4	..		22.87	504.6	754.0
20		27.14	512.8	..		10.01	494.6	845.8		14.67	522.4	798.2		23.76	501.7	751.9
25		27.74	517.4	794.6		4.42	506.1	840.2		15.05	523.6	795.5		25.18	500.4	747.8
30		27.80	515.1	795.1		3.58	510.4	838.9		15.76	522.0	798.8		26.75	500.2	744.0
35		27.06	511.5	..		4.19	511.1	836.4		15.63	520.2	797.3		28.14	500.7	737.5
40		26.86	510.9	..		6.77	515.5	..		15.19	519.0	798.3		29.02	501.6	730.4
45		27.04	511.5	797.8		9.25	511.8	836.2		14.83	519.6	796.4		29.78	502.0	724.2
50		27.11	511.2	..		10.59	507.3	833.0		16.31	518.7	..		29.83	505.9	715.5
55		26.72	512.4	..		9.60	504.7	829.4		16.68	515.9	..		29.58	509.9	711.0
			4 ^h .			8 ^h .					12 ^h .				16 ^h .	
0	25	26.48	512.1	799.2	25	8.46	505.1	827.6	25	16.52	514.4	797.3	25	29.33	514.3	706.4
5		26.39	512.4	..		8.85	509.7	824.0		16.35	514.6	..		28.72	510.5	700.4
10		25.76	512.0	..		10.88	511.3	823.0		16.17	515.5	794.9		27.70	522.1	693.9
15		25.99	511.1	..		12.74	512.0	817.7		15.96	514.5	..		25.79	527.4	689.7
20		25.72	509.7	..		13.75	512.2	815.8		15.86	514.8	..		24.62	529.0	686.1
25		25.48	509.6	..		14.85	511.6	..		16.23	513.4	796.2		22.90	528.1	682.3
30		25.25	509.3	..		16.06	507.5	813.7		16.82	513.1	794.5		20.34	528.2	684.6
35		24.78	510.5	..		17.02	507.8	810.6		16.51	513.1	..		18.45	527.6	688.7
40		24.25	509.3	..		17.69	506.1	..		16.53	514.0	..		17.76	524.8	694.7
45		24.11	517.1	..		18.82	505.3	..		16.78	513.4	..		16.71	523.4	697.7
50		23.98	513.9	807.5		19.02	505.7	809.2		17.17	513.6	..		16.28	521.9	703.5
55		22.72	513.5	809.4		19.12	505.2	..		17.41	514.2	..		15.43	519.3	706.9
			5 ^h .			9 ^h .					13 ^h .				17 ^h .	
0	25	21.96	514.1	812.8	25	19.46	504.9	..	25	17.64	515.3	796.1	25	15.00	517.4	710.8
5		21.88	515.2	815.0		19.36	505.6	..		17.64	515.8	..		15.25	517.1	719.6
10		20.67	516.8	817.6		19.36	508.1	803.8		17.17	515.2	..		15.56	514.7	724.3
15		20.40	517.8	819.5		19.39	509.6	..		17.76	515.0	796.0		15.14	513.5	728.9
20		20.63	522.3	820.6		19.36	510.3	801.3		18.10	514.8	..		15.56	512.8	734.8
25		20.72	521.4	821.0		19.60	509.2	817.3		19.09	515.0	..		16.13	512.5	739.2
30		20.10	520.7	..		20.14	506.8	818.8		19.06	516.6	793.6		16.71	511.2	743.4
35		20.85	520.0	..		19.80	507.2	817.3		19.49	517.3	..		16.73	512.7	738.8
40		22.00	519.2	826.1		19.49	506.0	..		19.96	516.3	791.3		16.44	516.1	744.3
45		22.87	516.5	..		19.13	506.6	816.6		19.93	516.0	..		16.67	516.7	746.1
50		22.58	509.1	829.1		19.53	507.0	..		19.78	516.1	..		17.12	516.2	750.9
55		22.20	507.2	..		19.07	508.8	812.9		19.65	517.6	787.8		17.12	514.5	752.4

Hour,	2	3	4	5	6	7	8	9	10	10	11	12	13	14	15	16	17
BIFILAR THERMOMETER, .	67.3	68.3	69.7	70.6	70.8	69.9	68.9	67.9	66.8	49.9	50.7	51.9	52.0	53.0	53.1	53.1	53.0
BALANCE THERMOMETER, .	67.0	67.7	68.4	69.3	69.5	68.6	68.0	67.5	66.9	49.8	50.5	52.0	52.4	53.5	53.5	53.8	54.0
OBSERVER'S INITIAL, . . .	H	D	D	W	W	B	H	H		D	D	D	D	W	W	W	W

BIFILAR. Observed 2^m after the Declination. $k=0.0001205$.
 BALANCE. Observed 3^m after the Declination. $k=0.000013$ approximately.

Göttingen Mean Time of Declination Observation.	OCTOBER 18, 19.																	
	DECLINA- TION.			BIFILAR Corrected.			BALANCE Corrected.			DECLINA- TION.			BIFILAR Corrected.			BALANCE Corrected.		
	°	'	Sec. Div.	Mic. Div.	°	'	Sec. Div.	Mic. Div.	°	'	Sec. Div.	Mic. Div.	°	'	Sec. Div.	Mic. Div.		
	18 ^h .			22 ^h .			2 ^h .			6 ^h .								
0	25	16-89	514.2	754.6	25	17-88	500.3	820.2	25	24-53	516.0	786.9	25	18-12	512.8	813.0		
5		17-17	513.6	757.8		18-59	506.2	"		23-81	515.7	785.3		18-21	514.3	811.7		
10		15-54	513.6	759.9		17-29	505.3	818.6		23-95	515.9	783.7		18-46	515.6	810.7		
15		17-74	513.7	"		18-62	504.8	818.5		23-93	517.4	"		18-62	517.0	810.5		
20		17-79	514.1	764.1		18-82	506.5	818.1		24-85	518.7	787.2		18-93	517.8	810.0		
25		17-85	515.2	763.9		18-93	502.9	816.6		24-60	517.3	787.6		19-47	518.6	808.4		
30		17-98	514.8	764.9		18.32	504.1	815.2		24-51	515.0	787.8		19-86	518.5	808.5		
35		18-15	514.8	765.4		18-60	505.7	813.6		24-27	513.4	786.0		20-37	519.1	807.8		
40		18-25	514.2	773.7		18-73	504.5	816.6		24-04	514.8	785.3		20-54	519.9	806.9		
45		17-99	514.9	776.1		19-80	504.4	815.9		23-29	516.9	785.3		20-74	518.8	806.2		
50		18-30	513.9	779.2		19-96	501.4	815.8		23-73	516.8	782.7		20-72	520.0	804.2		
55		17-72	515.1	779.2		18-68	500.9	814.3		23-12	518.7	"		20-35	520.2	803.8		
	19 ^h .			23 ^h .			3 ^h .			7 ^h .								
0	25	17-88	514.9	"	25	18-59	504.9	812.2	25	22-96	517.5	780.3	25	20-45	519.7	"		
5		17-96	815.1	780.3		19-67	504.8	810.7		22-55	514.1	785.4		20-20	519.3	"		
10		17-67	517.5	780.3		20-23	505.9	811.0		22-02	517.9	783.5		20-25	519.9	804.9		
15		17-42	518.7	"		20-47	505.2	811.9		22-96	522.3	787.0		20-00	518.9	"		
20		17-31	517.7	"		21-55	511.1	808.1		23-12	521.7	788.0		20-11	519.0	"		
25		17-20	515.8	781.7		23-59	509.5	808.3		22-92	516.9	788.8		19-98	519.8	"		
30		17-04	513.0	782.2		22-65	502.1	809.6		22-77	516.3	794.7		19-42	520.5	"		
35		16-55	513.1	783.8		21-95	504.8	808.3		22-76	518.0	790.5		19-33	520.4	"		
40		16-84	512.6	788.1		21-29	500.3	808.0		22-69	516.6	791.3		19-71	519.0	805.5		
45		16-92	512.0	"		21-88	502.4	807.3		22-52	517.5	793.0		20-08	519.0	"		
50		16-92	512.6	790.4		21-53	505.1	807.0		22-30	516.2	793.7		19-96	517.3	806.8		
55		16-70	513.8	792.1		21-78	506.0	805.3		22-05	517.2	793.0		19-91	515.0	807.1		
	20 ^h .			0 ^h .			4 ^h .			8 ^h .								
0	25	16-43	514.5	794.0	25	22-65	503.8	"	25	22-08	518.8	792.9	25	19-71	512.3	816.2		
5		16-91	512.2	796.8		22-08	505.1	804.0		21-95	519.7	792.7		19-70	509.0	819.9		
10		16-53	511.6	"		22-38	506.1	803.4		21-88	518.1	793.3		18-35	510.4	"		
15		16-35	511.3	800.0		22-22	506.4	800.9		21-88	518.1	792.7		17-67	510.6	820.1		
20		16-53	510.6	801.4		22-53	509.1	800.9		21-71	519.1	790.8		17-17	510.7	820.4		
25		16-85	510.5	"		22-85	507.7	799.1		21-46	520.5	789.6		16-10	511.0	821.2		
30		16-78	508.9	803.7		22-72	507.8	797.4		21-32	521.2	789.3		15-32	512.5	"		
35		16-89	509.8	"		22-85	508.2	795.9		21-34	524.6	788.8		14-73	513.6	"		
40		17-12	509.4	804.8		22-70	510.4	793.8		21-37	526.6	792.1		14-51	516.8	"		
45		16-46	511.0	"		22-82	510.8	"		21-12	526.3	791.9		15-32	514.6	"		
50		16-71	510.6	805.8		23-12	510.8	792.6		21-05	523.1	795.7		15-29	511.8	820.5		
55		16-57	508.4	"		23-24	511.3	791.2		21-88	520.4	798.9		13-98	510.9	"		
	21 ^h .			1 ^h .			5 ^h .			9 ^h .								
0	25	16-08	508.2	808.5	25	23-32	511.2	789.7	25	21-48	518.5	801.5	25	13-03	513.0	818.1		
5		16-53	507.3	"		23-63	512.7	788.5		21-49	509.1	805.5		13-03	513.6	817.8		
10		16-31	506.6	812.5		23-63	510.6	788.6		20-67	503.1	816.2		13-91	513.2	817.8		
15		16-17	505.7	"		23-76	510.7	788.5		19-17	499.4	817.9		14-58	511.6	819.5		
20		16-41	506.0	817.7		23-63	509.6	787.6		16-44	509.2	818.3		14-38	512.8	819.0		
25		16-57	504.6	"		23-86	510.3	788.2		16-85	512.4	818.1		14-80	513.9	818.0		
30		16-37	505.3	821.0		23-83	513.3	786.4		17-31	511.2	817.9		16-01	509.4	818.6		
35		16-64	505.3	"		24-03	513.5	785.2		17-14	508.4	818.2		15-49	509.8	816.7		
40		16-94	506.5	822.0		24-03	516.4	785.0		17-42	511.1	817.9		15-32	508.7	815.9		
45		17-64	504.6	"		24-77	518.2	784.2		17-31	512.4	816.4		14-60	511.7	815.8		
50		17-71	504.7	"		24-77	518.1	"		17-71	513.1	815.1		14-40	514.4	814.6		
55		17-78	504.4	823.0		24-71	518.0	784.3		17-91	512.7	813.6		14-82	515.7	"		
Hour,		18	19	20	21	22	23	0	1	2	3	4	5	6	7	8	9	10
BIFILAR THERMOMETER, .		53.6	53.8	53.4	52.3	52.0	52.8	53.7	54.8	56.0	57.2	58.3	58.7	58.6	58.5	58.1	57.7	56.8
BALANCE THERMOMETER, .		54.6	54.9	54.9	54.0	54.0	54.6	55.3	56.0	57.0	58.0	58.9	59.1	59.0	59.0	59.0	58.7	58.0
OBSERVER'S INITIAL, . .		H	H	H	H	B	B	B	B	H	C	C	C	C	D	W	B	

BIFILAR. Observed 2^m after the Declination. $k=0.0001205$.
 BALANCE. Observed 3^m after the Declination. $k=0.000013$ approximately.

Göttingen Mean Time of Declination Observation.		NOVEMBER 24, 25.											
		DECLINATION.	BIFILAR Corrected.	BALANCE Corrected.	DECLINATION.	BIFILAR Corrected.	BALANCE Corrected.	DECLINATION.	BIFILAR Corrected.	BALANCE Corrected.	DECLINATION.	BIFILAR Corrected.	BALANCE Corrected.
Min.	° ' "	Sc. Div.	Mic. Div.	° ' "	Sc. Div.	Mic. Div.	° ' "	Sc. Div.	Mic. Div.	° ' "	Sc. Div.	Mic. Div.	
		10 ^h .			14 ^h .			18 ^h .			22 ^h .		
0	25 16-71	523-0	858-6	25 17-59	520-6	847-9	25 17-81	522-2	848-3	25 18-46	516-2	837-8	
5	16-75	523-9	857-3	17-86	521-9	847-2	17-88	522-5	846-9	18-52	516-3	„	
10	17-05	525-1	864-4	18-19	522-3	843-8	17-88	522-2	846-6	18-46	516-0	„	
15	17-14	526-1	863-0	18-52	521-9	„	17-99	521-7	846-0	18-66	514-5	„	
20	17-14	525-0	860-5	18-92	521-6	843-2	17-88	521-5	845-1	18-35	515-6	„	
25	17-11	524-3	860-3	18-38	521-9	841-5	18-23	521-4	845-5	19-07	514-7	„	
30	17-15	523-2	858-5	18-28	522-0	„	18-32	521-3	843-4	18-79	514-4	837-8	
35	17-17	523-1	857-0	19-07	521-3	„	18-18	522-0	842-9	19-26	514-1	„	
40	17-39	523-9	855-0	19-44	520-2	841-8	17-89	522-6	841-8	19-22	513-1	„	
45	17-67	524-2	854-1	19-33	521-0	„	17-94	522-7	840-9	18-97	512-7	„	
50	17-81	524-4	851-4	19-22	521-0	839-4	17-64	523-8	840-4	19-61	512-7	„	
55	17-15	524-5	850-0	19-06	522-4	„	17-88	522-8	„	19-39	512-6	„	
		11 ^h .			15 ^h .			19 ^h .			23 ^h .		
0	25 17-39	524-5	850-3	25 20-23	523-0	835-4	25 17-91	522-9	840-3	25 19-60	512-8	839-1	
5	17-20	523-7	848-3	18-92	523-6	837-3	17-88	522-6	„	19-61	512-2	„	
10	16-67	523-2	846-9	18-62	522-9	„	17-91	522-3	840-3	19-71	511-7	841-7	
15	16-71	522-5	846-7	18-55	522-9	„	18-03	521-6	839-3	19-70	512-6	840-4	
20	16-51	521-9	851-4	18-62	522-6	836-7	18-28	521-4	838-8	20-14	513-1	842-6	
25	16-40	521-4	851-3	18-55	522-8	„	18-43	521-4	839-0	20-45	512-9	843-9	
30	16-41	521-0	853-3	18-30	523-4	833-6	18-39	522-2	837-8	20-57	512-1	845-1	
35	16-46	520-3	855-2	18-23	523-8	„	18-55	521-3	„	20-57	510-1	845-8	
40	16-28	519-2	856-1	17-89	523-7	832-8	18-38	521-7	„	20-50	511-2	„	
45	16-01	519-9	859-6	18-25	522-7	„	18-41	521-4	837-3	20-70	510-7	846-6	
50	16-40	519-7	861-6	18-25	521-8	834-2	18-12	521-7	836-8	20-60	510-3	847-3	
55	16-40	519-8	860-8	17-62	522-7	„	18-01	522-1	„	20-57	511-3	„	
		12 ^h .			16 ^h .			20 ^h .			0 ^h .		
0	25 16-40	518-6	859-5	25 17-34	523-7	833-4	25 17-89	522-8	838-2	25 20-63	510-7	848-9	
5	16-04	519-7	860-5	17-20	523-9	836-4	17-88	522-3	838-1	20-65	511-3	„	
10	16-06	518-8	861-6	16-97	524-0	„	17-91	522-5	„	20-61	511-2	„	
15	15-86	518-2	863-4	16-78	523-9	„	17-92	522-6	838-6	20-81	511-8	851-1	
20	16-01	518-4	„	16-67	522-9	835-2	17-91	522-6	838-7	20-74	511-7	852-5	
25	16-40	518-5	864-9	16-37	524-1	„	18-26	522-1	840-1	20-84	511-7	„	
30	16-68	519-0	865-2	16-46	523-9	835-7	17-94	521-4	840-7	20-84	511-7	„	
35	17-07	518-8	866-4	16-85	523-8	„	17-88	521-5	841-3	20-60	510-7	„	
40	17-09	519-1	865-4	17-09	523-4	836-0	17-81	521-5	842-2	20-84	512-2	854-0	
45	17-83	518-7	866-5	17-24	522-8	„	17-89	522-2	841-6	20-90	513-0	„	
50	19-51	517-6	864-0	17-07	523-3	„	18-10	521-6	842-0	21-02	512-1	„	
55	20-03	518-5	861-1	17-07	523-8	838-2	17-86	522-0	842-4	21-07	512-6	854-8	
		13 ^h .			17 ^h .			21 ^h .			1 ^h .		
0	25 21-89	521-3	855-4	25 17-20	523-2	838-0	25 18-06	521-5	842-4	25 20-97	512-7	854-8	
5	21-89	522-7	850-7	17-27	523-5	„	18-01	520-8	842-3	21-07	513-0	856-5	
10	21-88	522-2	846-7	17-44	522-6	„	17-81	520-4	842-1	21-12	512-7	„	
15	21-08	521-9	840-9	17-20	523-0	844-4	17-85	520-2	842-5	20-87	512-1	857-4	
20	19-65	521-3	837-4	17-22	523-2	„	18-01	519-4	840-5	20-60	512-3	858-2	
25	18-23	522-2	835-5	17-25	523-1	848-2	17-98	518-7	840-8	20-41	513-9	„	
30	17-27	522-3	833-2	17-20	523-3	848-5	18-01	517-9	840-2	20-74	514-2	857-6	
35	16-68	522-2	„	17-07	523-8	845-2	17-78	519-1	838-9	20-63	514-1	856-2	
40	16-84	521-2	834-7	17-09	524-0	„	18-15	518-1	837-8	20-54	514-8	„	
45	17-45	520-8	844-8	17-00	524-0	847-3	18-06	517-4	837-4	20-63	515-0	„	
50	17-74	520-4	„	17-17	523-9	„	17-88	517-3	837-4	20-63	515-6	„	
55	17-54	520-9	845-0	17-44	523-1	847-2	18-21	517-3	837-1	20-54	515-0	855-6	

HOURLY	10	11	12	13	14	15	16	17	18	19	20	21	22	23	0	1
BIFILAR THERMOMETER, . . .	51-4	52-8	53-0	53-2	54-3	55-2	55-7	55-6	55-3	55-8	55-8	55-5	55-6	55-0	54-7	54-4
BALANCE THERMOMETER, . . .	52-2	53-0	53-5	54-0	55-9	56-3	57-0	56-7	57-0	57-5	57-5	57-3	57-0	57-0	56-5	56-5
OBSERVER'S INITIAL,	D	D	D	D	H	H	H	H	B	B	B	B	W	W	W	W

BIFILAR. Observed 2^m after the Declination. $k=0-0001300$.
 BALANCE. Observed 3^m after the Declination. $k=0-000014$ approximately.

Göttingen Mean Time of Declination Observation.	NOVEMBER 24, 25.						DECEMBER, 20, 21.													
	DECLINATION.		BIFILAR Corrected.	BALANCE Corrected.	DECLINATION.		BIFILAR Corrected.	BALANCE Corrected.	DECLINATION.		BIFILAR Corrected.	BALANCE Corrected.								
	°	'	Sc. Div.	Mic. Div.	°	'	Sc. Div.	Mic. Div.	°	'	Sc. Div.	Mic. Div.								
Min.	2h.			6h.			10h.			14h.										
0	25	20-40	514.4	855.6	25	18-38	518.5	866.8	25	17-27	516.0	839.8	25	18-70	516.0	828.4				
5		20-30	515.4	855.0		18-35	518.7	867.8		17-85	516.1	"		18-97	516.5	827.5				
10		20-30	515.0	"		18-33	518.9	868.4		17-69	515.4	840.0		18-99	516.9	826.7				
15		20-16	516.1	855.8		18-36	518.8	868.9		17-72	515.1	"		18-62	516.4	826.9				
20		20-20	516.7	856.3		18-28	519.0	869.0		17-96	515.4	"		18-55	517.0	825.1				
25		20-03	516.9	"		18-19	519.3	868.8		17-88	516.1	839.5		17-98	517.4	826.1				
30		20-05	517.3	854.8		18-32	519.2	868.9		17-76	517.1	833.9		18-41	217.2	827.2				
35		20-20	517.7	856.3		18-39	519.3	867.2		17-69	517.7	"		18-55	516.4	"				
40		19-91	517.9	"		18-25	519.0	866.8		17-64	516.5	837.0		18-55	515.8	828.3				
45		20-20	518.2	"		18-23	518.7	866.8		17-27	514.5	"		18-84	516.5	827.1				
50		19-91	518.6	856.5		18-32	518.7	866.9		17-36	514.5	835.6		19-02	516.9	828.8				
55		19-89	518.2	856.7		18-38	518.6	867.0		17-56	515.1	"		19-09	516.8	828.2				
		3h.				7h.				11h.				15h.						
0	25	19-86	517.6	856.1	25	18-39	518.8	866.2	25	17-47	515.4	837.2	25	19-13	517.2	830.0				
5		19-56	517.4	857.0		18-38	518.8	864.4		17-42	514.9	837.9		19-22	516.9	829.6				
10		19-60	518.8	857.5		18-41	518.8	864.2		17-74	515.5	"		19-22	517.5	828.9				
15		19-70	518.2	858.2		18-48	519.0	863.6		17-89	516.0	836.4		19-19	517.1	828.3				
20		19-49	516.8	858.8		18-50	518.7	863.0		17-86	516.2	"		19-15	517.7	826.6				
25		19-47	516.8	858.3		18-52	518.5	862.5		17-76	515.6	835.1		19-19	518.0	827.7				
30		19-22	516.2	858.9		18-48	519.1	862.7		18-30	515.7	"		19-20	517.9	827.8				
35		19-20	515.8	859.1		18-46	519.0	863.0		18-25	516.7	832.6		19-26	518.0	828.9				
40		19-31	516.8	858.7		18-35	519.0	860.1		18-53	517.8	833.2		19-22	518.2	829.8				
45		19-22	516.7	859.5		18-05	519.2	861.1		18-43	517.9	"		19-26	518.5	828.2				
50		19-24	516.3	859.5		18-32	519.1	860.8		18-41	517.8	829.7		19-22	519.1	828.0				
55		19-44	518.1	859.7		18-32	518.9	860.1		18-21	517.0	"		19-33	518.2	829.3				
		4h.				8h.				12h.				16h.						
0	25	19-39	517.3	860.1	25	18-41	519.3	859.6	25	18-41	516.5	831.1	25	19-33	518.3	829.7				
5		19-46	516.7	859.9		18-35	519.5	"		18-43	515.6	"		19-22	519.0	828.1				
10		19-22	517.4	859.7		18-41	519.5	857.6		18-25	517.3	829.1		19-36	518.9	828.6				
15		18-97	517.6	859.4		18-39	518.7	858.0		17-38	522.9	824.3		19-42	519.3	827.5				
20		18-72	517.7	859.9		18-01	518.8	"		15-93	524.1	"		19-27	519.5	"				
25		18-72	518.2	859.9		18-16	518.7	857.1		15-77	522.3	822.1		19-36	518.7	"				
30		18-68	517.5	860.4		18-15	518.9	856.6		16-53	518.1	825.1		19-36	518.6	828.8				
35		18-89	518.1	861.0		18-16	518.2	856.4		17-25	515.2	"		19-26	518.9	828.6				
40		18-68	518.6	862.1		18-25	518.7	854.8		17-88	514.7	831.3		19-29	519.3	828.3				
45		18-72	518.6	861.9		17-94	518.4	"		18-15	515.0	830.2		19-24	520.0	827.7				
50		18-70	518.4	861.8		17-85	518.7	853.5		18-38	515.5	"		19-22	520.4	826.1				
55		18-75	518.3	861.6		17-69	518.2	853.4		18-23	516.0	831.4		19-24	520.0	826.6				
		5h.				9h.				13h.				17h.						
0	25	18-75	518.3	865.4	25	17-38	520.1	854.0	25	17-96	516.3	"	25	19-80	518.7	828.9				
5		18-72	518.5	867.5		17-34	519.1	854.6		17-79	515.9	827.6		19-89	518.1	826.8				
10		18-72	518.6	868.4		17-47	518.9	855.7		17-89	515.8	829.5		19-70	519.0	828.6				
15		18-65	518.9	868.3		17-62	519.1	855.8		18-21	516.0	"		19-67	519.2	827.0				
20		18-59	518.9	868.1		17-47	519.1	855.6		18-55	516.9	830.0		19-22	519.7	827.4				
25		18-55	518.9	867.9		17-32	519.0	857.1		18-62	517.9	826.4		19-12	520.1	824.2				
30		18-62	518.5	867.8		17-24	518.9	"		18-86	518.6	"		19-00	520.1	"				
35		18-73	518.6	867.8		17-27	518.6	857.8		18-53	517.7	825.9		18-68	520.4	824.8				
40		18-63	519.1	867.1		17-34	518.0	"		18-79	517.0	829.1		18-63	520.6	824.1				
45		18-57	519.0	867.4		17-74	517.5	860.1		18-70	516.8	827.3		18-68	520.2	824.3				
50		18-55	518.8	867.2		17-85	517.1	862.6		18-55	515.4	"		18-62	520.0	823.7				
55		18-43	518.6	867.0		17-89	517.0	862.2		18-55	515.1	827.4		18-55	520.1	823.2				
Hour,			2	3	4	5	6	7	8	9	10		10	11	12	13	14	15	16	17
BIPILAR THERMOMETER, .			54.6	54.9	54.8	54.1	53.9	54.0	54.2	54.5	54.0		52.7	53.7	54.7	55.6	56.0	56.3	56.7	57.1
BALANCE THERMOMETER,			56.8	57.0	56.7	56.2	55.9	56.0	56.5	56.5	56.3		54.7	55.9	56.9	57.8	58.2	58.4	58.8	59.4
OBSERVER'S INITIAL, . .			H	C	C	C	C	B	D	W			H	H	H	H	B	B	B	B

BIFILAR. Observed 2^m after the Declination. $k=9.0001300$.
 BALANCE. Observed 3^m after the Declination. $k=0.000014$ approximately.

Göttingen Mean Time of Declination Observation.	DECEMBER 20, 21.																
	DECLINA- TION.	BIFILAR Corrected.	BALANCE Corrected.	DECLINA- TION.	BIFILAR Corrected.	BALANCE Corrected.	DECLINA- TION.	BIFILAR Corrected.	BALANCE Corrected.	DECLINA- TION.	BIFILAR Corrected.	BALANCE Corrected.					
	° ' "	Sec. Div.	Mic. Div.	° ' "	Sec. Div.	Mic. Div.	° ' "	Sec. Div.	Mic. Div.	° ' "	Sec. Div.	Mic. Div.					
	18h.			22h.			2h.			6h.							
0	25 18-53	520.4	824.6	25 17-27	516.2	834.5	25 20-88	517.7	840.7	25 20-63	516.5	841.2					
5	18-55	520.6	825.0	17-31	516.0	"	20-99	517.8	841.8	20-79	515.6	840.1					
10	18-46	520.2	824.5	17-27	515.9	"	20-94	517.8	"	20-63	516.2	840.1					
15	18-52	520.3	823.4	17-41	515.8	835.2	20-77	517.8	844.3	20-61	515.7	839.8					
20	18-55	520.1	823.2	17-58	515.7	834.6	20-65	517.9	"	20-61	514.7	840.0					
25	18-63	520.2	823.8	17-64	515.9	834.3	20-77	518.2	842.7	20-55	513.9	"					
30	18-63	520.1	826.2	17-74	516.0	834.8	20-70	518.8	845.5	20-30	514.2	839.7					
35	18-55	520.2	824.6	17-86	515.7	835.1	20-60	518.2	843.8	20-13	513.7	839.8					
40	18-72	520.0	825.7	17-88	515.3	835.4	20-57	518.7	844.5	19-76	513.1	840.0					
45	18-62	520.1	826.1	17-92	515.2	835.2	20-57	518.9	844.6	19-76	514.4	839.9					
50	18-68	520.0	826.3	17-98	515.4	835.6	20-57	518.7	"	19-81	514.3	"					
55	18-68	519.4	826.2	18-21	515.2	835.7	20-54	518.6	843.9	19-94	513.0	840.6					
	19h.			23h.			3h.			7h.							
0	25 18-55	520.0	828.2	25 18-35	515.0	836.7	25 20-48	518.5	843.9	25 19-74	513.7	"					
5	18-57	520.1	830.6	18-41	515.5	838.1	20-43	518.5	"	19-60	513.4	841.7					
10	18-55	520.0	830.8	18-52	514.8	839.9	20-40	518.6	843.0	19-80	513.2	843.2					
15	18-68	519.5	"	18-68	514.7	840.3	20-25	518.7	"	19-83	513.4	842.3					
20	18-62	519.6	830.1	18-63	514.5	841.2	20-27	518.5	843.0	19-27	514.9	"					
25	18-62	519.6	830.7	18-70	514.7	841.4	20-25	518.9	"	19-84	515.8	840.5					
30	18-55	519.7	"	18-79	514.6	842.3	20-30	519.0	843.1	19-89	515.2	840.1					
35	18-55	519.3	830.5	19-07	514.6	843.3	20-38	518.3	"	20-10	515.5	840.8					
40	18-55	519.1	831.6	19-15	515.3	842.4	20-27	518.1	842.1	20-01	515.4	839.2					
45	18-50	519.2	831.1	19-06	515.0	843.2	20-37	518.0	"	19-83	516.3	835.7					
50	18-35	519.2	832.2	19-36	514.1	844.3	20-38	518.3	"	20-32	516.3	"					
55	18-35	519.2	831.1	19-06	514.3	843.5	20-43	518.5	841.3	19-86	516.1	834.6					
	20h.			0h.			4h.			8h.							
0	25 18-41	518.7	831.1	25 19-22	513.7	"	25 20-43	518.9	840.0	25 20-21	515.3	835.4					
5	18-33	518.8	"	19-36	514.1	"	20-18	519.4	"	19-83	514.9	835.3					
10	18-16	518.7	832.5	19-33	514.0	843.0	20-07	518.9	840.1	19-83	514.5	835.4					
15	18-01	518.4	830.8	19-36	513.9	842.1	19-98	518.1	"	19-40	513.5	836.0					
20	18-01	518.3	832.7	19-39	514.0	842.1	19-89	516.7	839.6	19-06	512.5	"					
25	18-01	518.3	831.4	19-65	514.0	840.3	19-86	516.8	839.9	18-50	514.1	833.5					
30	18-01	518.3	832.1	19-42	514.0	"	19-70	518.8	"	18-13	514.5	833.4					
35	18-01	518.0	"	19-78	514.4	"	19-67	519.9	838.7	17-83	513.4	831.1					
40	17-92	518.1	"	19-93	514.8	839.2	19-81	521.3	838.8	17-25	514.1	831.1					
45	17-92	518.2	831.8	19-93	515.4	"	19-89	519.7	840.4	17-22	515.1	830.1					
50	17-88	518.0	831.9	20-38	515.7	"	19-96	517.6	841.1	17-88	514.6	832.8					
55	17-88	517.9	"	20-67	515.5	838.6	19-86	517.3	"	18-01	512.7	834.3					
	21h.			1h.			5h.			9h.							
0	25 17-81	517.3	833.2	25 20-63	515.5	837.8	25 19-83	517.0	840.0	25 17-64	514.0	833.8					
5	17-67	517.5	833.9	20-67	515.7	837.3	19-60	517.4	"	17-67	515.0	831.0					
10	17-67	517.6	832.7	20-70	515.6	838.0	19-29	517.6	841.1	17-54	514.9	830.6					
15	17-56	517.3	834.2	20-70	515.7	"	19-34	517.1	841.8	17-20	515.1	829.4					
20	17-49	517.3	834.6	20-67	515.9	"	19-24	518.2	"	17-27	515.5	829.3					
25	17-45	517.2	834.8	20-68	516.3	838.3	19-60	515.5	844.3	17-47	514.8	829.9					
30	17-38	517.0	834.2	20-82	516.4	838.5	19-89	515.4	"	17-29	514.8	831.2					
35	17-32	516.8	834.4	20-75	516.6	"	19-73	517.3	"	17-34	514.7	830.6					
40	17-27	516.7	833.9	20-97	517.3	839.0	19-83	518.0	842.1	17-34	514.2	829.2					
45	17-27	516.8	834.3	21-08	516.8	840.2	20-03	517.7	"	17-12	513.7	829.2					
50	17-24	516.4	834.0	20-72	516.8	840.6	20-43	517.8	841.5	13-84	515.3	822.9					
55	17-20	516.3	834.0	20-82	516.9	841.7	20-43	518.7	841.3	9-85	518.4	821.6					
Hour,	18	19	20	21	22	23	0	1	2	3	4	5	6	7	8	9	10
BIFILAR THERMOMETER,	57.0	57.0	57.0	57.2	57.0	56.4	56.1	56.1	56.4	56.7	57.0	56.8	56.3	56.0	55.4	55.0	54.6
BALANCE THERMOMETER,	59.3	59.1	59.5	59.6	59.2	58.4	58.5	58.5	58.6	59.0	59.0	58.6	58.2	57.6	57.0	56.3	55.7
OBSERVER'S INITIAL,	D	D	D	W	W	W	W	W	W	W	B	B	D	D	D	W	

BIFILAR. Observed 2^m after the Declination. $k=0.0001300$.
 BALANCE. Observed 3^m after the Declination. $k=0.000014$ approximately.

EXTRA OBSERVATIONS

OF

MAGNETOMETERS.



MAKERSTOUN OBSERVATORY,

1843.

Göttingen Mean Time.	DECLINATION.		BIFILAR.		BALANCE.		Göttingen Mean Time.	DECLINATION.		BIFILAR.		BALANCE.		
	Min. of Obs.	Reading Reduced.	Min. of Obs.	Reading Cor-rected.	Min. of Obs.	Reading Cor-rected.		Min. of Obs.	Reading Reduced.	Min. of Obs.	Reading Cor-rected.	Min. of Obs.	Reading Cor-rected.	
Jan. 2 5	0	25 25-04	2	536.6	3	846.6	Feb. 6 10	10	24 56-48	12	534.5	13	819.1	
	36	5-43	38	536.7	40	865.3		15	25 3-61	17	524.5	18	813.9	
	42	6-37	44	554.6	46	856.2		20	6-77	22	514.5	23	808.7	
	48	12-03	50	555.1	52	853.9		25	4-75	27	528.0	28	797.0	
	54	18-95	56	540.0	58	853.9		30	9-47	32	529.5	33	792.1	
Jan. 2 6	0	20-57	2	535.0	3	874.1		35	12-88	37	527.2	38	786.2	
	6	20-77	8	532.3	10	845.4		40	14-28	42	532.0	43	780.2	
	12	22-38	14	532.2	16	846.4		45	17-24	47	529.9	48	775.2	
	18	25-88	20	531.4				50	19-33	52	525.7	53	774.8	
							Feb. 6 11	55	18-65	57	524.9	58	769.1	
								0	18-43	2	524.9	3	768.6	
								5	18-41					
Jan. 11 8	0	25 23-01	2	527.0	3	834.4	Feb. 6 18	50	23-66	52	534.3	53	740.9	
	20	19-29	22	505.1	23	866.7		19	0	23-79	2	536.8	3	736.6
	25	15-19	27	516.1	28	871.2	Feb. 6 20	0	24-17	2	540.0	3	753.1	
	30	16-94	32	513.2	33	883.5								
	35	13-30	37	512.5	38	895.2								
	40	7-11	42	525.9	43	885.8	Feb. 13 10	0	25 8-17	2	531.1	3	770.0	
	45	9-34	47	535.9	48	875.8		5	7-48	7	534.6	8	768.2	
	50	15-99	52	531.2	53	870.3		10	7-91	12	536.7	13	765.8	
	55	20-43	57	527.4	58	863.5		15	9-87	17	532.0	18	766.9	
Jan. 11 9	0	22-79	2	523.1	3	859.6		20	10-34	22	526.4	23	769.2	
	5	23-26	7	521.9	8	855.7		25	9-54	27	527.5	28	768.2	
	10	22-85	12	526.0	13	849.3		30	9-27	32	532.4	33	766.3	
	15	23-19	17	530.0	18	840.6		35	11-89	37	536.0	38	765.3	
	20	23-79	22	532.3	23	834.7		40	14-38	42	537.9	43	764.7	
	25	24-67	27	532.9	28	828.1		45	17-17	47	538.2	48	763.0	
	30	24-60	32	533.4	33	824.9		50	19-49	52	539.6	53	763.7	
	35	24-53	37	534.2	38	825.8		55	21-91	57	537.0	58	764.9	
Jan. 11 10	0	22-06	2	531.4	3	811.0	Feb. 13 11	0	22-65	2	534.8	3	763.4	
								5	22-32					
Jan. 28 6	0	25 26-66	2	526.5	3	859.4	Feb. 14 8	0	25 21-44	2	526.1	3	773.0	
	10	28-54	12	518.3	13	852.2		9	15-29	11	526.1	12	775.7	
	15	27-80	17	515.1	18	846.7		14	14-06	16	530.2	17	781.2	
	20	25-88	22	521.1	23	843.0		19	16-53	21	530.8	22	782.7	
	25	27-19	27	519.3	28	843.9		24	18-75	26	530.7	27	784.2	
	30	27-13	32	517.5	33	842.9		29	21-17					
					38	842.1		39	21-91	41	521.7	42	774.4	
Jan. 28 8	0	20-87	2	524.2	3	842.0		44	17-31	46	532.2	47	766.0	
								49	11-62	51	543.0	52	757.1	
Feb. 6 8	0	25 21-04	2	532.1	3	806.8		54	5-29	56	557.7	57	747.0	
	25	30-12	27	529.0	28	798.9	Feb. 14 9	59	7-38	1	565.8	2	742.7	
	30	28-35	32	526.4	33	798.6		4	13-17	6	554.1	7	743.2	
	35	25-99	37	528.4	38	797.7		9	13-95	11	550.7	12	739.4	
	40	22-11	42	534.2	43	794.9		14	16-46	16	542.7	17	736.0	
	50	20-60	52	534.1	53	796.6		19	15-69	21	532.4	22	737.3	
	55	19-65	57	530.4	58	800.3		24	13-86	26	527.9	27	741.2	
Feb. 6 9	0	17-04	2	533.4	3	801.7		29	12-36	31	530.0	32	743.1	
	5	16-55						34	13-24	36	534.2	37	744.3	
	10	18-01	12	528.9	13	804.5		39	17-14	41	531.6	42	746.3	
	15	20-10						44	20-37	46	526.9	47	748.2	
	20	25 21-17						49	21-31	51	523.0	52	754.4	
	55	24 45-20	57	520.2	58	834.6		54	22-45	56	524.3	57	755.3	
Feb. 6 10	0	24 44-31	2	538.7	3	830.1		59	22-67					
	5	24 49-42	7	538.7	8	824.8								

BIFILAR. $k=0.0001248$.

BALANCE. $k=0.000015$ approximately.

BIFILAR THERMOMETER. } Feb. 6^d 9^h, { 53°-8
BALANCE THERMOMETER. } 56°-0; 6^d 11^h, { 52°-7; 13^d 11^h, { 51°-3
54°-5; 54°-0.

For the readings of the Bifilar and Balance Thermometers at the hours of the Daily Observations, see the section containing these observations.

Göttingen Mean Time.		DECLINATION.		BIFILAR.		BALANCE.		Göttingen Mean Time.		DECLINATION.		BIFILAR.		BALANCE.			
		Min. of Obs.	Reading Reduced.	Min. of Obs.	Reading Corrected.	Min. of Obs.	Reading Corrected.			Min. of Obs.	Reading Reduced.	Min. of Obs.	Reading Corrected.	Min. of Obs.	Reading Corrected.		
Feb. 14	10	d. h.	m.	° ' "	m.	Sec. Div.	m.	Mic. Div.	Feb. 24	4	d. h.	m.	° ' "	m.	Sec. Div.	m.	Mic. Div.
			4	25 22-08	1	522-9	2	756-9				55	25 41-41	57	547-7	58	796-1
					6	524-2	7	759-3				0	42-10	2	546-0	3	798-3
												5	41-12	7	539-2	8	800-5
Feb. 16	6		0	25 27-34	2	542-0	3	756-1				10	40-73	12	537-9		
Feb. 16	7		40	10-48	42	549-7	43	769-4				15	40-73	17	540-6	18	803-0
			45	12-36	47	548-3	48	771-7				20	41-18	22	533-0		
			50	13-25	52	542-8	53	770-5				25	40-77	27	530-5	28	811-2
			55	12-40	57	544-5	58	768-0				30	38-15	32	527-1	33	819-4
Feb. 16	8		0	14-06	2	543-8	3	767-8				35	36-63	37	528-4	38	827-5
			5	17-44	7	536-7	8	769-8				40	34-73	42	531-2	43	837-0
			10	18-41	12	531-2	13	769-3				45	33-34	47	533-1	48	853-0
			15	17-34	17	529-8	18	769-0				50	31-94	52	530-6	53	867-2
			20	17-27	22	536-8	23	765-2				55	30-68	57	534-0	58	870-7
			25	18-15	27	534-3	28	766-8	Feb. 24	6		0	30-62	2	528-9	3	878-6
			30	17-74	32	535-1	33	766-6				5	28-20	7	526-3	8	879-3
			35	17-51	37	536-0	38	761-4				10	24-37	12	532-6	13	876-7
Feb. 16	10		0	23-19	2	537-8	3	760-6				15	22-67	17	536-6	18	872-0
												20	21-88	22	538-5	23	873-3
												25	21-44	27	534-4	28	876-8
												30	22-49	32	531-3	33	885-0
Feb. 23	18		0	25 21-24	2	544-1	3	725-2				35	22-22	37	527-3	38	889-2
			50	21-17	52	543-9	53	727-5				40	20-14	42	532-4	43	881-1
Feb. 23	20		0	21-51	2	543-9	3	723-0				45	19-20	47	537-9	48	871-7
Feb. 23	22		0	27-38	2	528-7	3	725-8				50	21-59	52	537-9	53	870-6
Feb. 24	0		0	32-27	2	539-1	3	727-8				55	23-29	57	541-7	58	873-6
Feb. 24	1		35	34-21	37	538-6	38	731-8				0	24-78	2	545-3	3	867-7
Feb. 24	2		0	34-68	2	538-6	3	735-9	Feb. 24	7		5	28-08	7	544-5	8	868-2
			10	36-67	12	540-7	13	738-7				10	32-72	12	532-8	13	886-7
			15	36-95								15	30-42	17	533-5	18	896-1
			25	38-62	27	536-4	28	742-8				20	30-02	22	533-5	23	911-2
			30	38-75	32	535-1	33	745-0				25	27-58	27	532-2	28	905-6
			35	38-72	37	531-4	38	746-5				30	26-40	32	530-5	33	899-7
			40	38-01	42	531-7	43	746-9				35	26-66	37	531-2	38	891-8
			45	38-18	47	534-5	48	749-2				40	27-58	42	515-8	43	897-8
Feb. 24	3		0	40-33	2	536-8	3	751-9				45	24-82	47	528-9	48	901-4
			5	40-68	7	540-6	8	753-5				50	28-15	52	527-0	53	894-7
			10	41-61	12	541-3	13	756-6				55	27-38	57	529-3	58	889-6
			15	42-95	17	543-5	18	757-4	Feb. 24	8		0	26-79	2	523-5	3	887-8
			20	43-09	22	539-2	23	764-1				5	22-79	7	527-1	8	878-1
			25	42-43	27	539-9	28	768-9				10	22-05	12	526-1	13	866-0
			30	41-86	32	544-0	33	771-5				15	23-06	17	521-4	18	856-4
			35	42-65	37	544-0	38	775-8				20	22-25	22	519-8	23	855-9
			40	42-53	42	544-1	43	780-8				25	20-10	27	519-1	28	853-5
			45	41-02	47	546-4	48	782-4				30	19-84	32	522-4	33	850-1
			50	41-04	52	550-4	53	785-4				35	19-68	37	521-0	38	850-0
			55	41-39	57	537-9	58	791-1				40	19-07	42	521-0	43	845-5
Feb. 24	4		0	43-60	2	535-2	3	794-1				45	18-08	47	524-9	48	833-9
			5	43-68	7	530-4	8	796-6				50	17-98	52	526-0	53	837-6
			10	42-08	12	525-2	13	798-0				55	18-26	57	528-9	58	830-7
			15	41-00	17	526-8	18	795-5	Feb. 24	9		0	18-18	2	531-8	3	826-2
			20	40-33	22	527-1	23	794-3				5	19-61	7	532-6	8	821-2
			25	38-01	27	534-0	28	792-1				10	21-84	12	529-3	13	816-2
			30	38-18	32	537-9	33	791-5				15	23-16	17	525-9	18	811-1
			35	37-81	37	546-5	38	789-8				20	22-25	22	523-7	23	813-3
			40	38-75	42	554-4	43	789-9				25	21-89	27	525-7	28	807-7
			45	40-65	47	558-7	48	791-6									
			50	40-64	52	551-0	53	794-5									

BIFILAR. $k=0.0001248$.

BALANCE. $k=0.000015$ approximately.

BIFILAR THERMOMETER. } Feb. 24^d 1^h 35^m, { 51°-1; 24^d 3^h, { 51°-3; 24^d 5^h, { 51°-8; 24^d 7^h, { 52°-5; 24^d 9^h, { 53°-1.
 BALANCE THERMOMETER. } { 52°-5; { 52°-6; { 53°-1; { 54°-3; { 54°-8.

Göttingen Mean Time.	DECLINATION.		BIFILAR.		BALANCE.		Göttingen Mean Time.	DECLINATION.		BIFILAR.		BALANCE.	
	Min. of Obs.	Reading Reduced.	Min. of Obs.	Reading Cor- rected.	Min. of Obs.	Reading Cor- rected.		Min. of Obs.	Reading Reduced.	Min. of Obs.	Reading Cor- rected.	Min. of Obs.	Reading Cor- rected.
d. h. Feb. 24 9	m.	° /	m.	Sc. Div.	m.	Mic. Div.	Mar. 6 6	m.	° /	m.	Sc. Div.	m.	Mic. Div.
	30	25 21-53	32	526.5	33	806.9		0	25 28-10	2	535.1	3	740.6
	35	21-51	37	526.5	38	806.2		15	26-28	17	526.3	18	751.5
	40	20-57	42	527.0	43	804.8		20	24-11	22	531.9	23	753.8
	45	19-04	47	527.4	48	798.1		25	22-82	27	538.3	28	754.2
	50	18-41	52	527.4	53	800.0		30	22-92	32	541.8	33	754.4
	55	18-89	57	525.9	58	785.3		35	23-29	37	540.4	38	754.8
Feb. 24 10	0	20-16	2	527.0	3	783.2		40	22 06	42	541.0	43	755.4
								45	21-21	47	540.0	48	755.5
Feb. 25 10	0	25 16-40	2	544.3	3	743.2		50	19-71	52	541.5	53	757.8
	5	9-84	7	559.0	8	736.4	Mar. 6 7	55	19 54				
	10	8-40	12	567.3	13	730.0		0	20-08	2	543.4	3	757.6
	15	10-32	17	563.3	18	730.9		15	23-41	17	540.4	18	759.8
	20	11-82	22	556.5	23	729.4		25	21-32	27	538.4	28	759.0
	25	13-17	27	549.0	28	731.5	Mar. 6 8	30	22 25				
	30	14-78	32	538.4	33	737.7		0	25-75	2	542.3	3	760.4
	35	16-89	37	523.9	38	742.3		15	26-62	17	536.7	18	762.2
	40	15-96	42	516.5	43	744.9		30	25-92	32	533.8	33	765.4
	45	18-92	47	508.3	48	751.2		45	26-53	47	535.7	48	765.0
	50	21-07	52	508.3	53	752.5	Mar. 6 9	0	23-03	2	539.4	3	759.5
	55	21-89	57	511.0	58	752.3		10	19-19	12	544.5	13	758.0
Feb. 25 11	0	22-45	2	515.7	3	750.0		15	14-29	17	544.9	18	758.1
	5	23-23	7	519.4	8	744.5		20	10-73	22	552.2	23	751.0
	10	23-44	12	518.7	13	743.8		25	13-91	27	555.1	28	741.5
	15	21-98	17	522.5	18	742.3	Mar. 6 8	30	17-98	32	545.1	33	737.0
	20	20 13	22	530.5	23	737.7		35	16-64	37	538.7	38	734.6
	25	19-27	27	535.1	28	737.7		40	15-20	42	544.5	43	733.2
	30	18 75	32	536.8	33	732.8		45	14-65	47	549.8	48	728.2
	35	18-46	37	536.0	38	732.8		50	16-10	52	544.4	53	728.7
	40	18-12	42	540.4	43	733.1	Mar. 6 10	55	15-86	57	542.2	58	729.4
	45	19-26	47	541.9	48	732.2		0	15-23	2	536.4	3	726.1
	50	20-40	52	541.0	53	730.2		5	15-52	7	532.0	8	728.1
	55	20-87	57	539.5	58	729.7		10	14-51	12	525.8	13	725.3
Mar. 4 10	0	25 19-81	2	534.8	3	755.4		15	13-32	17	526.9	18	715.5
	5	21-19	7	532.3	8	756.4		20	16-10	22	518.6	23	707.7
	10	22-03	12	531.7	13	756.4		25	18-99	27	507.5	28	704.4
	20	19-70	22	537.2	23	744.9		30	15-32	32	514.0	33	703.4
	25	17-34	27	541.8	28	735.4		35	15-86	37	523.0	38	694.4
	30	14-35	32	542.3	33	729.1		40	18-32	42	528.4	43	696.6
	35	13-81	37	532.1	38	730.3		45	20-00	47	534.2	48	699.6
	40	13-07	42	530.9	43	732.2	Mar. 6 11	50	19-71	52	525.5	53	699.9
	45	14-28	47	535.2	48	728.8		55	15-70	57	529.0	58	700.6
	50	18-12	52	537.4	53	728.2		0	12-51	2	527.1	3	694.0
	55	22-25	57	534.8	58	726.5		5	9-49	7	530.2	8	678.9
Mar. 4 11	0	23-23	2	530.3	3	725.4		10	8-23	12	519.1	13	667.0
	15	21-17	17	532.7	18	724.1		15	6-45	17	513.9	18	664.8
	20	20-43	22	531.7	23	723.5		20	4-45	22	522.7	23	670.6
	30	18-79	32	527.7	33	734.2		25	4-08	27	522.7	28	672.7
	40	19-07	42	525.8	43	740.9		30	5-70	32	520.2	33	676.6
	50	19-09	52	533.3	53	741.1		35	7-08	37	517.0	38	675.4
Mar. 4 12	0	19-96	2	532.4	3	745.0		40	7-26	42	514.1	43	677.4
Mar. 5 18	0	25 22-96	2	528.4	3	729.4		45	7-08	47	512.3	48	681.9
	30	25-54	32	531.8	33	719.2	Mar. 6 12	50	7-55	52	517.7	53	687.8
Mar. 5 20	0	30-37	2	537.3	3	712.2		55	8-98	57	522.2	58	695.9
								0	10-92	2	524.6	3	702.6
								5	12-58	7	524.5	8	703.9

BIFILAR. $k=0.0001248$.

BALANCE. $k=0.000015$ approximately.

BIFILAR THERMOMETER. } Feb. 25^d 10^h—12^h, { 53°-0.
BALANCE THERMOMETER. } 54°-7. March 4^d 11^h, { 50°-7; 52°-0; 6^d 11^h, { 55°-8; 57°-2; 6^d 12^h, { 56°-6; 58°-0.

Feb. 24^d 10^h. For the continuation of these observations, see the *Term Observations*.
Feb. 25^d 10^h. Continued from the *Term Observations*.

Göttingen Mean Time.	DECLINATION.		BIFILAR.		BALANCE.		Göttingen Mean Time.	DECLINATION.		BIFILAR.		BALANCE.	
	Min. of Obs.	Reading Reduced.	Min. of Obs.	Reading Cor-rected.	Min. of Obs.	Reading Cor-rected.		Min. of Obs.	Reading Reduced.	Min. of Obs.	Reading Cor-rected.	Min. of Obs.	Reading Cor-rected.
Mar. 6 12	h. d. m.	° ' "	m.	Sec. Div.	m.	Mic. Div.	Mar. 6 17	d. h. m.	° ' "	m.	Sec. Div.	m.	Mic. Div.
	10	25 13-95	12	521-2	13	702-7		5	25 23-59	7	517-1	8	580-0
	15	14-48	17	521-7	18	702-3		10	21-84	12	521-7	13	587-5
	30	18-13	32	515-3	33	704-5		15	19-89	17	522-9	18	595-9
	45	24-80	42	507-0	43	685-3		20	18-68	22	521-9	23	601-7
	50	27-46	47	505-6	48	663-9		25	17-11	27	521-6	28	608-9
	55	27-16	52	505-1	53	640-4		30	16-91	32	518-4	33	617-6
Mar. 6 13	0	26-01	57	522-9	58	636-1		35	16-85	37	517-2	38	625-6
	5	26-19	2	525-5	3	635-5		40	17-20	42	519-6	43	635-6
	10	25-43	7	518-5	8	632-1		45	17-07	47	521-9	48	647-7
	15	23-70	12	509-6	13	620-3		50	17-45	52	526-1	53	654-7
	20	19-87	17	503-4	18	617-2	Mar. 6 18	55	17-98	57	526-7	58	659-5
	25	16-40	22	506-5	23	623-0		0	17-61	2	525-4	3	661-6
	35	25-22	27	521-6	28	626-8		5	16-67	7	528-8	8	663-8
	40	33-49	33	563-8				10	16-84	12	528-5	13	668-4
	45	32-65	37	550-1	38	645-0		15	17-20	17	528-3	18	671-3
	50	29-75	42	543-4	43	639-1		20	17-71	22	527-7	23	670-5
	55	20-54	47	532-1	48	637-8		25	17-72	27	529-2	28	672-8
Mar. 6 14	0	12-16	52	526-1	53	641-8		30	18-65	32	530-3	33	674-6
	5	8-43	57	534-1	58	651-4		35	19-87	37	527-8	38	677-4
	10	7-58	2	540-9	3	659-8		40	20-58	42	526-5	43	684-4
	15	9-67	7	546-4	8	658-3		45	21-51	47	527-9	48	688-0
	20	11-02	12	548-5	13	652-1		50	22-77	52	521-7	53	690-0
	25	11-98	17	540-5	18	648-2	Mar. 6 19	55	23-12	57	526-5	58	692-2
	30	14-58	22	537-3	23	650-9		0	23-04	2	528-3	3	697-0
	35	15-52	27	536-0	28	645-7		5	23-86	7	527-7	8	700-9
	40	15-25	32	531-9	33	638-6		10	24-74	12	525-1	13	703-7
	45	14-29	37	526-7	38	633-2		15	24-53	17	526-1	18	705-3
	50	12-16	42	523-9	43	630-3		20	24-60	22	527-8	23	705-6
	55	11-15	47	519-8	48	622-7		25	24-40	27	530-9	28	705-7
Mar. 6 15	0	9-82	52	519-8	53	617-8		30	24-30	32	532-6	33	702-8
	5	9-74	57	516-3	58	614-4		35	25-75	37	531-7	38	702-0
	10	9-81	2	516-5	3	613-9		40	26-01	42	530-2	43	703-7
	15	10-52	7	514-4	8	614-7	Mar. 6 20	45	25-90	47	530-5	48	705-4
	20	11-19	12	513-9	13	616-6		25	23-53	27	528-5	28	712-5
	25	11-80	17	513-0	18	619-9		30	23-16	32	529-3	33	714-1
	30	13-10	22	512-2	23	621-5		35	22-03	37	531-5	38	715-2
	35	13-79	27	515-0	28	626-9	Mar. 6 21	40	21-91	42	532-9	43	717-5
	40	14-01	32	512-3	33	629-7		0	22-00	2	531-8	3	718-8
	45	13-15	37	513-7	38	630-1		20	22-08	22	527-6	23	721-1
	50	13-24	42	515-8	43	631-4		25	21-79	27	528-8	28	722-0
Mar. 6 16	0	14-45	47	515-8	48	632-1		30	23-14	32	528-9	33	724-0
	5	15-76	52	514-5	3	634-5	Mar. 6 22	35	23-93	37	528-6	38	721-3
	10	16-53	57	511-6	8	632-8		40	24-22	42	527-7	43	721-1
	15	18-52	2	509-2	13	627-4	Mar. 6 23	45	28-59	47	514-3	48	737-5
	20	20-16	7	508-5	18	622-3		10	28-72	12	513-4	13	737-8
	25	22-38	12	504-2	23	619-3		20	29-31	22	518-2	23	737-8
	30	23-39	17	503-0	28	614-4		30	30-40	32	514-8	33	737-8
	35	24-29	22	503-0	28	614-4		40	29-78	42	517-8	43	737-8
	40	27-90	27	501-9	33	604-8	Mar. 7 0	0	25 30-05	2	521-5	3	739-7
	45	31-14	32	494-5	38	605-7	Mar. 7 1	20	35-35				
	50	30-32	37	495-0	43	607-2	Mar. 7 2	0	31-33	2	536-4	3	759-5
	55	27-94	42	502-6	48	597-6		35	33-92	37	530-6	38	765-9
Mar. 6 17	0	25-56	47	503-8	53	584-1	Mar. 7 3	40	36-70	42	538-4	43	791-2
			57	507-6	58	583-0		45	35-53	47	539-5	48	792-2
			2	511-5	3	579-2							

BIFILAR. $k=0-0001248$.

BALANCE. $k=0-000015$ approximately.

BIFILAR THERMOMETER. } March 6^d 14^h, { 56°-0; 6^d 15^h, { 55°-5; 6^d 16^h, { 55°-1; 6^d 17^h, { 55°-1; 6^d 18^h, { 55°-2; 6^d 19^h, { 55°-6;
 BALANCE THERMOMETER. } { 57°-5; { 57°-5; { 57°-4; { 57°-6; { 58°-0; { 58°-0;
 6^d 20^h, { 56°-0;
 { 58°-5

March 6^d 14^h. Auroral light seen through the clouds to NNW.

Göttingen Mean Time.			DECLINATION.		BIFILAR.		BALANCE.		Göttingen Mean Time.			DECLINATION.		BIFILAR.		BALANCE.	
			Min. of Obs.	Reading Reduced.	Min. of Obs.	Reading Cor- rected.	Min. of Obs.	Reading Cor- rected.				Min. of Obs.	Reading Cor- rected.	Min. of Obs.	Reading Reduced.	Min. of Obs.	Reading Cor- rected.
Mar.	d.	h.	m.	°	m.	Sec. Div.	m.	Mic. Div.	Mar.	d.	h.	m.	'	m.	Sec. Div.	m.	Mic. Div.
Mar.	7	4	0	25	39.46	2	547.4	3	803.5	Mar.	7	8	40	25	24.13	42	527.8
			10		38.18	12	549.6	13	813.6				45		25.14	47	528.0
			15		36.65	17	548.6	18	820.5				50		25.09	52	528.5
			20		36.70	22	548.4	23	830.2				55		25.27	57	529.1
			25		34.65	27	543.9	28	834.3	Mar.	7	9	0		26.03	2	526.8
			30		31.09	32	551.0	33	830.6				5		26.13	7	524.7
			35		31.73	37	560.7	38	831.0				10		25.05	12	528.0
			40		32.75	42	551.2	43	830.5				15		25.31	17	529.3
			45		32.17	47	543.9	48	832.9				20		26.52	22	523.5
			50		33.67	52	547.2	53	838.8				25		26.19	27	522.3
			55		35.32	57	555.9	58	846.5				30		25.52	32	527.7
Mar.	7	5	0		36.13	2	546.7	3	875.3	Mar.	7	10	0		25.83	2	528.6
			5		32.38	7	545.2	8	888.6				0				
			10		29.24	12	543.7	13	901.8				0	25	25.73	2	540.5
			15		24.40	17	536.2	18	908.4				15		25.76	17	542.7
			20		18.72	22	540.4	23	897.3				25		24.20	27	526.8
			25		16.15	27	549.4	28	885.3				30		22.89	32	524.0
			30		20.16	32	548.8	33	880.2				40		22.69	42	529.2
			35		24.03	37	548.0	38	881.9	Mar.	9	7	0		21.91	2	523.1
			40		30.03	42	527.5	43	905.3				15		22.11	17	534.8
			45		17.18	47	547.6	48	895.6	Mar.	9	8	0		25.92	2	533.9
			50		20.40	52	551.1	53	884.9				0				
			55		27.06	57	550.9	58	884.7				0	25	24.74	2	538.9
Mar.	7	6	0		29.80	2	546.8	3	887.8	Mar.	10	8	25		21.10	27	561.8
			5		31.59	7	540.9	8	891.9				30		24.42	32	552.5
			10		26.46	12	553.8	13	888.2				35		24.96	37	541.4
			15		31.64	17	549.7	18	894.1				0		21.61	2	539.9
			20		29.95	22	551.9	23	883.7	Mar.	10	9	0		23.07	2	537.0
			25		35.27	27	545.5	28	896.6				0				
			30		32.38	32	539.5	33	902.0				0	25	21.81	2	546.3
			35		30.07	37	550.3	38	900.0				30		17.94	32	553.9
			40		31.38	42	541.2	43	909.5				35		17.85	37	550.9
			45		28.01	47	548.5	48	908.3				45		17.14	47	545.1
			50		29.75	52	550.4	53	914.0				55		16.75	57	542.0
			55		30.20	57	553.7	58	914.6	Mar.	11	8	10		17.22	12	527.0
Mar.	7	7	0		31.59	2	548.3	3	923.5				20		18.05	22	520.7
			5		29.66	7	541.9	8	924.4				25		17.38	27	517.9
			10		26.55	12	551.4	13	921.0				30		15.90	32	518.5
			15		28.64	17	545.7	18	921.5				35		14.48	37	521.1
			20		27.93	22	548.2	23	917.6				40		13.81	42	523.3
			25		29.65	27	555.3	28	922.6				50		14.98	52	526.7
			30		33.31	32	551.7	33	935.9	Mar.	11	10	0		17.69	2	529.8
			35		32.05	37	550.7	38	953.1				10		19.81	12	532.4
			40		32.13	42	555.9	43	975.1				0				
			45		34.28	47	548.6	48	995.1				30	25	26.00	30	560.0
			50		37.14	52	538.9	53	004.1	Mar.	12	5	3		25.00		
			55		38.82	57	520.6	58	1016.8	Mar.	12	7	16		24.45.00	15	555.0
Mar.	7	8	0		32.40	2	513.5	3	1028.2				25	25	18.00	27	518.0
			5		24.24	7	510.7	8	1012.1								
			10		18.08	12	512.6	13	1976.7								
			15		15.56	17	523.3	18	951.2								
			20		18.66	22	526.4	23	934.1								
			25		22.00	27	524.4	28	925.7				55	25	20.13	57	544.3
			30		23.37	32	522.8	33	917.6	Mar.	12	13	0		23.50	2	550.7
			35		23.23	37	526.5	38	902.0				5		25.61	7	540.9

BIFILAR. $k=0.0001248$.

BALANCE. $k=0.000015$ approximately.

BIFILAR THERMOMETER. } March 12^d 13^h, { 51°.3
BALANCE THERMOMETER. } 52°.7

March 7^d 8^h. Auroral arch spanning 90° of horizon; altitude of apex in the magnetic meridian 10°; breadth of the belt 8°; no pencils visible.
 March 12^d 5^h 30^m. (Sunday.) A slight disturbance was observed, and a few observations, given above, were made; it was noted that the disturbance had increased very much at 7^h; continuous observations were commenced on Monday morning.
 March 12^d 13^h. Faint auroral light; stronger four hours ago.

Göttingen Mean Time.		DECLINATION.		BIFILAR.		BALANCE.		Göttingen Mean Time.		DECLINATION.		BIFILAR.		BALANCE.					
		Min. of Obs.	Reading Reduced.	Min. of Obs.	Reading Cor-rected.	Min. of Obs.	Reading Cor-rected.			Min. of Obs.	Reading Reduced.	Min. of Obs.	Reading Cor-rected.	Min. of Obs.	Reading Cor-rected.				
Mar. 12	13	d.	h.	m.	°	'	m.	Sc. Div.	m.	Mic. Div.	Mar. 18	3	m.	°	'	m.	Sc. Div.	m.	Mic. Div.
		10	25	29.68	12	524.6	13	544.3	45	25			36.27	47	542.2	48	727.4		
Mar. 12	14	15		29.21	17	512.9	18	533.0	50		36.09	52	534.3	53	732.3				
		20		29.14	22	503.8	23	510.3	55		35.56	57	533.4	58	733.4				
		25		30.02	27	489.6	28	495.5	Mar. 18	4	0		35.47	2	535.8	3	733.2		
		30		27.67	32	488.4	33	493.9			10		35.71	12	541.8	13	733.6		
		35		24.77	37	499.7	38	493.3	Mar. 18	5	53		26.60	57	541.0	58	781.0		
		40		24.71	42	497.7	43	501.3			Mar. 18	6	0		13.91	2	559.9	3	780.0
		45		21.58	47	508.7	48	520.7	5				15.25	7	572.6	8	772.0		
		50		19.36	52	519.1	53	535.3	10		22.11	12	564.8	13	769.3				
		55		19.49	57	528.1	58	547.4	15		25.96	17	553.0	18	769.3				
		0		21.91	2	523.8	3	557.5	20		26.06	22	544.2	23	768.3				
		5		23.09	7	526.9	8	571.3	25		26.46	27	547.3	28	766.3				
10		23.12	12	534.1	13	580.6	30		28.05	32	537.7	33	768.8						
15		22.89	17	523.0	18	592.9	35		25.72	37	531.1	38	768.8						
Mar. 12	15	20		22.18	22	524.4	23	603.4	40		22.97	42	537.3						
					27	519.9	28	613.0	45		24.24	47	535.2						
					32	514.5	33	619.6	50		24.53	52	530.4	53	771.2				
				22.42	37	516.4	38	629.3	55		23.06	57	531.2	58	768.7				
		35		22.02	42	515.0	43	634.2	Mar. 18	7	0		22.67	2	535.8	3	766.7		
		40		21.37	47	517.5	48	636.6			5		24.27	7	535.9	8	766.7		
		45		20.87	52	520.1	53	636.7	10		26.25	12	534.3						
		50		20.13	57	525.5	58	635.6	15		26.96	17	531.0	18	761.1				
		55		20.94	2	526.2	3	631.6	20		26.55	22	530.9						
		0		21.78	7	526.7	8	630.6	Mar. 18	8	0		24.82	2	535.5	3	748.3		
		5		22.05	12	526.7	13	626.2											
10		22.65	17	527.6	18	623.1	Mar. 20	10	0	25	19.15	2	531.9	3	712.6				
15		22.99	27	531.0	28	618.9			5		17.61	7	533.5	8	712.3				
20		22.99							15		16.58	17	533.2	18	713.8				
Mar. 12	16	30			12	520.2	13	658.3	20		16.08								
		15		21.07	17	520.2	18	657.5	Mar. 20	11	5		21.71	7	526.2	8	701.8		
		20		20.84	22	522.1	23	660.5			10		21.37	12	527.4	13	702.1		
		30		20.37	32	525.7	33	668.8	Mar. 21	8	0	25	24.58	2	545.6	3	711.4		
		35		20.34	37	525.6	38	673.2			18		557.7						
Mar. 12	18	0		22.25	2	527.7	3				699.5								
Mar. 14	4	0	25	26.73	2	534.6	3	724.4	20		26.01	22	560.9	23	699.3				
Mar. 14	5				17	524.4	18	752.5	25		25.76	27	556.9	28	696.0				
Mar. 14	6	20		17.71					30		24.96	32	547.7	33	696.6				
		30		20.60	32	529.3	33	755.7	35		21.98	37	540.4	38	695.5				
		35		21.17	37	529.8	38	754.6	40		20.54	42	536.6	43	700.0				
		0		23.86	2	534.9	3	745.3	45		18.06	47	535.4	48	702.5				
									50		16.08	52	538.1	53	706.0				
Mar. 18	0	0	25	31.14	2	527.1	3	701.9	55		15.16	57	539.1	58	706.9				
Mar. 18	1	35		34.36	37	539.5	38	700.6	0		14.92	2	541.2	3	706.8				
Mar. 18	2	40		34.85	42	536.9	43	702.9	5		15.83	7	542.0						
		50		34.48	52	535.2	53	704.2	20		20.63								
		0		34.26	2	539.3	3	701.2	Mar. 21	10	0		24.22	2	536.2	3	707.3		
					33	559.0			Mar. 21	13	0		23.79	2	536.3	3	698.6		
		35		25.59	37	549.4	38	703.6	Mar. 21	14	0		23.84	2	540.9	3	691.6		
50		36.21	52	552.3	53	707.4	Mar. 21	15	0		22.35	2	535.7	3	693.8				
55		35.59	57	547.7	58	708.4	Mar. 21	16	0		21.95	2	538.8	3	693.7				
Mar. 18	3	0		35.20	2	549.6	3	711.4	Mar. 21	17	0		21.64	2	538.0	3	691.0		
		20		36.63	22	553.0	23	717.4	Mar. 21	18	0		23.32	2	542.4	3	690.2		
		30		37.28	32	552.2	33	720.0	Mar. 21	19	0		24.60	2	537.9	3	690.7		
		40		36.97	42	544.3	43	724.7	Mar. 21	20	0		22.72	2	536.7	3	694.7		
									Mar. 21	22	0		22.23	2	532.5	3	694.0		

BIFILAR. $k=0.0001248$.

BALANCE. $k=0.000015$ approximately.

BIFILAR THERMOMETER. } March 12^d 14^h, { 51°·4; 12^d 15^h, { 51°·2; 12^d 16^h, { 50°·7; 18^d 3^h, { 51°·9; 18^d 7^h, { 53°·5; 21^d 9^h, { 50°·9;
 BALANCE THERMOMETER. } March 12^d 14^h, { 53°·8; 12^d 15^h, { 51°·0; 12^d 16^h, { 52°·6; 18^d 3^h, { 50°·5; 18^d 7^h, { 52°·5; 21^d 9^h, { 50°·5;
 21^d 13^h, { 48°·8; 21^d 14^h, { 48°·6; 21^d 15^h, { 48°·2; 21^d 16^h, { 48°·0; 21^d 17^h, { 47°·7; 21^d 19^h, { 47°·4;
 21^d 13^h, { 49°·0; 21^d 14^h, { 48°·8; 21^d 15^h, { 48°·5; 21^d 16^h, { 48°·4; 21^d 17^h, { 48°·0; 21^d 19^h, { 47°·9.

March 21^d 13^h—17^h. Hourly observations made during the Meteorological Term.

Göttingen Mean Time.		DECLINATION.		BIFILAR.		BALANCE.		Göttingen Mean Time.		DECLINATION.		BIFILAR.		BALANCE.	
		Min. of Obs.	Reading Reduced.	Min. of Obs.	Reading Cor- rected.	Min. of Obs.	Reading Cor- rected.			Min. of Obs.	Reading Reduced.	Min. of Obs.	Reading Cor- rected.	Min. of Obs.	Reading Cor- rected.
Mar. 21	23	0	25 25.95	2	528.4	3	694.1	Mar. 29	9	55	25 13.34	57	524.3	58	666.9
Mar. 22	0	0	25 30.43	2	527.0	3	688.4	Mar. 29	10	0	6.44	2	550.5	3	678.9
		5	28.97	7	520.5	8	690.8			5	1.59	7	547.7	8	666.5
		25	29.31	27	527.5	28	687.9			10	1.63	12	547.3	13	625.3
		40	29.80	42	536.5	43	682.1			15	3.79	17	555.5	18	600.6
Mar. 22	1	45	30.18	47	536.9	48	682.9			20	10.11	22	554.6	23	587.6
		40	34.09	42	544.9	43	682.9			25	14.78	27	540.1	28	579.5
		45	35.08	47	545.6	48	683.9			30	17.00	32	526.1		
Mar. 22	2	0	35.67	2	548.3	3	685.8			40	17.00	42	505.9	43	589.7
		20	34.48	22	544.6	23	692.5			45	11.93	47	507.9	48	614.4
		30	36.51	32	558.0	33	691.9			50	5.56	52	517.2	53	627.7
		35	36.95	37	554.0	38	691.2	Mar. 29	11	55	2.17	57	524.0	58	635.1
		40	35.15	42	544.9	43	699.0			0	1.09	2	532.0	3	640.6
		45	34.85	47	540.9	48	700.1			5	1.98				
		50	34.73	52	535.4	53	703.8			10	5.70	12	529.8	13	644.5
Mar. 22	3	55	35.77	57	530.9	58	706.2			15	8.37	17	524.7	18	650.0
		0	36.16	2	525.9	3	711.5			20	8.55	22	528.2	23	654.9
		5	35.46	7	522.6	8	711.2			25	8.80	27	532.4	28	654.2
		10	35.05	12	526.0	13	710.1			30	9.98				
		30	34.79	32	538.6	33	710.5			45	13.03	47	533.3	48	650.2
Mar. 22	4	40	33.92	42	538.5	43	711.9			50	13.30	52	532.7	53	652.2
		0	32.28	2	542.9	3	714.5	Mar. 29	12	55	13.62	57	533.7	58	658.8
										0	13.84	2	533.9	3	653.1
										5	14.65	7	536.8	8	653.1
Mar. 29	6	0	25 27.38	2	544.4	3	725.3			10	15.19	12	537.1	13	653.1
Mar. 29	7	15	19.24	17	551.0	18	809.1			15	15.52			18	653.0
		20	17.58	22	555.5	23	835.3			20	15.99	22	538.2	23	652.1
		25	14.62	27	551.4	28	856.6								
		30	12.40	32	544.2	33	844.3	Apr. 5	2	0½	25 36.06	21½	549.5	31½	657.7
		35	11.15	37	545.0	38	788.8			25½	31.32	27½	524.0	28½	682.7
		40	17.24	42	540.9	43	785.8			30½	31.64	32½	526.2	33½	684.8
		45	18.95	47	543.6	48	803.1	Apr. 5	3	25½	32.22	27½	550.8	28½	712.7
		50	17.79	52	543.6	53	788.1			30½	31.97	32½	550.1	33½	714.7
		55	22.35	57	537.4	58	777.5			45½	37.10	47½	542.8	48½	729.3
Mar. 29	8	0	19.42	2	538.4	3	747.5			50½	35.53	52½	549.1	53½	731.3
		5	23.79	7	522.3	8	720.7			55½	33.99	57½	555.3	58½	734.2
		10	23.68	12	518.1	13	755.9	Apr. 5	4	0½	34.55	21½	555.9	31½	737.7
		15	15.49	17	532.9	18	746.9			5½	36.13	7½	557.1	8½	742.8
		20	15.30	22	537.2	23	747.0			10½	36.31	12½	564.4	13½	743.5
		25	15.46	27	535.9	28	733.5			15½	37.51	17½	562.5	18½	743.6
		30	16.30	32	534.9	33	716.2			20½	37.41	22½	577.7	23½	749.8
		35	19.04	37	536.8	38	702.6			25½	41.54	27½	572.0	28½	760.7
		40	20.05	42	538.1	43	691.4			30½	42.26	32½	563.0	33½	770.1
		45	21.82	47	529.0	48	696.8			35½	38.60	37½	583.3	38½	772.1
		50	18.95	52	531.6	53	704.7			40½	42.60	42½	580.1	43½	793.3
Mar. 29	9	0	17.14	2	534.1	3	719.3			45½	43.17	47½	585.8	48½	804.5
		5	16.53	7	531.4	8	722.7			50½	44.50	52½	580.9	53½	830.3
		10	13.21	12	533.9	13	724.1			55½	45.75	57½	579.4	58½	882.5
		15	13.03	17	537.3	18	721.0	Apr. 5	5	0½	38.89	21½	604.4	31½	975.0
		20	12.36	22	537.3	23	710.7			5½	36.80	6½	628.6		
		25	14.03	27	530.9	28	702.5					7½	647.	8½	1049.9
		30	14.83	32	527.0	33	691.9			10½	27.29	11½	662.		
		35	14.06	37	529.2	38	687.9					12½	671.	13½	1124.4
		45	13.34	47	522.8	48	670.3							14½	1137.3
		50	12.94	52	522.4	53	667.2			15½	20.23	17½	697. ?	18½	1202.0

BIFILAR. $k=0.0001248$.

BALANCE. $k=0.000015$ approximately.

BIFILAR THERMOMETER. } March 21^d 23^h, { 47°-7'; 22^d 3^h, { 53°-3'; 29^d 7^h 15^m, { 48°-0'; 29^d 9^h, { 47°-4'; 29^d 11^h, { 45°-9';
 BALANCE THERMOMETER. } { 47°-9'; { 52°-4'; { 47°-1'; { 47°-0'; { 46°-0';
 29^d 12^h, { 45°-1'; { 45°-3'

March 29^d and April 5^d. See notes on Aurora, p. 61.

April 5^d 5^h. The readings of the Bifilar from 5^h 5^m till 45^m were estimated, as the scale, though in view, was beyond the vertical wire of the telescope; at 17½^m the scale was completely out of the field, and the reading given is a rough approximation.

The half minutes in the times of observations before 6^h 5^m are due to clock error.

Göttingen Mean Time.			DECLINATION.		BIFILAR.		BALANCE.		Göttingen Mean Time.			DECLINATION.		BIFILAR.		BALANCE.			
d.	h.	m.	Min. of Obs.	Reading Reduced.	Min. of Obs.	Reading Cor-rected.	Min. of Obs.	Reading Cor-rected.	d.	h.	m.	Min. of Obs.	Reading Reduced.	Min. of Obs.	Reading Cor-rected.	Min. of Obs.	Reading Cor-rected.		
Apr.	5	5	20½	25 26-82	m.	Sc. Div.	m.	Mic. Div.	Apr.	5	7	34	25 32-20	m.	Sc. Div.	m.	Mic. Div.		
			21½		21½	676.	23½	1161-9				32½	457-9	31	457-9	31	987-0		
			22½		22½	673.	24½	1185-3				34	447-2	32½	452-0	32½	1001-0		
			25½	57-07	26½	665.	28½	1162-9				35	28-57	34	447-2	35	447-7	37½	981-6
			27½		27½	661.	29½	1101-6				40	25-54	37½	456-1	40	459-4	41	950-5
			29½	42-25	30½	648.	31½	1103-3				42½	18-65	42½	471-8	42½	471-8	42½	947-2
			30½	43-36	32½	644.	33½	1177-2				45	15-39	45	475-9	46	475-9	46	930-7
			33½	31-86	34½	645.	35½	1147-4				50	16-01	47½	488-1	47½	488-1	47½	922-2
			35½	24-20	38	646.	38	1102-2				50	15-39	50	498-2	50	498-2	52½	904-2
			40½	44-23	40½	635-2	43	1158-3				55	16-01	52½	503-7	52½	503-7	52½	904-2
			43		43	632-0	48	1239-4				55	16-01	55	513-5	55	513-5	57½	901-8
			45½	39-99	45½	631-5	48	1239-4				0	16-57	57½	510-6	57½	510-6	3	897-1
48		48	624-0	53	1188-5	5	17-88	2	509-4	2	509-4	8	886-7						
50½	25-75	50½	606-2	53	1188-5	10	20-52	7	493-6	7	493-6	13	881-7						
53		53	606-0	58½	1148-7	15	20-77	12	495-1	12	495-1	18	860-7						
55½	22-72	57½	605-0	59½	1125-6	20	18-95	17	490-1	17	490-1	23	851-3						
Apr.	5	6	0½	23-56	3½	592-1	4½	1065-6	25	19-17	22	474-9	28	840-4					
			5½	30-99	7½	594-6	8½	1058-0	30	19-61	32	441-0	33	808-4					
			10	43-68	12	572-4	13	1111-8	35	19-46	37	463-6	38	803-5					
			15	33-57	15	553-5	17½	1067-4	40	17-11	42	510-5	43	801-6					
			20	32-80	17½	559-5	19	1055-7	45	14-82	47	494-4	48	826-7					
			22	35-15	20	563-3	19	1055-7	50	15-02	52	466-7	53	802-1					
			25	35-02	22½	559-0	22½	1032-5	55	12-04	57	483-4	58	806-1					
			25	35-02	24	1029-4	24	1029-4	0	10-82	2	460-3	3	771-4					
			30	30-85	27½	545-9	27½	1023-9	5	14-93	7	476-0	8	764-0					
			32½		27½	545-9	27½	1023-9	10	15-22	12	502-7	13	768-6					
			35	29-65	30	547-7	32½	1023-8	15	18-50	17	495-5	18	772-2					
			40	32-69	32½	557-4	36	1043-3	20	18-33	22	485-4	23	756-6					
42½		35	571-0	37½	1040-0	25	18-10	27	478-6	28	739-0								
45	31-01	37½	558-0	37½	1040-0	30	15-83	32	465-8	33	708-7								
50	32-17	40	550-6	42½	1037-5	35	15-19	37	445-3	38	672-9								
52½		42½	553-1	42½	1037-5	40	14-76	42	459-6	43	660-5								
55	33-27	45	570-2	46	1057-2	45	14-01	47	465-9	48	671-8								
Apr.	5	7	0	37-88	45	570-2	46	1057-2	50	19-24	52	472-2	53	683-7					
			5	39-97	47½	577-5	47½	1061-6	55	20-99	57	467-3	58	679-2					
			10	51-94	50	572-0	52½	1073-0	0	20-47	2	468-1	3	679-5					
			14	58-62	52½	575-3	52½	1073-0	5	16-23	7	461-8	8	692-3					
			15	58-12	55	594-7	56	1095-1	10	16-20	12	482-5	13	700-1					
			20	52-82	57½	618-8	57½	1104-0	15	15-79	17	518-4	18	697-2					
			25	58-25	0	627-2	1	1124-0	20	18-65	22	496-8	23	673-7					
			30	50-15	2½	612-7	2½	1124-9	25	19-17	27	473-4	28	628-0					
					5	610-4	7½	1113-3	30	23-90	32	472-9	33	625-0					
					7½	607-0	7½	1113-3	35	25-52	37	451-0	38	618-8					
					11½	558-5	11	1052-0	40	19-89	41	485-0	41	485-0					
					12½	547-6	12½	1029-6	45	12-00	47	479-2	48	667-7					
		15	568-0	16	1014-9	50	7-73	52	481-2	53	638-4								
		17½	602-8	17½	1028-4	55	2-15	57	486-5	58	619-8								
		20	608-2	21	1068-3	59	491-3	59	491-3										
		22½	584-2	22½	1074-3	1	500-6												
		25	553-0	26	1027-9														
		27½	505-1	27½	1008-5														
		30	467-3																

BIFILAR. $k=0.0001248$.

BALANCE. $k=0.000015$ approximately.

BIFILAR THERMOMETER, }
 BALANCE THERMOMETER, } April 5^d 7^h, { 50°-0
 } } 49°-5; 5^d 9^h, { 50°-2
 } } 50°-0

April 5^d. See notes on the Aurora, p. 61.

Göttingen Mean Time.	DECLINATION.		BIFILAR.		BALANCE.		Göttingen Mean Time.	DECLINATION.		BIFILAR.		BALANCE.	
	Min. of Obs.	Reading Reduced.	Min. of Obs.	Reading Cor-rected.	Min. of Obs.	Reading Cor-rected.		Min. of Obs.	Reading Reduced.	Min. of Obs.	Reading Cor-rected.	Min. of Obs.	Reading Cor-rected.
Apr. 5 11	m.	° ' "	m.	Sc. Div.	m.	Mic. Div.	Apr. 5 13	m.	° ' "	m.	Sc. Div.	m.	Mic. Div.
	5	25 5-80	2	500.4	3	634.6		35	25 38-51	34	460.6		
			6	534.0						35	455.5		
			7	544.5						36	452.7		
			8	546.1	8	688.1				37	466.2	37	502.4
	10	25 6-54	11	540.4						38	473.8	38	521.3
			12	533.3	13	718.0				39	491.3		
	15	25 4-55	16	513.7				40	6-41	40	501.9		
			17	516.1	18	711.4				41	517.9		
			19	520.7						42	526.9	42	507.3
	20	24 55-61	22	530.0	23	690.6				43	530.8	43	482.0
			24	536.4						44	531.9		
	25	24 56-21	27	534.4	28	656.7		45	12-90	45	528.0		
	30	25 2-03	32	526.1	33	624.5				46	516.0		
	35	5-31	37	522.1	38	620.5				47	507.1	47	388.9
	40	4-69	42	513.5	43	616.3				48	498.6	48	391.2
	45	4-39	47	510.6	48	619.0				49	488.4		
	50	5-94	52	507.6	53	626.1		50	20-16	50	484.1		
	55	6-54	57	504.2	58	627.1				51	484.3		
Apr. 5 12	0	8-65	2	501.9	3	623.5				52	484.5	52	417.2
	5	11-24	7	497.3	8	627.1				53	487.6	53	421.1
	10	10-85	12	498.3	13	634.4				54	490.7		
	15	9-76	17	498.2	18	624.4		55	18-18	55	489.1		
	20	11-13	22	498.0	23	616.4				56	487.5		
	25	12-87	27	496.1	28	610.8				57	485.4	57	413.9
	30	15-02	32	489.1	33	597.7				58	483.2	58	411.7
	35	15-32	37	481.2	38	572.7				59	479.0		
	40	14-60	42	471.8	43	551.2	Apr. 5 14	0	22-15	0	476.4		
	45	11-69	47	474.2	48	543.1				2	467.9	3	421.0
	50	10-55	52	485.0	53	562.1		5	20-68	4	468.5		
	55	11-26	57	482.3	58	583.0				5	468.0		
Apr. 5 13	0	14-55	2	458.9	3	579.8				6	467.7		
	5	15-32	7	435.9	8	541.1				7	469.4	7	442.0
	10	20-20	11	410.3				10	16-10	10	472.7	8	450.2
			12	413.5	12	504.0				11	474.3		
			13	422.2	13	486.9				12	475.8	13	462.1
			14	461.0						14	486.5		
	15	23-43	15	461.4				15	14-67	16	492.6		
			16	453.2						17	495.4		
			17	430.9	17	418.5				18	499.4	18	452.0
			18	428.0	18	400.9				19	499.6		
			19	448.2				20	20-58	21	493.3		
	20	31-38	20	478.3						22	489.0	22	427.3
			21	516.1						24	487.1	23	429.8
			22	539.7	22	480.5		25	23-91	26	479.7		
			23	559.0	23	487.2				27	477.5	27	440.5
			24	547.5						28	475.6	28	443.5
	25	30-85	25	537.8				30	23-48	30	475.5		
			26	520.6						32	477.5	32	471.4
			27	500.2	27	477.0				33	479.8	33	475.9
			28	487.3	28	473.5		35	18-05	35	483.9		
			29	469.6						37	487.8	37	491.2
	30	46-35	30	450.9						42	488.9	38	494.1
			31	448.7				40	15-76	42	488.9	43	496.2
			32	461.2	32	409.0				47	493.4	48	489.7
			33	465.3	33	419.2		45	14-76	47	493.4	48	489.7
								50	16-50	52	484.0	53	485.2

BIFILAR. $k=0.0001248$.

BALANCE. $k=0.000015$ approximately.

BIFILAR THERMOMETER, } April 5^d 12^h, { 48°-7; 5^d 13^h, { 48°-1; 5^d 14^h, { 47°-3
BALANCE THERMOMETER, } } { 49°-6; } { 49°-2; } { 49°-0

Göttingen Mean Time.	DECLINATION.		BIFILAR.		BALANCE.		Göttingen Mean Time.	DECLINATION.		BIFILAR.		BALANCE.		
	Min. of Obs.	Reading Reduced.	Min. of Obs.	Reading Cor-rected.	Min. of Obs.	Reading Cor-rected.		Min. of Obs.	Reading Reduced.	Min. of Obs.	Reading Cor-rected.	Min. of Obs.	Reading Cor-rected.	
Apr. 5 14	d. h.	m.	°	'	m.	Sec. Div.		d. h.	m.	°	'	m.	Sec. Div.	
		55	25	15.36	54	494.2		Apr. 6 2	10	25	39.72	12	511.0	
					56	500.5			15		40.03	17	539.6	
					57	501.5			20		38.35	22	539.1	
					58	501.9	57	486.7		30		39.29	32	543.5
					58	503.4	58	488.3		35		40.70	37	551.7
Apr. 5 15		0		20.43	0	499.4	2	505.2		40		41.14	42	549.5
					2	499.9	3	509.1		45		38.53	47	556.9
		5		18.48	7	497.6	8	528.4		50		39.90	52	556.5
		10		16.97	12	506.3	13	539.8	Apr. 6 3	55		42.19	57	553.0
					14	508.7				0		43.10	2	545.7
					17	509.2	18	544.5		5		41.24	7	545.4
					22	511.0	23	554.4		10		39.96	12	549.6
					27	514.2	28	564.6		15		37.89	17	555.6
					32	518.2	33	570.6		20		38.95	22	554.3
					37	520.7	38	578.2		25		40.17	27	553.5
					42	521.0	43	585.2		30		41.24	32	551.1
					47	516.8	48	590.5		35		39.83	37	548.1
					52	516.8	53	591.9		40		40.03	42	545.7
					57	517.0	58	591.2		45		40.20	47	543.0
Apr. 5 16		0		16.03	2	513.8	3	594.0		50		40.48	52	538.0
		5		14.92	7	514.0	8	593.9	Apr. 6 4	55		39.84	57	546.5
		10		14.48	12	515.3	13	593.6		0		40.91	2	555.1
					17	514.4	18	589.2		5		41.47	7	562.0
					22	509.9	23	586.9		10		41.69	12	554.8
					27	508.4	28	579.3		15		40.24	17	548.0
					32	510.8	33	574.5		20		39.43	22	558.4
					37	511.5	38	574.2		25		38.69		
					42	510.0	43	570.9	Apr. 6 5	0		39.39	2	543.8
					47	510.3	48	567.5	Apr. 6 6	0		32.69	2	543.4
					52	509.4	53	564.0		10		31.38	12	538.6
					57	508.2	58	564.6	Apr. 6 8	0		26.35	2	540.3
					0	505.0	3	564.0	Apr. 6 10	5		8.60	7	521.8
Apr. 5 17		5		14.92	7	504.3	8	562.9		10		6.05	12	522.1
		10		14.11	12	506.9	13	562.9		15		8.21	17	507.3
					17	508.9	18	562.3		20		4.52	22	517.0
					22	510.7	23	566.5		25		6.42	27	521.9
					27	513.8	28	561.6		30		6.05	32	528.3
					32	515.4	33	566.9		35		8.41	37	530.6
Apr. 5 18		0		14.23	2	515.4	3	566.9		40		12.33	42	531.0
Apr. 5 19		55		24.00	57	517.9	58	565.0		45		14.92	47	531.1
Apr. 5 20		0		23.63	2	519.2	3	563.5		50		14.62	52	536.5
Apr. 5 21		50		30.25	52	505.0	53	628.4		55		15.32	57	515.0
		55		29.14	57	503.7	58	632.0	Apr. 6 11	0		15.09	2	540.7
Apr. 5 22		0		28.64	2	504.6	3	633.5		5		16.43	7	534.5
					7	508.4	8	638.1		10		16.94	12	534.9
					12	508.6	13	643.9		15		17.62	17	534.3
										20		18.66	22	531.2
					32	505.5	33	653.3		25		18.84	27	528.7
Apr. 5 23		5		36.88	7	517.9	8	665.9		30		18.43	32	525.9
										35		17.05	37	523.6
Apr. 6 0		0	25	34.82	2	521.1	3	701.8		40		15.90	42	520.2
Apr. 6 1		0		39.44	2	532.8	3	695.6		45		15.02	47	518.7
		30		38.87	32	529.7	33	723.0		50		14.36	52	517.0
Apr. 6 2		0		41.98	2	533.5	3	746.1		55		14.11	57	508.7
		5		38.96	7	536.2	8	754.4	Apr. 6 12	0		14.28	2	504.5

BIFILAR. $k=0.0001248$.

BALANCE. $k=0.000015$ approximately.

BIFILAR THERMOMETER, } April 5^a 15^h, { 46° 6' ; 5^a 16^h, { 46° 0' ; 5^a 17^h, { 45° 7' ; 6^a 1^h, { 45° 7' ; 6^a 5^h, { 49° 8' ; 6^a 12^h, { 49° 2'
 BALANCE THERMOMETER, } April 5^a 15^h, { 48° 4' ; 5^a 16^h, { 47° 9' ; 5^a 17^h, { 47° 5' ; 6^a 1^h, { 47° 0' ; 6^a 5^h, { 49° 0' ; 6^a 12^h, { 49° 6'

Göttingen Mean Time.	DECLINATION.		BIFILAR.		BALANCE.		Göttingen Mean Time.	DECLINATION.		BIFILAR.		BALANCE.	
	Min. of Obs.	Reading Reduced.	Min. of Obs.	Reading Corrected.	Min. of Obs.	Reading Corrected.		Min. of Obs.	Reading Reduced.	Min. of Obs.	Reading Corrected.	Min. of Obs.	Reading Corrected.
Apr. 6 12	m. 5	25 13-55	m. 7	Sc. Div. 503.5	m. 8	Mic. Div. 610.6	Apr. 6 16	m. 40	25 27-16	m. 37	Sc. Div. 493.2	m. 38	Mic. Div. 549.0
	10	12-63	12	504.4	13	616.8		45	28-54	47	499.4	43	551.9
	15	11-12	17	513.3	18	629.8		55	28-00	57	515.6	48	552.6
	20	10-48	22	521.5	23	636.8		0	27-43	2	519.9	53	549.4
	25	11-15	27	527.4	28	640.5	Apr. 6 17	5	26-79	7	521.1	58	547.1
	30	11-89	32	529.5	33	638.4		25	22-62	27	529.5	3	547.0
	35	12-07	37	531.4	38	635.3		30	23-70	32	524.5	8	549.6
	40	12-16	42	529.1	43	633.2		45	21-58	47	527.1	28	563.8
	45	12-50	47	523.5	48	633.0		55	21-86	57	527.0	33	572.7
	50	13-10	52	523.2	53	631.4		0	21-68	2	527.6	48	592.2
	55	13-61	57	521.0	58	629.1	Apr. 6 18	10	22-05	12	529.2	58	602.0
Apr. 6 13	0	14-51	2	518.5	3	627.8	Apr. 6 19	0	21-91	2	530.1	3	607.8
	20	14-72	22	512.4	23	606.9	Apr. 6 20	0	21-91	2	530.1	13	643.5
	25	14-49	27	510.7	28	598.6		0	21-91	2	530.1	3	659.3
	30	14-16	32	509.4	33	592.7	Apr. 7 6	0	25 20-47	2	538.8	3	765.1
	35	14-31	37	508.3	38	587.8		5	20-70	7	549.0	8	763.2
	40	14-16	42	503.2	43	581.0		10	22-45	12	543.8	13	762.8
	45	14-23	47	495.8	48	568.9		15	23-29	17	546.4	18	760.1
	50	16-21	52	483.5	53	549.1	Apr. 7 8	0	19-10	2	538.7	3	743.9
	55	22-09	57	460.1	58	519.7		10	11-53	12	555.4	13	726.4
Apr. 6 14	0	30-89	2	452.1	3	467.4		15	3-58	17	576.2	18	709.3
	5	35-86	7	424.9	8	362.9		20	7-83	22	586.4	23	703.0
	10	41-22	12	422.3	13	290.9		25	12-74	27	576.4	28	703.9
			14	442.9				30	14-87	32	570.5	33	702.1
			16	429.2	18	273.2		35	18-48	37	558.2	38	701.3
			17	420.4				40	19-33	42	548.8	43	699.3
			19	434.4				45	20-41	47	543.7	48	699.2
					21	294.3		50	20-74	52	537.3	53	698.8
					22	449.2		55	20-67	57	532.5	58	696.8
					23	312.7		0	19-09	2	526.7	3	696.8
					28	351.3	Apr. 7 9	5	16-91	7	527.2	8	692.0
								10	14-48	12	527.8	13	690.8
								15	12-48	17	532.3	18	687.6
								20	12-16	22	534.0	23	687.0
								25	12-74	27	532.1	28	687.9
								30	12-70	32	530.1	33	691.1
								50	15-22	52	536.5	53	691.6
							Apr. 7 10	0	18-73	2	536.4	3	694.8
Apr. 6 15	0	27-29	2	508.8	3	412.1		0	25 23-90	2	544.5	3	626.0
	5	23-59	7	511.3	8	429.5		15	24-80	17	538.6	18	630.9
	10	20-84	12	511.0	13	435.7	Apr. 7 18	0	25 23-90	2	544.5	3	626.0
	15	18-15	17	508.6	18	446.5		15	24-80	17	538.6	18	630.9
	20	15-39	22	505.8	23	454.5	Apr. 8 4	0	25 29-24	2	542.9	3	716.3
	25	12-09	27	508.7	28	467.4	Apr. 8 5	55	15-76	57	557.9	58	779.0
	30	10-48	32	510.9	33	478.6	Apr. 8 6	0	16-62	2	561.0	3	773.8
	35	10-21	37	509.0	38	491.6		10	17-20	12	559.5	13	778.2
	40	10-41	42	510.0	43	502.6		25	18-80	27	546.0	28	783.7
	45	11-12	47	510.4	48	509.6		30	18-55	32	546.5	33	785.1
	50	12-16	52	507.0	53	510.3		35	19-83				
Apr. 6 16	0	11-98	2	510.7	3	520.5	Apr. 8 7	0	22-58	2	541.1	3	773.6
	10	15-66	12	502.2	13	531.1	Apr. 8 8	0	20-67	2	543.2	3	756.7
	15	18-01	17	496.6	18	537.1							
	20	19-80	22	492.9	23	542.8	Apr. 11 8	0	25 16-10	2	527.4	3	714.5
	25	22-29	27	492.5	28	546.7		10	12-87	12	533.2	13	720.2
	30	24-77	32	488.2	33	546.5							

BIFILAR. $k=0.0001248$.

BALANCE. $k=0.000015$ approximately.

BIFILAR THERMOMETER. } April 6^d 13^b, { 49° 0'; 6^d 14^b, { 48° 7'; 6^d 15^b, { 48° 2'; 6^d 16^b, { 47° 8'; 6^d 17^b, { 47° 2';
BALANCE THERMOMETER. } 49° 8'; 49° 5'; 49° 3'; 49° 4'; 48° 3'; 47° 0'; 47° 0'.

NOTES ON THE AURORA BOREALIS.

- d. h. m.
- March 29 An Auroral light was seen about 9^h to NNW., assuming the form of a segment of a circle, which became rather bright about 9^h 50^m, the light being homogeneous; at 10^h 50^m the light was more spotted, but no pencils were visible. At 10^h 25^m a meteoric light was seen, at first rather faint, proceeding from a point 1° to the south of *Zeta* Orionis (which was then just seen to about WSW. above the surrounding trees), passing between Castor and Pollux, and lost in a nebula in the back of Leo Minor. It became gradually brighter till about 10^h 35^m, when its brightness perhaps equalled the most vivid pencils of an aurora, and gradually diminished in intensity and length till altogether lost about 10^h 55^m. The breadth at Orion was about 1°, this being the brightest portion of the meteor, but increasing gradually upwards, filling the space between Castor and Pollux; the greatest length seen might be about 100°. There was no appearance of coruscations. This meteor, undoubtedly connected with the aurora, was singular in every way, whether we regard its form, position, isolation, or duration. The Aurora had disappeared at 12^h.
- April 5 9 30. Aurora, altitude about 35° or 40°; streamers and coruscations, brightest to N. by E.
- 9 40. Bright auroral arch stretches from W. to NE., altitude 30°, sending streamers *downwards* to N.
- 10 15. Splendid aurora, originally with a double arch, the greatest having an altitude of 80°, the other of 60°, spanning 150° of horizon. An auroral pencil seen frequently in the same position as that observed on March 29, but never having the same duration. The aurora is brightest to NE. by E., the E. extremity of the arch, although the moon being near that point renders it less obvious. A portion to the E., which is brightest, branches off in a cycloidal form. The arch is sometimes triple, the lowest being 10° altitude, with pencils of aurora between.
- 10 20. Arches more broken, and sending pencils up to the zenith. Arches broken into pencils, vivid from W., and directed a little to the S. of the zenith.
- 10 22. Arch altogether irregular to E. as if broken into small arches, with a bright mass to NNW. and NW., extending to the W. extremity of the arch, but broken at the N.; the dark space below having pencils occasionally.
- 10 25. Pencils to W., very bright; arch strangely irregular, the light space being about 15° broad, and generally cycloidal at the terminations on the horizon. A long pencil seen frequently to W. as at 15^m.
- 11 11. The arch now spans 130° of horizon, is 30° altitude, and 5° broad, with broad brushes of light below; the western extremity of the arch is bent inwards towards the north.
- 11 34. Arch only 10° altitude.
- 12 30. Arch spans 130°, 12° altitude, 6° or 7° broad, and the form is cycloidal: no pencils at present.
- 12 45. Again double arches, but close to each other; occasionally pencils from the NE. extremity. The moon is below the arch to WNW., and has a corona the breadth of its own diameter; the sky is beautifully clear, the stars appearing very brilliant, and no clouds are to be seen.
- 13 0-5. Strong pencils from the E. extremity of the arch. A new arch commencing at NNW., is springing up with the other; its altitude is 8°. The apex of the greater arch is about N. 5° W., and the breadth is increasing from 3° to 10°—much flickering.
- 14 0. Auroral arch much broken—altogether diminished; patch of cloud to NNW.
- April 5 15 30. The sky became quickly covered with scud—the aurora gone.
- April 7 14 0. An aurora to N., in the form of portion of an arch, 10° broad, reaching from W. to NNW.—*flickering*, but no pencils.
- 16 0. Faint auroral mass of light, 8° high and broad, variable in brightness, flickering.
- 16 35. Auroral light still flickering to NNW.—strong twilight.

Göttingen Mean Time.			DECLINATION.		BIFILAR.		BALANCE.		Göttingen Mean Time.			DECLINATION.		BIFILAR.		BALANCE.		
			Min. of Obs.	Reading Reduced.	Min. of Obs.	Reading Cor-rected.	Min. of Obs.	Reading Cor-rected.				Min. of Obs.	Reading Cor-rected.	Min. of Obs.	Reading Reduced.	Min. of Obs.	Reading Cor-rected.	Min. of Obs.
Apr. 11	8	15	25	12-56	17	534-3	18	723-6	Apr. 12	9	30	25	10-14	32	536-7	33	746-9	
		30		15-30	32	535-9	33	726-0			35		8-87	37	543-9	38	739-9	
Apr. 11	9	35		21-64	37	534-3	38	706-3			40		8-11	42	548-7	43	734-6	
Apr. 11	10	0		22-45	2	535-4	3	706-6			45		9-37	47	553-0	48	728-1	
											50		14-06	52	548-9	53	723-4	
Apr. 12	2	0	25	29-88	2	542-5	3	677-1	Apr. 12	10	55		16-53	57	545-8	58	718-9	
Apr. 12	3	45		28-23	47	561-6	48	680-7			0		18-55	2	542-2	3	712-5	
		50		28-47							5		19-86	7	538-9	8	709-0	
Apr. 12	4	0		28-07	2	559-5	3	690-1			10		21-34	12	535-0	13	706-9	
		15		27-43	17	548-4	18	696-4			15		22-52	17	530-1	18	708-0	
Apr. 12	5	45		30-05	47	560-6	48	740-2			20		22-18	22	528-8	23	708-7	
		50		30-25	52	555-1	53	748-5										
		55		33-54	57	533-3	58	767-1	Apr. 13	18	0	25	21-71	2	527-1	3	677-2	
Apr. 12	6	0		29-01	2	534-4	3	786-5	Apr. 13	19	0		23-90	2	509-6	3	613-6	
		5		24-37	7	542-9	8	800-8			20		25-39	22	525-5	23	624-5	
		10		16-92	12	566-1	13	800-7			35		25-45	37	535-7	38	629-4	
		15		24-17	17	557-7	18	810-1	Apr. 13	20	0		22-50	2	539-3	3	638-0	
		20		23-16	22	551-5	23	817-9										
		25		21-91	27	547-1	28	820-4	Apr. 14	10	0	25	21-58	2	533-1	3	646-0	
		30		21-86	32	543-5	33	821-6			10		19-26	12	534-8	13	657-9	
		35		22-45	37	543-9	38	826-5			15		19-22	17	535-3	18	662-5	
		40		21-81	42	546-6	43	822-9	Apr. 15	6	0	25	17-51	2	549-9	3	722-7	
		45		23-71	47	545-4	48	822-7			5		20-34	7	556-5	8	724-3	
		50		24-20	52	547-0	53	819-2	Apr. 15	8	10		21-32	12	552-7	13	725-2	
Apr. 12	7	0		24-99	2	541-7	3	825-4	Apr. 15	8	0		23-30	2	542-0	3	710-6	
		5		22-33	7	537-8	8	822-1										
		10		22-47	12	540-6	13	817-3	Apr. 18	6	0	25	25-72	2	549-8	3	739-6	
		15		22-85	17	542-9	18	811-5			25		25-39	27	558-3	28	744-4	
		20		22-56	22	540-4	23	810-1			30		23-12	32	560-4	33	750-4	
		25		21-62	27	541-4	28	807-4			35		24-38	37	561-5	38	754-7	
		30		22-45	32	542-2	33	807-8			50		20-03	52	547-4	53	782-2	
		35		23-32	37	538-6	38	808-3			55		16-97	57	545-3	58	802-3	
		40		23-36	42	533-5	43	807-6	Apr. 18	7	0		15-72	2	544-3	3	813-5	
		45		21-37	47	537-4	48	802-3			5		10-58	7	544-2	8	802-0	
		50		21-73	52	545-7	53	797-6			10		11-80	12	547-9	13	788-5	
		55		23-17	57	539-3	58	801-7			15		13-42	17	549-6	18	780-0	
Apr. 12	8	0		23-07	2	537-0	3	800-7			20		15-12	22	554-1	23	770-8	
		5		20-90	7	538-0	8	804-3			25		16-87	27	554-8	28	763-3	
		10		18-18	12	537-6	13	806-2			30		19-04	32	558-0	33	754-5	
		15		13-07	17	538-5	18	799-6			35		20-30	37	555-1	38	749-8	
		20		13-34	22	538-8	23	792-3	Apr. 18	8	0		20-57	2	554-1	3	731-9	
		25		15-14	27	539-7	28	787-1										
		30		15-64	32	534-4	33	784-4	May 6	6	0	25	24-96	2	516-6	3	660-2	
		35		15-34	37	535-4	38	778-8	May 6	8	0	25	21-64	2	518-0	3	701-7	
		40		15-83	42	537-2	43	769-9	May 6	9	40	24	58-08	42	437-2	43	532-5	
		45		16-78	47	534-5	48	766-0			45		24	50-67	47	443-8	48	525-1
		50		17-41	52	525-4	53	770-0			50		24	51-59	52	440-0	53	486-5
		55		14-15	57	528-8	58	769-5			55		24	57-94	57	448-5	58	461-1
Apr. 12	9	0		13-68	2	524-7	3	773-0	May 6	10	0	25	4-10	2	422-7	3	400-2	
		5		10-21	7	524-9	8	771-5			5		25	6-70	7	392-7	8	360-4
		10		6-88	12	529-5	13	761-4			10		25	6-91	12	416-6	13	375-8
		15		8-46	17	529-8	18	759-6			15		25	5-63	17	406-0	18	343-0
		20		9-99	22	525-8	23	757-2			20		25	4-89	21	374-7	22	269-2
		25		9-17	27	529-6	28	753-5										

BIFILAR. Before April 27, $k=0.0001248$; after April 27, $k=0.0001205$. BALANCE. $k=0.000015$ approximately.

BIFILAR THERMOMETER. } April 12^d 7^h, { 42°-6; 18^d 7^h, { 55°-0.
BALANCE THERMOMETER. } { 42°-2; { 54°-5.

May 6^d. Quite cloudy throughout this disturbance, but the aurora was observed near London by Sir J. Herschel, and described by him in the Athenæum, No. 811.

Göttingen Mean Time.		DECLINATION.		BIFILAR.		BALANCE.		Göttingen Mean Time.		DECLINATION.		BIFILAR.		BALANCE.		
		Min. of Obs.	Reading Reduced.	Min. of Obs.	Reading Corrected.	Min. of Obs.	Reading Corrected.			Min. of Obs.	Reading Reduced.	Min. of Obs.	Reading Corrected.	Min. of Obs.	Reading Corrected.	
May 6 10	d. h.	m.	° ' "	m.	Sc. Div.	m.	Mic. Div.	May 6 11	d. h.	m.	° ' "	m.	Sc. Div.	m.	Mic. Div.	
				24	370.7						37	25 34.85	37	226.6		
		25	8.00	27	344.6	28	196.1						38	221.2	38	465.1
		30	10.48	32	Out of field.	33	126.0				39	25 26.89	39	227.8		
		35	9.54								40	25 21.78	40	222.6		
						41	- 28.5						41	212.4	41	341.1
		43	18.32										42	216.9	42	311.0
		47	21.08	47	155.8	48	101.5						43	226.2	43	291.7
				48	168.5						44	25 11.82	44	250.1		
				49	185.2						45	25 9.05	45	268.8		
		50	24.25	50	184.1								46	260.0		
				51	199.1								47	256.0		
				52	222.3	52	220.5						48	241.2	48	276.1
				53	234.3								49	246.8		
				54	234.4	54	250.0				50	25 7.73	50	256.0	51	342.0
	55	21.04	55	221.8	56	274.5					52	271.5				
			56	236.6							53	294.0	53	288.0		
	57	19.67	57	228.2	58	317.0					54	310.5	54	322.0		
			58	221.8					55	24 43.10	55	342.4				
			59	240.8					56	24 42.43	56	348.1				
May 6 11		0	25 10.55	1	252.2	1	454.0	May 6 12				57	331.9	57	417.0	
		2	7.14	2	263.0							58	346.9	58	427.5	
				3	248.2	3	487.0				59	24 32.97	59	348.9		
				4	228.7						0	24 24.67	0	364.2		
		5	2.64	5	203.5						1	24 20.54	1	370.2		
				6	204.3						2	24 18.94	2	354.6		
				7	215.1	7	708.9						3	343.9	3	459.6
				8	235.1	8	754.1				4	24 11.29	4	322.1		
				9	257.7	9	803.0				5	24 4.92	5	303.7		
		10	16.97	10	286.3								6	299.5	6	480.7
				11	309.7	11	860.1				7	23 58.05	7	296.2		
				12	319.4								8	318.2	8	494.0
				13	310.5	13	903.9				9	23 52.13	9	333.9		
				14	301.6						10	23 51.71	10	335.7		
		15	29.14	15	280.5						11	23 52.64	11	334.1	11	471.7
				16	248.2	16	864.1						12	346.4		
		17	7.15	17	242.9						13		13	370.7	13	375.0
				18	208.7	18	940.2				14	24 2.39	14	372.6		
				19	164.2	19	973.4				15	24 6.42	15	364.0		
		20	20.03	20	89.0								16	373.2	16	275.0
			21	84.0	21	930.3			17	24 14.63	17	383.0				
			22	105.2	22	911.0					18	372.1	18	233.7		
			23	149.7	23	853.0			19	24 21.24	19	363.8				
	24	59.14	24	169.4					20	24 27.36	20	357.1	21	201.2		
	25	5.36	25	188.3							22	374.4				
			26	168.6	26	782.8					23	376.4	23	236.0		
	27	50.80	27	130.7					24	24 31.60	24	379.6				
			28	134.9	28	755.0			25	24 29.38	25	389.0				
			29	146.2							26	398.3	26	259.0		
	30	0.60	30	141.0							27	406.2				
			31	167.3							28	420.7	28	260.5		
			32	184.8	32	657.0			29	24 20.94	29	424.2				
			33	195.7					30	24 20.87	30	417.9				
	34	33.27	34	186.1							31	409.2	31	222.0		
	35	33.17	35	192.7					32	24 26.09	32	409.9				
			36	215.8	36	569.0					33	408.2	33	181.5		

BIFILAR. $k=0.0001205$.

BALANCE. $k=0.000015$ approximately.

BIFILAR THERMOMETER. } May 6^d 12^h, { 52°.4
BALANCE THERMOMETER. } 54°.0

May 6^d 10^h 45^m. The scale of the Bifilar Magnetometer having gone beyond the field of the reading telescope, the torsion circle was turned from 287° 44' to 291° 45'; the subsequent readings have been reduced so as to be comparable with those previous to the turning of the torsion circle.—(See *Introduction*.)

Göttingen Mean Time.	DECLINATION.		BIFILAR.		BALANCE.		Göttingen Mean Time.	DECLINATION.		BIFILAR.		BALANCE.	
	Min. of Obs.	Reading Reduced.	Min. of Obs.	Reading Cor-rected.	Min. of Obs.	Reading Cor-rected.		Min. of Obs.	Reading Reduced.	Min. of Obs.	Reading Cor-rected.	Min. of Obs.	Reading Cor-rected.
May 6 12	m. 34	o. 24 33-35	m. 34	Sc. Div. 400-4	m. 34	Mic. Div.	May 7 14	m. 0	o. 25 13-84	m. 7	Sc. Div. 462-7	m. 8	Mic. Div. 503-6
	35	24 36-31	35	401-2				5	13-88				
			36	411-3			May 10 2	0	25 30-16	2	514-7	3	664-3
			37	418-7						42	478-5	43	679-8
			38	412-8	38	125-0	May 10 4	0	26-13	2	518-1	3	696-9
	39	24 46-29	39	410-8			May 10 6	0	17-69	2	531-2	3	705-6
	40	24 47-92	40	409-4				15	16-68	17	535-6	18	707-3
			41	411-5	41	123-2		20	16-53	22	546-0	23	709-5
	42	24 49-89	42	416-0				30	19-29	32	528-2	33	717-7
			43	421-8	43	120-0		40	20-43	42	521-1	43	715-0
	44	24 55-81	44	420-4				45	23-77	47	517-2		
	45	24 57-89	45	429-9			May 10 8	0	23-48	2	512-0	3	708-6
			46	434-8	46	150-5							
			47	441-3			May 15 8	0	25 23-91	2	523-9	3	701-2
			48	446-7	48	175-0				10	533-7		
	49	25 7-65	49	449-2				25	22-77	27	516-0	28	727-8
	50	25 10-09	50	447-9				30	22-58	32	509-8	33	746-0
			51	447-9	51	207-1		40	21-79	42	512-7	43	789-1
			52	447-5				45	22-36	47	507-1	48	803-4
			53	449-9	53	235-7		55	19-22	57	502-2	58	840-6
			54	448-5			May 15 9	0	17-61	2	501-7	3	843-9
	55	25 14-48	55	448-7				5	16-33	7	499-0	8	844-1
			56	446-7				15	13-71	17	494-2	18	831-1
			57	445-5				20	12-13	22	496-0	23	814-6
			58	441-4	58	276-3		30	16-73	32	495-0	33	785-1
May 6 13	0	25 9-81	0	438-0			May 15 10	0	22-58	2	497-2	3	737-2
			1	437-4	1	330-0							
			4	454-4	3	351-0	May 29 18	0	25 28-67	2	509-6	3	615-9
	5	24 59-69	7	470-7	6	388-5		30	23-66	32	507-2	33	618-4
	7	24 58-25	9	480-0	8	402-0	May 29 19	0	19-89				
			10	484-8			May 29 20	0	24-53	2	493-3	3	646-0
			11	488-4	11	414-6		10	23-39	12	491-0	13	643-2
			12	492-1	12	420-6							
	15	25 2-33	15	491-7	16	425-6	June 2 20	0	25 15-79	2	493-8	3	653-1
	20	25 9-47	20	489-4	23	474-1	June 2 21	15	28-14	17	448-2	18	669-0
			24	487-8				30	30-74	32	479-9	33	650-0
	25	25 12-50	25	487-0	26	509-6		35	30-82	37	480-5	38	644-8
May 7 10	37	25 32-31	38	463-5	39	586-0	June 2 22	0	34-85	2	491-8	3	629-3
	40	30-45	41	460-0	42	580-0		10	34-61	12	493-8	13	626-4
May 7 12					58	531-7		30	33-42	32	489-0	33	629-6
May 7 13	0	19-96	2	452-7	3	522-6	June 2 23	0	31-66	2	486-5	3	638-4
	5	19-39	7	458-0	8	520-2		40	30-05	2	491-4		
	10	19-73	12	454-1	13	519-6	June 7 10	0	25 32-35	2	510-1	3	642-8
	15	19-15	17	447-8				10	28-23	12	515-9	13	638-6
	20	17-34	22	454-5	23	514-3		15	27-56	17	521-8	18	634-9
	25	15-47	27	461-6	28	508-6		20	27-87	22	524-7	23	629-4
	30	16-60	32	461-5	33	512-1		25	28-10	27	519-2	28	628-6
	35	14-70	37	459-3	38	501-2		30	26-89	32	513-2	33	627-6
	40	14-42	42	457-4	43	499-5		40	20-84	42	525-5	43	619-5
	45	13-61	47	459-1	48	496-9		45	20-48	47	512-2	48	616-4
	50	14-31	52	460-2	53	496-2		50	19-93	52	506-0	53	617-4
	55	15-09	57	460-1	58	495-7		55	18-68	57	499-5	58	617-5

BIFILAR. $k=0.0001205$.

BALANCE. $k=0.000015$ approximately.

BIFILAR THERMOMETER. } May 7^d 13^h, { 51°-2; 7^d 14^h, { 51°-0; 15^d 9^h, { 50°-9; June 2^d 23^h, { 49°-7.
BALANCE THERMOMETER. } { 51°-2; } { 51°-2; } { 50°-6; } { 49°-6.

May 6^d 13^h 5^m. The torsion circle was turned back from 291° 45' to 287° 41'; the readings till 13^h 25^m have been corrected by +3° 0 Sc. div., in order to make them comparable with those before 10^h 30^m.

Göttingen Mean Time.	DECLINATION.		BIFILAR.		BALANCE.		Göttingen Mean Time.	DECLINATION.		BIFILAR.		BALANCE.	
	Min. of Obs.	Reading Reduced.	Min. of Obs.	Reading Cor-rected.	Min. of Obs.	Reading Cor-rected.		Min. of Obs.	Reading Reduced.	Min. of Obs.	Reading Cor-rected.	Min. of Obs.	Reading Cor-rected.
June 7 11	m. 0	° 25 15.99	m. 2	Sc. Div. 496.8	m. 3	Mic. Div. 619.0	July 1 7	m. 45	° 25 19.20	m. 47	Sc. Div. 542.0	m. 48	Mic. Div. 678.1
	5	14.01	7	493.9	8	620.5		50	22.67	52	538.7	53	681.6
	10	13.03	12	495.0	13	619.7		55	25.16	57	529.5	58	680.7
	15	14.33	17	490.8	18	623.4	July 1 8	0	25.48	2	520.5	3	681.4
	20	16.24	22	492.5	23	624.7		5	25.78	7	517.5	8	679.9
	25	18.01	27	492.1	28	622.5		10	25.51	12	516.1		
	30	18.86	32	490.9	33	615.7		20	24.75	22	518.0	23	674.4
	35	19.22	37	490.1	38	608.3		30	26.62	32	509.9	33	676.8
	40	19.76	42	490.7	43	602.1		35	27.07	37	503.3	38	679.5
	45	18.57	47	490.8	48	597.2		40	26.13	42	502.5	43	678.1
	50	17.38	52	490.8	53	591.7		45	25.34	47	504.4		
	55	17.17	57	489.6	58	583.7	July 1 10	0	25.90	2	506.6	3	669.6
June 7 12	0	16.40	2	483.2	3	576.0							
	5	15.81	7	481.9			July 4 8	0	25 26.15	2	521.1	3	668.0
	10	14.62	12	483.9	13	578.0		50	13.81	52	530.3	53	668.6
	15	14.06	17	488.5	18	580.9		55	15.46	57	533.1	58	„
	20	14.43	22	491.6	23	587.1	July 4 9	0	17.94	2	526.4	3	670.0
	25	14.60	27	496.7	28	593.2		5	19.10	7	520.4	8	671.5
	30	15.97	32	499.3	33	598.5		10	19.46	12	516.7	13	670.5
	35	17.20						15	19.91	17	514.5	18	„
June 7 18	0	21.95	2	484.6	3	633.7		20	21.10	22	514.5	23	„
	30	25.43	32	485.3	33	636.2		30	23.24	32	512.3	33	„
June 7 20	0	25.92	2	489.1	3	642.6	July 4 10	0	25.86	2	512.5	3	667.4
June 9 20	0	25 19.54	2	518.7	3	655.8	July 24 6	0	25 25.32	2	567.3	3	621.0
	10	20.25	12	508.2	13	658.3		10	22.25	12	540.9	13	635.2
	15	20.54	17	507.8	18	657.2		15	22.63	17	541.1	18	637.1
	20	21.02	22	505.8	23	655.6		20	22.69	22	544.6	23	„
June 9 22	0	24.06	2	497.2	3	657.5		25	23.14	27	539.1	28	641.5
								30	22.97	32	534.5	33	644.6
								35	22.11	37	527.4	38	646.8
June 11 22	0	25 25.19	2	477.4	3	663.7		40	22.62	42	529.2	43	647.2
June 11 23	5	29.48	7	467.5	8	673.9		45	22.58	47	536.3	48	„
June 12 0	0	27.83	2	492.2	3	663.8		50	22.38	52	546.7		
										53	538.8		
June 13 6	0	25 24.60	2	492.5	3	731.0	July 24 7	0	23.53	2	522.6	3	656.4
	30	22.67	32	539.2	33	712.9		5	21.27	7	518.7	8	659.6
	35	24.65	37	534.2	38	710.6		10	24.67	12	521.0	13	„
	40	25.21	42	530.3	43	709.9		15	25.01	17	524.7		
	45	25.73	47	523.9	48	710.3				22	516.0	23	672.6
	50	26.62	52	516.8	53	710.9		25	25.95	27	525.5	28	670.4
	55	26.10	57	511.2	58	709.1		30	25.14	32	523.8	33	672.6
June 13 7	0	26.08	2	512.6	3	708.0		35	25.07	37	525.3	38	675.8
June 13 8	0	26.62	2	510.4	3	695.9		40	24.67	42	533.8	43	„
								45	24.67	47	528.1	48	675.6
June 30 18	0	25 25.14	2	488.8	3	582.2		50	24.58	52	523.8	53	679.5
	30	23.26	32	494.4	33	600.5	July 24 8	0	22.99	2	524.7	3	685.1
June 30 19	0	24.55	2	491.5	3	612.3		5	18.43	7	511.5	8	710.9
	30	19.22	32	495.9	33	618.3	July 24 9	5	20.37	12	506.7	13	709.1
June 30 20	0	16.40	2	484.5	3	636.9		15	20.28	17	507.2	18	711.8
June 30 21			17	475.6	18	657.3		20	19.13	22	503.2	23	694.9
	20	19.15						25	19.09	27	494.2	28	677.4
	25	19.81	27	483.9	28	652.1		30	17.88	32	499.3	33	654.2
June 30 22	0	20.92	2	481.4	3	647.6		35	17.47	37	495.0	38	659.0
July 1 6	0	25 28.64	2	517.8	3	666.5		40	12.74	42	474.8	43	631.7

BIFILAR. $k=0.0001205$.

BALANCE. $k=0.000015$ approximately.

BIFILAR THERMOMETER. } June 7^d 11^h, { 56°·2; 7^d 12^h, { 52°·0; 13^d 7^h, { 54°·8. July 4^d 9^h, { 68°·4; 24^d 9^h, { 61°·8.
BALANCE THERMOMETER. } 56°·0; } 50°·0; } 54°·0. } 67°·0; }

Göttingen Mean Time.	DECLINATION.		BIFILAR.		BALANCE.		Göttingen Mean Time.	DECLINATION.		BIFILAR.		BALANCE.	
	Min. of Obs.	Reading Reduced.	Min. of Obs.	Reading Cor-rected.	Min. of Obs.	Reading Cor-rected.		Min. of Obs.	Reading Reduced.	Min. of Obs.	Reading Cor-rected.	Min. of Obs.	Reading Cor-rected.
July 24 9	m. 45	° 25 1-01	m. 47	Sc. Div. 490.5	m. 48	Mic. Div. 628.3	July 25 2	m. 50	° 25 29-17	m. 52	Sc. Div. 572.1	m. 53	Mic. Div. 922.1
	50	24 53-72	52	524.3	53	634.7		55	25-29	57	584.8	58	937.4
	55	24 52-22	57	528.7	58	599.6	July 25 3	0	33-07	2	598.8	3	942.0
July 24 10	0	24 55-11	2	507.9	3	593.6		5	41-04	7	580.8	8	975.4
	5	24 57-04	7	493.4	8	608.2		10	28-08	12	569.6	13	944.3
	10	24 56-95	12	493.2	13	636.0		11 ¹ / ₂	21-91				
	15	24 52-72	17	513.2	18	638.3		15	29-88	17	568.1	18	891.3
	20	24 57-22	22	516.7	23	626.4		17	33-54				
	25	25 6-67	27	507.9	28	629.0		20	35-89	22	559.1		
	30	5-91	32	508.5	33	627.9		23	39-39			23	898.1
	35	6-77	37	508.2	38	622.5		24	37-37				
	50	14-43	52	514.9	53	606.7		25	34-73	27	547.6	28	907.1
	55	15-66	57	515.3	58	604.9		30	30-51	32	557.2	33	895.0
July 24 11	0	17-20	2	518.0	3	601.1		35	35-69	37	560.6	38	899.4
	5	20-25	7	511.2	8	603.3		40	32-27	42	586.3	43	899.4
	15	22-29	17	516.4	18	604.8		45	46-94	47	558.7	48	928.1
								46	48-53				
July 24 22	0	25 31-03	2	444.1	3	674.9		50	35-73	52	543.1	53	920.3
	5	31-93	7	438.0	8	678.6		54	23-48				
	10	32-57	12	436.0	13	678.6	July 25 4	55	24-03	57	572.8	58	895.4
	15	33-22	17	439.0	18	677.0		0	28-12	2	609.2	3	905.5
	20	34-83	22	441.5	23	675.8		4	41-41				
	25	34-28	27	442.4	28	674.3		5	41-11	6	599.5		
	30	34-72	32	440.3	33	„				7	597.1	8	947.3
	35	33-47	37	438.5	38	„		9	34-11				
	40	32-58	42	438.8	43	681.3		10	28-72	12	597.5	13	871.0
	45	31-01	47	441.7	48	676.1				14	594.4		
	50	29-96	52	447.0	53	675.1		15	40-35				
July 24 23	0	31-36	2	451.5	3	„		16	45-95	17	574.8	18	839.6
	15	31-56	17	458.4	18	677.2		19	52-67				
	30	34-82	32	462.5	33	684.6		20	51-29	21	550.4		
	35	35-56	37	463.0	38	688.0				22	552.7	23	920.6
	50	34-66	52	473.2	53	696.0		24	38-96				
July 25 0	0	33-15	2	467.2	3	702.6		25	35-49	26	566.1		
	25	34-52	27	475.0	28	722.2				27	567.7	28	890.9
July 25 1	10	32-05	12	497.6	13	745.3		29	39-27				
	15	31-32	17	488.8	18	756.2		30	40-91	31	553.7		
	20	32-69	22	486.1	23	766.0				32	554.2	33	931.5
	25	35-89	27	495.8	28	771.8		34	31-56				
	30	38-69	32	494.0	33	776.9		35	29-60	36	562.2		
	35	35-62	37	505.0	38	782.0				37	568.1	38	914.2
	40	33-96	42	520.3	43	787.2		39	32-62				
	45	34-92	47	519.4	48	790.0		40	33-76	41	594.9		
	50	34-65	52	519.6	53	795.1				42	599.8	43	917.7
	55	36-90	57	518.7	58	803.6		44	33-74				
July 25 2	0	35-59	2	517.5	3	814.0		45	33-60	46	627.7		
	5	36-03	7	517.9	8	836.3				47	626.7	48	944.4
	10	32-24	12	516.5	13	861.5		49	39-02				
	15	30-16	17	524.6	18	853.3		50	39-63	51	602.8		
	20	30-37	22	536.7	23	848.2				52	606.6	53	875.5
	25	34-85	27	538.0	28	849.8		54	38-92				
	30	36-63	32	537.1	33	862.4		55	44-70	56	587.1		
	35	33-89	37	541.1	38	874.8				57	580.4	58	820.6
	40	33-44	42	551.0	43	882.3		59	54-73	59	571.7		
	45	30-29	47	570.2	48	908.9	July 25 5	0	56-04	0	566.9		

BIFILAR. $k=0.0001205$.

BALANCE. $k=0.000015$ approximately.

BIFILAR THERMOMETER. } July 24^d 11^h, { 61°-0; 25^d 1^h, { 62°-2; 25^d 3^h, { 64°-4
 BALANCE THERMOMETER. } { 60°-5; 25^d 1^h, { 60°-7; 25^d 3^h, { 63°-9

Göttingen Mean Time.		DECLINATION.		BIFILAR.		BALANCE.		Göttingen Mean Time.		DECLINATION.		BIFILAR.		BALANCE.		
		Min. of Obs.	Reading Reduced.	Min. of Obs.	Reading Cor-rected.	Min. of Obs.	Reading Cor-rected.			Min. of Obs.	Reading Reduced.	Min. of Obs.	Reading Cor-rected.	Min. of Obs.	Reading Cor-rected.	
d.	h.	m.	° /	m.	Sc. Div.	m.	Mic. Div.	d.	h.	m.	° /	m.	Sc. Div.	m.	Mic. Div.	
July	25	5		1	562.1	1	851.0	July	25	10	55 25 13-51	56	478.4			
		2	25 52.70	2	556.0							57	484.7	58	602.7	
		4	50.05	3	552.2	3	877.4					59	488.0			
		5	48.33	4	553.6			July	25	11	0 12-60	2	486.6	3	649.3	
		7	46.76	5	554.4							4	481.9			
				6	556.3	6	891.3				5	11.77	7	480.8	8	671.6
				7	557.0							9	483.5			
				8	558.4	8	895.6				10	10.55	12	487.0	13	679.3
		10	44.43	10	559.3						15	14.03	17	484.6	18	671.6
		12	40.53	12	559.9						20	16.95	22	482.8	23	674.5
				13	561.1	13	900.5				25	19.27	27	482.0	28	676.9
		15	39.52	15	568.4	18	905.7				40	20.68	42	479.0	43	667.8
		20	37.15	22	568.3	23	904.8				50	21.88	52	484.9	53	667.6
		25	34.12	27	566.7	28	920.2	July	25	18	0 15-03	2	466.0	3	642.9	
		30	29.38	32	555.7	33	908.5				20	15.19	22	485.9	23	640.7
		35	32.51	37	553.6	38	907.0				30	15.32	32	484.1	33	639.0
		40	37.61	42	524.6	43	876.4									
				43	523.8			Aug.	3	4	0 25 29-08	2	535.3	3	604.0	
		44	29.31	44	524.3						20	27.22	22	524.9	23	615.6
		45	28.35	45	526.6			Aug.	3	6	0 21-08	2	512.7	3	637.0	
				46	525.9	46	862.3									
				47	525.9	48	844.2				0 25 20-82	2	466.7	3	625.5	
		50	30.40	52	512.9	53	817.5	Aug.	3	22	35 26-19	37	474.5	38	619.3	
		55	31.73	57	512.8	58	811.3				0 31-43	2	490.3	3	601.8	
July	25	6		2	519.4	3	812.8	Aug.	4	0	47 34-90	48	508.0	49	608.0	
		0	31.96	7	520.8	8	812.7				20 29-38	22	522.2	23	663.8	
		5	30.74	17	530.6	18	798.9	Aug.	4	1	45 31-36	47	512.4	48	660.1	
		15	25.58	22	530.4	23	784.6				0 29-42	2	512.9	3	682.0	
		20	28.27	27	526.5	28	789.1	Aug.	4	2	0 32-78	2	519.3	3	685.9	
		25	30.42	42	520.7	43	784.9	Aug.	4	4	20 21-24	22	536.4	23	747.1	
		40	22.38	47	510.0	48	772.6	Aug.	4	5	30 24-37	32	518.4	33	776.5	
		45	19.63	52	518.0	53	769.8				35 21-95	37	518.4	38	782.2	
		50	20.34	57	518.3	58	771.7				40 19-26	42	518.7	43	784.5	
July	25	8		2	508.0	3	736.0				45 18-48	47	522.5	48	789.6	
July	25	10		2	474.3	3	663.7				50 15-83	52	516.0	53	„	
		10	18.97	12	479.7	13	658.8				55 11-24	57	532.6	58	778.6	
		15	21.91	17	469.3	18	643.1	Aug.	4	6	0 13-68	2	537.3	3	772.5	
		20	21.28	21	463.5						5 17-15	7	532.2	8	767.0	
				22	460.2	23	826.6				10 19-37	12	528.6	13	759.8	
		25	20.07	26	462.3						15 22-02	17	524.3	18	752.0	
				27	462.1	28	611.9				25 24-37	27	516.8	28	738.1	
				29	445.9			Aug.	4	8	0 21-24	2	517.4	3	679.1	
		30	19.80	31	448.2											
				32	442.1	33	562.3	Aug.	8	18	0 25 37-51	2	461.8	3	475.2	
				34	437.5						10 38-08	12	466.6	13	462.9	
		35	20.28	36	425.7						15 42-41	17	456.6	18	451.6	
				37	431.9	38	520.6				20 43-74	21	468.0			
				39	457.1							22	472.3	23	448.7	
		40	17.83	41	465.3							24	476.7			
				42	470.2	43	566.7				25 43-49	26	480.3			
				44	476.5							27	481.8	28	447.6	
		45	13.71	47	486.6	48	576.1				30 43-80	31	487.8			
				49	476.3							32	490.5	33	442.0	
		50	13.44	52	460.2	53	567.0				35 43-12	36	496.2			
				54	467.2							37	498.7	38	437.9	

BIFILAR. $k=0.0001205$.

BALANCE. $k=0.000015$ approximately.

BIFILAR THERMOMETER. } July 25^a 11^b, { 64°.4
BALANCE THERMOMETER. } { 64°.2

Göttingen Mean Time.	DECLINATION.		BIFILAR.		BALANCE.		Göttingen Mean Time.	DECLINATION.		BIFILAR.		BALANCE.	
	Min. of Obs.	Reading Reduced.	Min. of Obs.	Reading Cor-rected.	Min. of Obs.	Reading Cor-rected.		Min. of Obs.	Reading Reduced.	Min. of Obs.	Reading Cor-rected.	Min. of Obs.	Reading Cor-rected.
Aug. 8 18	d. h. m.	° ' "	m.	Sec. Div.	m.	Mic. Div.	Sept. 1 2	d. h. m.	° ' "	m.	Sec. Div.	m.	Mic. Div.
	40	25 42-23	42	503-7	43	427-6		3	25 31-22	5	507-7
	45	39-20	46	508-6				24	31-00	22	517-9
			47	508-6	48	421-5				25	500-0
	50	37-77	52	511-3	53	426-7		46	32-42	44	518-6
Aug. 8 19	55	35-62	57	513-1	58	429-9	Sept. 1 3	10	33-62	11	511-9
	0	33-71	2	512-5	3	436-1		35	28-97	33	493-6
	5	32-95	7	512-8	8	445-5				35	490-9
	20	32-15	22	512-7	23	457-2				37	496-6
	25	30-10	27	504-6	28	482-9				56	521-2
	45	23-06	47	502-2	48	512-0		58	28-30	59	529-1
Aug. 8 20	0	19-49	2	498-1	3	537-5	Sept. 1 4	0	27-78	2	525-1
Aug. 8 21	20	20-20	22	486-3	23	595-8				16	525-9
	25	20-21	27	483-5	28	596-7		18	27-10	19	513-8
Aug. 8 22	0	21-95	2	478-8	3	605-6				39	502-9
								40	29-35	42	516-7
Aug. 22 0	0	25 31-76	2	498-8	3	663-3				4	530-1
Aug. 22 1	5	39-39	7	490-0			Sept. 1 5	7	29-20	8	532-4
	10	37-03	12	477-7	13	675-3				27	506-3
	15	36-38	17	483-6	18	673-0		30	23-01	29	513-2
	20	38-11	22	492-1	23	671-7				47	514-2
	25	39-59	27	505-4	28	665-5		50	20-12	50	497-8
	30	40-89	32	509-6	33	664-7	Sept. 1 6	0	19-42	2	491-8
	35	36-63	37	481-4	38	675-3				8	495-9
	40	35-67	42	497-8	43	665-1		9	17-12	11	503-8
	45	37-07	47	496-9	48	"		46	23-05		"
	50	36-60	52	494-9	53	668-8	Sept. 1 8	0	17-60	2	511-8
	55	34-65	57	490-3	58	672-9					
Aug. 22 2	0	33-54	2	487-4	3	675-0	Sept. 1 20	0	25 32-55	2	478-0
	20	33-98	22	530-0	23	"		15	31-72	17	489-6
	25	33-84	27	529-8	28	683-7		30	30-37	32	496-4
	30	32-48	32	516-8	33	689-2		45	28-17	47	503-1
	35	31-46	37	517-2	38	692-1	Sept. 1 22	0	24-41	2	483-5
			42	526-3			Sept. 2 0	0	26-83	2	485-6
	45	32-87	47	532-3	48	"		57	28-44	56	492-8
	50	33-78	52	536-6	53	"	Sept. 2 1	18	28-35	18	497-6
			57	524-3						38	505-6
Aug. 22 3			2	521-3						55	489-7
	5	33-17	7	524-1	8	705-2	Sept. 2 2	0	28-05	2	492-4
			17	514-6						11	500-0
	40	33-51	42	533-1	43	708-3				14	510-1
	45	31-50	47	512-0	48	715-6				28	507-0
	50	31-07	52	505-0	53	720-4				31	497-6
			57	495-2						48	505-1
Aug. 22 4	0	31-22	2	504-7	3	718-9	Sept. 2 3	10	27-37	11	498-1
	10	30-42	12	505-1	13	716-6				29	493-1
Aug. 22 5	15	28-64	17	533-9	18	613-2	Sept. 2 4	0	26-60	2	503-8
	35	27-33	37	523-6	38	628-5				21	517-6
Aug. 22 6	0	26-94	2	519-0	3	731-3	Sept. 2 5	19	22-42	20	499-2
										38	513-1
Sept. 1 0	0	25 28-59	2	504-7	Sept. 2 6	0	20-36	2	507-5
	59	29-95	58	499-8
Sept. 1 1	0		2	499-8	Sept. 18 10	0	25 7-65	2	519-0	3	796-7
	21	30-73	22	505-5		10	5-65	12	530-1	13	787-1
	43	31-22	42	513-5		15	4-28	17	539-5	18	779-7
Sept. 1 2	0	31-89	2	514-3		20	5-33	22	539-7	23	776-1

BIFILAR. $k=0.0001205$.

BALANCE. $k=0.000015$ approximately.

BIFILAR THERMOMETER. } Aug. 8^d 19^h, { 60°·4; 22^d 1^h, { 58°·7
 BALANCE THERMOMETER. } 60°·5; 58°·3

Aug. 22^d. A faint Aurora observed for a short period this evening at Edinburgh.
 Sept. 1^d—2^d. Observations made during experiments to determine the temperature correction of the Balance Magnet.

Göttingen Mean Time.	DECLINATION.		BIFILAR.		BALANCE.		Göttingen Mean Time.	DECLINATION.		BIFILAR.		BALANCE.	
	Min. of Obs.	Reading Reduced.	Min. of Obs.	Reading Cor-rected.	Min. of Obs.	Reading Cor-rected.		Min. of Obs.	Reading Reduced.	Min. of Obs.	Reading Cor-rected.	Min. of Obs.	Reading Cor-rected.
Sept. 18 10	h. m.	° ' "	m.	Se. Div.	m.	Mic. Div.	Oct. 4 23	m.	° ' "	m.	Se. Div.	m.	Mic. Div.
	25	25 6.79	27	539.7	28	774.9		5	25 32.87	7	471.9	8	769.0
	30	9.89	32	538.0	33	772.5		10	32.53	12	470.0	13	763.0
	35	12.14	37	535.7	38	766.8		15	32.35	17	473.3	18	781.5
	40	11.64	42	533.2	43	760.7		20	31.46	22	480.1	23	798.4
	45	11.28	47	527.3	48	753.1		25	32.27	27	480.5	28	798.7
	50	10.88	52	521.3	53	748.2		30	32.10	32	485.5	33	779.6
	55	10.50	57	515.4	58	754.9		35	32.10	37	490.5	38	749.8
Sept. 18 11	0	9.47	2	513.7	3	761.7		40	32.62	42	491.0	43	763.6
	5	10.08	7	510.0	8	762.9		45	32.80	47	492.3	48	750.9
	10	9.57	12	508.1	13	759.4		50	32.91	52	491.0	53	771.0
	15	8.90	17	502.9	18	763.6		55	32.51	57	492.4	58	769.8
	20	8.40	22	495.9	23	765.7	Oct. 5 0	0	32.53	2	493.6	3	770.2
	25	8.97	27	492.8	28	769.3	Oct. 5 4	0	27.33	2	513.2	3	798.4
	30	11.73	32	492.2	33	776.0	Oct. 5 5	25	16.44	27	501.6	28	853.2
	35	15.99	37	487.6	38	786.0		30	16.53	32	505.9	33	854.9
	40	19.37	42	489.7	43	786.0		45	20.61	47	507.6	48	856.7
	45	22.50	47	491.6	48	782.0	Oct. 5 6	0	25.31	2	505.2	3	849.6
	50	23.27	52	493.5	53	774.3	Oct. 5 7	55	15.19				
	55	22.11	57	503.1	58	752.5	Oct. 5 8	0	11.05	2	507.4	3	802.9
Sept. 18 12	0	19.93	2	515.0	3	737.2		5	3.01	7	523.7	8	783.7
	5	20.90	7	523.3	8	726.1		10	2.74	12	535.9	13	771.4
	10	23.16	12	520.4	13	721.3		15	6.97	17	537.0	18	763.6
	15	24.27	17	521.3	18	704.4		20	11.47	22	523.8	23	762.9
	20	24.67	22	519.1	23	707.1		25	10.01	27	524.1	28	752.5
	25	26.22	27	518.0	28	708.5		30	11.32	32	516.2	33	751.4
	30	26.86	32	516.4	33	710.0		35	13.17	37	506.7	38	755.3
	35	26.33	37	513.5	38	711.3	Oct. 5 10	0	19.67	2	506.0	3	766.3
Sept. 19 6	0	25 19.29	2	509.0	3	838.7	Oct. 16 10	0	25 12.36	2	549.3	3	828.9
	20	9.99	22	508.5	23	854.5		5	18.68	7	544.0	8	826.8
	25	8.03	27	512.6	28	858.4		10	21.28	12	537.0	13	823.0
	30	7.95	32	515.5	33	862.2		15	22.63	17	519.6	18	821.7
	35	9.47	37	514.7	38	863.0		20	21.29	22	514.0	23	819.5
	40	9.27	42	510.9	43	861.7		25	17.41	27	521.2	28	815.4
	45	8.53	47	510.0	48	860.1		30	15.88	32	527.3	33	810.4
	50	7.56	52	513.9	53	850.5		35	17.18	37	525.0	38	810.4
	55	6.47	57	516.3	58	852.8		40	17.76	42	523.5	43	810.4
Sept. 19 7	0	6.68	2	518.3	3	851.4		45	17.88				
	15	6.03											
	20	7.02	22	520.7	23	848.3	Oct. 17 2	0	25 18.41	2	492.4	3	901.7
Sept. 19 8	0	14.01	2	507.3	3	846.9		5	16.73	7	503.1	8	898.2
Sept. 19 10	0	19.89	2	511.2	3	780.5		10	21.02	12	505.2	13	900.6
	10	23.36	12	501.3	13	774.8		15	20.40	17	506.0	18	901.6
	20	20.20	22	515.6	23	762.0		20	21.24	22	505.8	23	900.2
	25	18.99	27	517.9	28	755.5		25	22.32	27	506.4	28	899.8
	30	15.00	32	521.6	33	757.6		55	24.69	57	506.1	58	875.8
	35	11.53	37	528.7	38	754.7	Oct. 17 4	0	25.32	2	508.5	3	884.6
	40	10.48	42	537.9	43	749.7							
	45	12.20	47	534.8	48	750.5	Oct. 26 4	0	25 22.99	2	500.8	3	879.6
	50	14.03	52	530.8	53	751.2		10	17.78	12	502.1	13	893.0
	55	15.77	57	526.3	58	754.3		15	16.38	17	504.5	18	897.7
Sept. 19 11	0	17.02	2	520.8	3	757.4		20	14.11	22	510.8	23	897.6
								25	14.36	27	518.0	28	894.9
Oct. 4 22	0	25 23.93	2	486.7	3	781.0		30	15.84	32	522.1	33	892.6
Oct. 4 23	0	32.13	2	469.6	3	771.8	Oct. 26 6	0	19.26	2	498.8	3	920.7

BIFILAR. $k=0.0001205$.

BALANCE. $k=0.000013$ approximately.

BIFILAR THERMOMETER. } Sept. 18^d 11^h, { 62° 0'; 18^d 12^h, { 61° 6'; 19^d 11^h, { 62° 0'. Oct. 4^d 23^h, { 58° 0'.
 BALANCE THERMOMETER. } { 62° 5'; { 62° 5'; { 62° 0'. { 58° 0'.

Sept. 18^d 10^h 50^m. A band of auroral light, about 10° altitude, seen among the clouds to NNW.
 Sept. 18^d 11^h 45^m. Auroral light still visible, but very faint.
 Sept. 18^d 12^h 40^m. The aurora has now almost entirely disappeared.
 Sept. 19^d 10^h 0^m. Lightish to NNW. Auroral light?
 Sept. 19^d 11^h 0^m. All traces of auroral light have vanished, the sky nearly clear.

Göttingen Mean Time.		DECLINATION.		BIFILAR.		BALANCE.		Göttingen Mean Time.		DECLINATION.		BIFILAR.		BALANCE.	
		Min. of Obs.	Reading Reduced.	Min. of Obs.	Reading Cor-rected.	Min. of Obs.	Reading Cor-rected.			Min. of Obs.	Reading Reduced.	Min. of Obs.	Reading Cor-rected.	Min. of Obs.	Reading Cor-rected.
Oct. 26	6	56	25 5.63	2	531.9	3	876.7	Nov. 2	11	20	25 14.15	22	480.0	23	784.4
Oct. 26	7	0	9.89	2	531.9	3	876.7	Nov. 2	11	25	15.14	27	476.9	28	775.5
		5	16.03	7	524.5	8	873.9	Nov. 2	11	30	13.08	32	504.0	33	762.0
		10	18.84	12	522.7	13	867.3	Nov. 2	11	35	11.76	37	515.0	38	743.6
		20	22.80	22	504.8	23	864.5	Nov. 2	11	40	15.16	42	514.2	43	738.8
		25	20.81	27	498.4	28	864.9	Nov. 2	11	45	17.20	47	496.8	48	729.4
		30	19.80	32	498.7	33	866.2	Nov. 2	11	50	17.71	52	492.5	53	731.4
		35	19.24	37	499.3	38	868.4	Nov. 2	11	55	16.53	57	491.1	58	735.7
		40	18.45	42	502.5	43	867.5	Nov. 2	12	0	14.46	2	491.0	3	737.1
Oct. 26	8	0	20.34	2	508.3	3	861.7	Nov. 2	12	5	12.68	7	492.9	8	726.2
Oct. 26	9	55	0.67	57	505.2	58	835.4								
Oct. 26	10	0	1.14	2	507.2	3	834.1	Nov. 2	22	0	25 21.10	2	498.0	3	825.5
		5	2.25	7	506.4	8	835.5	Nov. 2	22	15	22.25	17	496.8	18	827.1
		10	3.68	12	505.0	13	836.3	Nov. 2	23	0	24.94	2	495.0	3	821.2
		15	4.93	17	505.0	18	835.2	Nov. 3	0	0	26.45	2	493.5	3	837.7
		20	5.94	22	508.7	23	833.0	Nov. 3	1	0	27.61	2	503.6	3	854.8
		25	6.89	27	507.2	28	830.7	Nov. 3	2	0	25.51	2	503.7	3	859.6
		30	7.53	32	509.8	33	833.0	Nov. 3	6	0	21.28	2	514.4	3	840.8
		35	8.46	37	511.8	38	826.6	Nov. 3	7	30	17.20	32	508.0		
		40	9.32	42	511.6	43	824.1	Nov. 3	8	0	13.71	2	517.6	3	836.5
		45	9.94	47	512.7	48	818.7	Nov. 3	8	10	15.74	12	514.5	13	828.8
		50	10.06	52	512.1	53	815.5	Nov. 3	10	0	21.05	2	510.2	3	832.6
								Nov. 3	10	10	20.84				
Oct. 27	0	0	25 25.90	2	493.9	3	850.1	Nov. 13	8	0	25 15.30	2	502.6		
Oct. 27	1	10	22.08	12	488.5	13	866.4	Nov. 13	8	10	10.57	12	497.9		
Oct. 27	2	0	24.17	2	515.1	3	857.8	Nov. 13	8	15	8.86	17	507.6		
								Nov. 13	8	20	10.76	22	504.3		
Oct. 30	10	0	25 17.76	2	507.3	3	854.1	Nov. 13	10	45	9.73	47	501.9		
		10	19.10	12	517.7	13	853.9	Nov. 13	10	0	16.87	2	504.1	3	805.0
Oct. 31	6	0	25 18.86	2	513.8	3	846.2	Nov. 16	10	0	25 15.19	2	504.5	3	882.3
Oct. 31	7	55	12.00	57	525.3	58	822.8	Nov. 16	10	15	16.53				
Oct. 31	8	0	12.27	2	525.2	3	823.0	Dec. 1	10	0	25 10.31	2	507.9	3	868.1
		10	15.36	12	520.3	13	822.6	Dec. 1	10	10	12.40	12	507.6	13	867.6
		15	15.66	17	515.6	18	822.6	Dec. 1	10	25	13.95	27	508.4	28	866.0
		20	15.19	22	514.5	23	822.6	Dec. 6	8	0	25 19.37	2	511.8	3	852.0
		30	15.64	32	510.0	33	824.4	Dec. 6	8	8	506.7				
Oct. 31	10	0	17.88	2	509.3	3	824.4	Dec. 6	8	10	10.80	12	512.5	13	851.1
		10	16.06	12	510.6	13	833.5	Dec. 6	8	15	10.09	17	515.5	18	854.1
Nov. 2	10	0	25 17.07	2	511.6	3	830.2	Dec. 6	8	20	10.75	22	516.6	23	855.8
		10	13.30	12	505.3	13	833.1	Dec. 6	8	25	11.98	27	515.6	28	853.5
		15	12.67	17	504.7	18	830.3	Dec. 6	8	30	14.11	32	513.5	33	860.1
		20	8.84	22	502.8	23	831.8	Dec. 6	10	0	19.15	2	502.2	3	850.2
		25	6.37	27	499.8	28	830.3	Dec. 6	11	25	11.22	27	513.1	28	817.8
		30	4.75	32	505.8	33	825.2	Dec. 6	11	30	11.76				
		35	2.98	37	513.8	38	819.7	Dec. 6	12	20	15.05				
		40	4.22	42	516.9	43	816.5	Dec. 8	6	0	25 25.14	2	510.6	3	874.8
		45	5.78	47	514.6	48	811.9	Dec. 8	6	10	25.27	12	504.8	13	889.5
		50	6.30	52	510.4	53	806.3	Dec. 8	6	15	24.58	17	504.8	18	895.6
		55	6.23	57	505.5	58	800.2	Dec. 8	6	20	24.80	22	502.4	23	902.3
Nov. 2	11	0	6.27	2	502.5	3	793.5	Dec. 8	6	25	23.39	27	501.1	28	898.1
		5	7.42	7	502.9	8	788.3								
		10	10.77	12	494.7	13	788.8								
		15	13.00	17	481.1	18	790.8								

BIFILAR. Before Nov. 10^d, $k=0.0001205$; after Nov. 10^d, $k=0.0001300$.
 BALANCE. Before Nov. 13^d, $k=0.000013$ approximately; after Nov. 13^d, $k=0.000014$ approximately.

BIFILAR THERMOMETER. } Oct. 26^d 7^h, { 45° 0' } Nov. 2^d 11^h, { 42° 3' } 2^d 12^h, { 42° 1' } Dec. 6^d 11^h, { 44° 4' }
 BALANCE THERMOMETER. } 44° 5' } 42° 5' } 42° 5' } 44° 9'

Oct. 26^d 9^h 50^m. Aurora in the form of a low arch, 8° high, stretching from NW to N. At 10^h 0^m it was fainter. No aurora was visible at 9^h.
 Oct. 26^d 10^h 55^m. Aurora imperceptible; the north is partially covered with clouds.
 Nov. 2^d 10^h 30^m. Milky like to N.; perhaps auroral light, but doubtful on account of moonlight.
 Nov. 13^d 8^h. The Balance Magnetometer not in adjustment. An auroral light to N. like the reflection of a great fire as seen below a thick mass of clouds.

Göttingen Mean Time.	DECLINATION.		BIFILAR.		BALANCE.		Göttingen Mean Time.	DECLINATION.		BIFILAR.		BALANCE.	
	Min. of Obs.	Reading Reduced.	Min. of Obs.	Reading Cor-rected.	Min. of Obs.	Reading Cor-rected.		Min. of Obs.	Reading Reduced.	Min. of Obs.	Reading Cor-rected.	Min. of Obs.	Reading Cor-rected.
Dec. 8 6	m. 30	° 25 22-05	m. 32	Sec. Div. 500-5	m. 33	Mic. Div. 911-9	Dec. 10 13	m. 5	° 25 11-19	m. 7	Sec. Div. 503-7	m. 8	Mic. Div. 788-0
	35	21-88	37	502-3	38	916-0		10	12-27	12	504-9	13	791-3
	40	21-91	42	501-2	43	916-0		15	13-17	17	505-7	18	790-6
	45	20-88						20	14-48	22	509-2	23	792-4
Dec. 8 8	0	17-88	2	502-8	3	947-9		25	15-37	27	506-6	28	793-0
			7	490-3	8	954-9		30	15-52	32	503-9	33	795-1
	10	13-61	12	493-1	13	946-7		35	15-56	37	503-3	38	797-1
	15	12-43	17	502-1	18	931-0		40	16-38	42	500-4	43	801-0
	20	15-12	22	500-6	23	923-0		45	16-91	47	500-4	48	803-3
	25	12-90	27	500-8	28	928-0		50	17-47	52	503-5	53	805-8
	30	11-98	32	496-1	33	927-0		55	17-88	57	504-1	58	806-3
	35	6-57	37	501-7	38	902-8	Dec. 10 14	0	17-20	2	502-3	3	802-1
	40	10-85	42	502-7	43	893-8							
	45	15-79	47	501-4	48	883-8	Dec. 11 6	0	25 22-72	2	513-1	3	869-3
	50	19-27	52	497-9	53	872-0		12	20-60	9	520-0	9	866-0
	55	25-68	57	491-4	58	860-7		15	21-95	17	514-4	18	870-4
Dec. 8 9	0	25 25-27	2	475-7	3	851-8		35	24-44	37	520-0	38	865-2
	5	25 18-85	7	467-2	8	861-3		40	25-14	42	520-5	43	865-1
	10	25 3-25	12	478-7	13	854-1		45	26-35	47	515-5	48	865-4
	15	24 57-12	17	491-1	18	843-0		50	25-12	52	514-9	53	864-3
	20	24 56-15	22	494-5	23	841-8		55	24-94	57	517-5	58	860-8
	25	24 54-91	27	496-9	28	840-9	Dec. 11 7	0	23-50	2	517-3	3	859-5
	30	24 56-73	32	503-3	33	841-0		5	23-10				
	35	24 59-22	37	506-2	38	839-8	Dec. 11 8	0	6-05	2	530-6	3	867-9
	40	25 2-53	42	505-3	43	839-0		5	7-11	7	529-0	8	865-0
	45	25 5-73	47	499-0	48	840-8		10	8-51	12	529-8	13	860-0
	50	25 7-26	52	493-5	53	844-5		15	10-48	17	527-4	18	857-8
	55	25 7-62	57	492-5	58	847-0		20	12-43	22	526-6	23	855-7
Dec. 8 10	0	25 8-23	2	494-4	3	851-2		25	13-89	27	525-1	28	852-3
	5	25 10-34	7	496-8	8	851-5		30	15-41	32	525-4	33	848-5
	10	25 13-14	12	498-5	13	853-1	Dec. 11 10	0	19-34	2	510-6	3	852-5
								10	18-06	12	507-6	13	856-4
Dec. 8 18	0	25 22-55	2	530-7	3	816-0		15	17-59	17	510-0	18	855-7
	15	23-29	17	529-7	18	815-5		20	15-99	22	512-4	23	853-8
	40	24-33	42	530-4	43	814-2		25	15-16	27	513-3	28	855-2
								30	15-02	32	514-6	33	853-5
Dec. 9 8	0	25 9-84	2	527-3	3	852-5		35	15-10	37	515-4	38	853-1
	5	12-80	7	533-3	8	847-3		40	13-89	42	516-5	43	849-2
	10	14-40	12	536-2	13	839-6		45	12-45	47	517-1	48	845-5
	15	13-93	17	529-6	18	842-5		50	10-58	52	515-3	53	847-3
	20	10-52	22	521-4	23	841-6		55	11-05	57	518-4	58	844-8
	25	8-20	27	528-8	28	836-7	Dec. 11 11	0	10-83	2	516-1	3	845-5
	30	7-48	32	534-8	33	832-3		5	11-35	7	514-5	8	845-0
	35	10-25	37	533-8	38	833-8		10	13-10	12	521-3	13	837-9
	40	12-60	42	528-4	43	836-4		15	15-52	17	534-3	18	827-9
	45	15-72	47	521-3	48	839-5		20	20-41	22	535-4	23	818-9
	50	15-39	52	518-0	53	839-3		25	22-43	27	531-5	28	811-4
	55	17-00	57	511-9	58	843-2		30	23-68	32	521-8	33	808-0
Dec. 9 9	0	17-96	2	509-7	3	845-5		35	23-32	37	511-1	38	806-4
	5	18-43	7	509-5	8	846-5		40	20-32	42	507-0	43	802-0
Dec. 9 10	0	18-15	2	510-4	3	849-0		45	16-28	47	512-7	48	794-2
								50	13-96	52	515-1	53	793-7
Dec. 10 12	50	25 11-87	52	495-8	53	778-6		55	14-95	57	518-8	58	791-3
	55	10-58	57	500-2	58	781-9	Dec. 11 12	0	16-01	2	525-4	3	788-7
Dec. 10 13	0	10-41	2	503-7	3	783-0							

BIFILAR. $k=0.0001300$.

BALANCE. $k=0.000014$ approximately.

BIFILAR THERMOMETER. } Dec. 8^d 9^h, { 46°-8; 47°-5; 9^d 9^h, { 46°-8; 47°-5; 10^d 13^h, { 46°-0; 46°-5; 10^d 14^h, { 46°-0; 47°-0; 11^d 11^h, { 48°-0; 48°-7.

Dec. 10^d. (Sunday). It having been observed that the magnets were disturbed to-day, observations were commenced at midnight (Monday morning).

Dec. 11^d 10^h 20^m. Auroral light to NNW.

Göttingen Mean Time.	DECLINATION.		BIFILAR.		BALANCE.		Göttingen Mean Time.	DECLINATION.		BIFILAR.		BALANCE.	
	Min. of Obs.	Reading Reduced.	Min. of Obs.	Reading Corrected.	Min. of Obs.	Reading Corrected.		Min. of Obs.	Reading Reduced.	Min. of Obs.	Reading Corrected.	Min. of Obs.	Reading Corrected.
Dec. 11 12	5	25 17-72	7	524-5	8	787-5	Dec. 13 8	10	25 15-19	12	507-0	13	879-5
	10	16-46	12	525-0	13	781-5		15	16-37	17	507-7	18	878-8
	15	13-91	17	525-2	18	779-0		30	17-07	32	507-5	33	873-1
Dec. 11 18	0	21-29	2	505-7	3	826-1	Dec. 13 10	0	21-28	2	512-6	3	849-7
	14	20-60						10	18-55	12	518-7	13	846-1
	20	22-74	22	512-2	23	827-6		15	19-36	17	517-3	18	843-6
	25	23-44	27	512-2	28	830-1		20	19-58	22	516-8	23	845-3
	30	23-27	32	511-2	33	829-7							
Dec. 11 19	5	19-09	7	519-0			Dec. 21 10	0	25 8-55	2	522-1	3	820-7
	10	20-77	12	517-8	13	836-0		5	9-81	7	520-8	8	823-4
	15	20-92	17	515-9	18	836-6		10	11-44	12	516-6	13	827-8
	20	20-30	22	516-4				15	13-15	17	513-4	18	830-2
Dec. 11 20	0	21-28	2	518-9	3	834-0		20	13-79	22	512-6	23	831-2
Dec. 12 2	0	27-87	2	510-7	3	851-8		25	15-03	27	512-6	28	"
	20	29-39	22	499-9	23	865-6		30	14-78	32	513-1	33	830-2
	25	26-72	27	493-5	28	869-1		35	14-11	37	516-6	38	827-5
	30	24-28	32	498-1	33	872-0		40	13-41	42	519-5	43	824-9
	35	24-10	37	498-6	38	876-2		45	13-00	47	519-5	48	823-5
	40	21-44	42	499-8	43	876-3		50	13-08	52	518-3	53	822-7
	45	20-88	47	505-3	48	878-4		55	13-14	57	516-1	58	823-4
	50	20-57	52	496-2	53	883-0	Dec. 21 11	0	13-24	2	514-3	3	821-0
	55	18-57	57	498-6	58	881-7	Dec. 21 12	0	16-98	2	516-2	3	818-4
Dec. 12 3	0	17-14	2	505-1	3	"							
	5	17-17	7	510-2	8	"	Dec. 26 23	0	25 21-24	2	510-9	3	829-4
	10	18-82	12	515-6	13	884-0		35	23-86	37	514-7	38	828-2
	15	20-50	17	512-8	18	"	Dec. 27 0	0	22-65	2	513-5	3	830-1
	20	20-75	22	512-8	23	883-2	Dec. 27 6	0	20-81	2	503-1	3	876-4
Dec. 12 4	0	21-98	2	515-7	3	887-4		10	21-04	12	501-2	13	883-4
	10	23-70	12	512-3	13	887-4		15	20-68	17	501-3	18	885-7
Dec. 12 6	0	14-78	2	517-4	3	869-9		20	20-85	22	504-1	23	887-3
	5	16-43	7	511-2	8	870-4		25	22-11	27	502-6	28	889-3
	10	14-98	12	506-7	13	870-1		30	20-52	32	502-4	33	891-2
	15	12-83	17	509-6	18	868-9		35	20-52	37	501-2	38	894-8
	20	11-91	22	513-3	23	865-8		50	19-61	52	504-3	53	902-5
	25	10-18	27	519-2	28	863-3	Dec. 27 7	0	20-58	2	512-3	3	894-5
	30	10-88	32	522-9	33	864-5		5	21-71	7	514-8	8	893-4
	35	12-68	37	519-0	38	864-4		10	23-06	12	512-3	13	894-6
	40	12-48	42	517-5	43	863-9		15	23-70	17	511-4	18	892-1
	45	12-61	47	514-0	48	866-1		20	23-32	22	509-3	23	892-9
	50	14-51	52	511-3	53	868-3		25	22-45	27	507-5	28	892-3
	55	14-98	57	512-9	58	868-4		30	21-04	32	507-3	33	890-2
Dec. 12 7	0	15-23	2	509-2	3	"		40	18-26	42	509-3	43	888-7
	5	14-06	7	512-2	8	866-1		45	17-88	47	510-3	48	888-3
	10	13-61	12	513-0	13	"		50	17-38	52	512-3	53	886-2
	15	13-30	17	514-8	18	"	Dec. 27 8	0	17-92	2	513-6	3	885-1
	20	15-02	22	512-6	23	868-1							
Dec. 12 8	0	16-55	2	506-2	3	871-1	Dec. 27 22	0	25 24-60	2	511-7	3	834-7
Dec. 12 10	0	19-39	2	513-9	3	826-1		30	24-99	32	512-7	33	830-3
	15	16-01	17	512-1	18	826-9	Dec. 27 23	0	23-07	2	516-5	3	827-5
	20	15-22	22	511-4	23	829-2	Dec. 28 0	0	23-07	2	511-9	3	839-6
	25	15-70	27	509-4	28	831-8	Dec. 28 1	15	25-78	17	511-0	18	843-8
	30	16-13	32	508-3	33	832-9		20	26-40	22	512-9	23	843-7
								25	23-88	27	509-5	28	842-9
Dec. 13 8	0	25 13-62	2	504-8	3	881-4		30	24-99	32	508-9	33	846-0
	5	14-55	7	507-3	8	879-4		35	26-62				

BIFILAR. $k=0.0001300$.

BALANCE. $k=0.000014$ approximately.

BIFILAR THERMOMETER. } Dec. 11^d 12^h, { 48°-0; 12^d 3^h, { 47°-0; 12^d 7^h, { 47°-1; 21^d 11^h, { 53°-9; 21^d 12^h, { 53°-1;
 BALANCE THERMOMETER. } { 48°-9; 47°-5; 48°-0; 21^d 11^h, { 55°-0; 21^d 12^h, {;
 27^d 7^h, { 46°-9; 47°-0; 28^d 1^h, { 44°-2; 44°-9.

Dec. 12^d 2^h 20^m. *et seq.* The Declination and Bifilar Magnets vibrating irregularly 2 to 5 Scale division.
 Dec. 21^d 10^h. Continued from the Term Observations.
 Dec. 27^d 6^h. Faint Auroral light to N.?

Göttingen Mean Time.			DECLINATION.		BIFILAR.		BALANCE.		Göttingen Mean Time.			DECLINATION.		BIFILAR.		BALANCE.	
			Min. of Obs.	Reading Reduced.	Min. of Obs.	Reading Cor- rected.	Min. of Obs.	Reading Cor- rected.				Min. of Obs.	Reading Cor- rected.	Min. of Obs.	Reading Reduced.	Min. of Obs.	Reading Cor- rected.
Dec. 28	1		m.	° /	m.	Sc. Div.	m.	Mic. Div.	Dec. 28	2		m.	° /	m.	Sc. Div.	m.	Mic. Div.
			37	25 28-03	37	510-9	38	851-7				5	25 27-40	7	511-3	8	876-6
			40	28-72								10	27-22	12	511-8		
			42	27-96	42	510-8	43	853-7				15	26-67	17	512-0	18	879-5
			45	28-37								20	26-59	22	510-7		
			47	27-90	47	509-9	48	855-1				25	25-95	27	509-9	28	880-4
			50	27-83	52	502-1	53	859-2				30	25-38	32	509-3		
			55	23-97	57	500-5	58	864-4				35	24-69	37	509-1		
Dec. 28	2		0	23-32	2	506-0	3	866-3				40	23-81	42	508-5	43	881-3
			5	22-35	7	511-8	8	865-4				45	22-47	47	509-6	48	880-9
			10	23-23	12	511-6	13	866-6				50	21-31	52	511-8	53	880-4
			15	23-93	17	513-1	18	866-8				55	21-26	57	514-4		
			20	25-39	22	510-5	23	869-3	Dec. 28	4		0	21-41	2	515-3	3	878-0
			25	26-08	27	509-8	28	869-4									
			30	26-77	32	514-7	33	868-9	Dec. 29	10		0	25 12-50	2	508-6	3	837-9
			35	28-52								10	13-84	12	511-7	13	838-5
			37	29-31	37	516-3	38	870-0				15	14-75	17	511-2		
			40	30-51								20	15-19	22	511-8	23	838-2
			42	30-65	42	516-0	43	871-9				35	16-47	37	514-4	38	836-8
			45	30-62	47	513-9	48	873-1				40	17-07				
			50	30-76													
			52	30-85	52	512-3			Dec. 30	10		0	25 15-22	2	514-2	3	849-8
			55	30-74	57	505-9	58	876-3				10	16-38	12	514-6	13	849-4
Dec. 28	3		0	28-80	2	507-6						25	16-60	27	515-4		

BIFILAR. $k=0.0001300$. BALANCE. $k=0.000014$ approximately.

BIFILAR THERMOMETER. }
 BALANCE THERMOMETER. } Dec. 29^d 10^h 1^m 3^s, {
 { 47°.2



OBSERVATIONS OF MAGNETIC DIP.

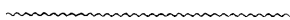

MAKERSTOUN OBSERVATORY,

1843.

Göttingen Mean Time, Middle of Observation.	Dura- tion of Observ- ation.	NEEDLE.			FACE OF CIRCLE E.		FACE OF CIRCLE W.		Mean.	A. dipping Minus B. dipping.	Observed Dip.	Observer's Initial.
		Num- ber.	Tem- pera- ture.	End dip- ping.	Mark on Needle		Mark on Needle					
					E.	W.	E.	W.				
Jan. 2 21 0	58	1	33	{ A	69 52.0	73 36.5	69 32.5	73 25.5	71 36.62	+ 34.37	71 19.44	W
				{ B	72 57.0	69 27.0	72 27.5	69 17.5	71 2.25			
Jan. 6 6 0	50	1	59	{ B	73 1.0	69 28.0	73 0.0	69 19.0	71 12.00	+ 19.87	71 21.94	W
				{ A	69 42.0	73 37.0†	69 25.0	73 23.5	71 31.87			
Jan. 9 22 45	25	1	47	{ A	69 52.0	73 37.0	69 28.0	73 26.5	71 35.87	+ 29.62	71 21.06	B
				{ B	73 0.0	69 28.0	72 44.0	69 13.0	71 6.25			
Jan. 13 7 5	45	1	52	{ B	72 58.0	69 29.0	72 50.0	69 15.5	71 8.12	+ 26.00	71 21.12	B
				{ A	69 46.0	73 43.0	69 29.0	73 18.5	71 34.12			
Jan. 16 22 45	65	1	53	{ A	69 51.0	73 36.5	69 26.0	73 12.0	71 31.37	+ 22.12	71 20.31	W
				{ B	72 59.5	69 36.0	72 43.0	69 18.5	71 9.25			
Jan. 20 3 5	43	1	58	{ B	73 7.5	69 39.5	73 45.0	69 15.0	71 11.75	+ 21.00	71 22.25	W
				{ A	70 13.5	73 8.0	69 54.0	72 55.5	71 32.75			
Jan. 23 23 5	70	1	56	{ A	70 14.5	73 13.0	69 51.0	72 55.5	71 33.50	+ 22.75	71 22.12	W
				{ B	72 56.5	69 44.5	72 36.0	69 26.0	71 10.75			
Jan. 28 3 20	57	1	57	{ B	72 58.5	69 40.0	72 40.0	69 26.5	71 11.25	+ 20.37	71 21.44	W
				{ A	70 9.0	73 16.5	69 44.0	72 57.0	71 31.62			
Jan. 30 22 35	25	1	57	{ A	70 0.0	73 16.0	69 38.5	73 30.5	71 36.25	+ 29.00	71 21.75	B
				{ B	73 1.0	69 30.5	72 46.5	69 11.0	71 7.25			
Feb. 3 3 35	35	1	53	{ B	73 7.0	69 17.5	72 51.0	69 14.5	71 7.50	+ 29.00	71 22.00	B
				{ A	70 2.5	73 25.5	69 36.0	73 22.0	71 36.50			
Feb. 6 23 0	50	1	50	{ A	70 3.5	73 34.5	69 37.0	73 20.0†	71 38.75	+ 31.50	71 23.00	W
				{ B	72 58.5	69 27.5	72 39.0	69 24.0	71 7.25			
Feb. 10 3 10	50	1	55	{ B	72 56.0	69 47.5	72 35.5	69 11.0	71 7.50	+ 26.00	71 20.50	W
				{ A	70 15.5	73 14.0	69 52.5	72 52.0	71 33.50			
Feb. 13 22 45	40	1	45	{ A	70 16.0	73 9.0	69 49.0	72 58.0	71 33.00	+ 21.38	71 22.31	B
				{ B	73 8.0	69 41.0	72 47.5	69 10.0†	71 11.62			
Feb. 17 3 35	28	1	55	{ B	73 7.5	69 27.0	72 49.0	69 11.0	71 8.62	+ 29.13	71 23.19	B
				{ A	70 8.5	73 23.5	69 48.0	73 11.0	71 37.75			
Feb. 20 22 40	48	1	47	{ A	70 15.0	73 23.0	69 44.0	73 5.0	71 36.75	+ 23.13	71 25.19	W
				{ B	72 59.5	69 46.5	72 38.0	69 30.5	71 13.62			
Feb. 27 22 32	35	1	46	{ B	72 56.0	69 46.0	72 31.5	69 25.5	71 9.75	+ 24.87	71 22.19	B
				{ A	70 2.5	73 27.0	69 33.0	73 16.0	71 34.62			
Mar. 3 5 30	40	1	54	{ A	70 2.0	73 22.0	69 32.5	73 6.5	71 30.75	+ 19.50	71 21.00	B
				{ B	73 10.0	69 36.5	72 46.0	69 12.5	71 11.25			
Mar. 10 3 30	60	1	52	{ B	73 6.5	69 35.0	72 49.0	69 19.0	71 12.37	+ 22.38	71 23.56	W
				{ A	70 19.0	73 14.5	69 47.5	72 58.0	71 34.75			
Mar. 13 22 35	30	1	50	{ A	70 15.0	73 18.0	69 46.0	72 55.5	71 33.62	+ 27.00	71 20.12*	B
				{ B	73 2.0	69 40.0	72 31.0	69 13.5	71 6.62			
Mar. 17 3 20	35	1	47	{ B	73 0.0	69 44.5	72 39.5	69 15.0	71 9.75	+ 23.00	71 21.25*	B
				{ A	70 4.5	73 28.0	69 32.5	73 6.0	71 32.75			
Mar. 20 23 0	65	1	46	{ A	70 4.0	73 27.5	69 36.5	73 6.5	71 33.62	+ 21.87	71 22.69	W
				{ B	73 3.0	69 45.0	72 37.0	69 22.0	71 11.75			
Mar. 24 3 30	53	1	46	{ B	73 2.5	69 44.5	72 35.5	69 12.5	71 8.75	+ 26.87	71 22.19	W
				{ A	70 12.5	73 21.5	69 43.5	73 5.0	71 35.62			
Mar. 31 3 10	45	1	54	{ A	70 11.5	73 22.0	69 41.0	73 8.0	71 35.62	+ 24.37	71 23.44	W
				{ B	73 0.5	69 45.5	72 30.0	69 29.0	71 11.25			
Apr. 3 23 0	60	1	46	{ B	72 57.0	69 46.0	72 31.0	69 25.5	71 9.87	+ 24.25	71 22.00	W
				{ A	70 7.5	73 19.0	69 46.5	73 3.5	71 34.12			
Apr. 7 3 0	40	1	50	{ A	70 11.5	73 20.0	69 47.5	73 4.0	71 35.75	+ 26.00	71 22.75	W
				{ B	72 59.5	69 44.0	72 33.5	69 22.0	71 9.75			
Apr. 10 23 15	45	1	36	{ B	72 59.5	69 43.0	72 32.0	69 20.0	71 8.62	+ 26.63	71 21.94	W
				{ A	70 9.0	73 22.0	69 45.0	73 5.0	71 35.25			
Apr. 14 3 20	...	1	53	{ A	70 9.0	73 26.5	69 40.0	73 3.5	71 34.75	+ 23.63	71 22.94	B
				{ B	73 4.5	69 44.0	72 38.5†	69 17.5	71 11.12			
Apr. 18 0 40	45	1	53	{ B	73 7.0	69 39.5	72 39.5	69 12.0	71 9.50	+ 24.62	71 21.81*	B
				{ A	70 10.0	73 31.5	69 31.0	73 4.0	71 34.12			

* Observations considered good.

† Observations considered bad or doubtful.

Jan. 16^d 22^b. In changing the poles of the needle the wrong end was at first taken, so that A. north was strengthened; the poles were afterwards reversed.

Göttingen Mean Time, Middle of Observation.			Dura- tion of Observ- ation.	NEEDLE.			FACE OF CIRCLE E.		FACE OF CIRCLE W.		Mean.	A. dipping <i>Minus</i> B. dipping.	Observed Dip.	Observer's Initial.
				Num- ber.	Tem- pera- ture.	End dip- ping.	Mark on Needle		Mark on Needle					
							E.	W.	E.	W.				
Apr. 21	3 10	48	1	57	{ B A	73 6.5 70 4.0	69 46.0 73 27.0	72 37.5 69 44.0	69 14.5 73 3.5	71 11.12 71 34.62	+23.50	71 22.87	W	
Apr. 24	23 0)	47	1	47	{ A B	70 1.0 73 20.0	73 30.0 69 16.0	69 41.0 72 51.0	73 12.5 68 59.0	71 36.12 71 6.50	+29.62	71 21.31	B	
Apr. 25	3 0)				{ B A	73 35.5 70 1.0	69 19.0 73 38.0	72 52.0 69 29.0	68 40.5 73 14.0	71 8.75 71 35.50	+28.75	71 21.12*	B	
May 1		45	1	...	{ A B	70 9.0 73 22.5	73 41.0 69 31.5	69 28.0 72 35.0	73 12.5 69 11.0	71 37.62 71 10.00	+27.62	71 23.81	W	
May 5	3 25	53	1	48	{ B A	73 28.5 70 8.5	69 33.5 73 36.5	72 36.5 69 34.0	68 54.0 73 13.5	71 8.12 71 38.12	+30.00	71 23.12	W	
May 15	22 45				{ A B	70 8.0 73 16.5	73 33.5 69 32.0	69 33.0 72 36.5	73 7.5 69 15.0	71 35.50 71 10.00	+25.50	71 22.75	W	
May 20	3 0	...	1	51	{ B A	73 17.5 70 13.5	69 37.0 73 28.0	72 40.0 69 39.0	69 5.5 73 0.5	71 10.00 71 35.25	+25.25	71 22.62*	B	
May 26	3 25	40	1	58	{ A B	70 9.5 73 21.0	73 27.5 69 20.0	69 38.0 72 50.0	73 6.5 69 1.0	71 35.37 71 8.00	+27.37	71 21.69*	W	
May 30	23 15	60	1	48	{ B A	73 30.5 70 11.0	69 13.0 73 26.5	72 57.0 69 41.5	68 56.5 73 9.0	71 9.25 71 37.00	+27.75	71 23.12	W	
June 2	3 40	55	1	56	{ A B	70 13.0 73 22.0	73 30.0 69 34.0	69 46.0 72 47.5	73 7.5 69 8.0	71 39.12 71 12.87	+26.25	71 26.00†	B	
June 5	22 35	40	1	48	{ B A	73 22.0 70 4.0	69 26.0 73 30.0	72 56.0 69 44.0	69 9.5 73 18.5	71 15.25 71 39.12	+23.87	71 27.19†	W	
June 9	3 40	52	1	56	{ A B	70 13.5 73 46.0	73 29.0 69 25.0	69 41.5 72 36.5	73 6.5 68 34.0	71 37.62 71 5.37	+32.25	71 21.50†	W	
June 9	23 30	60	1	...	{ B A	73 46.5 70 6.0	69 24.5 73 43.5	72 44.5 69 32.5	68 33.5 73 12.5	71 7.25 71 38.62	+31.37	71 22.94*	W	
June 12	22 50	...	1	...	{ A B	70 5.5 73 46.0	73 39.5 69 21.5	69 31.5 72 37.5	73 16.0 68 38.0	71 38.12 71 5.75	+32.37	71 21.94	W	
June 16	3 50	52	1	76	B	73 51.0	69 24.5	72 48.5	68 34.5	71 9.62	+28.38	71 23.81*	B	
June 19	22 35	18	1	63	A	70 8.5	73 18.0	69 44.5	73 21.0	71 38.00				
June 20	0 20	20	1	70	{ A B	70 4.5 73 55.0	73 34.0 69 20.0	69 39.5 72 39.5	73 13.5 68 39.5	71 37.87 71 8.50	+29.37	71 23.19*	B	
June 23	7 10	40	1	74	{ B A	73 55.0 70 12.5	69 20.0 73 32.0	72 39.5 69 37.0	68 39.5 73 14.5	71 8.50 71 39.00	+29.75	71 24.12	W	
June 26	22 55	50	1	58	{ A B	70 12.5 73 48.0	73 32.0 69 26.0†	69 37.0 72 43.5	73 14.5 68 39.5	71 39.00 71 9.25	+29.75	71 24.12	W	
June 30	4 0	...	1	64?	{ A B	70 8.5 74 38.0	73 32.0 68 29.5	69 40.0 73 20.0	73 18.5 67 56.0†	71 39.75 71 5.87	+33.88	71 22.81	W	
July 3	23 30	70	1	67	{ B A	74 50.0 70 4.5	68 31.0 73 36.0	73 43.5 69 31.0	67 32.0 73 19.0	71 9.12 71 37.62	+28.50	71 23.37†	B	
July 10	23 10	60	1	70	{ A B	70 2.5 74 6.0	73 42.0 69 8.5	69 35.0 72 54.5	73 23.5 68 36.5	71 40.75 71 11.37	+29.38	71 26.06	W	
July 14	3 45	52	1	74	{ B A	74 6.0 69 48.0	69 5.0 73 58.0	72 57.0 69 22.5	68 28.5 73 44.0	71 9.12 71 43.12	+34.00	71 26.12	W	
July 21	8 0	45	1	67	{ A B	69 46.0 73 43.5	74 7.5 69 23.0	69 19.0 72 59.0	74 27.5 68 41.0	71 55.00 71 11.62	+43.38	71 33.31†	B	
July 25	0 35	50	1	70?	{ B A	73 56.5 69 58.0	69 21.5 73 36.5	72 47.0 69 18.0	68 51.0 73 51.5	71 14.00 71 41.00	+27.00	71 27.50	W	
July 26	2 10	60	1	66	{ A B	69 54.5 74 0.0	73 51.0 69 32.0	69 11.5 72 46.0	73 53.0 68 51.0	71 42.50 71 17.25	+25.25	71 29.87†	B	
July 28	3 50	...	1	...	{ B A	73 49.5 69 40.0	69 32.5 74 6.0	72 46.5 68 59.5	68 51.0 74 4.5?	71 14.87 71 42.50	+27.63	71 28.69	W	
Aug. 1	4 0	180	1	62	{ A B	69 18.5 73 5.5	74 10.0 69 37.0	69 9.0 73 4.0	74 10.5 69 25.0	71 42.00 71 17.87	+24.13	71 29.94†	B	
Aug. 4	3 40	55	1	74	{ B A	73 11.5 68 58.5	69 27.0 74 12.0	72 34.0 68 55.0	69 22.5 74 13.0	71 8.75 71 34.62	+25.87	71 21.69*	W	
Aug. 7	23 0	60	1	65	{ A B	68 48.0 73 39.0	74 17.0 69 5.5	68 53.5 73 4.5	74 14.5 69 3.5	71 33.25 71 13.12	+20.13	71 23.19	W	

* Observations considered good.

† Observations considered bad or doubtful.

May 30^d. The Dip instrument was removed from the Magnetic Observatory to the wooden house erected for it and the extra declinometer. See *Introduction*.

June 5^d—Sept. 12. The Dip instrument during this period worked imperfectly, chiefly in lifting the needle. See *Introduction* for details.

Göttingen Mean Time, Middle of Observation.			Duration of Observation.	NEEDLE.			FACE OF CIRCLE E.		FACE OF CIRCLE W.		Mean.	A. dipping Minus B. dipping.	Observed Dip.	Observer's Initial.
				Num-ber.	Tem-perature.	End dipping.	Mark on Needle		Mark on Needle					
d.	h.	m.	m.				E.	W.	E.	W.				
Aug. 14	23	45	120	1	61	{ B	73 36.5	68 51.0	73 5.0	68 51.0	71 5.87	+ 35.00	71 23.37*	B
						{ A	69 42.5	73 30.0	69 56.0	73 35.0	71 40.87			
Aug. 18	8	5	40	1	73	{ A	69 41.0	73 35.0	69 41.0	73 30.0	71 36.75	+ 25.63	71 23.94*	B
						{ B	73 16.5	69 26.5	72 44.5	69 17.0	71 11.12			
Aug. 21	22	45	60	1	57	{ A	73 12.0	69 17.5	72 50.5	69 17.0	71 9.25	+ 23.50	71 21.00*	W
						{ B	68 45.0	74 13.5	68 59.5	74 13.0	71 32.75			
Aug. 25	3	40	...	1	79	{ A	68 36.0	74 10.0	68 56.5	74 22.5	71 31.25	+ 43.50	71 9.50†	W
						{ B	73 58.5	67 42.5	73 16.0	68 14.0	70 47.75			
Aug. 25	7	0	...	1	66	{ A	69 40.5	73 20.0	69 46.5	73 35.0	71 35.50	+ 45.88	71 12.56†	B
						{ B	69 44.5	73 27.5	69 41.0	73 33.5	71 36.62			
Aug. 28	22	40	55	1	66	{ A	73 21.0	69 40.0	72 58.0	69 11.5	71 17.62	+ 19.00	71 27.12†	B
						{ B	73 22.0	69 36.0	72 53.5	69 11.0	71 15.62			
Sept. 4	23	0	45	1	73	{ A	69 37.5	73 31.5	69 35.0	73 41.0	71 36.25	+ 20.63	71 25.94*	W
						{ B	69 33.0	73 31.0	69 34.5	73 44.5	71 35.75			
Sept. 8	8	0	45	1	77	{ A	74 3.5	68 32.5†	73 25.0	68 21.0	71 5.50	+ 30.25	71 20.62	W
						{ B	73 49.0	68 19.0†	74 3.5	68 44.0	71 13.87			
Sept. 12	1	5	110	1	75	{ A	69 49.5	73 15.5	69 51.5	73 6.0	71 30.62	+ 16.75	71 22.25†	B
						{ B	68 11.5	72 54.0	68 29.5	73 8.0	70 40.75			
Oct. 6	3	10	55	1	66	{ A	75 6.0	69 47.0	75 16.5	69 55.0	72 31.12	- 110.37	71 35.94†	W
						{ B	71 56.0	71 10.0	71 49.0	71 21.0	71 34.00			
Oct. 8	23	10	50	2	53	{ A	70 9.0	71 50.5	70 8.5	72 6.5	71 3.62	- 30.38	71 18.81†	W
						{ B	75 10.0	69 54.0	75 13.0	70 0.0	72 34.25			
Oct. 9	0	45	50	1	56	{ A	68 16.5	73 17.5†	68 17.5	73 27.5	70 49.75	- 104.50	71 42.00	B
						{ B	70 6.0	71 57.0	70 17.5	72 5.0	71 6.37			
Oct. 9	2	20	60	2	55	{ A	71 59.0	70 56.5	72 4.5	71 0.0	71 30.00	- 23.63	71 18.19	B
						{ B	68 22.5	73 5.5	68 8.0	73 8.0	70 41.00			
Nov. 20	1	30	...	1	40	{ A	74 29.0	69 47.0	74 35.0	69 51.5	72 10.62	- 89.62	71 25.81	W
						{ B	74 34.5	70 3.7	74 23.8	69 58.6	72 15.15			
Nov. 20	3	5	95	1	...	{ A	68 32.6	72 58.3	68 25.7	72 55.4	70 43.00	- 92.15	71 29.08	B
						{ B	71 55.1	71 16.2	71 55.4	71 13.0	71 34.92			
Nov. 21	1	35	50	2	...	{ A	70 49.5	71 59.2	70 39.0	71 46.3	71 18.50	- 16.42	71 26.71	W
						{ B	71 49.0	71 25.5	71 38.3	71 19.9	71 33.17			
Nov. 22	0	0	...	2	...	{ A	70 53.5	72 2.1	70 40.3	71 40.6	71 19.12	- 14.05	71 26.15	B
						{ B	70 50.0	72 1.5	70 37.5	71 38.5	71 16.87			
Nov. 24	3	10	55	2	42	{ A	71 34.0	71 22.5	71 44.5	71 17.0	71 29.50	- 12.63	71 23.19*	W
						{ B	71 51.0	71 15.6	71 42.9	71 12.9	71 30.60			
Nov. 28	0	0	100	2	50	{ A	71 5.2	71 42.0	70 55.3	71 35.3	71 19.45	- 11.15	71 25.02	B
						{ B	70 47.0	71 52.5	70 49.0	71 53.7	71 20.55			
Dec. 1	3	50	60	2	39	{ A	71 57.2	71 16.0	71 48.3	71 2.3	71 30.95	- 10.40	71 25.75	B
						{ B	71 52.0	71 16.0	71 47.5	71 2.5	71 29.50			
Dec. 4	23	15	70	2	48	{ A	70 30.5	72 27.0	70 6.0	71 51.5	71 13.75	- 15.75	71 21.62	W
						{ B	70 28.0	72 24.0	70 7.0	71 51.0	71 12.50			
Dec. 8	3	35	48	2	48	{ A	71 56.5	71 18.0	71 44.5	71 4.0	71 30.75	- 18.25	71 21.62	W
						{ B	71 58.0	71 20.5	71 50.0	71 8.0	71 34.12			
Dec. 12	1	0	...	2	49	{ A	71 5.5	71 59.5	70 45.5	71 36.0†	71 21.62	- 12.50	71 27.87	B
						{ B	71 5.5	71 59.0	70 51.0	71 40.0	71 23.87			
Dec. 15	3	40	...	2	50	{ A	72 5.0	71 22.0	71 53.0	71 11.0	71 37.75	- 13.88	71 30.81†	B
						{ B	72 6.0	71 20.0	71 45.5	70 59.5	71 32.75			
Dec. 18	23	15	60	2	42	{ A	70 47.0	72 14.0	70 26.0	71 43.0	71 17.50	- 15.25	71 25.12	W
						{ B	70 54.0	72 13.0	70 23.0	71 40.5	71 17.62			
Dec. 22	2	30	45	2	50	{ A	71 55.5	71 29.5	71 37.5	71 8.0	71 32.62	- 15.00	71 25.12	W
						{ B	72 5.0	71 30.5	71 43.0	71 4.0	71 35.62			
Dec. 27	0	15	60	2	48	{ A	71 6.0	71 59.0	70 39.0	71 27.0	71 17.75	- 17.87	71 26.69*	B
						{ B	71 8.0	72 3.7	70 42.9	71 26.7	71 20.32			
Dec. 29	3	55	70	2	47	{ A	72 7.0	71 28.0	71 44.0	71 4.0	71 35.75	- 15.43	71 28.03*	B
						{ B								

* Observations considered good.

† Observations considered bad or doubtful.

Aug. 18^d 8^h. A first attempt to change the poles of the needle failed, probably from the wrong end of the needle being taken.
 Sept. 12^d—Oct. 6^d. The dip instrument and needles sent to Messrs Adie and Son, Edinburgh, to be adjusted.
 Oct. 9^d—Nov. 20^d. The observations in October were so unsatisfactory that they were discontinued for some time.
 Nov 24^d 3^h. Before this observation the instrument was levelled, as it was previously slightly out of adjustment.

OBSERVATIONS

OF

ABSOLUTE HORIZONTAL INTENSITY.

MAKERSTOUN OBSERVATORY,

1843.

COMPARATIVE OBSERVATIONS FOR DEFLECTION.

Göttingen Mean Time of Observation.	DEFLECTING BAR.		DECLINOMETER.		Unifilar Reading.	Deflection.	Deflection corrected for Torsion.		Coefficient for Temp. at Deflection <i>Minas</i> Temp. at Vibration.	BIFILAR MAGNETOMETER.		Log. (Deflection) corrected, = tan. <i>u</i> .	Log. $\frac{1}{2}$ <i>r</i> ³ tan. <i>u</i> .	
	Distance = <i>r</i> .	N. Pole temperature.	Reading.	Reduced to Unifilar.			Sc. Div.	° ' "		° ' "	Reading Corrected.			Thermometer.
Aug. 21	d. h. m. 3 22 3 19 3 11 3 15 3 25 3 28 3 37 3 33 3 53 3 49 3 41 3 45	Feet. 8-500 9-000 9-500	E W E W E W E W E W E W E W E W E W E W E W E W	° 62-0 61-8 63-1 62-2 61-3 64-0 63-0 60-9 62-2 63-0 63-5	149-25	150-31	47-75	47-85	0 32 10-7	1-000342	523-4	61-8	7-9724802	0-4597069
					149-61	150-71					518-8	61-8		
					149-00	150-03					518-2	61-8		
					149-28	150-34					518-4	61-8		
					149-95	151-09					524-4	61-9		
					150-05	151-21					528-5	61-9		
					150-50	151-70					516-3	61-9		
					148-97	150-00					517-4	61-9		
					151-61	152-94					517-4	61-9		
					151-31	152-61					(Diff.)	61-9		
151-20	152-48	105-85												
150-92	152-17	107-58												
151-14	152-41	258-26												
151-99	153-36	260-94												
Aug. 20 23 7 Aug. 21 4 10	Magnet away			153-97	154-43	234-64	235-14	2 38 7-9	0-999459	506-0	42-6	8-6631877	0-4590677	
				153-69	154-11					506-5	42-6			
				152-76	153-08					509-7	42-6			
				153-60	154-01					506-2	42-6			
				153-60	154-01					506-5	43-0			
				154-96	155-53					504-8	42-9			
				156-04	156-74					508-9	42-8			
				153-29	153-67					503-3	42-9			
				155-00	155-57					506-9	43-0			
				155-37	155-99					504-1	42-9			
155-96	156-65	511-3	43-4											
153-53	153-93	513-8	43-5											
152-95	153-29	513-8	43-6											
153-05	153-40	513-1	43-6											
153-00	153-34	511-4	43-6											
152-26	152-32	513-6	43-6											
151-83	152-04	511-5	43-6											
153-43	153-82	512-1	43-6											
152-91	153-21	510-0	43-6											
153-34	153-73	508-3	43-6											
154-03	154-49	508-3	43-6											
154-08	154-46	509-1	43-6											
152-92	153-25	508-1	43-6											
152-56	152-86	508-3	43-6											
153-85	154-30	508-3	43-6											
154-08	154-55	507-3	43-6											
154-48	154-55	508-3	43-6											
152-48	152-77	508-3	43-6											
152-59	152-89	508-0	43-6											
151-99	152-22	509-9	43-6											
151-10	151-23	509-3	43-6											
155-16	155-75	(Diff.)												
154-00	154-46	107-09												
151-67	151-86	107-42												
Nov. 8	0 55 1 17 1 39 1 27 2 31 2 8 1 51 2 1 2 29 2 14 3 8 3 16 3 41 3 46 3 33 3 28 3 55 3 51 4 2 4 9 4 24 4 30 4 19 4 13 4 41 4 35 4 47 4 51	Magnet away			176-80	177-18	176-80	177-18	1 59 9-2	0-998917	506-9	43-0	8-5400332	0-4600913
					136-46	136-75					504-1	42-9		
					136-46	136-75					511-3	43-4		
					136-46	136-75					513-8	43-5		
					136-46	136-75					513-8	43-6		
					136-46	136-75					513-1	43-6		
					136-46	136-75					511-4	43-6		
					136-46	136-75					513-6	43-6		
					136-46	136-75					511-5	43-6		
					136-46	136-75					512-1	43-6		
136-46	136-75	510-0	43-6											
136-46	136-75	508-3	43-6											
136-46	136-75	508-3	43-6											
136-46	136-75	509-1	43-6											
136-46	136-75	508-1	43-6											
136-46	136-75	508-3	43-6											
136-46	136-75	507-3	43-6											
136-46	136-75	508-3	43-6											
136-46	136-75	508-0	43-6											
136-46	136-75	509-9	43-6											
136-46	136-75	509-9	43-6											
136-46	136-75	(Diff.)												
136-46	136-75	107-16												
136-46	136-75	(Diff.)												
136-46	136-75	107-09												
136-46	136-75	107-42												
136-46	136-75	107-25												
136-46	136-75	262-84												
136-46	136-75	261-88												
136-46	136-75	259-11												

Date.	N. POLE OF MAGNET MOVING E.					N. POLE OF MAGNET MOVING W.					BIFILAR MAGNETOMETER.				
	No. of Vibration.	Time of Transit.	No. of Vibration.	Time of Transit.	Time of one Vibration.	No. of Vibration.	Time of Transit.	No. of Vibration.	Time of Transit.	Time of one Vibration.	Time of Observation.	Reading Corrected.	Thermometer.	Mean Reading <i>Minus</i> 500 Sc. Div. in parts of force.	
	h. m. s.	h. m. s.	h. m. s.	h. m. s.	s.	m. s.	m. s.	m. s.	m. s.	s.	h. m.	Sc. Div.	°		
Aug. 12	0	3 15 17.4	50	3 28 14.3	15.538	0	15 31.7	50	28 28.1	15.528	3 38	509.9	69.6	+0.001386	
	10	17 53.0	60	30 49.6	532	10	18 7.1	60	31 3.3	524	3 48	513.2			
	20	20 28.3	70	33 24.8	530	20	20 42.4	70	33 38.35	519					
	30	23 3.7	80	36 0.0	526	30	23 17.7	80	36 13.4	514					
	40	25 39.0	90	38 35.0	520	40	25 52.9	90	38 48.7	516					
	50	28 14.3	100	41 10.2	518	50	28 28.1	100	41 23.4	506					
	60	30 49.6	110	43 45.2	512	60	31 3.3	110	43 58.5	504					
	70	33 24.8	120	46 20.3	510	70	33 38.35	120	46 33.4	501					
	80	36 0.0	130	48 55.2	504	80	36 13.4	130	49 8.5	502					
	Mean observed time of one vibration = 15s.5169. Mean semi-arc of vibration, 63°? Temperature of magnet, 69°6?														
Aug. 21	0	6 48 27.0	100	7 14 15.2	15.482	0	48 40.6	100	14 27.7	15.471	6 49	509.8	61.9	+0.001338	
	10	51 2.0	110	16 50.0	480	10	51 15.5	110	17 2.1	466	7 16	511.6	61.7		
	20	53 36.9	120	19 24.7	478	20	53 50.2	120	19 37.0	468	7 39	511.8	61.4		
	30	56 11.7	130	21 59.3	476	30	56 25.0	130	22 11.3	463					
	40	58 46.7	140	24 34.0	473	40	58 59.8	140	24 46.3	465					
	50	7 1 21.3	150	27 8.7	474	50	1 34.4	150	27 20.2	458					
	60	3 56.1	160	29 43.3	472	60	4 9.1	160	29 55.0	459					
	70	6 31.0	170	32 18.1	471	70	6 43.9	170	32 29.5	456					
	80	9 5.7	180	34 52.9	472	80	9 18.4	180	35 4.0	456					
	90	11 40.5	190	37 27.4	469	90	11 53.0	190	37 38.5	455					
Mean observed time of one vibration = 15s.4382. Semi-arc of vibration, commencing 9°, ending 3°. Temperature of magnet, 61°1.															
Nov. 8	0	5 35 34.0	100	6 1 21.7	15.477	0	35 50.7	100	1 39.0	15.483	5 37	508.9	43.1	+0.001313	
	10	38 9.2	110	3 56.0	468	10	38 25.7	110	4 13.7	480	5 43	509.1	43.0		
	20	40 44.1	120	6 30.5	464	20	41 0.9	120	6 48.2	473	5 53	510.9	43.0		
	30	43 19.0	130	9 5.0	460	30	43 35.8	130	9 22.8	470	6 3	512.0	42.9		
	40	45 53.8	140	11 39.5	457	40	46 10.7	140	11 57.4	467	6 26	513.6	42.9		
	50	48 28.6	150	14 13.8	452	50	48 45.6	150	14 31.9	463					
	60	51 3.4	160	16 48.1	447	60	51 20.4	160	17 6.3	459					
	70	53 37.9	170	19 22.5	446	70	53 55.0	170	19 40.9	459					
	80	56 12.7	180	21 56.8	441	80	56 29.8	180	22 15.3	455					
	90	58 47.1	190	24 31.2	441	90	59 4.5	190	24 49.8	453					
Mean observed time of one vibration = 15s.4307. Semi-arc of vibration, commencing 14°, ending 4°. Temperature of magnet, 43°3.															
Nov. 14	0	1 39 35.7	50	1 52 34.0	15.566	0	39 49.7	50	52 46.8	15.542	1 48	508.7	41.25	+0.001010	
	10	42 11.5	60	55 9.7	564	10	42 25.2	60	55 21.9	534	1 54	508.0	41.25		
	20	44 47.2	70	57 45.1	558	20	45 0.7	70	57 57.0	526	1 58	505.7	41.25		
	30	47 22.9	80	2 0 20.8	558	30	47 36.0	80	0 32.2	524	2 2	508.7	41.25		
	40	49 58.6	90	2 56.2	552	40	50 11.4	90	3 7.2	516					
	Mean observed time of one vibration = 15s.5440. Semi-arc of vibration, commencing 10°, ending 3½°. Temperature of magnet, 41°1.														
	0	2 8 6.0	50	2 21 3.6	15.552	0	8 19.3	50	21 15.9	15.532	2 9	506.5	41.25	+0.000975	
	10	10 41.7	60	23 39.0	546	10	10 54.8	60	23 51.2	528	2 14	508.4	41.25		
	20	13 17.1	70	26 14.5	548	20	13 30.0	70	26 26.6	532	2 19	507.5	41.25		
	30	15 52.6	80	28 50.0	548	30	16 5.3	80	29 1.8	530	2 25	508.0	41.25		
40	18 28.1	90	31 25.4	546	40	18 40.6	90	31 37.1	530	2 30	507.1	41.25			
Mean observed time of one vibration = 15s.5392. Semi-arc of vibration, commencing 7½°, ending 4½°. Temperature of magnet, 41°1.															

OBSERVATIONS FOR THE TIME OF VIBRATION.

Date.	N. POLE OF MAGNET MOVING E.				N. POLE OF MAGNET MOVING W.				BIFILAR MAGNETOMETER.			
	No. of Vibration.	Time of Transit.	No. of Vibration.	Time of Transit.	Time of one Vibration.	No. of Vibration.	Time of Transit.	Time of one Vibration.	Time of Observation.	Reading Corrected.	Thermometer.	Mean Reading <i>Miras</i> 500 Sc. Div. in parts of force.
Dec. 18	0	h. m. s. 3 29 44.6	50	h. m. s. 3 42 41.7	s. 15.512	0	m. s. 29 59.3	m. s. 42 56.0	h. m. s. 3 30	Sc. Div. 515.7	45.5	+ 0.001976
	10	32 20.2	60	45 17.0	536	10	32 34.8	45 31.2	3 36	515.5		
	20	34 55.6	70	47 52.2	532	20	35 10.1	48 6.4	3 44	514.8		
	30	37 31.0	80	50 27.5	530	30	37 45.5	50 41.5	3 49	514.7		
	40	40 6.3	90	53 2.8	530	40	40 20.8	53 16.7				

Mean observed time of one vibration = 15^s.5296. Seal-arc of vibration, commencing 10°, ending 4°. Temperature of magnet, 46°3.

The values of *m*, the magnetic moment of the deflecting and vibrating bar, and of *X*, the absolute horizontal intensity, are as under. For the complete discussion of these results, see *Introduction*.

Aug. 12. Temperature of the magnet = 69.6?; <i>m</i> = 9.8075.	Bifilar reading corrected, 500 Sc. div.; <i>X</i> = 3.3903.
Aug. 21. 61.1; <i>m</i> = 9.8322. <i>X</i> = 3.4024.
Nov. 8. 43.3; <i>m</i> = 9.8563. <i>X</i> = 3.3958.
Nov. 14. 41.1; <i>m</i> = 9.7501. <i>X</i> = 3.3993.
Dec. 18. 46.3; <i>m</i> = 9.7675. <i>X</i> = 3.3959.

It should be remarked that the observation of August 12th is imperfect, owing to the arc of vibration and the temperature of the magnet during vibration not having been observed; the quantities given being merely guessed, and probably not far from the truth.

DAILY METEOROLOGICAL
OBSERVATIONS.

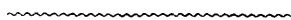

MAKERSTOUN OBSERVATORY,
1843.

Göttingen Mean Time of Observation.			BARO- METER. Corrected.	THERMOMETERS.				RAIN GAUGE.	ANEMOMETER.			Clouds moving from	Quan- tity of Clouds.
				Dry.	Wet.	Diff.	Max. and Min.		Pressure.		Direction of Wind.		
d.	h.	m.	in.	°	°	°	°	in.	lbs.	lbs.			0-10.
Jan.	1	20	0	29-883	31.0	28.4	2.6		1.2	0.0			7.5
		23	0	904	32.0	29.2	2.8		0.5	0.2	NW by N.	NNW.	5.0
Jan.	2	2	0	892	34.8	31.7	3.1	0.007	1.2	0.2	NNW.		2.0
		5	0	925	31.4	29.1	2.3		0.1	0.0		N by W.	2.0
		20	0	29-943	26.8	25.8	1.0		0.2	0.0			10.0
		23	0	929	31.7	30.4	1.3		0.0	0.0			10.0
Jan.	3	2	0	845	34.8	33.7	1.1	0.003	1.0	0.5	SSW.		10.0
		5	0	802	35.2	34.1	1.1				10.0
		20	0	29-385	41.0	38.2	2.8		3.0	1.5	W.		10.0
		23	0	476	37.2	34.1	3.1		...	1.5	W by S.		0.8
Jan.	4	2	0	506	39.9	35.8	4.1	0.117	3.0	0.5		W by N.	5.0
		5	0	475	36.5	34.2	2.3		1.8	0.8		W.	1.5
		20	0	29-442	35.6	33.1	2.5		3.0	0.2	W.		8.0
		23	0	580	34.0	31.2	2.8		1.2	1.0	NW by N.		0.2
Jan.	5	2	0	659	36.8	32.6	4.2	0.021	2.2	0.8	NW.		0.8
		5	0	738	35.8	32.3	3.5		2.0	1.5	NW.	NNW.	1.0
		20	0	29-834	34.7	32.8	1.9		1.2	0.0			10.0
		23	0	787	35.3	34.5	0.8		0.5	0.5	SW by W.		10.0
Jan.	6	2	0	652	40.1	39.2	0.9	0.025	1.5	0.8	SW by W.	SW.	10.0
		5	0	578	43.9	43.9	0.0		1.2	0.8	SW by W.	W by N.	9.5
		20	0	29-438	38.7	37.4	1.3		4.0	0.8	SW by S.	WSW.	8.5
		23	0	336	40.4	38.0	2.4		2.5	2.8	SW by W. v.	WSW.	4.0
Jan.	7	2	0	220	41.7	38.8	2.9	0.021	4.0	1.2	SSW.	W by S.	6.0
		5	0	174	36.1	35.3	0.8		5.8	0.5	SW by W.		10.0
Jan.	8	0	0		3.5				
		20	0	29-278	32.8	32.6?	0.2		0.2	0.2	W by S.		10.0
		22	0	29-229	31.3	29.3	2.0		0.5	0.2	SW by W.		10.0
Jan.	9	0	0	29-077	34.7	34.1	0.6		3.5	2.2	SW.		10.0
		2	0	28-960	38.1	36.3	1.8	0.650	3.5	1.0	SW.		10.0
		4	0	28-846	37.7	36.8	0.9		3.8	2.2	SW by S.	WSW.	9.5
		6	0	28-688	38.1	37.1	1.0		3.5	1.2	SW by S.		10.0
		8	0	28-576	40.2	38.8	1.4		3.5	1.5	SW by W.	W.	3.0
		10	0	28-559	39.9	37.0	2.9		2.8	2.5	SW by W.		0.2
		20	0	28-234	32.0	32.0	0.0		4.0	3.5	SW by W.		10.0
		22	0	276	37.0	34.1	2.9		5.0	4.8	NW by N. v.	W by N.	10.0
Jan.	10	0	0	415	37.0	33.1	3.9		5.8	4.1		W.	9.8
		2	0	476	34.8	31.0	3.8	0.092	6.0	2.8	NW by N. v.		1.5
		4	0	544	34.3	31.8	2.5		3.2	0.5	SW by W.		0.2
		6	0	544	33.2	32.2	1.0		1.5	2.0	W. v.		0.0
		8	0	563	32.9	29.7	3.2		2.8	2.0	W by S.		0.0
		10	0	541	33.0	31.2	1.8		2.0	2.2	W by S. v.		6.0
		20	0	28-647	35.2	32.2	3.0		5.5	0.8	SW by W. v.	WNW?	6.0
		22	0	687	32.6	30.2	2.4		0.5	0.5	W by S.	NW by N.	4.0
Jan.	11	0	5	681	34.7	32.3	2.4		1.0	0.2	W by S.		1.0
		2	0	651	35.4	33.2	2.2	0.000	1.0	0.5	W by S.	NW by N.	1.0
		4	0	641	34.7	32.4	2.3		0.5	0.0		W?	5.0
		6	0	628	31.0	30.8	0.2		0.2	0.0			5.0
		8	8	684	30.5		0.2	0.0			0.0
		10	0	591	29.4		0.0	0.0			0.0

Jan. 8^d 20^h. It is doubtful if the wet bulb was moist.

Jan. 9^d 1^h. By means of the rain gauge it was found that 6 inches of snow was equivalent to 0.65 inch of water.

Jan. 11^d 8^h. The wet bulb read higher than the dry bulb, although the former was moistened and the water frozen. In future, when the dry bulb reads below 32°, and the wet bulb reading is not given, it is from this cause.

SPECIES OF CLOUDS, &c.	Observer's Initial.
h.	
20. Linear cirri radiating from NW. to SE.; loose cumuli on E. horizon.	W
23. Woolly cirri pointing from SE. + curl cirri to SW. pointing from NE., cumuli and linear cirri to SE.	W
2. Linear cirri to W. pointing N. by W.; cum. on the horizon from NE. to SW by S.; some patches of scud	W
5. Patches of woolly cirri + loose cumuli nearly as before; linear cirri to W. pointing N. and S. [to E.	W
20. Cirrous clouds?	W
23. Id; linear cirri.	W
2. Semi-fluid-like mass of cirro-stratus.	W
5. Id.	W
20. Scud, &c.	W
23. A bank of cirro-stratus to E., loose cumuli on Cheviot.	W
2. Scud.	W
5. Id.	W
20. Scud, &c., linear cirri.	W
23. Cumuli to E., bank of cirro-stratus.	W
2. Cumuli and cirrous clouds to E. and NE., a few cirro-cumuli to S.	W
5. Loose cumuli and scud.	W
20. Cirrous clouds; red to E.; clouds breaking.	W
23. Homogeneous mass of cirro-stratus.	W
2. Scud + long cumuli on E. horizon; cirrous clouds above; breaking to S.	W
5. Id. + cirrous clouds, linear cirri to W.; misty rain lately.	W
20. Id. + id.; a few drops of rain.	W
23. Id.	W
2. Id. + loose cumuli on E. horizon, linear cirri to S.	W
5. Raining heavily. About 9 ^h snow began to fall, and on the morning of the 8th about 6 inches had fallen.	W
20. Cirro-stratus.	W
22. Cirro-cumuli and linear cirri.	W
0. Cirrous clouds?	W
2. Homogeneous cirro-stratus.	W
4. Scud + finely reticulated cirri, pointing from NNE. and SW.	W
6. Scud, &c.	W
8. Id.	W
10. A few patches of scud.	W
20. Snowing heavily—ceased in half-an-hour.	W
22. Light snow just begun. A little ago cirrous clouds seen above scud, which at 21 ^h moved from W. by N.,	B
but now the clouds are quite homogeneous. The greater part of the snow which fell on the 7th and 8th	W
0. Scud + cirro-strati above. [has disappeared this morning.	B
2. Cirrous clouds and a few cumuli to E.	W
4. Haze and a few cumuli on horizon.	W
6. Patches of cloud to S.	W
8. Quite clear.	W
10. Loose scud.	W
20. Cirrous scud and loose cumuli; clearing off; some snow still on the ground.	B
22. Scud + fine linear and mottled cirri.	W
0. Scud and cirrous clouds.	W
2. Fine woolly cirri in zenith + scud on S. horizon.	W
4. A few patches of scud + linear, mottled and flame-cirri; linear cirri pointing NNW. and SSE.; cirro-strati.	W
6. Sky nearly covered with cirrous haze. Lunar halo about 23° radius.	W
8. Nearly as before. Halo still seen.	W
10. Some cirrous haze? Halo more distinct and beautiful than ever.	B

The clouds placed first have their motions given, the motions of those following the mark + are unknown; when more motions than one are given, the clouds to which they belong are placed in the same order, beginning with the lowest, and are likewise separated by colons.

Göttingen Mean Time of Observation.			BARO- METER. Corrected.	THERMOMETERS.				RAIN GAUGE.	ANEMOMETER.			Clouds moving from	Quantity of Clouds.	
				Dry.	Wet.	Diff.	Max. and Min.		Pressure.		Direction of Wind.			
									Max.	Pres.				
Jan. 11	d. 11	h. 20	m. 0	in. 28.625	° 22.1	° 22.1	° 0.0	° 35.7	in. 0.0	lb. 0.0	lb. 0.0		0-10.	
				660	22.0	21.9	0.1	20.6		0.0	0.0	W ?	3.0	
Jan. 12	0	0	0	683	27.3	26.4	0.9		0.000	0.0	0.0		5.0	
				693	31.6	29.3	2.3			0.0	0.0		3.0	
				715	31.4	28.9	2.5			0.0	0.0		4.0	
				718	27.3	26.2	1.1			0.0	0.0		8.0	
				720	25.6	24.4	1.2			0.0	0.0		1.0	
				695	24.1	23.5	0.6			0.0	0.0		0.0	
				28.029	33.9	33.8	0.1			?	3.0	SE.	10.0	
				27.909	34.3	33.3	1.0	31.6		3.5	3.0	SE by S.	10.0	
Jan. 13	0	0	0	27.864	35.6	34.7	0.9	20.5	0.200	3.2	0.5	SE.	SSE ?	9.8
				27.837	37.6	35.3	2.3			0.0	0.0		10.0	
				27.850	35.6	34.7	0.9			0.0	0.0		10.0	
				27.874	34.2	33.7	0.5			0.0	0.0	WNW ?	10.0	
				27.910	34.2	33.5	0.7			0.0	0.0	WNW.	10.0	
				27.955	35.3	34.0	1.3			0.2	0.0	NW ?	10.0	
				28.364	35.5	32.0	3.5	37.9		7.5	6.0	NW by W. v.	W.	10.0
				403	34.2	32.3	1.9	33.8		4.5	2.5	WNW. v.		3.0
Jan. 14	0	0	0	454	34.2	31.1	3.1		0.000	3.8	1.5	NW by W. v.	W by N.	7.0
				477	35.0	32.1	2.9			2.2	0.8	W by S.	W by S.	4.0
				470	30.8	30.6 ?	0.2 ?			1.2	0.2	W by S.		4.0
				465	30.3	30.2 ?	0.1 ?			0.5	0.2	W by S.		7.0
				507	27.3	24.7	2.6			0.5	0.0			2.5
				28.525	26.6	24.0	2.6			0.5	0.2	WSW.		1.0
Jan. 15	0	0	0	35.8		0.5				
				29.097	39.3	35.6	3.7	19.9		2.0	1.0	N by W.		10.0
				216	37.8	36.3	1.5		1.5	0.8	N by W.		9.8
				329	38.8	36.8	2.0		1.8	1.0	N by W.	N by E.	7.0
Jan. 16	0	0	0	429	38.3	36.0	2.3		0.165	1.5	0.5	NW by N.	N by W.	7.0
				516	39.9	36.8	3.1			1.5	0.8	NNW.		2.0
				608	38.9	36.1	2.8			1.5	0.5	NW.	N.	2.0
				688	37.9	35.4	2.5			1.8	0.0		N.	5.0
				756	35.3	33.7	1.6			0.2	0.2	NW by N.		3.0
				800	32.3	31.2	1.1			0.2	0.0			0.1
				29.810	35.0	33.2	1.8			0.5	0.5	SW.		10.0
				772	36.3	34.9	1.4	39.3		1.0	0.5	SW by S.		10.0
				750	38.5	37.1	1.4	29.3		2.5	2.0	SW.	SW by W.	10.0
Jan. 17	0	0	0	739	39.8	38.5	1.3		0.028	3.0	1.8	SW by W.	SW by W.	10.0
				725	41.3	40.1	1.2			2.5	2.0	WSW ?	WSW : WNW.	9.9
				752	40.3	39.6	0.7			0.8	0.2	SW by W.	W : NW.	9.0
				764	43.0	41.8	1.2			0.2	0.0		W by S.	7.0
				777	42.9	41.3	1.6			2.5	0.2	SW by S ?		6.0
				812	44.2	42.8	1.4			1.0	1.0	SW by S. v.	W.	9.8
				29.915	44.3	43.8	0.5			1.5	0.8	SW by W.	WSW ?	10.0
				922	43.7	42.9	0.8			1.5	0.5	SW by W.	WSW : W ?	8.0
				938	44.5	42.9	1.6	45.2		2.0	1.8	SW by W.	SW : W.	7.0
Jan. 18	0	0	0	960	46.3	43.9	2.4	39.8 ?	0.000	1.8	1.5	SW.	WSW.	9.9
				983	46.2	44.7	1.5			3.0	1.2	SW by S.	W.	9.0

Jan. 11^d 20^h 15^m. The difference of the dry and wet bulbs = 0°.4.

Jan. 15^d 18^h. The maximum temperature of yesterday was attained this morning, the maximum was therefore lost, and there was no minimum, as the temperature rose during the night; at 15^d 6^h the temperature was 27°.4.

Jan. 17^d 18^h. The index of the minimum thermometer was at 36°.4, which was probably the temperature at setting yesterday morning; the minimum given is from the dry bulb reading at 17^d 4^h, as the temperature was probably not below 43° during the night.

SPECIES OF CLOUDS, &c.

Observer's
Initial.

- h.
20. Linear cirri pointing NNE. and SSW., cirrous haze. W
22. Patches of mottled cirri + cirri as before, but so thick to S. that the sun's rays project but a faint shadow, a line of small cumulo-stratus to N. W
0. Thick cirrous clouds to SE., fine curl, woolly, and linear cirri, the latter pointing N. and S. ? W
2. Flame, woolly and reticulated cirri, the latter pointing N. by E. and S. by W., cirrous clouds and cumuli W
4. Woolly cirri; cirro-strati and cumuli on NE. horizon. [on horizon. W
6. A few linear cirri to E. pointing N. and S. W
8. Quite clear. W
10. Id. W
20. Snowing. The wind has been very high during the night, but the vane of the Anemometer has been frozen up; the present force might be esti- B
22. Sleet. [mated at about 5 lbs. W
0. Scud + thick cirrous clouds, very hazy to E.; sky in patches to SW. W
2. Homogeneous, except a few cumuli to S. W
4. Beginning to snow. W
6. Scud. W
8. Id. W
10. Id.; occasional patches of sky. W
20. Scud + cirrous clouds to E. W
22. Woolly and contorted cirri; snowing to N. and E. ? surface of the ground freezing. B
0. Woolly cirri + fine linear cirri pointing WNW., cumulo-cirrous clouds. W
2. Id. + id. id. W
4. Id.; loose cumuli on NE. horizon, cirrous scud to S.; sky red to N. and NE. W
6. Id.; linear cirri to W. lying N. and S., haze to S. W
8. Thin woolly cirri. W
10. Thin cirrous clouds on horizon; beautifully clear evening. W
18. Dark woolly-like clouds. B
20. Raining since 18^h 30^m scud; sky to NE. and SE. B
22. Scud + cirrous clouds and loose cumuli to S. and on NE. horizon. W
0. Thin scud + woolly-edged cumuli. W
2. Loose cumuli on N. horizon, woolly cirri and woolly-edged cumuli to S. W
4. Patches of scud + loose cumuli to N., cumulo-strati to S. W
6. Scud, clearing off rapidly. W
8. Woolly cirri, a range of cumulo-strati to SE. W
10. A small patch of woolly cirrus to SE. W
18. Clouds homogeneous. W
20. Id. W
22. Scud, moving rapidly; light rain. B
0. Id. [of rain. B
2. Loose strings of scud, very low and moving rapidly: thick scud, slowly + cirrous clouds; occasional drops B
4. Thin scud: thick scud + cirrous clouds; large banks of white clouds to SE.; clouds blue to E. W
6. Scud + cumulo-strati to S. W
8. Scud and cirrous clouds. B
10. Scud. Wind in gusts. B
18. Scud. B
20. Cirri chiefly linear. A coloured lunar corona, the innermost colour is a bluish-white of about 2 diameters in breadth, next yellow of $\frac{3}{4}$ diameter, next a brownish or reddish colour of $\frac{3}{4}$ diameter, next light-blue $1\frac{1}{2}$ diameter; the corona becomes elliptical, the major axis lying in the direction of the linear cirri which are probably a principal cause of it; red is afterwards seen to the outside of the blue and the inner red becomes yellowish or orange: the appearance of the clouds is very strange, the mass of clouds from the zenith to the SE. is a kind of cirro-cumuli, all which, in a radius of 30° from the SE. is intensely red; the clouds over the whole sky are more or less tinged with red. B
22. Scud: cirro-cumuli and woolly cirri + linear cirri to E. pointing N. by W., masses of loose cumuli on E. horizon, cumulo-strati to N. W
0. Cirrous scud, mottled, linear, speckled, and contorted cirri, large woolly cirro-cumuli, the clouds have a strange appearance, the scud seems spreading out into a sort of cirro-cumuli and mottled cirro-strati. W
2. Scud + woolly, mottled, and striated cirri lying E. to W., loose cumuli on E. horizon, cumuli-strati to N. W

Göttingen Mean Time of Observation.			BARO- METER Corrected.	THERMOMETERS.				RAIN GAUGE.	ANEMOMETER.			Clouds moving from	Quantity of Clouds.
				Dry.	Wet.	Diff.	Max. and Min.		Pressure.		Direction of Wind.		
d.	h.	m.	in.	°	°	°	°	in.	lbs.	lbs.			0-10.
Jan. 18	4	0	30.002	47.1	45.5	1.6			2.0	0.8	SW.	W by S.	9.0
	6	0	044	46.9	45.3	1.6			1.8	1.0	SW.		10.0
	8	0	089	46.3	45.4	0.9			1.2	0.5	SW.		10.0
	10	0	122	46.2	45.4	0.8			0.5	0.0			10.0
	18	0	30.139	46.2	45.2	1.0			1.8	1.0	WSW.		WSW.
Jan. 19	20	0	174	45.6	44.2	1.4			1.8	0.5	WSW.		10.0
	22	0	189	45.8	44.8	1.0	46.7		0.5	0.5	SW by W.		10.0
	0	0	196	46.8	45.7	1.1	41.4	0.006	0.5	0.8	SW by W.	WSW ?	10.0
	2	0	176	47.0	45.5	1.5			1.0	0.0			10.0
	4	0	172	46.5	45.2	1.3			1.0	0.0			10.0
	6	0	181	45.3	44.4	0.9			0.5	0.2	SW.		10.0
	8	0	184	44.7	43.7	1.0			0.5	0.0			10.0
	10	0	176	43.5	42.5	1.0			1.0	1.0	SW by S.		9.0
	18	0	30.089	43.0	42.1	0.9			1.2	0.0		WSW.	10.0
	20	0	30.064	40.7	39.9	0.8	47.3		0.0	0.0		SW by W ?	8.0
Jan. 20	22	0	30.061	41.8	40.9	0.9	42.0		0.2	0.0		SW.	9.5
	0	0	30.022	44.3	42.6	1.7		0.000	0.2	0.0		S by W.	8.0
	2	0	29.995	43.2	41.6	1.6			0.2	0.2	SW by S.	S by W.	10.0
	4	0	29.969	41.8	39.7	2.1			0.5	0.0		SSW.	10.0
	6	0	29.951	40.0	38.0	2.0			0.2	0.0		S by W ?	7.0
	8	0	29.930	34.7	33.8	0.9			0.2	0.0			0.0
	10	0	29.909	33.0	32.3	0.7			0.0	0.0			0.0
	18	0	29.791	29.5	28.3	1.2			0.0	0.0			1.0
	20	0	763	28.0	44.4		0.0	0.0			1.0
	22	0	748	27.7	26.8		0.0	0.0			5.0
Jan. 21	0	8	709	30.2	29.7	0.5		0.000	0.0	0.0			0.0
	2	0	682	33.7	31.8	1.9			0.0	0.0			0.0
	4	0	662	35.8	33.0	2.8			0.8	0.2	SW by W.	SW.	9.0
	6	0	678	34.8	33.0	1.8			0.2	0.0		SW ?	10.0
	8	0	676	35.2	33.0	2.2			0.2	0.0			10.0
	10	0	674	36.2	34.3	1.9			0.0	0.0			10.0
Jan. 22	0	0	43.5		0.5	...			
	18	0	29.654	37.1	36.8	0.3	25.4		1.5	0.0			0.0
Jan. 23	20	0	635	38.0	36.9	1.1	46.1		1.2	1.2	S by E.		2.0
	22	0	628	38.9	37.5	1.4	36.0		1.2	0.5	S by E.	SW ? : NW ?	9.0
	0	0	593	42.2	40.3	1.9		0.000	1.2	0.8	S by E.		9.5
	2	0	534	43.7	41.5	2.2			1.2	...		S by W.	8.0
	4	0	489	44.1	41.6	2.5			1.2	1.0	S by E.	S by W : S.	9.5
	6	0
	8	0	409	43.7	42.0	1.7			3.0	0.5	S by E.		10.0
	10	0	362	44.0	42.8	1.2			2.8	1.5	S by E. v.		10.0
	18	0	29.306	46.8	44.9	1.9			3.5	1.2	SSW.		8.0
	20	0	325	46.9	45.3	1.6	44.0		2.0	1.5	SW by S.	SW.	9.8
Jan. 24	22	0	348	45.2	43.8	1.4	42.9		1.2	0.8	SW by S. v.	WSW ?	3.0
	0	0	369	46.9	45.3	1.6		0.181	2.0	2.5	SW by S.	WSW ?	4.0
	2	0	364	47.8	45.9	1.9			2.5	0.8	SW by S.	SW : SW.	8.0
	4	0	371	47.6	45.2	2.4			1.5	0.8	SW by S.	SW by S.	10.0
	6	0	379	46.4	44.0	2.4			1.0	0.8	SW by S.	SW.	9.0
	8	0	400	44.7	42.6	2.1			1.5	1.2	SW by S.		1.5
	10	0	424	44.3	42.1	2.2			1.0	0.8	SW by S.		1.0
	18	0	29.446	44.0	42.0	2.0			2.5	2.2	SW by S.		8.0

Jan. 24^d 0^h. The dry and wet bulbs, the maximum and minimum, and the standard thermometers, were placed to-day on the new revolving frame. (See Introduction.)

SPECIES OF CLOUDS, &c.

Observer's
Initial.

h.		
4.	Masses of cirro-cumuli and mottled cirro-strati + varieties of cirri; sky of a deep blue, the clouds have a bluish or greyish tinge.	B
6.	Clouds quite homogeneous.	B
8.	Dark; light rain.	W
10.	Light rain.	W
18.	Scud, moving rapidly.	D
20.	Id.; light rain.	D
22.	Id., cumulo-strati on NE. horizon.	W
0.	Id., nearly homogeneous.	B
2.	Id.	H
4.	Id.	B
6.	Id., light rain.	H
8.	Clouds homogeneous, dark.	W
10.	Cirrous haze, stars seen dimly; the moon rising red.	B
18.	Scud, like a thin stratum of a semifluid pouring over the moon's face.	B
20.	Scud + the sky nearly covered with cirrous clouds and haze.	B
22.	Id. + fine woolly and silky cirri.	W
0.	Id. + woolly cirri, loose cumuli on horizon from N. to E.	W
2.	Id.	W
4.	Id. + cirrous clouds to S.	W
6.	Id. + id. ; the scud covers all the sky except three-tenths to E.	B
8.	Stars seen indistinctly.	W
10.	Id.	W
18.	Light cirri; lunar halo at 17 ^h 50 ^m .	W
20.	Id.; haze to E. and N., tinged with red to E.	W
22.	Linear and mottled cirri lying in strata from E. to W., becoming thick haze on all sides except to W.; fog, objects invisible at $\frac{3}{4}$ of a mile to	[S. and E.; hoar frost.
0.	Hazy as before to E., fog clearing off.	B
2.	Hazy round horizon.	B
4.	Scud.	W
6.	Id.	W
8.	Id.	B
10.	Id.	B
18.	Quite clear.	W
20.	Linear cirri lying NW. to SE., loose cumuli on Cheviot.	W
22.	Patches of scud on hor.: woolly cirri lying in strata from NW. to SE.	B
0.	Nearly as at 22 ^h , clouds thicker.	B
2.	Cirrous-edged cumuli.	B
4.	Scud: mottled and woolly cirri moving very slowly.	W
6.		W
8.	Raining heavily.	W
10.	Id.	W
18.	Scud; rain; a flash of lightning seen; clouds moving off.	B
20.	Id.; smart showers.	B
22.	Id. + woolly cirri to E., loose cumuli to SW.	W
0.	Id. + woolly and mottled cirri.	W
2.	Id., moving quickly: cirrous clouds, slowly + fine cirro-cumuli to E.	W
4.	Id.	B
6.	Id.; smart shower commenced.	B
8.	Scud to N.	W
10.	Scud.	W
18.	Scud; cirrous clouds above?	W

Göttingen Mean Time of Observation.			BARO- METER Corrected.	THERMOMETERS.				RAIN GAUGE.	ANEMOMETER.			Clouds moving from	Quan- tity of Clouds.
				Dry.	Wet.	Diff.	Max. and Min.		Pressure.		Direction of Wind.		
									Max.	Pres.			
Jan. 24	d. 20	m. 0	29.477	° 44.1	° 42.5	° 1.6	° 47.2	in.	lbs. 2.5	lbs. 1.0	SW.	WSW.	0-10.
		22 0	530	45.0	43.0	2.0	43.3		1.8	1.5	SW.	W by S.	10.0
Jan. 25	0 0	0 0	567	46.9	43.4	3.5		0.006	1.8	2.0	SW.	W by S.	8.5
		2 0	569	47.5	43.5	4.0			3.2	1.8	SW by W. v.	W.	9.5
		4 0	580	46.1	44.0	2.1			2.0	0.8	SW by W ?	WNW.	10.0
		6 0	628	45.8	44.0	1.8			0.8	0.2	SW by W.	W by S ?	8.0
		8 0	620	46.8	45.1	1.7			1.0	0.8	SW by W.		10.0
		10 0	587	47.2	45.8	1.4			2.0	1.5	SW by S.		10.0
		18 0	29.527	46.9	45.3	1.6			2.5	0.5	WSW. v.	WNW.	1.5
		20 0	579	46.0	43.9	2.1	47.4		0.8	0.2	SW ?	WNW.	1.0
		22 0	655	46.3	44.3	2.0	43.2		0.8	0.5	W ?	WNW : WNW.	5.0
Jan. 26	0 0	0 0	668	46.9	42.9	4.0		0.060	1.0	0.8	W by S.		10.0
		2 0	669	46.8	41.9	4.9			0.8	0.5	SW by W.	W by N.	5.0
		4 0	673	45.3	41.8	3.5			1.2	1.5	SW by W.	WNW.	10.0
		6 0	680	44.5	41.4	3.1			1.0	1.0	SW by W. v.	WNW.	10.0
		8 0	644	43.2	41.3	1.9			1.8	0.8	SW by W.		10.0
		10 0	589	45.0	42.9	2.1			2.2	1.8	SW.		10.0
		18 0	29.425	50.0	48.7	1.3			6.0	2.2	SSW.		10.0
		20 0	418	50.0	48.2	1.8	47.4		2.0	1.2	SW by S.	WSW.	7.0
		22 0	382	49.5	47.7	1.8	42.9		3.8	2.8	SW.	SW by W : W.	10.0
Jan. 27	0 0	0 0	363	49.9	48.1	1.8		0.000	4.8	4.0	SW.	WSW.	10.0
		2 0	319	49.2	48.0	1.2			5.2	4.5	SW.	WSW.	10.0
		4 0	330	51.8	50.3	1.5			4.0	0.8	SW.	W by S.	9.9
		6 0	333	55.2	51.8	3.4			2.2	1.8	SW.	WSW.	9.9
		8 0	293	54.9	51.6	3.3			3.5	2.5	SW.		9.0
		10 0	292	53.9	50.9	3.0			2.5	2.8	SW.		8.0
		18 0	29.154	48.8	43.0	5.8			9.0	7.0	WNW. v.	W.	0.5
		20 0	167	47.3	42.7	4.6	55.1		5.0	3.5	Varying.	W. by N.	1.5
		22 0	202	48.1	43.0	5.1	46.8		5.0	3.0	WSW. v.	W.	10.0
Jan. 28	0 0	0 0	227	47.8	43.7	4.1		0.014	3.0	3.5	SW by W. v.	W by S.	10.0
		2 0	185	47.5	45.4	2.1			5.0	3.8	SW by W. v.	W by S.	9.5
		4 0	193	46.5	42.8	3.7			6.2	6.0	WNW. v.	WNW.	3.0
		6 0	293	44.9	40.9	4.0			8.0	2.8	WNW.	WNW.	0.5
		8 0	381	43.2	38.0	5.2			5.0	3.2	NW by W. v.		0.0
		10 0	439	42.9	38.0	4.9			6.0	5.2	NW by W.		0.0
Jan. 29	0 0	0 0	48.3		4.8				
		18 0	29.121	47.6	43.1	4.5	41.9		5.0	3.0	SW by W.	WNW.	1.0
		20 0	104	46.3	42.0	4.3			4.8	3.5	SW by W. v.	W.	4.0
		22 0	109	44.8	40.2	4.6	54.1		7.2	8.2	W by N. v.	W. by N.	2.0
Jan. 30	0 0	0 0	110	47.8	41.6	6.2	46.4		9.5	8.2	W. v.	W. by N.	6.0
		2 0	176	46.0	41.2	4.8		0.270	9.5	6.5	W. v.	WNW.	2.0
		4 0	240	44.3	39.8	4.5			6.2	7.0	W. v.	W. by N.	1.0
		6 0	265	43.8	39.9	3.9			6.8	8.0	NW.	WNW.	0.5
		8 0	317	43.8	39.4	4.4			9.8	6.0	NW.		0.0
		10 0	465	43.7	39.1	4.6			5.5	1.8	W by S.		0.0
		18 0	29.499	42.0	40.4	1.6			2.5	1.2	SW.		4.0
		20 0	469	44.0	41.1	2.9	47.6		1.5	0.8	SW by W.	W by S ?	9.9
		22 0	433	45.2	43.0	2.2	41.3		2.5	0.8	SW by W.	SW by W.	9.9

Göttingen Mean Time of Observation.			BARO- METER Corrected.	THERMOMETERS.				RAIN GAUGE.	ANEMOMETER.			Clouds moving from	Quantity of Clouds.
				Dry.	Wet.	Diff.	Max. and Min.		Pressure.		Direction of Wind.		
									Max.	Pres.			
Jan. 31	d. h. m.	in.	°	°	°	°	in.	lbs.	lbs.			0-10.	
	0 0	29.366	47.8	45.3	2.5		0.020	3.8	2.5	SW by W.		10.0	
	2 0	279	49.0	47.3	1.7			2.8	2.0	SW by S.		9.8	
	4 0	225	50.2	47.7	2.5			4.2	2.5	SW.	SW.	10.0	
	6 0	106	49.3	47.7	1.6			5.0	5.0	SW.	SW.	10.0	
	8 0	102	50.8	48.2	2.6			7.2	4.0	SW.	SW ?	3.0	
	10 0	172	46.8	42.8	4.0			4.8	1.8	SW by S.		2.0	
	18 0	29.325	38.0	36.2	1.8			5.0	1.2	SW by S.		0.0	
	20 0	320	40.6	38.2	2.4			2.0	1.5	SW.	SW.	1.5	
	22 0	381	40.3	37.7	2.6	51.8		3.0	1.5	SW.	W ? : WSW.	3.0	
Feb. 1	0 0	380	42.5	39.1	3.4	37.5		3.0	2.8	SW.	WSW.	1.5	
	2 0	315	44.9	40.2	4.7		0.092	4.2	3.2	SW.	SW by S.	3.5	
	4 0	231	45.0	40.8	4.2			5.2	4.2	SW by S. v.	SW.	9.5	
	6 0	171	42.0	41.3	0.7			6.8	4.0	SW by W.		10.0	
	8 0	164	40.0	38.8	1.2			4.5	1.8	SW.		9.0	
	10 0	143	42.4	39.8	2.6			5.2	2.5	SW.		4.0	
	18 0	29.026	39.9	36.7	3.2			6.2	3.0	SW.		4.0	
	20 0	026	38.1	34.8	3.3			4.5	1.8	SW.	SW by W.	6.0	
	22 0	061	36.8	33.1	3.7	44.8		4.0	1.2	SW. v.	W by S.	6.0	
Feb. 2	0 0	115	37.4	33.3	4.1	38.5		4.5	4.8	W by N. v.		9.0	
	2 0	149	33.7	32.2	1.5		0.345	3.8	4.0	SW by W.		8.0	
	4 0	147	35.7	32.3	3.4			2.5	1.2	SW.	W by S : W.	8.5	
	6 0	138	33.6	31.9	1.7			2.8	1.5	SW by W.	W by S.	7.0	
	8 0	106	35.4	32.8	2.6			2.5	2.5	SW.	W.	1.0	
	10 0	088	33.2	33.2	0.0			3.5	2.0	SW.		10.0 ?	
	18 0	28.881	32.9	32.2	0.7			5.2	1.2	SW.		1.0	
	20 0	28.810	34.0	33.5	0.5			2.5	1.0	SW by W. v.	W.	10.0	
	22 0	28.805	32.0	31.3	0.7	39.6		3.0	0.5	SW by W.	W ?	3.0	
Feb. 3	0 0	28.785	33.6	30.7	2.9	30.2		1.2	0.7	WNW. v.	W.	2.0	
	2 0	28.770	32.7	30.4	2.3		0.387	2.5	1.5	NW by W.	NW.	3.0	
	4 0	28.834	30.9	29.9 ?	1.0 ?			3.0	2.8	N by W.	NW.	7.0	
	6 0	28.952	26.7	26.1	0.6			5.5	3.2	N.		10.0	
	8 0	29.022	23.0	22.2	0.8			4.2	1.2	N by W.		0.0	
	10 0	29.068	23.5	22.9	0.6			4.0	4.8	NNW. v.		10.0	
	18 0	29.162	34.6	32.9	1.7			8.0	6.8	NW by N.		10.0	
	20 0	232	36.4	33.8	2.6			9.2	8.0	N by W.	N.	9.8	
	22 0	420	37.4	34.0	3.4	34.5		12.8	4.5	N by W.	N by E.	9.0	
Feb. 4	0 0	532	37.7	34.3	3.4	21.3		5.2	5.0	N by W.	N by E.	7.0	
	2 0	573	36.5	34.0	2.5		0.166	5.5	7.0	N by W.		3.5	
	4 0	619	36.0	32.4	3.6			5.5	6.0	N by W.	N.	7.0	
	6 0	682	33.6	30.9	2.7			7.0	2.0	NNW.	N by E.	7.0	
	8 0	718	33.8	31.6	2.2			2.2	1.2	NNW.	N. by E.	6.0	
	10 0	728	32.0	31.0	1.0			1.5	0.2	NW by N ?		3.0	
Feb. 5	0 0	38.6		1.8					
	18 0	29.827	30.7	29.1	1.6	30.5		1.5	1.0	NNW.		0.5	
	20 0	844	29.7	28.1	1.6			1.2	0.8	NNW.		2.0	
	22 0	862	29.8	28.0	1.8	33.7		0.8	0.5	NNW.	NNE.	8.0	
Feb. 6	0 0	867	34.3	32.8	1.5	29.1		1.5	1.2	NNW.	NNE.	9.8	
	2 0	842	36.1	32.8	3.3		0.000	1.5	1.2	N by W.	NNE.	9.5	
	4 0	860	35.9	33.1	2.8			2.0	1.0	N.	NNE.	9.9	
	6 0	860	36.5	34.5	2.0			2.5	1.2	N by W.	N by E.	10.0	
	8 0	882	35.3	34.9	0.4			2.0	0.8	N by E.	NNE.	9.8	
	10 0	890	36.3	35.0	1.3			0.2	0.2	NNE.	NNE.	0.5	

SPECIES OF CLOUDS, &c.	Observer's Initial.
h.	
0. Scud creeping along horizon, cirro-cumuli, cirrous haze, bluish-black cirro-stratus to E.; rain apparently falling to S. and W., very stormy like.	B
2. Scud + very fine mottled cirri; sky to E.	B
4. Id.; some of the clouds have a blue tint.	W
6. Id. very thick.	W
8. Id.	B
10. Long strips of clouds pointing from SW. to NE. extending through 120°; a flash of lightning.	B
18. Clear.	B
20. A great mass of cumuli or nimbi on horizon to S. and SE.; a few drops of rain; a flash of lightning about [19h.	B
22. Patches of scud to N.: mottled cirri, striated at the edges, the striæ pointing NNW + cirrous haze and cumuli on S. horizon.	W
0. Patches of scud + loose cumuli on S. horizon; a number of sea gulls seen flying from eastward.	W
2. Scud + woolly cirri.	W
4. Id.; sky on E. horizon.	B
6. Heavy rain.	B
8. Scud; like haze in some places.	W
10. Loose scud, light rain.	W
18. Scud.	W
20. Id. + woolly and linear cirri, cirro-cumuli.	W
22. Cirrous scud + a large mass of cirro-stratus on E. and S. horizon; a slight fall of snow.	B
0. A smart shower of snow.	B
2. Id., scud.	B
4. Scud: woolly cirri + cumuli and nimbi falling in snow to S. and E.	W
6. Id. + cumuli round horizon.	W
8. Id.	B
10. Snowing; lightning seen before and after this.	B
18. Clouds to NW. and SE.	B
20. Scud.	B
22. Cirrous scud + woolly cirri, large masses of cumulo-strati on NE. horizon.	W
0. Woolly cirri + cumulo-strati on NE. horizon.	W
2. Id. + id., loose cumuli to S.	W
4. Woolly cirro-strati, falling in snow on all sides but the S.; quite overcast, with snow in a few minutes.	B
6. Cumuli to NW.	B
8. Clear.	W
10. Overcast.	W
18. Homogeneous, a slight fall of snow.	W
20. Scud; a few drops of rain.	W
22. Loose vapoury clouds falling in powdery hail; beautiful cumuli to SE.	B
0. Cirrous scud + loose cumuli to S.	B
2. As before.	B
4. Cirrous scud.	W
6. Id.	W
8. Id.	B
10. Id.	B
18. A bank of clouds to E.	W
20. Woolly cirri and cirrous scud to E.	W
22. Large woolly cirro-cumuli + linear cirri to SW.	B
0. Id.	B
2. Id.	B
4. Cirrous scud + a homogeneous mass to S.; a slight shower of snow.	W
6. Id. + cirrous clouds.	W
8. Scud; light rain; coloured lunar corona.	B
10. Loose cumuli.	B

Göttingen Mean Time of Observation.			BARO- METER Corrected.	THERMOMETERS.				RAIN GAUGE.	ANEMOMETER.			Clouds moving from	Quantity of Clouds.
				Dry.	Wet.	Diff.	Max. and Min.		Pressure.		Direction of Wind.		
									Max.	Pres.			
Feb. 6	d. 19	m. 0	in. 29.990	° 39.3	° 38.1	° 1.2	°	in.	lbs. 2.0	lbs. 0.8	NE by N.		0-10.
			30.020	39.8	38.8	1.0			1.0	0.2	NE by N.	NE : ENE.	9.8
			30.042	40.2	39.3	0.9	37.0		0.5	0.5	NNE.	ENE.	9.5
Feb. 7	0	0	30.058	41.1	39.2	1.9	34.8 ?		0.5	0.5	NE by N.	NE by E.	10.0
			30.063	41.2	39.9	1.3		0.016	0.5	0.2	N by E.	NE.	10.0
			30.044	40.8	40.2	0.6			0.5	0.2	NNE.		10.0
			30.058	40.3	40.0	0.3			0.8	0.5	NE by N.		10.0
			30.052	39.7	39.3	0.4			1.5	1.0	NNE.		10.0
			30.051	40.5	39.3	1.2			1.5	0.5	NNE.		10.0
			29.988	40.1	39.7	0.4			2.2	0.0			10.0
			30.000	40.0	39.7	0.3			0.5	0.2	NE by N.	ENE.	10.0
			30.011	40.2	40.0	0.2	41.6		0.2	0.0		ENE.	10.0
Feb. 8	0	0	30.023	41.0	40.5	0.5	39.2		0.2	0.0		ENE.	10.0
			29.996	41.2	40.8	0.4		0.041	0.0	0.0		ENE.	10.0
			29.978	41.3	40.9	0.4			0.0	0.0		ENE.	10.0
			29.979	41.0	41.0	0.0			0.0	0.0		ENE.	10.0
			29.980	40.2	40.2	0.0			0.0	0.0		ENE.	10.0
			29.983	39.8	39.8	0.0			0.0	0.0			10.0
			29.953	38.8	38.0	0.8			0.2	0.2	N by E.		10.0
			29.963	39.1	37.8	1.3	42.1		0.5	0.2	N by E.	NE ?	10.0
			29.996	36.7	36.0	0.7	38.5		2.2	2.2	N by E.	NE by N.	10.0
Feb. 9	0	0	30.002	38.0	34.8	3.2		0.043	3.2	3.0	N by E.	NNE.	9.5
			29.998	36.7	33.5	3.2			3.5	1.5	N.	NNE.	10.0
			29.993	35.4	32.4	3.0			3.0	2.2	N by E.	NNE.	9.9
			29.992	34.8	31.5	3.3			3.5	2.0	N.	NNE.	9.8
			29.998	33.1	31.8	1.3			3.0	2.0	N by E.	NNE.	7.0
			30.005	34.2	31.9	2.3			2.8	...	N by E.	N by E.	9.9
			29.967	33.2	32.5	0.7			3.2	0.2	NNE.		8.0
			980	33.9	31.7	2.2	36.4		1.2	0.5	NNE.	NNE.	8.0
			980	34.9	32.8	2.1	31.5		2.5	0.8	NNE.	NE.	2.5
Feb. 10	0	0	986	37.1	33.2	3.9		0.095	1.5	1.2	NNE.	NNE ?	3.3
			956	38.3	34.8	3.5			2.8	0.8	NNE.	NNE.	9.2
			958	37.6	34.5	3.1			2.0	1.0	NE by N.	NE by N.	9.9
			963	37.1	34.1	3.0			1.2	1.0	NE by N.		10.0
			983	36.7	34.0	2.7			1.2	1.0	NE by N.	NE.	9.5
			995	37.1	33.7	3.4			1.0	0.8	NE by N.	NE.	10.0
			29.986	37.0	33.3	3.7			1.2	0.8	NE.		10.0
			29.998	36.8	33.1	3.7	38.0		1.0	0.2	NE.		10.0
			29.994	37.3	33.0	4.3	32.4		0.5	0.5	NE.	NNE.	10.0
Feb. 11	0	0	30.019	38.0	34.0	4.0		0.006	0.8	0.2	NE.	NE by N.	10.0
			29.999	39.0	34.9	4.1			0.8	0.8	NE.	NE by N.	10.0
			29.995	38.8	35.0	3.8			1.2	1.0	NE.		10.0
			30.001	37.1	34.9	2.2			0.5	0.2	NE.		10.0
			30.030	36.3	35.0	1.3			0.5	0.0		NE by N.	10.0
			30.038	36.3	35.0	1.3			0.2	0.0			10.0
Feb. 12	0	0	38.6 ? 35.3		0.8				
			29.888	28.8	28.3	0.5			0.8	0.0		SSW ?	3.0
			870	30.9	29.7	1.2	40.0		0.0	0.0		SW.	9.9
			854	32.1	30.5	1.6	28.9		0.0	0.0		W.	9.9
Feb. 13	0	0	822	34.9	32.2	2.7		0.021	0.0	0.0		W.	10.0
			766	36.0	33.0	3.0			0.2	0.2	WNW.	W.	9.8
			736	36.8	33.0	3.8			0.8	0.5	WNW.	WNW.	3.5

Feb. 6^d 22^h. Probably no minimum temperature during the night. The reading given is taken from the observations of yesterday afternoon.
 Feb. 8^d 6^h-10^h. No difference between the dry and wet bulbs owing to the mist which has been falling.
 Feb. 12^d 0^h. The maximum temperature is taken from the readings of the dry thermometer yesterday.
 Feb. 12^d 18^h. Although the temperature is considerably below freezing, the snow water in the cistern of the wet bulb has not been frozen this morning.

SPECIES OF CLOUDS, &c.	Observer's Initial.
h.	
19.	B
20. Two currents of scud.	B
22. Scud + cirrous scud to S. ; very thick to E.	W
0. Cirrous scud.	W
2. Scud.	W
4. Light rain, Scotch mist.	B
6. Id. id.	B
8. Id., scud.	W
10. Scud.	W
18. Homogeneous.	W
20. Scud ; light rain.	W
22. Id. id.	B
0. Id. id.	B
2. Id. id.	B
4. Id. id.	W
6. Id. id.	W
8. Id. id.	B
10. Clouds breaking a little, mist gone.	B
18. Very thick and dark.	B
20. Patches of scud, haze.	B
22. Scud ; raining.	W
0. Scud + woolly cirri and cirro-cumuli.	W
2. Id.	W
4. Id., moving from different directions between N. and E.	B
6. Heavy black scud.	B
8. Thin scud, snowing a little.	W
10. Scud.	W
18. Loose scud, about 1½ inch of snow has fallen during the night.	W
20. Id. ; some snow falling.	W
22. Cirrous scud and woolly cirri + a few cumuli to S. ; snowing to N.	B
0. Cirrous scud and woolly cumuli + cumuli to NW.	B
2. Loose cumuli and scud.	B
4. Cirrous scud.	W
6. A shower of fine hail.	W
8. Cirrous scud.	B
10. Id.	B
18.	B
20. Scud.	B
22. Cirrous scud.	W
0. Scud.	W
2. Id.	W
4. Id.	B
6. Id.	W
8. Id.	W
10. Id., light rain.	W
18. Large cirro-cumuli + linear cirri and haze to E.	B
20. Scud.	B
22. Cirrous scud moving slowly.	W
0. Scud, motion scarcely perceptible.	W
2. Id.	W
4. Loose scud.	B

Göttingen Mean Time of Observation.			BARO- METER Corrected.	THERMOMETERS.				RAIN GAUGE.	ANEMOMETER.			Clouds moving from	Quantity of Clouds.
				Dry.	Wet.	Diff.	Max. and Min.		Pressure.		Direction of Wind.		
									Max.	Pres.			
Feb. 13	d. h. m.		in.	°	°	°	°	in.	lbs.	lbs.			1-10.
	6 0		29.677	34.0	32.0	2.0			0.5	0.2			1.0
	8 0		662	32.3	31.2	1.1			0.2	0.0			0.2
	10 0		636	34.2	32.4	1.8			0.2	0.0			2.0
	18 20		29.601	28.7	27.5	1.2			1.2	0.8	N by E.	N ?	9.8
	20 0		599	27.0	25.4	1.6	36.9		2.0	0.5	N.	NNW.	3.5
	22 0		587	27.2	24.5	2.7	25.6		0.2	0.2	N by W.	NNW.	5.0
Feb. 14	0 0		572	26.9	24.2	2.7		0.000	2.2	1.5	N by W.	N by W : WNW.	2.5
	2 0		542	27.0	24.8	2.2			3.0	1.8	NNW. v.		4.0
	4 0		515	25.0	23.6	1.4			2.5	1.8	N by W.		2.0
	6 0		503	24.0	21.9	2.1			1.5	0.5	NNW.		1.0
	8 0		493	24.1	22.9	1.2			0.8	0.5	NNW.		0.5
	10 0		477	23.1	22.0	1.1			0.8	0.2	NNW.		0.1
	18 0		29.357	19.6	19.0	0.6			0.5	0.0			0.2
	20 0		334	19.3	18.0	1.3	28.2		0.0	0.0			0.5
	22 0		320	22.7	20.6	2.1	18.5		0.0	0.0			0.2
Feb. 15	0 0		268	26.3	23.3	3.0		0.000	0.2	0.0			0.2
	2 0		219	28.6	25.4	3.2			0.0	0.0		N by W.	2.5
	4 0		163	28.9	26.0	2.9			0.0	0.0			7.0
	6 0		121	28.1	26.0	2.1			0.0	0.0		W by N.	10.0
	8 0		099	27.3	26.3	1.0			0.0	0.0			9.8
	10 0		096	26.6	25.3	1.3			0.0	0.0			10.0
	18 0		29.047	22.0	21.5	0.5			0.0	0.0			9.5
	20 0		058	22.4	28.2		0.0	0.0		N by W.	5.0
	22 0		082	22.0	20.2	1.8	19.6		0.0	0.0			0.3
Feb. 16	0 0		091	31.2	28.7	2.5		0.000	0.0	0.0		N by E.	6.0
	2 0		086	31.8	28.8	3.0			0.2	0.2	N by W.	N by E.	3.0
	4 0		100	31.8	29.9	1.9			0.2	0.0		N.	3.5
	6 0		130	28.9	27.0	1.9			0.2	0.0			2.0
	8 0		165	23.3	22.0	1.3			0.0	0.0			0.2
	10 0		194	24.4	23.4	1.0			0.0	0.0			7.5
	18 0		29.316	25.8	24.2	1.6			0.5	0.5	N by W.	N by E.	7.0
	20 0		360	27.0	25.8	1.2	33.8		1.0	0.8	N by W.		10.0
	22 0		407	28.0	26.9	1.1	19.7		0.2	0.0		NNE.	7.0
Feb. 17	0 0		440	31.2	30.2	1.0		0.054	0.2	0.0			10.0
	2 0		453	33.8	32.2	1.6			0.0	0.0		NNE.	8.0
	4 0		468	32.2	31.2	1.0			0.2	0.0		NNE.	7.5
	6 0		499	23.9			0.2	0.0		NNE.	2.5
	8 0		520	20.3	20.0	0.3			0.0	0.0			0.5
	10 0		531	18.8	18.0	0.8			0.0	0.0			0.0
	18 0		29.552	8.2	7.0	1.2			0.0	0.0			0.5
	20 0		568	7.3	7.3	0.0	33.6		0.0	0.0			3.0
	22 0		573	13.8	11.8	2.0	6.9		0.0	0.0		NE.	0.5
Feb. 18	0 0		580	24.6	24.0	0.6		0.001	0.0	0.0		NE.	8.5
	2 0		566	32.4	30.0	2.4			0.0	0.0			8.5
	4 0		534	31.7	30.2	1.5			0.0	0.0		NE.	9.0
	6 0		534	24.4			0.5	0.0			3.5
	8 0		537	24.0	21.3	2.7			0.0	0.0			0.5
	10 0		534	24.4	23.7	0.7			0.0	0.0			1.0
Feb. 19	0 0		36.4 18.2		0.5				
	18 0		29.321	35.7	32.0	3.7			1.5	1.0	NE by E.		10.0
	20 0		318	36.1	32.8	3.3	37.8		1.2	1.0	NE by E.		10.0
	22 0		320	36.7	33.3	3.4	30.5		2.5	1.8	ENE.		10.0

SPECIES OF CLOUDS, &c.

Observer's
Initial.

h.		
6.	Flocculent cirri to W., red ; haze to E., reddish.	B
8.	A few patches of cirrous clouds to E.	W
10.	Linear cirri pointing from WNW. to ENE. A lunar corona about $1\frac{1}{2}^{\circ}$ radius.	W
18.	Scud.	W
20.	Cirrous scud.	W
22.	Loose cumuli ; a few flakes of snow a little ago.	B
0.	Loose-edged cumuli : fine woolly and linear cirri.	B
2.	Id., with cumulo-strati ; cirro-strati to SW. ; snow falling from some of the cumuli to E.	B
4.	Scud and loose cumuli on horizon.	W
6.	Id., from NW. to NE., cirro-strati to SE.	W
8.	Loose cumuli on E. horizon.	B
10.	A patch of cirro-stratus to SE.	B
18.	Cirro-stratus on SE. horizon.	B
20.	Cirro-strati and cumulo-strati on E. and SE. horizon.	B
22.	Ranges of cumuli on horizon from N. to E.	W
0.	Id.	W
2.	Thin woolly cirri to NW., like haze near the horizon + cumulo-strati on NE. horizon.	W
4.	Woolly and tangled cirri, apparently dropping to E. and S. ; cumuli on horizon.	B
6.	Cirrous scud, a few flakes of snow.	B
8.	Id., cumulo-strati on horizon to E.	W
10.	Id.	W
18.	Scud.	W
20.	Cirrous scud + large and beautiful masses of cumuli and cumulo-strati on horizon from N. to E., some of [them tinged with red.	W
22.	Range of cumuli on E. horizon.	B
0.	Cirrous scud + cumuli on E. and N. horizon ; snowing to E.	B
2.	Loose-edged cumuli and cumulo-strati.	B
4.	Masses of cirrous scud + cirrous-edged loose cumuli to E., cumuli to S.	W
6.	Large masses of cumuli and cumulo-strati to S., and on horizon from N. to E.	W
8.	A few patches of clouds on N. horizon.	B
10.	Loose cumuli.	B
18.	Cirrous scud + cumuli to NE. ; a few flakes of snow during the night.	B
20.	Scud, light fall of snow.	B
22.	Id. + loose cumuli to NE. ; light shower of snow 10 ^m ago.	W
0.	Id. ; a shower of snow.	W
2.	Cirrous scud + cumuli on horizon from N to E. ; snowing since last observation till within 15 ^m .	W
4.	Cirrous scud + beautiful ranges of cumuli on N. and E. horizon.	B
6.	Scud + beautiful cumulo-strati to SE., some with cirrous crowns ; splendid pyramidal cumuli on N. hori-	B
8.	Patches of scud ; a few flakes of snow. [zon ; sky hazy, red to E. and NE.	W
10.	Clear.	W
18.	Some patches of scud.	W
20.	Cumuli and cumulo-strati on horizon from NW. to E. and to S., linear cirri to S. pointing towards ENE., [masses of scud.	W
22.	A few patches of scud + cumuli on N. horizon.	B
0.	Large masses of cirrous-edged cumuli + piles of cumuli to N.	B
2.	As before ; snowing to N. ?	B
4.	Scud + woolly cirri to S., cumuli on S. horizon ; beginning to snow.	W
6.	Masses of scud, woolly cirri, loose cumuli round the horizon.	W
8.	Patches of clouds to N.	B
10.	Snowing lately.	B
18.	Homogeneous.	W
20.	Id., a few flakes of snow.	W
22.	A sort of hail-snow falling.	B

Göttingen Mean Time of Observation.			BARO- METER Corrected.	THERMOMETERS.				RAIN GAUGE.	ANEMOMETER.			Clouds moving from	Quan- tity of Clouds.
				Dry.	Wet.	Diff.	Max. and Min.		Pressure.		Direction of Wind.		
									Max.	Pres.			
Feb. 20	d. h. m.		in.	°	°	°	°	in.	lbs.	lbs.			0-10.
	0 0		29.335	36.8	33.8	3.0		0.062	2.5	2.0	ENE.		10.0
	2 0		321	36.8	33.4	3.4			2.2	2.2	ENE.		10.0
	4 0		319	36.0	33.0	3.0			2.5	1.8	ENE.		10.0
	6 0		327	35.8	32.6	3.2			3.8	1.8	ENE. v.		10.0
	8 0		338	36.3	32.8	3.5			2.5	0.5	ENE?		10.0
	10 0		342	34.3	33.2	1.1			2.2	1.5	E by N.		10.0
	18 0		29.288	34.9	34.7	0.2			2.5	1.2	ENE.		10.0
	20 0		310	35.0	34.6	0.4	36.8		1.0	0.5	NE by E.	ENE.	10.0
	22 0		313	35.2	35.0	0.2	31.4		1.5	1.5	ENE.	ENE.	10.0
Feb. 21	0 0		341	36.3	35.8	0.5		0.151	1.5	0.2	ENE?		10.0
	2 0		328	36.0	35.7	0.3			0.5	0.2	NE by E?		10.0
	4 0		320	36.4	36.0	0.4			0.5	0.5	NE by N.		10.0
	6 0		326	36.9	36.2	0.7			0.8	0.8	E by N.	E by S.	10.0
	8 0		348	37.2	36.6	0.6			0.8	0.2			10.0
	10 0		351	37.2	36.4	0.8			0.2	0.2	NE?		10.0
	18 0		29.316	36.0	35.8	0.2			0.5	0.2	NE by N.		10.0
	20 0		316	36.4	35.4	1.0	37.3		0.5	0.2	NE by N.		10.0
	22 0		313	36.8	36.2	0.6	34.0		0.5	0.2			10.0
Feb. 22	0 0		312	37.8	37.1	0.7		0.053	0.8	0.5	NE by N.		10.0
	2 0		286	38.1	37.7	0.4			0.8	0.5	NE by E?		10.0
	4 0		282	37.9	37.4	0.5			0.8	0.5	NE by E?		10.0
	6 0		288	37.5	37.2	0.3			0.5	0.2	NE by E.		10.0
	8 0		303	37.4	37.1	0.3			0.8	0.5	NE.		10.0
	10 0		319	37.2	36.9	0.3			0.5	0.5	NE by E.		10.0
	18 0		29.339	36.1	35.5	0.6			1.0	1.0	NE by N.		10.0
	20 0		367	36.0	35.4	0.6	38.1		1.0	0.5	NE by N.	ENE.	10.0
	22 0		379	37.0	36.3	0.7	35.0		0.8	0.8	NE.		10.0
Feb. 23	0 0		391	37.9	37.1	0.8		0.194	1.0	0.8	NE.		10.0
	2 0		390	37.4	37.1	0.3			1.2	0.5	NE.		10.0
	4 0		391	37.1	36.7	0.4			1.2	0.8	NE.		10.0
	6 0		410	36.3	35.7	0.6			1.2	0.8	NE by N.		10.0
	8 0		440	36.0	35.7	0.3			1.2	0.8	NE.		10.0
	10 0		457	36.8	36.5	0.3			1.2	0.8	NE by N.		10.0
	18 0		29.526	37.8	37.3	0.5			0.8	0.0		E.	10.0
	20 0		535	37.7	37.2	0.5	37.7		0.0	0.0			10.0
	22 0		550	37.9	37.6	0.3	35.3		0.2	0.0			10.0
Feb. 24	0 0		562	39.6	38.5	1.1		0.144	0.2	0.2	ENE.	E by S.	10.0
	2 0		566	39.1	37.9	1.2			0.5	...		E by S.	10.0
	4 0		564	39.3	38.0	1.3			0.2	0.0		E.	10.0
	6 0		572	37.8	36.3	1.5			0.2	0.0		E.	10.0
	8 0		583	36.0	34.8	1.2			0.0	0.0			8.5
	10 0		586	35.6	34.7	0.9			0.0	0.0			10.0
	18 0		29.581	34.7	33.8	0.9			0.0	0.0			10.0
	20 0		594	33.0	32.4	0.6	39.4		0.0	0.0		SSE: N.	9.0
	22 0		590	35.5	34.0	1.5	34.2		0.0	0.0		E by N.	10.0
Feb. 25	0 0		579	36.6	34.3	2.3		0.014	0.0	0.0		E.	10.0
	2 0		559	37.6	35.4	2.2			0.0	0.0			10.0
	4 0		547	35.3	34.5	0.8			0.2	0.0		E.	10.0
	6 0		547	35.3	34.1	1.2			0.0	0.0		E.	10.0
	8 0		571	34.4	33.4	1.0			0.0	0.0			10.0
	10 0		551	33.3	32.8	0.5			0.0	0.0			10.0
Feb. 26	0 0		37.2 32.7		0.3				

SPECIES OF CLOUDS, &c.	Observer's Initial.
h.	
0. A few flakes of snow.	B
2. Light shower of hail-snow.	B
4. A few small hail-stones.	W
6. A few flakes of snow.	W
8.	B
10. Id.	B
18. Light rain.	W
20. Scud; a few drops of rain.	W
22. Id.; id.	B
0. Id.; id.	B
2. Id.; id., a Scotch mist.	B
4. Scotch mist.	W
6. Scud; clouds breaking to SE., cirrous clouds seen.	W
8.	B
10.	B
18. Scotch mist.	W
20. Id.	W
22. Id.	B
0. Id.	B
2. Id.	B
4. Id.	W
6. Id.	W
8. Id.	W
10. Id.	W
18. Light rain.	B
20. Scud; light rain; cirrous clouds seen.	B
22. Id.; id.	W
0. Id.; id.	W
2. Id.; id.	W
4. Id.; id.	W
6. Id.; id.	W
8. Id.; id.	W
10. Id.; id.	W
18. Light rain.	B
20. Scud + cirrous clouds seen above.	B
22. Scotch mist.	W
0. Scud + cirrous clouds.	W
2. Id.; a few drops of rain.	W
4. Id.; light rain.	W
6. Id.; id.	W
8. Id.	W
10. Id., a lightish appearance to N., Auroral light?	W
18. Id.	W
20. Cirrous scud: woolly cirri, single patches in zenith resembling fleeces of wool; heavy cloud to E.	H
22. Cirrous scud.	H
0. Id. + patches of loose scud.	W
2. Scud; thick to NE.	H
4. Cirrous scud; hail lately.	W
6. Loose scud + cirrous clouds.	W
8. Very dark.	D
10. Id.	D

Göttingen Mean Time of Observation.			BARO- METER. Corrected.	THERMOMETERS.				RAIN GAUGE.	ANEMOMETER.			Clouds moving from	Quan- tity of Clouds.
				Dry.	Wet.	Diff.	Max. and Min.		Pressure.		Direction of Wind.		
									Max.	Pres.			
Feb. 26	d. 18	m. 0	29.094	34.7	32.3	2.4	°	in.	lbs.	lbs.			0-10.
	20	0	29.071	33.7	32.0	1.7			1.2	0.8	NE by N.		10.0
	22	0	29.056	34.3	33.2	1.1	39.3		1.0	1.0	NE.	ENE: ENE.	10.0
Feb. 27	0	0	29.015	36.9	34.2	2.7	32.6		2.2	1.2	NE.		9.8
	2	0	28.973	39.0	35.7	3.3		0.000	1.2	1.2	NE.	ENE.	8.0
	4	0	28.962	37.7	36.0	1.7			1.8	1.0	NE.	ENE.	9.9
	6	6	28.972	35.6	33.1	2.5			2.5	1.5	NE.	ENE.	8.0
	8	0	28.991	34.8	31.9	2.9			1.8	0.5	NE.	ENE.	6.0
	10	0	29.001	33.5	32.9	0.6			0.8	0.8	NE.		8.0
	18	0	29.046	33.6	32.5	1.1			1.5	1.0	NE.		10.0
	20	0	085	34.3	32.3	2.0			1.8	0.2	NE by N.		4.0
	22	0	139	35.1	33.9	1.2	39.3		0.5	0.2	NE by N.	ENE.	9.5
Feb. 28	0	0	194	35.8	35.0	0.8	32.7		1.0	0.2	NE by N.	NE by E.	5.0
	2	0	234	38.3	34.4	3.9		0.042	1.8	0.5	NE by N.	NE by E.	9.0
	4	0	276	36.0	33.6	2.4			0.5	0.8	NNE.	NE by E.	8.5
	6	0	329	34.6	31.5	3.1			2.0	0.2	NE by N.	NE by E.	4.0
	8	0	387	32.2	30.0	2.2			1.2	0.2	NE by N.	NE by E.	7.0
	10	0	428	31.2	30.9	0.3			0.2	0.0			3.0
	18	0	29.524	28.2	27.0	1.2			0.2	0.0	NNW.		10.0
	20	0	566	29.9	29.3	0.6			0.8	0.0			1.0
	22	0	608	31.3	29.7	1.6	39.3		0.8	0.0			7.0
Mar. 1	0	0	639	33.8	31.2	2.6	26.4		0.5	0.2	N by W?	NNE.	3.0
	2	0	652	36.6	33.3	3.3		0.091	0.2	0.2	N by W.		1.5
	4	0	676	35.7	32.3	3.4			0.8	0.2	N by W.		9.5
	6	0	699	33.9	31.4	2.5			1.0	1.0	N.		3.5
	8	0	732	31.6	30.2	1.4			0.5	0.0		N?	5.0
	10	0	754	33.0	30.5	2.5			0.2	0.0			9.8
	18	0	29.824	29.8			0.2	0.2	N by W.		5.0
	20	0	854	30.7	29.0	1.7			0.5	0.0	N.	N.	10.0
	22	0	868	34.7	31.2	3.5	37.3		0.2	0.2	N.	N.	9.0
Mar. 2	0	0	898	34.8	31.8	3.0	28.5		0.2	0.2	N.	NNE.	9.9
	2	0	894	36.8	33.0	3.8		0.000	1.2	0.5		NNE.	10.0
	4	0	904	36.2	32.4	3.8			0.8	0.5	N by W.		9.0
	6	0	913	35.2	32.3	2.9			1.0	1.2	N.		6.0
	8	0	939	35.0	31.8	3.2			1.0	0.2	N.	N.	10.0
	10	0	949	34.0	31.3	2.7			0.2	0.2	N.		10.0
	18	0	29.958	32.8	30.7	2.1			0.5	0.0			8.0
	20	0	29.973	33.2	31.1	2.1			0.2	0.0			10.0
	22	0	29.995	34.3	31.1	3.2	36.7		0.2	0.2	N by W.	NE.	7.0
Mar. 3	0	0	30.007	36.3	33.0	3.3	29.7		0.5	0.2	N by E.	N.	3.0
	2	0	30.023	38.0	34.2	3.8		0.000	0.2	0.2		N.	6.0
	4	0	30.017	37.8	34.3	3.5			0.5	0.2	N.	NNE.	8.0
	6	0	30.037	36.6	33.6	3.0			0.0	0.0		NNE.	9.0
	8	0	30.078	33.9	31.7	2.2			0.0	0.0			8.0
	10	0	30.095	35.0	31.5	3.5			0.0	0.0			10.0
	18	0	30.111	23.8	22.9	0.9			0.0	0.0			0.0
	20	0	137	20.9	20.3	0.6			0.0	0.0			0.0
	22	0	149	28.4	26.9	1.5	38.1		0.0	0.0			0.5
Mar. 4	0	0	141	35.9	33.0	2.9	20.2		0.0	0.0		NW?	1.0
	2	0	112	39.6	35.2	4.4		0.000	0.0	0.2	W.		0.2
	4	0	104	41.0	35.6	5.4			0.5	0.2	WSW.		1.0
	6	0	083	36.4	34.2	2.2			0.5	0.0			7.0
	8	0	091	33.0	31.3	1.7			0.2	0.2	SW by W.		0.0
	10	0	083	31.7	30.6	1.1			0.5	0.2	SW by W.		0.3

SPECIES OF CLOUDS, &c.

Observer's
Initial.

h.	
18.	Scud ; a slight sprinkling of snow has fallen during the night.
20.	Id : linear cirri ; very fine snow beginning to fall.
22.	Nearly as before ; fine snow ; sky to NE.
0.	Scud + woolly cirri, cumulo-strati on NE. horizon.
2.	Large masses of loose cumuli and scud.
4.	Scud + woolly cirri and large cirro-cumuli, cumuli on NE. horizon.
6.	Scud on horizon + large cirro-cumuli, loose cumuli and cumulo-strati on horizon.
8.	
10.	Occasional slight showers of snow.
18.	Scud ; a large mass of clouds to E.
20.	Loose scud + cirrous clouds.
22.	Loose cumuli + fine cumuli to NE. and E.
0.	Loose cumuli and scud ; snow and hail lately.
2.	Id.
4.	Masses of scud and cumuli + fine mottled cirri.
6.	Loose scud + cirro-strati to N., loose cumuli on N. and NE. horizon.
8.	Thin scud to NW.
10.	A slight fall of snow since last observation.
18.	Scud to E. ; $\frac{3}{4}$ inch of snow has fallen during the night.
20.	Snowing.
22.	Cirrous scud.
0.	Loose cumuli to SE. and cirri to S.
2.	As before.
4.	Scud to W. ; cirri ; cumuli and cumulo-strati on horizon from N. to E.
6.	Thin scud + thick cirrous clouds to NE. ; cirri and cumuli to S.
8.	
10.	Scud.
18.	Id.
20.	Cirro-cumulous scud + woolly cirri and cirro-cumuli.
22.	Id.
0.	Id.
2.	Id.
4.	Scud and loose cumuli, woolly cirri ; cumuli to N. and W.
6.	Cirro-cumulous scud + cirrous clouds.
8.	
10.	
18.	
20.	Cirro-cumulous scud.
22.	Id.
0.	Woolly cirri lying in lines radiating from N. ; cumulo-strati on NE. horizon.
2.	Loose cumuli + woolly cirri and cirrous haze.
4.	Scud + fine woolly cirri.
6.	Id. + id.
8.	
10.	
18.	Haze on E. horizon.
20.	Thin cirrous haze to E.
22.	Id., and N. 23 ^h , Thermometer exposed to the sun 65°.
0.	Network and beautifully mottled cirri, moving very slowly ; cirrous haze round horizon.
2.	A few patches of cirrous clouds near horizon to E. and S.
4.	Very fine curled and mottled cirri, patches of loose cumuli to S. and E. ; haze on E. and N. horizon.
6.	Linear cirri pointing towards NNE., woolly, striated, and reticulated cirri ; haze to N.
8.	Thin haze to W. ; a small corona round the moon.
10.	A bank of clouds on N. horizon.

Göttingen Mean Time of Observation.			BARO- METER. Corrected.	THERMOMETERS.				RAIN GAUGE.	ANEMOMETER.			Clouds moving from	Quan- tity of Clouds.
				Dry.	Wet.	Diff.	Max. and Min.		Pressure.		Direction of Wind.		
									Max.	Pres.			
d.	h.	m.	in.	°	°	°	°	in.	lbs.	lbs.		0-10.	
Mar.	5	0 0	41.2 ? 29.0		1.3				
		18 0	29.919	36.1	35.1	1.0			2.5	0.0			7.0
		20 0	925	37.3	36.4	0.9			0.0	0.0			9.5
		22 0	925	43.1	40.6	2.5			0.0	0.0			9.5
Mar.	6	0 0	921	46.0	43.1	2.9			0.0	0.0		SSW.	9.5
		2 0	910	48.4	45.3	3.1		0.000	0.2	0.2	SSW.	SSW.	9.0
		4 0	925	47.8	44.9	2.9			0.8	0.2	SSW ?	SSW.	10.0
		6 0	926	45.0	43.6	1.4			0.2	0.0		SSW.	9.9
		8 0	946	42.8	42.3	0.5			0.2	0.0			10.0
		10 0	957	42.0	40.8	1.2			0.2	0.0			10.0
		18 0	29.970	38.2	37.7	0.5			0.0	0.0			10.0
		20 0	29.978	40.8	39.5	1.3			0.0	0.0			10.0
		22 0	29.982	42.1	40.6	1.5	50.2		0.0	0.0			10.0
Mar.	7	0 0	29.994	45.8	42.7	3.1	34.3		0.2	0.2	S.	S by E.	10.0
		2 0	29.987	44.9	39.8	5.1		0.000	1.2	1.0	S.	S by E.	3.0
		4 0	29.979	45.3	40.0	5.3			1.0	0.8	S.		1.0
		6 0	29.995	40.7	37.3	3.4			0.5	0.2			1.0
		8 0	30.025	34.3	32.7	1.6			0.2	0.0			0.0
		10 0	30.030	32.7	30.6	2.1			0.0	0.0			0.0
		18 0	30.105	24.3	24.0	0.3			0.0	0.0			0.0
		20 0	125	24.0	23.0	1.0			0.0	0.0			0.0
		22 0	143	29.1	28.4	0.7	46.8		0.0	0.0			0.0
Mar.	8	0 0	158	35.0	32.7	2.3	21.2		0.0	0.0			0.0
		2 0	148	41.7	37.7	4.0		0.000	0.0	0.0			0.0
		4 0	135	43.7	39.2	4.5			0.0	0.0			0.0
		6 0	120	41.2	38.1	3.1			0.0	0.0			0.0
		8 0	138	33.3	31.7	1.6			0.0	0.0			0.0
		10 0	148	28.9	27.4	1.5			0.0	0.0			0.0
		18 0	30.148	27.2	26.6	0.6			0.2	0.0			2.5
		20 0	150	29.7	28.8	0.9			0.0	0.0		NW ?	6.0
		22 0	135	33.0	31.3	1.7	44.1		0.0	0.0			1.5
Mar.	9	0 0	120	39.9	37.3	2.6	24.9		0.0	0.0			2.0
		2 0	085	43.3	38.8	4.5		0.000	0.5	0.2	SW.		6.0
		4 0	085	42.6	39.0	3.6			0.5	1.2	WSW ?	SW.	9.0
		6 0	062	38.8	37.0	1.8			0.5	0.0		W by S.	9.0
		8 0	042	38.3	36.6	1.7			0.2	0.0		WSW.	9.9
		10 0	027	36.4	34.7	1.7			0.2	0.0			2.0
		18 0	29.836	35.1	33.6	1.5			0.2	0.0			10.0
		20 0	815	35.1	34.0	1.1			0.0	0.0			10.0
		22 0	784	35.4	34.8	0.6	44.2		0.0	0.0			10.0
Mar.	10	0 0	777	39.2	38.7	0.5	32.1		0.0	0.0			10.0
		2 0	731	36.6	36.3	0.3		0.230	0.0	0.0			10.0
		4 0	728	41.2	40.0	1.2			0.2	0.0		SW by W.	10.0
		6 0	748	40.1	39.6	0.5			0.0	0.0		W by S.	3.0
		8 0	783	34.7	34.6	0.1			0.0	0.0			0.5
		10 0	806	32.7	31.9	0.8			0.0	0.0			0.5
		18 0	29.884	35.8	35.4	0.4			0.0	0.0			10.0
		20 0	908	38.0	37.7	0.3			0.0	0.0			10.0
		22 0	918	42.8	42.0	0.8	44.2		0.0	0.0		W.	9.9
Mar.	11	0 0	902	49.0	46.1	2.9	30.5		0.0	0.0		W.	10.0
		2 0	872	48.9	46.1	2.8		0.013	0.2	0.0		W.	10.0
		4 0	844	48.8	45.6	3.2			0.2	0.2	SW ?	W.	10.0

SPECIES OF CLOUDS, &c.

Observer's
Initial.

h.	Observer's Initial.
18. Cirrous clouds and haze.	B
20. Scud and cirro-strati to E., sky to E.	B
22. Scud, cirro-strati to S. and E.	W
0. Scud + cirro-strati to S. and E.	W
2. Id. + fine woolly cirri; cumulo-strati on horizon from NE. to S.	W
4. Id. + cumuli to E.; patches of sky occasionally.	B
6. Id. + id.	W
8. Id.	W
10. Id.	W
18. Id.	B
20. Id.	W
22. Id. and mist.	W
0. Scud and loose cumuli.	W
2. Cirrous scud, loose cumuli, and cirro-strati.	B
4. Patches of cirrous clouds, hazy on horizon.	B
6. Id. id.	W
8. A distinct auroral arch, altitude 10°, breadth 8°, its crown being in the magnetic meridian; no pencils.	W
10. Clear.	W
18. Id.	B
20. Id.	B
22. Id., cirrous haze on horizon.	W
0. Id., id.	W
2. Id., id.	W
4. Id., id.	W
6. Id., id.	W
8. Id.	W
10. Id.	W
18. Linear cirri or cirrous haze to E.	B
20. Loose cirro-cumuli in zenith + thick woolly cirri to E., very red at 19 ^h ; cymoid cirri at 19 ^h .	B
22. Patches of cirro-cumuli; linear cirri to SW., pointing NW.; cirrous haze on horizon.	W
0. Cirro-cumuli and fine woolly and mottled cirri; haze on horizon. [haze near horizon.]	W
2. Long lines of cirri lying in different directions, but chiefly towards WNW., as if indicating wind; cirrous	W
4. Scud moving quickly + thick cirrous clouds and haze over the sky.	B
6. Cirro-cumulous scud moving slowly + woolly cirri, thick cirrous clouds; cirrous haze on horizon.	W
8. Cirro-cumulous scud.	W
10. Patches of cirrous clouds; faint lunar halo.	W
18.	B
20. Light fall of snow.	B
22. A few drops of sleet.	W
0. Light rain.	W
2. Raining.	W
4. Scud.	W
6. Patches of loose scud + patches of woolly and curled cirri, linear cirri to W. pointing N. and S., cirro-strati and cumuli to NE.; a long mass of [cumulous scud to E., fringed with woolly cirri.]	W
8. Patches of cirrous clouds.	W
10. Id.	W
18.	B
20. Scud.	B
22. Cumulous scud + cirrous clouds seen above to S.	W
0. Id.	W
2. Scud.	W
4. Id. + cirrous haze above.	B

Göttingen Mean Time of Observation.			BARO- METER Corrected.	THERMOMETERS.				RAIN GAUGE.	ANEMOMETER.			Clouds moving from	Quan- tity of Clouds.
				Dry.	Wet.	Diff.	Max. and Min.		Pressure.		Direction of Wind.		
									Max.	Pres.			
Mar. 11	d. h. m.		in.	°	°	°	°	in.	lbs.	lbs.			0-10.
	6 0		29.821	44.5	43.0	1.5			0.5	0.2	SW.	W.	10.0
	8 0		794	42.8	42.1	0.7			0.5	0.5	SW.	W.	10.0
	10 0		766	42.8	42.0	0.8			0.5	0.2	SW.	W.	10.0
Mar. 12	0 0		53.0 42.3		1.5				
	18 0		29.255	37.6	35.3	2.3			1.8	0.5	SW by W.		2.5
	20 0		256	38.4	36.6	1.8			0.5	0.5	WSW.	W.	6.0
	22 0		245	41.7	38.2	3.5	52.2		1.2	1.2	SW by W.		4.0
Mar. 13	0 0		228	43.7	42.2	1.5	35.7	0.013	2.8	1.8	SW by W.	W.	9.5
	2 0		217	43.7	39.4	4.3			5.0	1.0	WNW.	W.	10.0
	4 0		213	42.3	38.7	3.6			2.8	1.2	WNW.	W.	9.9
	6 0		198	40.9	37.8	3.1			1.2	0.2	WNW.		10.0
	8 0		186	39.6	36.4	3.2			0.5	0.2		W.	10.0
	10 0		155	38.9	36.0	2.9			0.5	0.5	WSW.	W.	9.9
	18 0		29.123	31.2	30.3	0.9			0.2	0.0			0.2
	20 0		155	34.6	33.0	1.6			0.0	0.0			0.2
	22 0		182	39.7	36.9	2.8	44.4		0.0	0.0		W.	2.0
Mar. 14	0 0		195	43.0	38.6	4.4	28.5	0.031	0.2	0.0		W.	6.0
	2 0		211	43.8	40.3	3.5			0.8	0.2	WSW.	W.	9.0
	4 0		206	46.7	46.0	0.7			0.8	0.5	SW by W.	W.	7.0
	6 0		215	41.7	38.0	3.7			0.5	0.5	SW by W.	W.	10.0
	8 0		250	38.2	37.0	1.2			0.8	0.2			9.5
	10 0		266	37.7	35.1	2.6			0.2	0.0		W.	3.0
	18 0		29.447	28.3	27.6	0.7			0.5	0.0			1.0
	20 0		501	30.4	29.7	0.7			0.0	0.0		W.	3.0
	22 0		559	37.0	36.2	0.8	47.1		0.0	0.0		WNW.	7.0
Mar. 15	0 0		586	43.2	39.3	3.9	26.8	0.007	0.0	0.0		W by N.	5.0
	2 0		601	47.8	46.6	1.2			0.2	0.0		W.	7.0
	4 0		616	47.3	40.9	6.4			0.5	0.2	SW by W.	W.	9.5
	6 0		637	43.7	40.0	3.7			0.8	0.2		W.	10.0
	8 0		697	39.1	37.1	2.0			0.5	0.2	NE by N.		10.0
	10 0		755	37.2	35.4	1.8			0.5	0.0			10.0
	18 0		29.811	33.5	32.8	0.7			0.0	0.0			10.0
	20 0		824	34.8	33.6	1.2			0.0	0.0			10.0
	22 0		813	39.8	37.7	2.1	49.9		0.2	0.0			10.0
Mar. 16	0 0		795	41.9	39.0	2.9	31.7	0.000	1.0	1.2	SSE.	S.	10.0
	2 0		756	41.0	38.8	2.2			1.2	0.2	SSE.		10.0
	4 0		698	41.3	39.4	1.9			0.8	0.2	S by E.		10.0
	6 0		647	41.9	40.3	1.6			0.2	0.0		S by W.	10.0
	8 0		604	41.6	41.0	0.6			0.8	0.2	SSE.		10.0
	10 0		575	43.2	42.3	0.9			0.5	0.0			10.0
	18 0		29.472	44.6	43.2	1.4			2.8	1.0	SW by S.	SW by S.	10.0
	20 0		496	44.4	43.3	1.1			2.0	0.8	SW.	SW by S.	10.0
	22 0		510	44.7	43.5	1.2	42.9		1.0	0.5	SW.	SW by S.	10.0
Mar. 17	0 0		511	46.8	44.9	1.9	40.9	0.000	1.2	1.0	SW.	WSW.	10.0
	2 0		522	46.8	44.9	1.9			1.8	1.0	SW by W.	WSW.	10.0
	4 0		525	47.6	45.3	2.3			1.5	0.5	SW by W.	WSW.	10.0
	6 0		515	46.3	44.6	1.7			1.7	0.7	SW by W.	SW.	9.0
	8 0		540	45.8	44.1	1.7			1.2	0.0			10.0
	10 0		550	46.1	44.6	1.5			2.5	1.0	SW by W.		10.0
	18 0		29.584	43.1	42.4	0.7			1.2	0.0			8.0

SPECIES OF CLOUDS, &c.

	Observer's Initial.
6. Scud.	W
8. Id.	W
10. Id.	W
18. Masses of scud.	W
20. Loose scud + woolly cirri and cirro-cumuli to E., cumuli and cumulo-strati on horizon.	W
22. Masses of scud to W. and S.; woolly cirri to E.; patches of scud and cumuli on horizon.	W
0. Scud + cirrous clouds to S. and SE.; loose cumuli on N. and S. horizon, a slight shower in 10 minutes.	W
2. As before. [showers around.]	B
4. Scud + loose cumuli on horizon to N. and NE.; passing showers.	W
6. Id.; cirrous clouds; cumuli and cumulo-strati on horizon, light shower.	W
8. Scud, having a cirro-cumulous disposition. [very narrow.]	B
10. Id., id.; cirrous haze above; at 10 ^h 10 ^m a beautiful lunar halo, the ring	B
18. Small patches of scud to N.	W
20. Id.	W
22. Loose cumuli and scud.	B
0. Id.	B
2. Id. + cumulo-strati to N.; rain to S. and SE.	B
4. Masses of scud + loose cumuli on horizon, cirro-strati to E. Sea-gulls seen coming from the sea.	W
6. Scud + cumuli and cumulo-strati on horizon from NE. to S.; slight shower.	W
8. As before; slight shower lately.	B
10. Scud + thin cirrous clouds.	B
18. Cumuli and cumulo-strati on NE. and E. horizon; ground covered with hoar-frost.	W
20. Fine woolly and striated cirri + patches of loose cumuli to S. and E.	W
22. Masses of woolly cirri, curled at the edges, pointing from WNW.; finer cirri above.	B
0. Nearly as before; detached masses of scud and loose cumuli + some of the cirri are linear and flame-like, the lines branching off from the main body, which lies NW. and SE., and point to WSW. or SW.	B
2. Scud, loose cumuli and cumulo-strati + cirrous haze to E. A thermometer in the sun, sheltered from the wind, shewed 85°.	B
4. Loose cumuli + woolly cirro-cumuli.	W
6. Scud + large cirro-cumuli, linear cirri to S., pointing E. and W.; loose cumuli all round the horizon; rain falling to N. from dark scud.	W
8. Scud.	B
10. Id.	B
18. Scud, cirrous clouds above.	W
20. Hazy cirrous clouds; cumuli and cirro-strati on horizon.	W
22. Scud; haze above?	B
0. Patches of scud + thick mass of cirrous haze or cirro-stratus.	B
2. As before; a few drops of rain.	B
4. Scud.	W
6. Id.; a few drops of rain.	W
8. Scotch mist.	B
10. Scud, clouds breaking.	B
18. Scud.	W
20. Id.	W
22. Id.; light rain.	B
0. Id.; id. occasionally.	B
2. Id.	B
4. Id.	W
6. Loose scud + cirrous clouds, linear cirri to S. pointing towards W by N., loose cumuli to N. and E.	W
8. Scud.	B
10. Id.	B
18. Masses of scud to N. and E., woolly cirro-cumuli and woolly cirri lying SW. and NE.; cirro-strati to SE.	W

Göttingen Mean Time of Observation.			BARO- METER Corrected.	THERMOMETERS.				RAIN GAUGE.	ANEMOMETER.			Clouds moving from	Quantity of Clouds.
				Dry.	Wet.	Diff.	Max. and Min.		Pressure.		Direction of Wind.		
									Max.	Pres.			
d.	h.	m.	in.	°	°	°	°	in.	lbs.	lbs.			0-10.
Mar.	17	20 0	29.616	42.2	42.0	0.2	47.8		0.2	0.0			6.0
		22 0	648	49.1	47.2	1.9	41.6		0.2	0.2	SW by W.	W.	9.5
Mar.	18	0 0	669	54.6	50.9	3.7		0.000	0.2	0.0	W.		9.8
		2 0	679	58.1	53.0	5.1			0.0	0.0		W by S.	9.9
		4 0	688	53.4	49.7	3.7			0.2	0.5	NE by E.		9.8
		6 0	708	48.7	46.7	2.0			0.5	0.2	NE.	ENE.	9.0
		8 0	740	44.5	43.8	0.7			0.5	0.2	NE by E.		10.0
		10 0	756	43.7	43.0	0.7			0.2	0.2	NE by N.		10.0
Mar.	19	0 0	61.5 40.5		0.3				
		18 0	29.660	41.0	39.0	2.0			1.2	0.2	E by N.	E.	10.0
		20 0	634	40.5	39.8	0.7			0.2	0.2	E.	E.	10.0
		22 0	611	44.4	42.5	1.9	53.3		0.2	0.0		SSE.	7.0
Mar.	20	0 0	583	48.0	45.1	2.9	39.3		0.5	0.0		SSE.	9.9
		2 0	554	46.4	44.0	2.4		0.000	0.2	0.0		SSE.	10.0
		4 0	502	42.7	41.8	0.9			0.5	0.5	NE by E.	ENE: SE by E: SW by W.	9.0
		6 0	471	40.9	39.9	1.0			0.5	0.2	E.	E by S : SE by E : 0 ?	9.5
		8 0	441	39.7	38.8	0.9			0.2	0.0			9.9
		10 0	412	39.9	39.1	0.8			0.5	0.0			10.0
		18 0	29.212	41.8	41.4	0.4			0.5	0.0		SSE ?	10.0
		20 0	200	43.8	43.0	0.8	50.2		0.0	0.0		SSE.	10.0
		22 0	197	49.8	49.1	0.7	38.6		0.5	0.2	SE by S.	SSE.	9.8
Mar.	21	0 0	189	52.4	49.7	2.7		0.039	1.5	1.0	S by E.	S.	9.5
		2 4	184	54.1	49.2	4.9			1.8	0.8	SSE.	S.	7.0
		4 0	182	54.2	50.0	4.2			0.5	0.2	SE by S.	S.	8.5
		6 0	218	49.3	46.3	3.0			1.0	0.2	SW by S ?	Varying.	9.0
		8 0	220	45.5	44.5	1.0			0.5	0.0		SSW.	10.0
		10 0	200	43.0	42.7	0.3			0.2	0.0			0.0
		18 0	29.127	47.7	45.7	2.0			0.0	0.0		S by W ?	10.0
		20 0	122	47.5	46.0	1.5	57.0		0.2	0.2	S by E.	SSE.	10.0
		22 0	136	48.0	47.0	1.0	42.6		0.8	0.2	S by E.		10.0
Mar.	22	0 0	117	53.7	50.6	3.1		0.290	1.2	1.2	S by E.	SSE.	4.0
		2 0	127	58.0	52.4	5.6			2.5	1.5	S by W.	S by W.	7.0
		4 0	134	59.2	51.8	7.4			1.2	0.8	S by W.	SSW.	7.0
		6 0	175	54.0	48.8	5.2			0.2	0.2	S by W.	SSW.	7.5
		8 0	219	47.7	45.6	2.1			0.0	0.0		S.	5.0
		10 0	239	46.2	44.7	1.5			0.0	0.0			8.0
		18 0	29.143	48.8	46.8	2.0			2.0	0.2		ESE.	10.0
		20 0	170	48.9	47.0	1.9	58.8		1.2	0.8	E by S.	SSE.	10.0
		22 0	159	45.8	42.2	3.6	45.3		0.2	0.0	NNE.	SSE.	10.0
Mar.	23	0 0	184	48.2	48.0	0.2		0.125	0.0	0.0		SSE.	10.0
		2 0	205	55.4	52.0	3.4			0.5	0.8	SE by S.	S by E.	7.0
		4 0	236	53.7	51.0	2.7			1.2	0.8	SSE.	E by S ?	10.0
		6 0	311	51.2	48.7	2.5			1.2	0.0			6.0
		8 0	374	44.7	43.2	1.5			0.2	0.0			0.5
		10 0	421	41.2	40.8	0.4			0.0	0.0			5.0
		18 0	29.527	39.8	39.8	0.0			0.0	0.0			10.0 ?
		20 0	556	42.6	42.2	0.4	55.3		0.2	0.2	NE by N.		10.0
		22 0	571	44.1	43.7	0.4	36.2		0.5	0.5	E by N.		10.0
Mar.	24	0 0	591	45.7	44.9	0.8		0.062	0.2	0.8	NE.	E by S.	10.0
		2 0	592	43.7	42.4	1.3			1.8	1.8	ENE.	E by N.	10.0

SPECIES OF CLOUDS, &c.

Observer's
Initial.

h.		
20.	Woolly cirri, cirro-cumuli, and fine linear cirri, all lying WSW. to ENE.; masses of loose cumuli near horizon all round, cumulo-strati to E.	W
22.	A few patches of scud + loose cumulo-strati; cirrous haze.	B
0.	Patches of scud; large loose cirro-cumuli; cumulo-strati to NNE.	B
2.	Masses of scud + cumulo-strati above cumuli to N. and E.	W
4.	Large loose cirro-cumuli; cirrous haze.	W
6.	Patches of scud moving quickly + lines of cirro-strati and linear cirri rising from a semicircular nucleus on E. horizon and radiating from that [point.	W
8.		B
10.		B
18.	Scud.	B
20.	Thick scud; breaking to ENE. where cirrous clouds are seen above.	B
22.	Loose scud + patches of woolly cirri; ranges of loose cumuli to S. and E.	W
0.	Scud + cirrous clouds.	W
2.	Thick scud; raining to NW.	W
4.	Thin misty scud apparently close to the ground and moving very rapidly: thick scud moving less quickly: woolly cirri moving very slowly; [the horizon seems covered with the thin scud.	B
6.	Thin scud: scud: cirrous clouds.	B
8.	Scud.	W
10.	Id.	W
18.	Id.; light rain.	B
20.	Id.	B
22.	Id. + woolly cirro-cumuli and fine linear cirri lying N. and S.; cumulo-strati and loose cumuli near [horizon.	W
0.	Scud and loose cumuli + woolly cirri and cirro-cumuli.	W
2.	Detached masses of cumuli + cirro-cumuli.	W
4.	Scud and masses of woolly cirro-cumuli.	B
6.	A large mass of electric clouds moved up from SSW.; at first the W. was covered, but the tendency of the whole is towards the E.; the clouds at first appeared to be acted on by several currents, now they appear to move from SSE. and SE.; large drops of rain; sky to E. with beau- [tiful cumulo-strati to SSE.	B
8.	Heavy showers, scud.	B
10.	Clear.	W
18.	Scud in different strati, moving very slowly + cumulo-strati and cirro-strati to E., the latter quite red.	B
20.	Scud; light rain.	B
22.	Raining.	W
0.	Patches of cirrous scud + A mass of clouds covers the sky from NW., by E. to SE. to an altitude of 40°, curled cirri at the edges, apparently becoming haze to NE.; cumulo-strati near horizon; cumuli to SW.	W
2.	Detached masses of loose cumuli + the sky almost completely covered with thin crossed woolly cirri; cirrous haze on E. horizon.	W
4.	Masses of loose cumuli and cumulo strati + woolly cirrous clouds.	B
6.	Large masses of cumulo-strati + cirrous clouds.	B
8.	Thick masses of scud.	W
10.		H
18.	Scud.	H
20.	Id.	H
22.	Id.; smart shower.	B
0.	Id. + cumulo-strati to S.; breaking to S.	W
2.	Id.	D
4.	Id.; light rain.	W
6.	Hazy clouds on E. horizon.	H
8.	Small patches of scud; cirrous haze on horizon.	W
10.	Scud.	D
18.	Thick fog.	B
20.	Fog clearing off.	B
22.	Fog.	W
0.	Scud; light rain.	W
2.	Scud; raining lately; clearing to S.	W

Göttingen Mean Time of Observation.			BARO- METER Corrected.	THERMOMETERS.				RAIN GAUGE.	ANEMOMETER.			Clouds moving from	Quan- tity of Clouds.
				Dry.	Wet.	Diff.	Max. and Min.		Pressure.		Direction of Wind.		
d.	h.	m.	in.	°	°	°	°	in.	lbs.	lbs.			
Mar. 24	4	0	29.614	43.0	41.0	2.0			2.2	0.8	E by N.	E by S.	0-10.
	6	0	650	42.9	41.0	1.9			0.8	0.2	E by N.	ESE.	10.0
	8	0	687	42.8	40.9	1.9			0.5	0.2	E by N.	ESE.	10.0
	10	0	696	43.1	40.8	2.3			0.8	0.5	E by N.		10.0
	18	0	29.796	42.3	40.0	2.3			0.8	0.2	ENE.	SE.	10.0
	20	0	842	42.2	40.0	2.2			0.2	0.2	ENE.	S.	9.5
Mar. 25	22	0	864	42.9	40.3	2.6	45.1		0.8	0.8	ENE.	E by S : E by S.	9.9
	0	0	875	46.0	42.2	3.8	41.5	0.000	1.0	0.5	ENE.	E by S.	3.5
	2	0	884	46.3	41.7	4.6			1.8	2.2	ENE.	E by N : E.	3.5
	4	0	880	42.2	38.3	3.9			3.0	2.2	E by N.	ESE.	2.0
	6	0	910	41.2	38.0	3.2			3.0	1.2		W.	2.0
	8	0	924	37.7	35.9	1.8			1.0	0.2	NE.		0.0
Mar. 26	10	0	928	36.6	35.6	1.0			1.0	1.2	NE.		0.0
	0	0	46.4		2.0				
							34.5						
	18	0	29.808	34.0	32.0	2.0			4.0	1.8	ENE.	E by S.	10.0
	20	0	810	34.3	31.9	2.4			1.5	0.5	ENE.	E by S.	10.0
	22	0	814	35.1	32.8	2.3	45.5		2.0	...	E by N.	E.	10.0
Mar. 27	0	0	812	36.1	33.9	2.2	32.3	0.055	2.8	1.2	E by N.	E.	10.0
	2	0	811	35.0	33.0	2.0			2.2	1.5	E by N.	E by S.	10.0
	4	0	790	35.6	32.7	2.9			2.2	1.5	ENE.	E by S.	10.0
	6	0	783	35.4	32.3	3.1			1.5	1.0	E by N.	E.	10.0
	8	0	791	34.8	31.6	3.2			1.2	0.8	E by N.		10.0
	10	0	784	34.2	31.6	2.6			1.2	0.5	E by N.		10.0
Mar. 28	18	0	29.751	35.3	32.9	2.4			0.8	0.0		E.	9.9
	20	0	760	36.2	33.4	2.8			0.0	0.0		E.	9.9
	22	0	768	39.0	35.6	3.4	36.0		0.5	0.5	E.	E.	9.5
	0	0	764	41.4	37.0	4.4	33.6	0.000	1.2	0.8	E by N.	E.	9.0
	2	0	770	42.6	38.0	4.6			1.0	0.5	ENE.	E.	8.0
	4	0	765	40.0	35.6	4.4			1.0	0.5	E by N.	E by N.	5.0
Mar. 29	6	0	771	38.7	35.0	3.7			...	0.5	ENE.	E.	2.0
	8	0	794	34.2	32.3	1.9			0.5	0.0		E.	3.0
	10	0	804	30.5	29.4	1.1			0.0	0.0		SE?	2.0
	18	0	29.842	24.1	23.7	0.4			0.0	0.0			1.5
	20	0	858	27.9	27.3	0.6	42.9		0.0	0.0		E by N.	3.0
	22	0	857	33.2	31.6	1.6	22.9		0.0	0.0		E : WNW.	2.5
Mar. 30	0	0	858	41.0	38.4	2.6			0.0	0.0		Various : NE?	1.5
	2	0	836	44.7	40.0	4.7			0.0	0.0			0.5
	4	0	823	47.1	42.0	5.1			0.5	0.0		S.	0.2
	6	0	792	45.8	40.3	5.5			0.2	0.0			0.1
	8	0	802	36.0	33.6	2.4			0.0	0.0			0.0
	10	0	777	33.9	32.5	1.4			0.0	0.0			0.0
Mar. 31	18	0	29.663	26.6	26.6	0.0			0.0	0.0			0.5
	20	0	610	29.3	29.0	0.3	48.9		0.0	0.0			0.4
	22	0	567	37.0	35.4	1.6	24.7		0.0	0.0			9.5
	0	0	518	43.6	39.3	4.3			0.0	0.0			10.0
	2	0	436	48.2	44.7	3.5			0.0	0.0		S by W.	8.6
	4	0	340	50.0	45.3	4.7			0.2	0.2	SE.	S by W?	10.0
Mar. 31	6	0	260	46.6	44.3	2.3			0.5	0.0		S.	10.0
	8	0	177	46.8	45.2	1.6			0.5	0.0			10.0
	10	0	108	47.8	46.7	1.1			0.5	0.5	S by E.		10.0
	18	0	28.969	46.4	44.3	2.1			3.5	3.8	SW.	SW by W.	3.0

SPECIES OF CLOUDS, &c.

Observer's
Initial.

h.		
4.	Scud.	B
6.	Id.	B
8.	Id.	W
10.	Dark.	W
18.	Different strata of clouds, the lowest scud ; a few drops of rain.	B
20.	As before ; no rain.	B
22.	Scud : cirrous scud + cirrous clouds.	W
0.	Id. + patches of woolly cirro-cumuli to S.	W
2.	Id. : scud + loose cumuli on horizon.	W
4.	Scud or loose cumuli.	B
6.	Loose cirrous clouds, chiefly to E., moving very slowly.	B
8.	Clear.	W
10.	Id. ; several shooting stars seen.	W
18.	Scud ; snowing ; a small quantity of snow has fallen during the night.	W
20.	Id. ; a few flakes of snow.	W
22.	Id. id.	B
0.	Id.	B
2.	Id.	W
4.	Id.	W
6.	Id.	W
8.	Id.	W
10.	Id.	B
18.	Id.	W
20.	Id.	W
22.	Scud or loose cumuli in large masses.	B
0.	Id. id.	B
2.	Id. id.	W
4.	Id. id.	W
6.	Detached masses of loose cumuli and scud.	W
8.	Id.	W
10.	Scud ?	B
18.	Patches of loose cumuli to W. ; cumulo-strati on E. horizon ; cirrous haze to S.	W
20.	Thin scud + cumulo-strati to N. ; linear cirri to S. lying ESE. to WNW. [NW. to SE.]	W
22.	Detached patches of loose cumuli in strata on N. and E. horizon : linear cirri lying and pointing from	B
0.	Masses of cirrous scud, some of which at an altitude of about 80° from ENE. is evidently in an eddy, as the mass remains nearly stationary, whilst its parts move in all directions, tending principally towards NE., but vanishing in its evolutions : linear cirrous clouds.	B
2.	Patches of cirrous clouds ; patches of cumuli to N.	B
4.	Patches of cirrous scud to W., which grow quickly into larger masses and then disappear + small patches of cumuli to N.	W
6.	Cirrous clouds on E. horizon.	W
8.	Clear.	W
10.	Id. An auroral arch, the crown to NNW., altitude 15° ; it shortly loses the form of the arch ; no streamers.	W
18.	Cumulo-strati on E. horizon ; cirrous haze all round the horizon ; much hoar-frost.	W
20.	Chiefly woolly cirri ; indistinct linear cirri in cirrous haze to N., lying ESE. to WNW. ; cirrous haze all	W
22.	Thick mass of cirrous clouds and haze. [round the horizon.]	B
0.	Id.	W
2.	Cirrous scud + cumulo-strati to N. and E. ; loose cumuli to S. ; cirrous haze.	W
4.	Small patches of cirrous scud + long lines of linear cirri to NE. lying NNW. to SSE., curled to S. ; sky covered with cirrous haze.	W
6.	Loose scud ; cirrous haze ; light rain till 5 ^h 50 ^m .	W
8.	Scotch mist.	B
10.	Id.	B
18.	Masses of scud moving quickly + fine linear cirri to NE. pointing NNW. ; cirrous haze.	W

Göttingen Mean Time of Observation.			BARO- METER Corrected.	THERMOMETERS.				RAIN GAUGE.	ANEMOMETER.			Clouds moving from	Quantity of Clouds.
				Dry.	Wet.	Diff.	Max. and Min.		Pressure.		Direction of Wind.		
									Max.	Pres.			
Mar. 30	d. 20	h. 0	29.040	46.6	44.6	2.0	52.3	in.	lbs. 3.2	lbs. 1.2	SW.	SW by W.	1-10.
	22	0	048	49.6	46.9	2.7	44.8		2.5	2.8	SW by S.	WSW.	9.5
Mar. 31	0	0	058	52.2	48.3	3.9		0.069	2.2	3.0	SW by S.	WSW.	6.0
	2	0	086	51.7	48.0	3.7			1.5	2.2	SW by S.	SW by S : WSW.	5.0
	4	0	093	52.4	49.6	2.8			2.2	0.8	SW.	SW.	7.0
	6	0	094	49.5	47.3	2.2			0.8	0.0		SW by W.	10.0
	8	0	082	46.6	45.7	0.9			1.0	0.8	SW by S.	SW by S.	10.0
	10	0	102	47.5	46.2	1.3			0.5	0.5	SW by S.		8.0
	18	0	29.089	46.3	45.4	0.9			0.5	0.0		SW by S.	10.0
	20	0	29.092	47.9	46.0	1.9	56.3		0.5	0.0		SW by S.	10.0
	22	0	29.077	50.3	47.6	2.7	44.7		0.5	0.0		S.	10.0
Apr. 1	0	0	29.047	52.8	48.0	4.8		0.000	2.2	1.0	S.	S.	10.0
	2	0	28.995	53.8	51.0	2.8			2.3	2.0	S by E.	S.	10.0
	4	0	28.967	53.6	51.7	1.9			2.0	0.0		S.	10.0
	6	0	28.954	53.0	50.4	2.6			1.8	0.2	SSW.	S by W.	10.0
	8	0	28.953	49.3	48.3	1.0			0.8	0.5	SSW.	SSW.	9.9
	10	0	28.973	48.7	47.5	1.2			0.2	0.5	SW.		10.0
Apr. 2	0	0	58.4 45.7		0.0				
	18	0	29.268	45.0	44.2	0.8			0.8	0.0		W ½ N.	6.0
	20	0	338	49.0	47.0	2.0			0.2	0.8	W by S.	W : S	9.0
	22	0	380	53.9	48.9	5.0	59.3		1.0	0.5	WSW.	W.	7.0
Apr. 3	0	0	414	53.6	48.2	5.4	44.3		2.0	0.8	WSW.	W.	8.5
	2	0	443	54.0	47.6	6.4		0.330	1.0	0.5	SW by W.	W.	9.5
	4	0	419	54.8	48.5	6.3			1.0	0.8	SW by W.	WSW : WSW.	8.0
	6	0	417	50.2	45.2	5.0			1.2	0.8		WSW.	8.0
	8	0	417	41.9	40.2	1.7			0.5	0.0			5.0
	10	0	398	40.9	39.0	1.9			0.0	0.0			1.0
	18	0	29.236	40.3	38.8	1.5			0.0	0.0		SSE.	6.0
	20	0	206	44.0	43.0	1.0			0.0	0.0		SE by S : S.	9.0
	22	0	173	49.8	47.0	2.8	56.2		0.8	0.5	ESE.	ESE.	10.0 ?
Apr. 4	0	0	158	49.7	47.3	2.4	37.9		1.0	0.0		SE by E.	10.0
	2	0	137	51.2	48.6	2.6		0.000	1.2	1.2	SE.	SE by S.	10.0
	4	0	134	50.3	48.0	2.3			1.2	0.2	E.	SE.	10.0
	6	0	129	45.6	44.3	1.3			0.5	0.5	NE.	ESE.	10.0
	8	0	139	44.5	43.3	1.2			0.5	0.5	E.	ESE ?	10.0
	10	0	140	44.7	43.5	1.2			0.5	0.2	NE ?		10.0
	18	0	29.220	41.8	41.0	0.8			0.8	0.0	WSW.	WNW : NNW.	10.0
	20	0	269	43.2	41.3	1.9	51.0		0.0	0.5	WSW.		10.0
	22	0	315	47.5	44.6	2.9	41.3		0.5	1.0	NW.	WNW.	9.9
Apr. 5	0	0	361	48.6	44.2	4.4		0.308	2.8	2.0	NW.	NW by W.	10.0
	2	0	426	46.9	43.2	3.7			1.8	0.8	NW by N.	NW by W.	10.0
	4	0	454	49.8	46.3	3.5			0.8	0.8	NNW.	NW by W.	9.5
	6	0	495	48.7	45.0	3.7			0.8	0.0		WNW.	9.0
	8	0	538	44.7	40.6	4.1			0.8	0.0			0.5
	10	0	574	40.6	38.7	1.9			0.0	0.0			0.0
	18	0	29.478	38.1	37.0	1.1			0.0	0.0		SW by S.	10.0
	20	0	415	43.8	42.0	1.8	50.4		0.2	0.2	S by W.	SW.	9.0
	22	0	361	46.6	44.3	2.3	34.3		0.8	0.5	S by W.	SSW.	10.0
Apr. 6	0	0	308	49.3	47.0	2.3		0.008	1.0	0.5	SSW.	SSW.	10.0
	2	0	265	53.0	50.3	2.7			2.5	2.0	SW by W.	SW.	10.0
	4	0	236	53.1	49.4	3.7			2.0	0.8	SW.	SW.	10.0

SPECIES OF CLOUDS, &c.	Observer's Initial.
h.	
20. Scud + cumuli on NE. horizon.	W
22. Cirrous scud + linear cirri to E. lying N. and S.; clouds very thick to S.	B
0. Large masses of loose cumuli.	B
2. Loose scud: cirrous scud + linear cirri to W. pointing N. by E.; cumuli to S.	W
4. Scud.	W
6. Id.	W
8. Loose scud, very low + cirrous scud.	W
10.	B
18. Loose scud.	W
20. Id. + cirrous haze; cumulo-strati on horizon.	W
22. Patches of scud + a dense mass of cirro-stratus.	B
0. As before, but more scud.	B
2. Id. id.	B
4. Scud; dense cirro-stratus; raining.	W
6. Loose scud + loose cumuli to N. and E.	W
8. Id. + cirrous clouds.	B
10. Light rain.	B
18. Cirro-cumulous scud, the lower portion moving quickly; sky milky.	B
20. Scud: large banks of thick cirrous clouds to W.	B
22. Masses of scud and loose cumuli.	W
0. Id. + fine woolly cirri to NE. lying WNW. to ESE.; cirrous haze to SW. and S.	W
2. Loose cumuli + woolly and mottled cirri and fine cirro-cumuli mostly lying WNW. to ESE.	W
4. Masses of loose cumulo-strati: cirrous clouds of all kinds moving slowly.	B
6. Cumulo-strati to NE., patches moving across the zenith + chiefly linear and woolly cirri.	B
8. Diffuse cirri to W., woolly cirri, patches of cirro-strati to N.	W
10. Cirrous clouds and haze near horizon.	W
18. Masses of scud, moving quickly: thick patches of cirro-cumulous and cirro-stratus clouds stationary; sky [hazy.	B
20. Large detached masses of scud, very low and moving quickly: thick woolly cirri moving slowly; the cirri are of different kinds, lying in strata, in sheets, and becoming haze; the highest probably stationary.	B
22. Masses of loose cumuli to N., cirrous scud + thick mass of cirrous clouds, stationary.	W
0. Scud + cirrous haze to E.	W
2. Scud + thick mass of cirrous clouds; sky nearly covered with cirrous haze.	W
4. As before; light rain.	B
6. Low patches of scud + thick cirrous clouds, stationary.	B
8. Scud.	W
10. Raining.	W
18. Two currents of scud, the lower detached patches, the upper a thick extended mass; a few drops of rain; it has been raining heavily lately.	B
20. Nearly as before.	B
22. Scud + cirrous clouds and haze.	W
0. Masses of loose cumuli + cirrous haze.	W
2. Id. id.; less scud.	W
4. Id. id.; cirrous haze stationary.	B
6. Loose scud + large woolly cirro-cumuli, stationary; loose cumuli and cirro-strati on horizon.	B
8. Cumuli and cumulo-strati on E. horizon.	W
10. Clear.	W
18. Loose scud + woolly cirri tinged with red; cumulo-strati to E.	W
20. Scud + cirro-strati.	B
22. Id. + thick cirrous clouds; light rain.	W
0. Id.	W
2. Id.	B
4. Id. + cirrous haze; cumuli on horizon.	W

Göttingen Mean Time of Observation.			BARO- METER Corrected.	THERMOMETERS.				RAIN GAUGE.	ANEMOMETER.			Clouds moving from	Quantity of Clouds.
				Dry.	Wet.	Diff.	Max. and Min.		Pressure.		Direction of Wind.		
									Max.	Pres.			
Apr. 6	d. h. m.	in.	°	°	°	°	in.	lbs.	lbs.			0-10.	
	6 0	29.203	49.1	46.2	2.9			0.8	0.2		W by S.	10.0	
	8 0	176	46.3	44.7	1.6			0.2	0.0			10.0	
	10 5	164	45.6	43.0	2.6			0.0	0.0			10.0	
	18 0	29.141	41.6	39.8	1.8			0.8	0.0		WSW.	1.0	
	20 0	29.121	44.9	43.2	1.7			1.5	0.8	SW by W.	WSW.	7.0	
	22 0	29.094	48.3	48.0	0.3	55.1		1.2	0.5	SW.		10.0	
Apr. 7	0 0	29.049	50.2	46.0	4.2	39.3	0.000	1.0	0.5	SW by W.	SW by W.	10.0	
	2 0	29.003	52.2	48.4	3.8			1.2	0.2	SW.		10.0	
	4 0	28.978	49.9	47.5	2.4			0.2	0.0		W by S : W by S.	8.5	
	6 0	28.970	50.7	46.0	4.7			1.0	0.5	SW by W.	W by S : W by S.	9.0	
	8 0	28.976	44.8	43.6	1.2			0.5	0.0		WSW.	2.5	
	10 0	28.979	40.6	39.2	1.4			0.0	0.0			0.1	
	18 0	28.988	37.3	36.3	1.0			0.0	0.0		W by N.	5.0	
	20 0	28.977	41.2	40.5	0.7	52.3		0.2	0.0		WSW.	10.0	
	22 0	28.980	47.0	44.3	2.7	35.5		0.0	0.0		WSW.	10.0	
Apr. 8	0 0	29.010	46.0	43.7	2.3		0.144	0.2	0.2	NNE.	N by E.	10.0	
	2 0	29.063	48.1	44.0	4.1			1.2	0.8	NNE.	N by E.	6.0	
	4 0	29.165	44.5	42.0	2.5			2.0	0.8	NNE.	N by E.	10.0	
	6 0	29.268	40.7	39.6	1.1			2.2	2.2	NE.		10.0	
	8 0	29.350	40.4	37.6	2.8			2.2	0.8	NNE.	N by E.	9.9	
	10 0	29.411	37.7	34.6	3.1			1.0	0.0		NW ?	6.0	
Apr. 9	0 0	48.3		0.5					
	18 0	29.650	29.6	27.4	2.2	34.3		1.0	0.0		NNW ?	6.5	
	20 0	662	33.7	30.6	3.1			0.0	0.0			9.5	
	22 0	666	38.7	33.0	5.7	43.9		1.0	1.0	NW by N.	NW by N.	10.0	
Apr. 10	0 0	676	39.4	33.4	6.0	28.3	0.010	1.5	1.0	NW.	NW by N.	6.0	
	2 0	666	39.8	34.6	5.2			1.5	0.2	WNW.	NW by N : WNW ?	7.0	
	4 0	662	39.3	32.6	6.7			2.5	0.8	NW by N.	N by W.	6.0	
	6 0	688	35.6	32.7	2.9			2.8	0.5	N.	N by W.	9.5	
	8 0	712	34.5	31.6	2.9			0.5	0.2			2.0	
	10 0	729	33.3	29.8	3.5			0.5	0.5	NW by N.		0.5	
	18 0	29.731	29.0	26.4	2.6			1.2	1.0	NW.		0.2	
	20 0	740	34.0	30.0	4.0	42.0		1.2	1.2	NW.		0.5	
	22 0	774	36.0	32.8	3.2	27.2		2.0	0.8	NNW.	N : N.	8.0	
Apr. 11	0 0	787	39.0	34.1	4.9		0.002	1.7	1.0	N by W.	N.	8.0	
	2 0	778	41.1	34.8	6.3			1.0	0.5	NNW.	N by W : NW by W.	6.0	
	4 0	784	39.0	34.6	4.4			3.2	0.2	NW by N ?	WNW.	8.0	
	6 0	776	36.7	33.3	3.4			0.8	0.0		NW by W.	8.0	
	8 0	771	34.0	30.0	4.0			1.8	0.0			1.5	
	10 0	780	31.8	29.7	2.1			0.0	0.0		NNW.	8.0	
	18 0	29.751	27.0	26.0	1.0			0.0	0.0		NNW.	9.5	
	20 0	745	31.3	29.4	1.9	44.3		0.2	0.2	WNW.		3.0	
	22 0	722	36.4	32.2	4.2	23.8		0.8	0.8	W by S.	WNW.	9.5	
Apr. 12	0 0	670	39.9	34.4	5.5		0.000	1.2	0.8	W by S.	WNW.	9.9	
	2 0	584	45.2	39.3	5.9			3.0	3.0	W.	WNW.	9.8	
	4 0	496	44.4	38.2	6.2			5.0	3.0	W.	W by N.	10.0	
	6 0	450	37.2	36.4	0.8			5.5	3.8	WNW.		10.0	
	8 0	512	33.0	32.3	0.7			3.0	1.5	N.		10.0	
	10 0	557	33.5	31.0	2.5			2.2	0.8	N by W.	N.	7.5	
	18 0	29.663	32.6	31.4	1.2			2.5	0.5	N by W.	N by E.	3.5	

SPECIES OF CLOUDS, &c.

Observer's
Initial.

- h.
6. Thick and ragged masses of scud +- cirrous haze, &c.
8. Loose scud; thick mass of cirrous clouds; red to W.; a few drops of rain.
10. Scud.
18. A long mass of scud on S. and SE. horizon, moving slowly.
20. Masses of scud and loose cumulo-strati +- linear, woolly and reticulated cirri, with cirro-strati.
22. Scud.
0. Scud +- woolly cirri to W.
2. Homogeneous scud; light rain.
4. Scud: woolly cirri.
6. Id.: id.
8. Scud.
10. Clear; small patches of scud to N. and E.
18. Sheets of woolly cirri.
20. Scud; light rain.
22. Id.
0. Id.; raining. [woolly cirri to W.
2. Woolly cirrous scud, moving slowly +- loose cumuli to W. and S.; small detached cumuli to N. and E.;
4. Large masses of scud.
6. Rain.
8. Scud +- cirrous clouds to N.
10. Cirro-cumuluous scud; about 10^m ago it was acted on by various currents.
18. Patches of cumuli +- cumulo-strati on E. horizon; woolly cirri and cirrous haze over the sky.
20. Patches of scud; cumuli on E. horizon; cirrous haze covers the sky.
22. Scud +- thick cirrous haze.
0. Loose-edged cumuli.
2. Large masses of black scud, cumuli and nimbi, falling in snow all round: cirrous clouds.
4. Loose-edged cumuli; snow falling to N.
6. Scud +- large masses of cumuli to E. and S.; a shower of snow.
8. Cumuli and cumulo-strati on horizon, falling in showers of snow (?) to SW.
10. Cumuli to SE.
18. Clear, except a bank of cirro-stratus and loose cumuli to E.
20. Cumulo-strati on N. and E. horizon.
22. Scud, moving quickly: woolly cirri, slowly.
0. Cumuli.
2. Scud: cumuli.
4. Scud and loose cumuli +- large masses of cumuli to E.
6. Cirrous scud +- large ranges of cumuli to N. and E.; passing showers of snow.
8. Thick cumuli to NW. and on S. horizon; cirro-strati to S.
10. Scud.
18. Cirrous scud +- cumulo-strati on E. horizon. [NE.
20. Patches of cirrous scud; id.; fine linear cirri lying E. by N. to W. by S.; cirrous haze to
22. Scud to W. and NW. +- a long line of patches of cirrous-edged cumuli to SSE., feathered and assuming a
considerable likeness to the cymoid cirri; sky nearly covered with thick cirrous haze.
0. Patches of scud +- cirrous haze.
2. As before, but more scud.
4. Detached masses of scud +- dense mass of cirrous clouds and haze.
6. Rain.
8. Several heavy showers of snow since last observation.
10. Masses of scud.
18. Scud +- loose ragged cumuli on horizon.

B
W
W

B
B
W
W
W
B
B
W
W

B
B
W
W
W
W
W

W
W
B
B
B
W
W
B
B
W
W
B
W
W
W
B
B
W
W
B
W

Göttingen Mean Time of Observation.			BARO- METER Corrected.	THERMOMETERS.				RAIN GAUGE.	ANEMOMETER.			Clouds moving from	Quan- tity of Clouds.	
				Dry.	Wet.	Diff.	Max. and Min.		Pressure.		Direction of Wind.			
									Max.	Pres.				
Apr. 12	d. 20	h. 0	m. 0	29.699	34.0	32.0	2.0	46.3	in.	lbs.	lbs.	N by W.	N by E.	0-10.
				742	36.1	32.2	3.9	28.8		1.5	1.0	NNW.	N : N by E.	7.0
Apr. 13	0	0	0	758	39.9	34.9	5.0		0.114	2.0	0.8	N.	N by W : N.	3.5
	2	0	0	763	40.0	34.1	5.9			1.8	1.2	N by W ?	NNW.	5.5
	4	0	0	745	40.1	34.7	5.4			1.5	0.5	NW by N ?	WNW.	8.5
	6	0	0	719	38.5	32.8	5.7			0.5	0.2		WNW.	10.0
										0.2	0.0		WNW ?	10.0
	8	0	0	697	35.9	33.2	2.7			0.5	0.0	W.	W.	10.0
	10	0	0	657	35.0	32.8	2.2			0.5	0.2	W by S ?		10.0
	18	0	0	29.323	47.0	44.6	2.4			3.5	2.5	WSW.	W.	9.9
	20	0	0	332	48.1	45.8	2.3	39.6		2.5	1.5	W by S.	W by N : NW.	10.0
	22	0	0	341	51.5	47.7	3.8	33.3		4.0	3.5	W by S.	WNW.	9.7
Apr. 14	0	0	0	383	56.0	50.5	5.5		0.053	3.2	3.8	W by S.		9.5
	2	0	0	444	55.9	48.3	7.6			3.8	2.0	W by S.	WNW : WNW.	8.0
	4	0	0	489	57.6	49.6	8.0			2.2	1.2	NW by W.	NW by N.	7.5
	6	0	0	537	53.0	48.0	5.0			1.2	1.2	W by N.	NW.	9.7
	8	0	0	591	50.1	46.8	3.3			1.5	0.0		NW : WNW.	10.0
	10	0	0	625	49.8	47.0	2.8			2.0	0.8	W by S.		10.0
	18	0	0	29.725	46.8	44.6	2.2			1.2	0.2	SW by W ?	W.	10.0
	20	0	0	743	48.4	45.8	2.6	57.3		0.5	0.5	SW by S.	W.	9.0
	22	0	0	756	51.4	47.9	3.5	45.6		0.8	0.8	WSW.	WSW ?	9.0
Apr. 15	0	0	0	778	53.0	49.2	3.8		0.000	2.0	2.0	SW by W.	WSW : W by N.	7.0
	2	0	0	776	53.0	49.0	4.0			1.2	1.5	SW.	WSW.	9.9
	4	0	0	768	52.9	47.3	5.6			1.2	0.8	SW.	WSW.	8.0
	6	0	0	760	49.0	45.0	4.0			1.0	0.8	SW.	WSW.	9.9
	8	0	0	764	46.4	43.5	2.9			0.8	0.5		WSW.	9.5
	10	0	0	759	45.0	43.0	2.0			0.5	0.0			10.0
Apr. 16	0	0	0	55.4 43.7		0.8				
	18	0	0	29.738	42.7	42.0	0.7			0.5	0.0		W ?	10.0
	20	0	0	749	50.2	48.0	2.2			0.0	0.0			7.0
	22	0	0	781	54.8	50.1	4.7	57.3		0.0	0.0		S ? : SSE.	9.9
Apr. 17	0	0	0	785	58.7	52.0	6.7	41.6		0.0	0.0		SSE.	9.9
	2	0	0	783	58.0	50.5	7.5		0.000	0.0	0.0		SE.	9.7
	4	0	0	786	60.1	52.7	7.4			0.0	0.0		S.	9.0
	6	0	0	787	56.8	49.1	7.7			0.0	0.0			1.8
	8	0	0	804	48.5	46.2	2.3			0.2	0.0		SSW.	3.0
	10	0	0	822	47.0	45.0	2.0			0.0	0.0		SSW.	3.5
	18	0	0	29.826	40.0	39.3	0.7			0.0	0.0		SW by W.	8.0
	20	0	0	824	44.8	42.9	1.9	62.6		0.0	0.0		WSW.	10.0
	22	0	0	814	55.0	50.6	4.4	39.6		0.2	0.0		SSW.	10.0
Apr. 18	0	0	0	813	54.3	48.0	6.3		0.000	1.2	1.2	SW by W.	SSW.	10.0
	2	0	0	782	55.3	50.0	5.3			2.0	1.0	SW.	SW by S.	8.5
	4	0	0	769	52.0	48.3	3.7			2.0	0.8	WSW.	SW by S.	10.0
	6	0	0	761	51.0	48.6	2.4			1.5	0.5	SW.	SW by S.	10.0
	8	0	0	747	50.8	48.6	2.2			0.8	0.2	WSW.	SW by W.	9.7
	10	0	0	753	49.5	47.5	2.0			1.5	1.2	SW.		6.0
	18	0	0	29.719	47.8	47.1	0.7			1.0	0.2	SW.	SW.	9.5
	20	0	0	720	51.1	47.8	3.3			1.0	0.5	SW.	SW : SW.	9.0
	22	0	0	721	57.2	52.4	4.8	58.4		0.8	0.0		SW.	9.7
Apr. 19	0	0	0	703	60.8	54.0	6.8	46.7	0.000	0.5	0.5	SW.	NW : S by W.	8.0

SPECIES OF CLOUDS, &c.

Observer's
Initial.

h.		
20.	Cirrous scud + thick scud to E.; cirrous clouds to W.; occasional showers of snow.	W
22.	Two currents of cirrous scud.	B
0.	Id.	B
2.	Loose-edged cumuli + linear and curled cirri radiating from N.; sky to W., covered with cirrous haze.	B
4.	Loose cumuli.	W
6.	Masses of cirrous scud + thick cirrous haze over the sky; half of a solar halo seen, radius about 23°; the space within the halo is much darker than without it, being dark gray; the edge of the halo is brownish and passes into the bluish-white of the cirrous haze without.	W
8.	Scud + cirrous haze over the sky.	B
10.	Dense cirro-stratus; a few drops of rain.	B
18.	Scud + cirro-strati to NE. lying SSE. to NNW.	W
20.	Loose scud, quickly: thick cirrous clouds and haze covering all the sky + cumulo-strati on NE. horizon.	W
22.	Detached masses of scud on horizon + thick linear cirri over the sky, generally becoming haze, radiating from NW.; cirro-cumuli to S.	B
0.	Nearly as before; the cirri radiating more distinctly than before, and from WNW., intersected at right angles near the zenith by fine lines of cirri.	B
2.	Detached masses of cumuli and scud round horizon: long strips of flame-like cirri rising from woolly cirri, pointing from WNW.; sheets of cirri to SW. appear superimposed upon each other.	B
4.	Cirrous clouds; rather large cirro-cumuli lying in rows towards SSE. with sheets of woolly cirri interspersed.	W
6.	Thick cirrous clouds; cirro-cumuli to W.; cirro-strati and linear cirri to E. lying NNW. to SSE.; patches of scud on N. and S. horizon.	W
8.	Scud: cirro-cumuli, in sheets radiating from NW.; the sky very stormy like.	B
10.	Nearly as before.	B
18.	Scud + masses of loose cumuli on SE. horizon; cirro-strati on E. horizon.	W
20.	Id. + large woolly cirro-cumuli; cirro-strati and cumulo-strati to E.	W
22.	Thick scud + cirro-cumuli and sheets of cirri.	B
0.	Scud, moving quickly: cirro-cumuli, woolly cirri, &c., slowly.	B
2.	Scud.	B
4.	Scud + linear cirri, pointing from WNW.	W
6.	Id.	W
8.	Id. + cirro-cumuli; clouds red to W.	B
10.	Id.	B
18.	Thick cirro-cumuluous scud, the patches of various colours; motion very small.	B
20.	As before.	B
22.	Patches of scud and loose cumuli on horizon: cirro-cumuluous scud.	W
0.	Loose cumuli, motion scarcely perceptible.	W
2.	Cirrous scud, moving very slowly + loose cumuli near horizon.	W
4.	Cumuli and cirrous scud.	B
6.	Cirro-cumuluous scud (as throughout the day); masses of cumuli on horizon to SE.	B
8.	Cirro-cumuluous scud.	W
10.	Id.	W
18.	Id., lying in strata to N. + cirrous haze and rippled cirri.	B
20.	Id.	B
22.	Scud + haze.	W
0.	Detached masses of scud + patches of cirrous clouds to W.; sky nearly covered with cirrous haze.	W
2.	Scud + woolly cirri and cirrous haze.	W
4.	Id. + cirrous clouds and haze.	W
6.	Id. + cumulo-strati on E. and NE. horizon.	W
8.	Loose scud, very low, moving quickly + masses of cirrous clouds; cirro-strati to NW.	W
10.	Scud.	W
18.	Scud + irregular cirro-cumuli.	B
20.	Id., low and moving quickly: large loose cirro-cumuli, slowly + finer cirro-cumuli and linear cirri.	B
22.	Scud + cirrous clouds, principally large cirro-cumuli with fine linear and woolly cirri; cumulo-strati to E.	W
0.	Loose-edged cumuli in two currents + cumulo-strati on horizon; fine linear and woolly cirri and cirrous haze. In a short time the great mass of the scud and cumuli are from W. by S.: sea-gulls flying very high.	W

Göttingen Mean Time of Observation.			BARO- METER Corrected.	THERMOMETERS.				RAIN GAUGE.	ANEMOMETER.			Clouds moving from	Quan- tity of Clouds.
				Dry.	Wet.	Diff.	Max. and Min.		Pressure.		Direction of Wind.		
									Max.	Pres.			
Apr. 19	d. h. m.	in.	°	°	°	°	in.	lbs.	lbs.			0-10.	
	2 0	29.673	61.6	52.4	9.2			0.2	0.0		S by W.	10.0	
	4 0	648	61.3	51.3	10.0			0.0	0.0		S by W : ESE.	9.0	
	6 0	625	57.7	51.8	5.9			0.2	0.0			8.5	
	8 0	626	53.7	50.1	3.6			0.0	0.0		S by W.	8.5	
	10 0	623	49.0	46.7	2.3			0.0	0.0			3.0	
	18 0	29.557	36.3	36.0	0.3			0.0	0.0		SW.	6.0	
	20 0	547	44.0	42.2	1.8			0.0	0.0		S ?	9.5	
	22 0	530	53.3	47.0	6.3	64.4		0.5	0.5	ENE.		9.0	
Apr. 20	0 0	509	55.8	49.0	6.8	35.6	0.000	0.8	0.2	E by N.	SE by S.	9.9	
	2 0	484	55.0	50.0	5.0			0.2	0.2	E by S.	SE by S.	10.0	
	4 0	467	52.8	48.1	4.7			0.5	0.0		SW.	10.0	
	6 0	468	51.3	47.5	3.8			0.2	0.0		SSW.	9.7	
	8 0	482	49.4	46.9	2.5			0.0	0.0		SSW ?	10.0	
	10 0	500	50.0	47.7	2.3			0.0	0.0			8.5	
	18 0				
	20 0	57.3					
	22 0	29.572	54.2	50.9	3.3	42.7		0.5	0.5	SW.	SW by W.	9.0	
Apr. 21	0 0	574	55.7	50.3	5.4		0.000	0.5	0.0		SW.	9.9	
	2 0	576	58.0	51.6	6.4			0.5	0.2	SW.	S.	9.9	
	4 0	565	57.0	50.0	7.0			0.5	0.5	SW.	S by W.	6.0	
	6 0	559	55.4	49.5	5.9			0.5	0.0		SSW ?	9.9	
	8 0	561	52.0	49.0	3.0			0.0	0.0		S ?	10.0	
	10 0	556	49.1	46.9	2.2			0.0	0.0			10.0	
	18 0	29.491	47.7	46.3	1.4			0.2	0.2	SE.		10.0	
	20 0	498	48.7	47.4	1.3			0.2	0.2	SE.	S by E.	10.0	
	22 0	519	50.2	48.0	2.2	58.3		0.5	0.0		S by E.	10.0	
Apr. 22	0 7	527	50.0	48.8	1.2	45.7	0.172	0.0	0.0		S by E.	10.0	
	2 0	529	51.0	48.9	2.1			0.0	0.0		SW ? : SE.	10.0	
	4 0	548	49.3	47.6	1.7			0.2	0.0		SE ?	10.0	
	6 0	573	49.0	47.3	1.7			0.0	0.0		NW by N : SSE.	10.0	
	8 0	603	46.8	46.3	0.5			0.0	0.0			10.0	
	10 0	621	45.0	43.8	1.2			0.0	0.0			10.0	
Apr. 23	0 0	52.2	0.468	0.0					
	18 7	29.816	35.3	34.3	1.0	40.9		1.5	...		S by E.	5.0	
	20 0	836	39.5	38.2	1.3			0.0	0.0			0.5	
	22 0	830	50.0	45.3	4.7	49.4		0.8	0.8	S by E.	SSE.	2.0	
Apr. 24	0 0	813	53.9	47.0	6.9	31.4	0.067	1.5	1.0	S.	S by W.	3.5	
	2 0	787	56.4	48.6	7.8			2.2	2.0	S.	S by W.	7.0	
	4 0	752	55.8	47.9	7.9			2.0	1.0	S by E.	S by W.	8.0	
	6 0	740	51.6	46.7	4.9			1.0	0.8	S.	S by W.	10.0	
	8 0	727	47.8	44.1	3.7			1.5	0.8	S.	S by W.	10.0	
	10 0	684	46.7	43.3	3.4			3.0	1.8	S by E.		10.0	
	18 0	29.327	43.0	41.0	2.0			3.8	4.0	S.	S.	10.0	
	20 0	263	41.2	40.0	1.2			3.2	3.0	S.	S.	10.0	
	22 0	211	40.8	39.2	1.6	57.3		4.8	2.2	S.	SSW : SW ?	10.0	
Apr. 25	0 0	180	44.0	42.4	1.6	39.9	0.127	3.0	1.0		SW.	10.0	
	2 0	175	50.8	46.4	4.4			1.0	1.5	NW by W.	W : S by E.	8.0	
	4 0	177	51.6	46.0	5.6			1.8	1.0	WNW.	NW.	8.5	
	6 0	201	50.0	44.0	6.0			1.8	1.2	NW.	NW.	8.0	
	8 0	224	45.3	40.8	4.5			1.2	0.2	WSW ?		4.0	
	10 0	234	41.4	38.0	3.4			0.8	0.5	WSW.		3.0	
	18 0	29.229	37.0	35.0	2.0			0.5	0.0		NNW ?	2.0	

SPECIES OF CLOUDS, &c.

Observer's
Initial.

h.		
2.	Scud and loose cumuli +- cumuli and cumulo-strati on horizon ; a few drops of rain.	B
4.	Scud and loose cumuli : cumuli +- hazy on E. horizon.	B
6.	Nearly as before.	B
8.	Scud and loose cumuli ; thin fog ; sky red to W.	W
10.	Scud.	W
18.	Loose cirro-cumuli and woolly cirri ; thick fog.	B
20.	Cirrous clouds, woolly cirri, &c.	B
22.	Sky covered with cirrous clouds and haze ; cumulo-strati and cirro-strati.	W
0.	Scud +- cirrous clouds ; cumulo-strati to S. ; a few drops of rain.	W
2.	Id. +- thick mass of cirrous clouds ; ranges of cumulo-strati to SE. and S.	W
4.	Id. +- cirro-stratus to E. ; cirrous clouds to NE.	H
6.	Id. +- large cirro-cumuli.	W
8.	Id.	W
10.	Id.	W
18.		
20.		
22.	Id. +- woolly cirri ; ranges of cumuli to S. and E.	W
0.	Scud and loose cumuli ; sky to E.	W
2.	Id. ; id. ; cirrous clouds and haze.	W
4.	Loose cumuli +- woolly, mottled and curled cirri and cirrous haze.	W
6.	Cirro-cumulous scud +- cirrous clouds.	W
8.	Id., motion scarcely perceptible +- cirro-strati to NE. lying SSE. to NNW.	W
10.	Scud ; dark.	W
18.	Sky very milky ; some patches of scud ; thick cirrous haze ; light rain.	W
20.	Scud ; light rain.	W
22.	Id. ; id.	B
0.	Id. ; id.	B
2.	Id., moving very slowly ; a dark mass of scud rising like a curtain from SW. ; heavy rain immediately.	W
4.	Cirro-cumulous scud +- loose scud on horizon ; a few drops of rain.	W
6.	Patches of scud : scud ; light rain.	W
8.	Raining since last observation.	W
10.	Scud.	W
	*	
18.	Scud ; hoar-frost.	W
20.	Masses of scud to SW.	W
22.	Loose-edged cumuli +- cumulo-strati on horizon.	B
0.	Cumuli and cumulo-strati.	B
2.	Id.	W
4.	Cumuli, scud, &c.	B
6.	Id., id. ; a few heavy drops of rain lately from a dark mass of clouds.	W
8.	Scud and loose cumuli +- cirrous haze.	W
10.	Homogeneous.	W
18.	Loose scud, moving quickly +- thick cirrous haze above ; light rain.	W
20.	Scud ; rain.	W
22.	Two currents of scud +- cirrous haze ; light rain.	B
0.	Scud.	B
2.	Scud and loose cumuli : woolly cirri ; smart hail shower lately.	B
4.	Id. +- cirrous clouds and haze above.	W
6.	Thin scud +- woolly and curled cirri ; cumulo-strati on horizon. [red to WNW.	W
8.	Cirrous clouds, principally woolly and diffuse cirri, becoming haze ; masses of cumuli to E. in haze ; clouds	W
10.	Masses of cirrous clouds, lying NNW. to SSE. ; thick cirrous haze to E.	W
18.	Masses of cirrous scud +- woolly cirri ; thick mass of cirrous clouds and haze on E. horizon.	W

Göttingen Mean Time of Observation.			BARO- METER Corrected.	THERMOMETERS.				RAIN GAUGE.	ANEMOMETER.			Clouds moving from	Quan- tity of Clouds.
				Dry.	Wet.	Diff.	Max. and Min.		Pressure.		Direction of Wind.		
									Max.	Pres.			
Apr. 25	d. h. m.		in.	°	°	°	°	in.	lbs.	lbs.			0-10.
	20	0	29.250	39.9	37.0	2.9	51.8		0.8	0.5	W.	W.	1.3
	22	0	259	44.2	39.2	5.0	35.7		0.8	0.2	W.	WNW.	5.5
Apr. 26	0	0	262	47.2	41.6	5.6		0.012	0.5	0.8	W.	WSW.	7.5
	2	0	264	43.8	39.0	4.8			0.5	0.2	W.	SSW.	10.0
	4	0	274	44.0	40.4	3.6			0.2	0.0		SE ?	9.9
	6	0	315	40.8	38.6	2.2			0.8	0.8	NE.	NE by E.	10.0
	8	0	377	40.2	38.2	2.0			0.8	0.0		NNE.	8.8
	10	0	443	37.0	35.5	1.5			0.0	0.0			1.5
	18	0	29.613	34.3	33.3	1.0			0.0	0.0			0.2
	20	0	644	38.0	36.3	1.7			0.0	0.0			0.5
	22	0	646	47.0	44.0	3.0	50.1		0.0	0.0	SSW.	S.	8.0
Apr. 27	0	0	646	51.1	45.4	5.6	32.5		0.5	0.8	S by E.	S.	9.8
	2	0	615	55.0	48.2	6.8		0.015	1.2	1.0		S.	10.0
	4	0	581	54.7	47.3	7.4			2.2	1.1	SSW.	S.	8.5
	6	0	551	53.9	47.0	6.9			1.8	1.3	SSW.	S.	6.0
	8	0	541	48.9	45.0	3.9			1.1	0.6	SSW.	S ?	10.0
	10	0	533	45.9	43.3	2.6			0.9	0.1	S.		10.0
	18	0	29.392	43.8	41.5	2.3			1.8	0.7	S.	SSW.	10.0
	20	0	375	44.8	42.1	2.7			1.5	0.7	S by E.	SSW.	10.0
	22	0	368	46.0	43.7	2.3	57.2		1.8	0.8	S by E.	S by W.	10.0
Apr. 28	0	0	354	46.8	44.8	2.0	43.2		1.3	0.9	S by E.	S by W.	10.0
	2	0	353	46.8	45.2	1.6		0.104	1.3	0.5	SSW.	S by W.	10.0
	4	0	353	44.3	43.4	0.9			0.7	0.0		S by W.	10.0
	6	0	356	44.6	43.1	1.5			0.0	0.0		SSW.	8.5
	8	0	382	42.6	41.7	0.9			0.0	0.0			0.5
	10	0	409	41.6	40.6	1.0			0.0	0.0		W.	1.5
	18	0	29.458	34.6	34.2	0.4			0.2	0.0			9.7
	20	0	488	42.1	41.3	0.8			0.0	0.0		W ?	6.5
	22	0	517	48.0	45.9	2.1	49.7		0.0	0.0		S by E.	5.5
Apr. 29	0	0	534	51.3	46.8	4.5	33.4		0.1	0.0		E by N.	8.0
	2	0	565	53.2	47.8	5.4		0.297	0.5	0.5	NE.	NNE.	9.8
	4	0	579	52.0	46.6	5.4			0.7	0.5	NE by E.		8.0
	6	0	615	47.2	44.8	2.4			0.5	0.5	NE.	NNE : E by S.	10.0
	8	0	676	45.0	44.0	1.0			0.4	0.1	ENE ?		10.0
	10	0	741	44.3	44.0	0.3			0.4	0.0			10.0
Apr. 30	0	0	54.0		1.0				
	18	0	30.186	34.8	34.4	0.4	42.3		0.000			ENE ?	2.0
	20	0	195	44.0	42.9	1.1			1.5	0.0		E.	7.0
	22	0	193	52.9	49.5	3.4	56.1		0.0	0.0			2.5
May 1	0	0	200	57.0	50.0	7.0	32.0		0.7	0.7	ENE.	ENE.	3.0
	2	0	193	60.0	50.7	9.3		0.000	0.7	0.7	ENE.		1.0
	4	0	174	58.6	50.0	8.6			0.8	0.7	NE by N.		0.3
	6	0	161	56.0	49.0	7.0			0.8	0.5	NE by N.	E ?	4.0
	8	0	173	51.2	47.7	3.5			0.5	0.0			2.0
	10	0	179	45.3	44.2	1.1			0.0	0.0			0.2
	18	0	30.153	36.7	36.0	0.7			0.0	0.0			1.0
	20	0	141	41.8	40.2	1.6			0.0	0.0		ENE ?	5.0
	22	0	128	49.7	45.0	4.7	60.5		0.0	0.0			3.5
May 2	0	0	091	52.8	47.8	5.0	35.3		0.4	0.4	ENE.		2.0
	2	0	059	52.6	48.7	3.9		0.000	0.6	0.5	E by N.	NE ?	3.0

SPECIES OF CLOUDS, &c.	Observer's Initial.
h.	
20. Patches of cirrous scud + cirrous clouds and haze on E. horizon; cumuli on S. and SE. horizon.	W
22. Cirrous-edged cumuli and cumulo-strati.	B
0. Many cumuli + nimbi to E. and SE.	F
2. Scud and loose-edged cumuli; a smart shower of hail lately.	W
4. Scud + cumuli near horizon; woolly cirri to SE.; most of the sky covered with a thick milky haze.	W
6. Scud + thick cirrous haze; cumuli near horizon; light rain.	W
8. Id. + id.; sky to NW.	B
10. Scud?	B
18. Clear; cirro-strati on S. and E. horizon.	W
20. Cirro-cumulous scud to E. Thermometer in the sun 77°.	W
22. Loose-edged cumuli.	B
0. Id.	B
2. Id.	B
4. Loose cumuli + cirrous clouds to W. [on horizon.	W
6. Scud and loose-edged cumuli + mottled cirri and cirro-cumuli to W.; cumulo-strati to E. and SE.; haze	W
8. Cirro-cumulous scud + cirrous haze; sky stormy-like.	B
10. Nearly as at 8 ^h , more scud.	B
18. Scud + sky covered with a thick milky mass of clouds; a few drops of rain.	W
20. Id. + thick cirrous haze above.	W
22. Id.; light rain.	B
0. Id.; id.	B
2. Id.; id.	B
4. Id.; id.	W
6. Scud and loose cumuli + patches of cirri to S.; cirro-strati to NE.	W
8. Cirro-strati, cirro-cumuli, and mottled cirri.	B
10. Cirro-cumulous scud, with which the sky was suddenly covered about half an hour ago.	B
18. Masses of mottled and diffuse cirri and cirro-cumuli; thick mass of cirro-strati and haze near the horizon. A parhelion to the S. of the sun; it is of about the same size, and at the same altitude as the sun, but soon becomes elongated like a portion of a halo; the side nearest the sun is orange and the other greenish-yellow.	W
20. Patches of scud, moving along N. and S. horizon + woolly and diffuse cirri and cirrous haze.	W
22. Many cirro-cumuli to E. + masses of scud, twisting and moving in all directions; linear cirri to W.; cumuli and cumulo-strati on N. and S. horizon.	B
0. Scud and cumuli + linear and reticulated cirri, becoming cirrous haze.	B
2. Patches of loose cumuli and scud + sky covered with cirrous haze; the cirri at 1 ^h were cymoid and moved from S.	B
4. Mottled cirri and cirro-cumuli, cirrous haze; scud moving along E. horizon.	W
6. Two currents of scud + cirro-cumuli.	W
8. A dense mass of cirro-stratus and haze.	B
10. Scotch mist.	B
18. Linear and mottled cirri; thick fog; much hoar-frost.	B
20. Woolly, mottled, woven and curled cirri pointing from E.	B
22. Woolly and reticulated cirri, linear cirri to E. and N.; masses of fleecy cirrous clouds to W.; cirrous haze near horizon.	W
0. Thin woolly and striated cirri, lying from ENE. to SSW.; thick cirrous haze to N. and E.	W
2. Woolly and curled cirri; a band of curled cirri stretching across the sky from E. by N. to W. by S.; cirrous haze on N. and E. horizon.	W
4. Cirrous haze near horizon; patches of woolly cirri.	W
6. Cirri, scattered over the sky in all directions.	B
8. Woolly and reticulated cirri; cirrous haze on horizon.	W
10. Clear; a streak of cirro-stratus to N.	W
18. Woolly and woven cirri to ESE.; thick fog rising from the hollows; heavy dew.	B
20. Long lines of flame-like cirri like long feathers; the flame-like cirri rising from a midrib which points from ESE., the cirri pointing from NNE.	B
22. Chiefly woolly and striated cirri; sheets of woolly cirri to W. and S., near horizon.	W
0. Beautiful flame-like cirri.	W
2. Flame-like cirri, more curled, woolly cirri; scud and haze on E. horizon.	W

Göttingen Mean Time of Observation.			BARO- METER Corrected.	THERMOMETERS.				RAIN GAUGE.	ANEMOMETER.			Clouds moving from	Quan- tity of Clouds.
				Dry.	Wet.	Diff.	Max. and Min.		Pressure.		Direction of Wind.		
									Max.	Pres.			
May	2	4 0	30.018	52.0	48.0	4.0	°	in.	lbs.	lbs.			0-10.
		6 0	29.998	47.8	45.6	2.2			0.5	0.4	NE by E.		2.0
		8 0	29.979	42.0	41.2	0.8			0.4	0.4	ENE.		1.5
		10 0	29.970	40.6	40.0	0.6			0.5	0.5	ENE.	NE ?	10.0
		18 0	29.831	40.0	39.4	0.6			0.5	0.0			10.0
		20 0	801	41.2	40.3	0.9	54.3		0.0	0.0			10.0
		22 0	774	46.7	44.6	2.1	38.3		0.0	0.0		S by W ? : NE.	6.5
May	3	0 0	728	52.1	48.8	3.3		0.000	0.0	0.0			0.2
		2 0	694	57.1	51.1	6.0			0.2	0.1	NE.		0.3
		4 0	643	57.1	50.8	6.3			0.5	0.5	NE by N.		0.3
		6 0	607	56.8	51.2	5.6			0.3	0.1	NE.		0.3
		8 0	587	51.0	47.8	3.2			0.2	0.0			0.3
		10 0	570	44.7	43.7	1.0			0.2	0.0			0.3
		18 0	29.475	41.8	40.5	1.3			0.0	0.0			0.5
		20 0	457	48.8	46.3	2.5			0.0	0.0			0.3
		22 0	428	56.2	49.7	6.5	58.3		0.6	0.6	SSW.	S by E.	5.5
May	4	0 0	423	57.7	49.3	8.4	38.5	0.000	0.7	0.5	SW by S.	S.	8.5
		2 0	385	61.6	52.0	9.6			0.8	1.0	SW by S.	S by W.	6.5
		4 0	361	58.8	51.0	7.8			0.7	0.9	S by W.	S by W.	9.9
		6 0	344	54.0	49.3	4.7			0.8	0.0		S.	7.0
		8 0	312	50.1	47.7	2.4			0.4	0.0		S.	10.0
		10 0	280	49.2	47.7	1.5			0.0	0.0			10.0
		18 0	29.270	38.4	37.0	1.4			1.7	1.3	SW by S.	SW.	2.0
		20 0	294	43.0	40.3	2.7			0.6	0.4	SSW.	SSW : SW by S.	3.5
		22 0	294	49.9	45.0	4.9	61.7		2.0	1.1	SSW.	SSW.	6.0
May	5	0 0	291	50.0	44.7	5.3	38.9	0.064	2.5	1.0	S.	SSW.	9.0
		2 0	304	46.7	42.9	3.8			4.8	2.5	S.	SSW.	9.5
		4 0	266	50.8	45.3	5.5			4.3	1.7	SSW.	SSW.	4.0
		6 0	246	51.9	43.2	8.7			4.3	3.8	S.	SSW.	3.0
		8 0	257	45.7	40.3	5.4			3.0	1.1	S by W.	SSW.	5.0
		10 0	236	44.0	39.9	4.1			2.9	1.3	S.	SSW.	4.0
		18 0	29.328	41.0	39.1	1.9			2.8	0.2	SSW.	SSW.	3.5
		20 0	331	45.3	42.0	3.3			0.4	0.4	SSW.	SSW : SSW.	7.5
		22 0	322	46.9	42.7	4.2	53.3		0.6	0.6	SSW.	WSW : S.	7.0
May	6	0 0	314	52.0	46.7	5.3	38.9	0.111	0.3	0.0		WSW.	10.0
		2 0	276	53.8	46.7	7.1			0.0	0.0			10.0
		4 0	244	53.7	47.0	6.7			0.0	0.0		W by N.	10.0
		6 0	246	48.0	44.0	4.0			0.7	0.1	E ?	WNW.	10.0
		8 0	229	45.0	42.0	3.0			0.0	0.0		WNW.	10.0
		10 0	208	43.8	42.2	1.6			0.0	0.0			10.0
May	7	0 0	55.5		0.8				
		18 0	29.517	41.7	41.0	0.7	40.6		2.6	0.0		E by S.	10.0
		20 0	541	45.1	43.7	1.4			0.2	0.2	ENE.	ESE.	9.0
		22 0	556	48.2	45.0	3.2			0.5	0.7	E.	E.	9.7
May	8	0 0	578	49.3	46.0	3.3		0.294	1.4	1.1	E by S.	E by S.	10.0
		2 0	620	46.7	42.6	4.1			1.6	1.2	E by S.	E by S.	9.9
		4 0	626	48.3	43.3	5.0			1.3	1.4	ENE.	E by S.	9.0
		6 0	545	48.7	44.0	4.7			1.7	1.3	ENE.	E.	8.0
		8 0	665	45.0	42.0	3.0			1.0	0.3	ENE.	ENE.	10.0
		10 0	670	44.0	42.0	2.0			0.2	0.2	NNE ?		10.0
		18 0	29.674	45.3	42.5	2.8			0.7	0.1	NE ?		8.0

SPECIES OF CLOUDS, &c.	Observer's Initial.
h.	
4. Flame and mottled cirri to W. ; a bank of scud and haze on E. horizon.	W
6. Flame-like and woolly cirri and cirro-strati to W. ; scud and haze on E. horizon.	B
8. Scud, homogeneous.	W
10. Id., id.	W
18. Thick fog.	B
20. Fog clearing off.	B
22. Two currents of scud.	W
0. Patches of loose cumuli on S. horizon ; haze on E. horizon.	W
2. Detached masses of scud and loose cumuli on N. and S. horizon ; masses of mottled cirri to W.	W
4. Cumulo-stratus to S. and a thick sheet of cirro-cumuli to SW.	B
6. Id. id.	W
8. Id. ; patches of cirri to SSW.	W
10. Patches of cirrous clouds to W. ; haze and clouds on S. and SE. horizon.	W
18. Very thin cirrous haze, principally on E. horizon.	B
20. Cirro-strati to E.	W
22. Cirrous clouds, chiefly cirro-cumuli + cirrous haze to S. and E. ; cumuli on N. horizon.	W
0. Woolly cirri and cirro-cumuli + cirrous haze ; ranges of cumuli on N. horizon.	W
2. Scud and loose-edged cumuli + masses of cirrous clouds and haze.	B
4. Masses of cumuli in haze ; sky stormy-like.	W
6. Scud and loose cumuli ; a few drops of rain.	W
8. Id.	W
10. Scud.	W
18. Masses of scud, moving quickly + cumulo-strati on NE. horizon. Thunder heard last night and this morning.	B
20. Thin scud : thicker scud, moving slower ; a few drops of rain.	B
22. Scud and cumuli + cumulo-strati on horizon.	W
0. Id. + id.	W
2. Scud + cumuli near horizon ; drops of rain.	W
4. Cumuli, cumulo-strati and nimbi + cirrous haze to E. ; passing showers.	B
6. Scud, cumuli and cumulo-strati.	B
8. Scud and loose cumuli + cirro-strati and cirrous haze.	W
10. Scud.	W
18. Strata of scud and linear and woolly cirri.	B
20. Strata of scud to E. : thick and large masses of woolly cirri, becoming flame-like.	B
22. Scud and loose cumuli : cirrous clouds, chiefly cirro-cumuli, woolly cirri.	W
0. Detached masses of scud + thick cirro-stratus and haze.	W
2. Id. ; id.	W
4. Scud + id.	B
6. Id. + id.	B
8. Id. + id.	W
10. Light rain.	W
18. Scud + dense cirrous clouds ; cumuli on horizon ; rain till now.	W
20. Id. + mottled and reticulated cirri and cirro-cumuli. like.	W
22. Scud and loose cumuli, moving quickly + pyramidal and common cumuli, moving very slowly ; sky stormy-	B
0. Scud and loose cumuli.	B
2. Id.	B
4. Loose cumuli + large cirro-cumuli and woolly cirri.	W
6. Scud and loose cumuli + cirrous clouds and haze.	W
8. Scud rising from E. + thick sheet of cirro-stratus ; long blue bank of cirro-stratus to E.	B
10. Nearly as before ; cirri ribbed, ribs lying N. and S. ; less even surface of clouds.	B
18. Cirrous clouds ; large cirro-cumuli and mottled cirri ; cirrous haze ; very thick to W. ; cirro-strati to NE. ; bank of scud to SE.	W

Göttingen Mean Time of Observation.			BARO- METER Corrected.	THERMOMETERS.				RAIN GAUGE.	ANEMOMETER.		Clouds moving from	Quan- tity of Clouds.	
				Dry.	Wet.	Diff.	Max. and Min.		Pressure.				Direction of Wind.
									Max.	Pres.			
May	d. h. m.		in.	°	°	°	°	in.	lbs.	lbs.		0-10.	
8	20	0	29.704	48.0	44.8	3.2	50.1		1.0	0.7	NE.	NE : E by S.	8.0
	22	0	731	51.4	47.8	3.6	50.1		0.8	0.6	NE.	NE : E by S.	8.5
May	9	0	749	49.5	46.5	3.0	42.4	0.002	1.4	1.2	NE?	NE : O.	8.0
	2	0	763	51.3	47.5	3.8			1.2	1.0	ENE.	E : NE by E.	7.0
	4	0	782	49.7	46.2	3.5			1.2	0.5	NE.	NE by E.	9.9
	6	0	791	50.0	46.3	3.7			0.7	0.6	NE.	NE?	0.5
	8	0	823	47.2	45.0	2.2			0.5	0.4	NE.		0.3
	10	0	853	43.8	43.0	0.8			0.4	0.1	NE.	ENE.	7.0
	18	7	29.939	42.8	40.8	2.0			0.2	0.0		NE.	10.0
	20	0	29.961	44.2	41.7	2.5	51.9		0.2	0.1	NE by E.	NE.	9.5
	22	0	29.986	48.0	45.0	3.0	39.7		0.5	0.4	NE by E.	NE.	7.5
May	10	0	29.998	48.0	44.3	3.7		0.000	0.6	0.5	NE by E.	E.	6.0
	2	0	30.006	48.4	45.0	3.4			0.7	0.4	NE.	ENE.	5.0
	4	0	30.005	49.1	45.2	3.9			0.7	0.5	NE by E.		0.3
	6	0	30.003	48.1	44.7	3.4			0.9	0.6	NE by E.		0.2
	8	0	30.020	45.6	42.8	2.8			0.6	0.2	NE.		0.2
	10	0	30.035	39.2	38.8	0.4			0.2	0.0			0.0
	18	0	30.035	37.9	37.6	0.3			0.0	0.0			10.0
	20	0	30.032	40.7	40.3	0.4	49.2		0.0	0.0			10.0
	22	0	30.017	45.0	43.0	2.0	36.0		0.0	0.0		NNW.	4.0
May	11	0	29.989	50.7	46.2	4.5		0.000	0.0	0.0			0.2
	2	0	29.968	55.8	48.8	7.0			0.1	0.2	ENE.		0.3
	4	0	29.928	59.0	51.0	8.0			0.4	0.4	NNE.	S by W.	2.5
	6	0	29.904	60.0	52.3	7.7			0.7	0.7	SE.	SSW.	3.0
	8	0	29.917	53.8	48.3	5.5			0.8	0.5	S.	SSW.	6.0
	10	0	29.928	45.8	43.9	1.9			0.4	0.0			0.3
	18	0	29.909	41.1	39.6	1.5			0.0	0.0		SW?	9.9
	20	0	893	48.7	45.7	3.0	60.9		0.0	0.0			10.0
	22	0	874	54.0	48.6	5.4	36.5		0.0	0.0		SSE?	10.0
May	12	0	844	58.0	51.9	6.1		0.000	0.0	0.0		SW by S.	10.0
	2	0	796	57.3	50.7	6.6			0.0	0.0		SSE.	10.0
	4	0	744	55.2	51.0	4.2			0.0	0.0		SSE.	10.0
	6	0	701	56.0	50.5	5.5			0.6	0.5	SE.	S.	10.0
	8	0	686	51.4	50.8	0.6			0.6	0.0			10.0
	10	0	637	50.3	49.3	1.0			0.0	0.0			10.0
	18	0	29.476	51.6	51.1	0.5			0.5	0.0		S by W.	10.0
	20	0	462	53.0	51.5	1.5	59.1		0.6	0.2	S.	SSW.	10.0
	22	0	460	54.0	52.3	1.7	49.5		0.4	0.6	SW by S?	SW by W.	10.0
May	13	0	459	55.8	52.8	3.0		0.154	1.1	0.6	SW.	W by S.	10.0
	2	0	461	56.8	52.8	4.0			1.1	0.8	SW by W.	W by S.	10.0
	4	0	465	55.7	51.5	4.2			1.8	0.9	SW by W.	W by S.	10.0
	6	0	489	51.6	49.7	1.9			2.0	0.9	SW by W.	W.	10.0
	8	0	512	51.5	49.0	2.5			1.2	0.5	WSW.	W.	10.0
	10	0	542	50.7	48.2	2.5			1.3	0.6			10.0
May	14	0	58.5		1.2				
	18	0	29.394	47.1	46.0	1.1	46.4		0.9	0.4	NE.	E by N.	9.9
	20	0	398	47.9	46.5	1.4			0.6	0.0		E by N.	10.0
	22	0	397	49.1	47.0	2.1	62.8		0.6	0.4	ENE.	E by N.	10.0
May	15	0	399	49.1	47.6	1.5	42.6		0.6	0.2	NE.	E by N.	10.0
	2	0	400	48.2	46.8	1.4		0.019	0.6	0.4	NE by E.	E by N.	10.0
	4	0	394	47.9	46.2	1.7			1.0	0.7	E by N.	E by N.	10.0
	6	0	395	47.2	45.0	2.2			0.9	0.7	E by N.	E by N.	10.0

SPECIES OF CLOUDS, &c.	Observer's Initial.
h.	
20. Scud : woolly cirri and cirrous haze.	W
22. Id. : id.	B
0. Id. : id., stationary.	B
2. Two currents of scud + linear cirri.	B
4. Scud.	W
6. Masses of scud + cirrous haze to W. and SW.	W
8. Scud on horizon.	B
10. Scud.	B
18. Id.	W
20. Id.	B
22. Id.	W
0. Id.	W
2. Scud and loose cumuli.	W
4. Patches of scud and loose cumuli on E. and S. horizon.	W
6. Id. ; cirrous haze to E.	W
8. Patches of woolly cirri to W. ; cirrous haze to E.	W
10. Clear.	B
18. Thick fog.	W
20. Id., clearing off.	W
22. Scud.	B
0. A few patches of scud ; haze to E.	W
2. Detached masses of scud and loose cumuli ; haze on E. horizon.	W
4. Scud + haze near horizon.	W
6. Loose-edged cumuli + haze near horizon.	W
8. Id. + id. ; woolly and mottled cirri over most of the sky.	B
10. Cirrous haze to N.	B
18. Cirro-cumulous scud, moving very slowly + cirrous haze round horizon.	W
20. Sky covered with cirrous clouds and haze.	W
22. Scud + cirrous haze.	B
0. Id., cirro-cumulous scud.	B
2. Id. + thick cirro-stratus and haze.	W
4. Id. + id.	W
6. Id. + id. ; a few drops of rain.	W
8. Smart showers of rain.	B
10.	B
18. Scud + thick mass of cirrous clouds above to S. ; cirro-strati and cumulo-strati to E. and NE.	W
20. Scud ; light rain.	W
22. Id. ; id.	B
0. Id. ; passing showers.	B
2. Id. ; id.	B
4. Id.	W
6. Id. ; slight shower.	W
8. Id.	W
10. Id.	B
18. Great masses of thin scud.	B
20. Id.	B
22. Scud.	W
0. Id.	W
2. Id.	W
4. Id.	W
6. Id.	W

Göttingen Mean Time of Observation.			BARO- METER Corrected.	THERMOMETERS.				RAIN GAUGE.	ANEMOMETER.			Clouds moving from	Quan- tity of Clouds.
				Dry.	Wet.	Diff.	Max. and Min.		Pressure.		Direction of Wind.		
									Max.	Pres.			
May 15	d. 8 h. 0 m. 10	0	29.407 420	46.3 45.6	44.5 43.7	1.8 1.9	°	in.	0.9 1.2	0.8 0.3	ENE. NE by E.	E by N. E by N.	0-10. 10.0 10.0
	18	0	29.387	45.2	43.8	1.4			0.9	0.8	NE by N.	E by N.	10.0
	20	0	386	46.3	44.2	2.1	49.1		1.9	1.4	NE.	E by N.	10.0
	22	0	383	45.7	44.4	1.3	44.3		2.0	1.2	NE.		10.0
May 16	0	0	382	45.8	45.0	0.8		0.077	2.4	1.6	NE by E.		10.0
	2	0	379	45.8	45.0	0.8			1.7	1.6	NE.		10.0
	4	0	377	45.2	45.0	0.2			2.0	0.7	NE.		10.0
	6	0	372	45.7	45.5	0.2			1.0	0.5	ENE.		10.0
	8	0	409	45.6	45.1	0.5			1.1	0.6	NE by E.		10.0
	10	0	443	44.6	43.9	0.7			1.4	0.6	ENE.		10.0
	18	0	29.522	44.2	43.0	1.2			1.9	1.1	ENE.	ENE : E by N.	10.0
	20	0	554	45.7	43.2	2.5	46.1		1.8	2.1	ENE.	ENE : E by N.	10.0
	22	0	584	45.2	42.3	2.9	41.3		2.5	1.3	NE by E.	ENE.	10.0
May 17	0	0	614	46.0	42.0	4.0		0.189	2.5	0.6	NE by E.	ENE : NE.	9.0
	2	0	636	48.1	42.7	5.4			2.1	1.2	NE by E.	ENE.	9.8
	4	0	655	46.3	42.2	4.1			1.7	0.8	NE by E.	ENE.	10.0
	6	0	687	45.6	41.8	3.8			1.2	0.6	NE by E.	ENE.	10.0
	8	0	714	43.7	41.3	2.4			0.8	0.4	NE by E.	ENE.	10.0
	10	0	740	41.6	39.8	1.8			0.5	0.0		ENE.	10.0
	18	0	29.794	39.9	38.2	1.7			1.2	0.0		ENE.	10.0
	20	0	815	43.0	40.7	2.3	48.1		0.1	0.0		ENE.	10.0
	22	0	832	46.0	42.8	3.2	38.7		1.2	0.0		E by N.	9.2
May 18	0	0	842	47.4	43.6	3.8		0.013	0.9	1.0	ENE.	E by N.	9.8
	2	0	844	48.0	42.8	5.2			0.8	0.6	E by N.	E.	10.0
	4	0	847	48.8	43.6	5.2			0.9	0.6	E by N.	E.	9.9
	6	0	851	46.3	40.8	5.5			1.0	0.5	ENE.	E.	5.0
	8	0	865	45.3	40.4	4.9			0.6	0.2	ENE.	ENE.	1.0
	10	0	867	37.0	36.4	0.6			0.0	0.0		ENE ?	2.0
	18	0	29.869	35.0	34.3	0.7			0.0	0.0		E by N.	5.0
	20	0	882	42.8	40.7	2.1	49.9		0.0	0.0		E by N.	3.0
	22	0	876	46.8	42.3	4.5	30.4		0.4	0.3	SE by S.	E.	7.0
May 19	0	0	865	49.3	42.9	6.4		0.004	1.0	0.8	E by N.	ESE.	9.7
	2	0	858	50.8	43.6	7.2			1.2	0.8	E by N.	ESE.	9.5
	4	0	841	51.2	43.6	7.6			1.3	1.0	E.	SE.	8.0
	6	0	833	48.3	41.7	6.6			1.4	0.6	E.	SE.	5.0
	8	0	830	45.2	41.4	3.8			1.0	0.3	E by N.	SE.	8.0
	10	0	839	43.0	40.3	2.7			0.6	0.3	E by N.	ESE.	9.0
	18	0	29.774	43.3	41.2	2.1			0.4	0.4	E.	ESE.	9.5
	20	0	765	46.0	42.6	3.4	51.4		1.1	1.0	E by N.	ESE.	10.0
	22	0	764	47.8	44.3	3.5	41.1		1.8	1.2	E by N.	SE.	9.7
May 20	0	0	752	51.8	47.3	4.5		0.000	1.6	1.6	E by S.	ESE : SSE.	8.5
	2	0	734	56.2	49.8	6.4			1.5	1.1	E by S.	E by S.	7.0
	4	0	726	53.9	47.3	6.6			1.6	1.5	E.	ESE.	6.0
	6	0	723	50.3	45.7	4.6			1.9	1.2	E by S.	ESE.	7.0
	8	0	722	46.4	43.0	3.4			1.7	1.4	E by N.	E.	6.0
	10	0	709	43.8	41.8	2.0			1.1	0.5	ENE.	E by S.	8.5
May 21	0	0	56.9 42.9		1.4	...			
	18	0	29.555	44.6	44.0	0.6			1.7	0.5	NE.		10.0
	20	0	560	45.0	44.6	0.4	47.4		0.8	0.7	NE by N.	NE by E.	10.0
	22	0	561	44.8	44.2	0.6	43.5		0.7	0.6	NE by N.	NE by E.	10.0

SPECIES OF CLOUDS, &c.

Observer's
Initial.

h.		
8.	Scud.	W
10.	Id.	W
18.	Id.	B
20.	Id.	W
22.	Id.; rain.	W
0.	Id.; light rain.	W
2.	Id.; id.	B
4.	Id.; heavy Scotch mist.	W
6.	Id.; id.	W
8.	Scotch mist.	W
10.	Id.	
18.	Two strata of scud.	B
20.	Id.	W
22.	Scud.	W
0.	Two strata of scud + woolly and mottled cirri and large cirro-cumuli.	W
2.	Scud and loose cumuli.	W
4.	Id.	W
6.	Id.	W
8.	Id.; shower of rain.	W
10.	Id.	W
18.	Scud + thick cirrous mass; cirro-strati and cumulo-strati to NE.	W
20.	As before.	W
22.	Scud and loose cumuli.	W
0.	Id.	W
2.	Id.	W
4.	Id.	W
6.	Id. + cirro-stratus on NE. horizon.	W
8.	Large woolly cirro-cumuli + mottled cirri and cirro-strati to NE. and E.; masses of cumuli on S. horizon.	W
10.	Dark cirro-cumulous scud to N. + cirrous clouds on E. and NE. horizon.	W
18.	Cirro-cumulo-stratus + masses of loose scud; hoar-frost.	W
20.	Large woolly cirro-cumuli + sheets of mottled and woolly cirri; masses of scud and cumuli.	W
22.	Scud and cumuli + woolly and mottled cirri.	W
0.	Id.	W
2.	Id. + cirro-stratus on E. horizon.	W
4.	Scud + detached masses of cumuli.	W
6.	Id. + cirro-cumuli; cumuli on horizon.	W
8.	Id. + id.	W
10.	Id. + ranges of ragged cumuli on N. horizon.	W
18.	Id. + cumulo-strati on horizon; cirro-cumuli and cirrous haze.	W
20.	Id. + cirrous clouds.	W
22.	Id. + id.	B
0.	Id.; id.	B
2.	Cirrous scud and loose cumuli + linear cirri and cirrous haze.	B
4.	Cirrous scud + loose cumuli; cirro-cumuli, cirri and cirrous haze.	W
6.	Id. + cumuli; masses of mottled and woolly cirri and cirro-cumuli, becoming haze in some places.	W
8.	Scud, very low, and loose cumuli + a sheet of thick woolly cirri from zenith to W. horizon; cirro-cumuli to N., cirro-strati to S.; all nearly [stationary.	B
10.	Scud + cirrous haze in some places.	B
18.	Thick Scotch mist.	W
20.	Scud; light rain.	W
22.	Id.; rain.	B

Göttingen Mean Time of Observation.			BARO- METER Corrected.	THERMOMETERS.				RAIN GAUGE.	ANEMOMETER.			Clouds moving from	Quan- tity of Clouds.
				Dry.	Wet.	Diff.	Max. and Min.		Pressure.		Direction of Wind.		
									Max.	Pres.			
May	d.	h. m.	in.	°	°	°	°	in.	lbs.	lbs.			
22	0	0	29-553	45.6	45.0	0.6		0.313	0.8	0.5	NE.	NE by E.	0-10.
	2	0	545	46.3	45.9	0.4			0.8	0.5	NE.	NE by E.	10.0
	4	0	538	46.8	46.2	0.6			0.6	0.6	NE.	NE.	10.0
	6	0	543	46.3	46.0	0.3			0.5	0.3	NE.		10.0
	8	0	558	45.2	45.0	0.2			0.5	0.2	NE.		10.0
	10	0	570	44.7	44.5	0.2			0.2	0.1	NE.		10.0
	18	0	29-598	45.3	45.2	0.1			0.2	0.0			10.0
	20	0	603	45.6	45.3	0.3			0.6	0.1	NE?		10.0
	22	0	611	46.5	46.0	0.5	47.1		0.5	0.2	NE by E.		10.0
May	23	0 0	607	48.2	47.8	0.4	44.1		0.4	0.2	NE.		10.0
	2 0		604	47.9	47.3	0.6		0.039	0.9	0.8	NE by E.		10.0
	4 0		602	47.0	46.8	0.2			1.0	0.2	NE.		10.0
	6 0		595	47.0	46.8	0.2			0.4	0.2	NE.		10.0
	8 0		602	47.2	47.0	0.2			0.2	0.1	NE.	ENE.	10.0
	10 0		614	47.0	46.8	0.2			0.2	0.2	NE by N.		10.0
	18 0		29-595	46.3	46.0	0.3			0.7	0.2	ENE.		10.0
	20 0		593	46.7	46.2	0.5			0.7	0.4	NE by E.		10.0
	22 0		583	47.0	46.3	0.7	48.3		1.2	0.6	ENE.	ENE.	10.0
May	24	0 0	578	47.8	46.8	1.0	45.2		0.6	0.7	NE by E.	ENE.	10.0
	2 0		563	48.2	47.0	1.2		0.133	1.1	1.3	ENE.	ENE.	10.0
	4 0		531	47.9	45.1	2.8			1.6	1.3	NE.	ENE.	10.0
	6 10		502	47.3	44.7	2.6			2.0	1.9	NE.	E by N.	10.0
	8 0		492	45.3	44.0	1.3			2.8	1.3	NE.	ENE.	10.0
	10 0		473	44.6	44.2	0.4			1.5	0.6	NE.	ENE.	10.0
	18 0		29-320	45.7	45.5	0.2			1.6	0.0			10.0
	20 0		298	47.3	47.1	0.2	50.2		0.0	0.0			10.0
	22 0		292	49.3	49.0	0.3	43.8		0.0	0.0		SW by W.	10.0
May	25	0 0	277	51.0	50.0	1.0			0.3	0.6	SW.	SW by W.	10.0
	2 0		284	51.3	50.0	1.3		0.390	0.8	0.7	SW by S.	SW by W.	10.0
	4 0		287	50.7	49.9	0.8			1.0	0.2	SW by S.	SW by W.	10.0
	6 0		301	51.3	49.7	1.6			0.4	0.5	SW by S.	SW by W.	9.7
	8 0		317	50.7	48.3	2.4			0.7	0.4	SW by S.	SW.	9.0
	10 0		336	48.3	46.3	2.0			0.2	0.1	SW by S.		7.5
	18 0		29-287	51.7	49.4	2.3			0.3	0.0			3.0
	20 0		284	54.2	51.2	3.0			1.1	0.4	SW by S.	SSW : SSW?	9.5
	22 0		270	57.7	53.3	4.4	51.9		1.0	0.7	SW by S.	S by W : SSW.	6.5
May	26	0 0	254	57.6	53.6	4.0	41.5		1.6	0.6	SW by S.	S by W.	9.5
	2 0		233	56.2	52.6	3.6		0.149	1.3	0.8	SSW.	S by W.	10.0
	4 0		209	57.0	53.0	4.0			0.8	0.8	SW.	SW.	9.5
	6 0		200	54.2	50.1	4.1			1.6	1.3	SW.	SSW.	9.5
	8 0		195	50.9	48.0	2.9			1.2	0.4	SW.		10.0
	10 0		181	49.8	47.3	2.5			0.7	0.3	SW.	WSW.	10.0
	18 0		29-150	47.3	46.5	0.8			0.2	0.0		W.	10.0
	20 0		151	50.0	47.6	2.4			0.4	0.3	WSW.	W.	10.0
	22 0		148	50.8	47.7	3.1	60.7		0.2	0.0		W.	10.0
May	27	0 0	146	54.7	49.7	5.0	46.6		0.4	0.1	WSW.	WSW.	10.0
	2 0		138	53.0	49.3	3.7		0.064	0.7	0.2	SW.	WSW.	10.0
	4 0		121	54.2	53.1	1.1			0.6	0.0		W by S.	10.0
	6 0		108	54.2	50.1	4.1			0.5	0.2	SW by W.	W by S.	10.0
	8 0		117	51.0	49.3	1.7			0.3	0.0		W by S.	10.0
	10 0		141	49.0	47.9	1.1			0.0	0.0			10.0
May	28	0 0	56.9 42.9		3.0				

SPECIES OF CLOUDS, &c.

Observer's
Initial.

h.	0. Scud ; rain.	B
	2. Id. ; id.	B
	4. Id. ; id.	W
	6. Scotch mist.	W
	8. Id.	W
	10. Id.	W
	18. Thick Scotch mist.	W
	20. Id.	W
	22. Homogeneous scud ; light drizzle.	B
	0. Id. ; id.	B
	2. Id. ; id.	B
	4. Id. ; rain.	W
	6. Scotch mist.	W
	8. Scud ; Scotch mist ; very thick to N. and W. ; clearing to E. and SE.	B
	10. Scotch mist.	B
	18. Homogeneous scud ; mist.	W
	20. Id. ; id.	W
	22. Scud, breaking ; mist.	B
	0. Id. ; rain.	B
	2. Id. ; mist.	B
	4. Id. + cirrous clouds and haze.	W
	6. Id. + id.	W
	8. Loose scud ; light rain.	W
	10. Id. ; id.	W
	18. Rain.	W
	20. Id.	W
	22. Thin scud, falling in rain + dense watery-like cirro-stratus.	B
	0. Id., id. + id.	B
	2. Id., id. + id.	B
	4. Id., id. + id. ; breaking to S.	W
	6. Id., + dense cirro-stratus and haze ; sky to SE.	W
	8. Chiefly woolly cirri and cirrous haze + scud to NW. ; cirro-strati on E. horizon ; sky to E.	B
	10. Nearly as before ; strips of feathered cirri pointing from SW. to NE.	B
	18. Masses of scud and cumuli to SW. ; cumulo-strati on S. horizon.	W
	20. Scud : cirrous scud + cirro-strati and cumuli to S. and E.	W
	22. Loose-edged cumuli : cirrous clouds, moving slower + cumulo-strati on horizon.	B
	0. Loose cumuli + cirrous clouds ; a shower lately ; rain to SW.	B
	2. Id. + id. ; slight shower.	B
	4. Scud and loose-edged cumuli + cirro-cumulous clouds, stationary.	W
	6. Scud and loose cumuli + masses of cirrous clouds above.	W
	8. Sky covered with a sort of grey cirrous mass, falling in a slight shower ; scud on horizon.	B
	10. Cirro-cumulous scud.	B
	18. Scud + cirro-strati all round ; light drizzle.	D
	20. Id. + cirro-strati on S. and E. horizon.	W
	22. Id. + id. NE. horizon.	W
	0. Id.	B
	2. Id.	H
	4. Id. ; a few drops of rain.	B
	6. Id. + cirrous clouds and haze to E.	D
	8. Id.	W
	10. Light rain.	W

Göttingen Mean Time of Observation.			BARO- METER Corrected.	THERMOMETERS.				RAIN GAUGE.	ANEMOMETER.			Clouds moving from	Quan- tity of Clouds.	
				Dry.	Wet.	Diff.	Max. and Min.		Pressure.		Direction of Wind.			
									Max.	Pres.				
May 28	18	0	29.679	37.1	37.0	0.1		in.	lbs.	lbs.			1-10.	
	20	0	693	40.1	39.0	1.1			0.0	0.0		SW : W by N.	9.0	
	22	0	704	44.6	41.2	3.4	49.2		0.4	0.2		SSW.	5.5	
May 29	0	0	687	51.4	45.0	6.4	34.0		0.4	0.2	WSW.	W.	3.5	
	2	0	689	47.7	43.2	4.5		0.403	0.4	0.6	W by S.	W.	7.0	
	4	0	702	43.0	42.0	1.0			2.0	0.6	WNW.	W.	9.5	
	6	0	712	48.8	44.8	4.0			1.8	1.1	WSW.	W.	9.7	
	8	0	744	47.4	44.0	3.4			1.4	0.6	SW by W.	NW : W.	9.0	
	10	0	779	41.9	39.4	2.5			0.8	0.1	NE.	NW by N.	5.0	
	18	0	29.801	42.8	41.3	1.5			0.0	0.0		WNW.	6.5	
	20	0	810	45.2	43.2	2.0			0.0	0.0		W.	9.0	
	22	0	816	50.6	46.7	3.9	52.3		0.0	0.0		W.	9.0	
May 30	0	0	803	52.2	47.1	5.1	36.1		0.1	0.0		W.	9.7	
	2	0	774	56.7	49.0	7.7		0.137	0.0	0.0		W.	9.5	
	4	0	772	51.0	48.0	3.0			0.7	0.0		W.	9.3	
	6	0	767	46.3	45.0	1.3			0.5	0.2	NE.	Various.	10.0	
	8	0	739	48.0	46.0	2.0			0.2	0.0		Various : W by S.	10.0	
	10	0	728	45.8	43.9	1.9			0.3	0.1	ESE.	W ? : W by S.	10.0	
	18	0	29.560	43.3	43.0	0.3			0.9	0.5	NE by N.	ESE.	10.0	
	20	0	555	43.8	43.2	0.6			0.7	0.4	NE by N.	ENE.	10.0	
	22	0	535	44.6	43.9	0.7	58.5		0.6	0.5	NE.	ENE.	10.0	
May 31	0	0	528	46.8	46.2	0.6	42.3		0.6	0.3	NE by N.	ENE.	10.0	
	2	0	518	47.9	47.1	0.8		0.277	0.3	0.2	NE by N.	ENE.	10.0	
	4	0	516	48.3	47.7	0.6			0.2	0.1	NE.	ENE.	10.0	
	6	0	513	47.8	47.0	0.8			0.1	0.0		NE.	10.0	
	8	0	515	47.0	46.7	0.3			0.0	0.0		NE.	10.0	
	10	0	510	46.0	45.7	0.3			0.1	0.0		NE.	10.0	
	18	0	29.429	44.8	44.7	0.1			0.4	0.2	NE.	ENE.	10.0	
	20	0	417	46.8	46.1	0.7			0.2	0.2	NE.	ENE.	10.0	
	22	0	396	48.6	47.7	0.9	48.4		0.9	0.6	NE.	ENE.	10.0	
June 1	0	0	381	48.0	47.0	1.0	42.9		0.7	0.4	ENE.	ENE.	10.0	
	2	0	346	48.6	47.7	0.9		0.405	0.7	0.5	NE by E.	ENE.	10.0	
	4	0	295	48.4	47.7	0.7			0.6	0.5	ENE.	ENE.	10.0	
	6	0	238	48.8	48.1	0.7			0.7	0.2	NE.	ENE.	10.0	
	8	0	209	48.3	47.9	0.4			0.3	0.0		ENE.	10.0	
	10	0	185	47.8	47.4	0.4			0.0	0.0		ENE.	10.0	
	18	0	29.110	48.8	48.2	0.6			0.0	0.0		S by W.	10.0	
	20	0	29.094	53.8	53.0	0.8			0.0	0.1	S.	SSW.	10.0	
	22	0	29.092	57.1	55.0	2.1	48.6		0.5	0.1	SSW.	SSW.	10.0	
June 2	0	0	29.084	57.9	55.6	2.3	46.6		0.3	0.0		SSW.	10.0	
	2	0	29.057	53.7	51.9	1.8		0.121	0.9	0.9	NE by E.	NE.	10.0	
	4	0	29.032	49.8	48.7	1.1			0.8	0.7	NE by N.		10.0	
	6	0	28.983	49.0	48.2	0.8			0.9	0.5	NE by N.		10.0	
	8	0	28.976	46.6	46.4	0.2			1.0	0.5	NNE.	NNE.	10.0	
	10	0	28.970	46.2	46.0	0.2			0.8	0.6	NE by N.	NNE.	10.0	
	18	0	28.994	45.8	44.5	1.3			1.6	0.5	N ½ E.	N.	9.9	
	20	0	29.046	46.2	44.2	2.0			1.6	0.6	N by E.	N by E.	10.0	
	22	0	29.118	46.8	43.6	3.2	66.1		0.9	0.6	N by E.	NNE.	10.0	
June 3	0	0	29.175	47.5	44.0	3.5	44.5		1.1	0.4	NNE.	NNE.	10.0	
	2	0	29.234	46.5	43.9	2.6		0.420	1.1	0.4	NE by N.	NNE.	10.0	
	4	0	29.277	45.2	43.1	2.1			1.1	0.6	NE by N.	NNE.	10.0	

May 31^d 7^h. New silk put upon the wet bulb thermometer.
 June 2^d 22^h. The maximum temperature given is rather doubtful. The maximum at one time was observed to be 61°·5. If 66°·1 is an accurate indicate, the leap must have been sudden.

SPECIES OF CLOUDS, &c.

Observer's
Initial.

- h.
18. Patches of scud moving quickly : scud + linear cirri ; line of scud creeping along N. horizon. Snow seen on some of the surrounding hills, and lying on the ground an hour ago. B
20. Scud and loose cumuli. B
22. Id. W
0. Id. W
2. Id. ; passing showers. W
4. Scud ; raining, heavy shower of hail lately ; sky to N. W
6. Low masses of scud and cumuli : cirrous haze and cirro-cumuli + long ranges of cumuli and nimbi, of great height, to E. ; raining heavily to E. and S. ; sky electric looking. B
8. Scud + ranges of cumulo-strati to N. ; patches of mottled cirri. W
10. Loose cumuli + cirrous clouds. W
18. Thick cirro-cumulous scud ; sky to N. B
20. Id., more dense + scud and cumuli on N. horizon ; sky getting more to NE. B
22. Scud and loose cumuli + cirrous clouds to NE. W
0. Id. + thin cirri to E. W
2. Id. + linear cirri to NE., lying WNW. to ESE. ; raining heavily to S. At 2^h 27^m black, loose, ragged scud began to move from N., W., and E., and the wind began to blow 0·7 lb. from SSW. W
4. Scud moving from various directions, chiefly from SW. by S., and also from N. by E. ; rain. B
6. Patches of scud moving from E., NE., and W. : cirro-cumulous scud + cumulo-strati to S. ; rain. B
8. Patches of scud : cirro-cumulous scud + thick cirrous haze ; solar halo. W
10. Scud ; light rain. W
18. Id. ; rain. B
20. Id. ; heavy rain. B
22. Homogeneous ; light drizzle. W
0. Id. ; id. W
2. Scud ; light rain. W
4. Id. ; id. B
6. Id. ; id. W
8. Id. ; id. W
10. Id. ; id. W
18. Id. ; id. B
20. Id. ; id. B
22. Id. ; id. W
0. Id. ; id. W
2. Id. ; id. W
4. Id. ; id. B
6. Id. ; id. W
8. Id. ; id. W
10. Id. ; id. W
18. Scud, nearly homogeneous ; light mist ; broken a little to E. and ESE. B
20. Scud + cirrous clouds. B
22. Id. W
0. Id. W
2. Homogeneous scud ; half an hour ago the clouds were moving from S., the wind changed suddenly to NNE., and a lower stratum of scud sprung [up, moving from NE. W
4. Homogeneous scud ; mist ; light rain just commenced. B
6. Id. ; id. ; id. B
8. Scud ; light rain. W
10. Id. ; id. W
18. Scud + an opening to NNE. where cirrous clouds are seen. B
20. Id. B
22. Id. + cirro-strati on NNE. horizon. W
0. Id. W
2. Id. ; light rain. W
4. Id. ; id. B

Göttingen Mean Time of Observation.			BARO- METER Corrected.	THERMOMETERS.				RAIN GAUGE.	ANEMOMETER.			Clouds moving from	Quan- tity of Clouds.
				Dry.	Wet.	Diff.	Max. and Min.		Pressure.		Direction of Wind.		
									Max.	Pres.			
June	d. h. m.		in.	°	°	°	°	in.	lbs.	lbs.			0-10.
	3 6 0		29.313	44.3	43.2	1.1			1.4	0.3	NE by N.	NNE.	10.0
	8 0		360	43.7	42.6	1.1			1.2	0.5	NE.	NNE.	10.0
	10 0		396	43.9	43.3	0.6			0.9	0.7	NE by N.	NNE.	10.0
June	4 0 0		48.0 41.9	0.091	1.2				
	18 0		29.660	43.7	41.8	1.9			1.8	0.5	NE.	NE.	10.0
	20 0		682	43.9	40.8	3.1			1.1	0.6	NE by E.	NE.	10.0
	22 0		690	44.0	40.5	3.5	48.8		1.5	0.7	NE.	NE?	10.0
June	5 0 0		693	43.1	41.5	1.6	42.7	0.092	1.2	0.7	NE.		10.0
	2 0		694	43.4	41.8	1.6			1.2	0.6	NE by N.		10.0
	4 0		687	44.1	41.7	2.4			1.5	0.7	NE.		10.0
	6 0		682	42.6	41.3	1.3			0.8	0.8	NE by N.		10.0
	8 0		695	42.2	41.6	0.6			0.9	0.2	NE by N.		10.0
	10 0		691	42.1	41.3	0.8			0.5	0.4	NNE.	NNE.	10.0
	18 0		29.688	43.7	43.0	0.7			0.6	0.0			10.0
	20 0		700	46.6	45.0	1.6			0.4	0.3	NNE.	NNE.	10.0
	22 0		711	48.0	46.4	1.6	43.9		0.5	0.4	NNE.	NNE.	10.0
June	6 0 0		711	49.2	47.3	1.9	41.3	0.170	0.4	0.2	NE by N.	NNE.	10.0
	2 0		714	49.5	47.0	2.5			0.6	0.2	N.	N by E.	10.0
	4 0		706	52.4	48.9	3.5			0.2	0.0		N by W.	9.9
	6 0		690	51.9	48.6	3.3			0.0	0.0		N by W.	9.9
	8 0		680	51.4	48.5	2.9			0.1	0.1	N by W.	N.	9.9
	10 0		667	48.2	46.4	1.8			0.0	0.0		N.	10.0
	18 0		29.571	47.8	46.0	1.8			0.0	0.0			10.0
	20 0		559	51.4	47.3	4.1			0.0	0.0			10.0
	22 0		534	52.7	46.8	5.9	52.3		0.6	0.5	WSW.	W.	9.3
June	7 0 0		502	53.4	47.2	6.2	45.5	0.006	0.3	0.5		WSW.	5.0
	2 0		457	57.0	51.0	6.0			0.3	0.6	S by W.	WSW.	10.0
	4 0		419	56.2	52.8	3.4			0.6	0.2	SW by S.	SSW.	9.9
	6 0		359	56.3	53.9	2.4			0.3	0.0		SSW.	9.9
	8 0		299	55.4	51.9	3.5			0.4	0.4	S by E.	S.	9.9
	10 0		225	53.3	50.8	2.5			1.1	0.5	SSE.	S by E.	10.0
	18 0		28.912	53.3	50.2	3.1			2.2	1.2	SSE.	S by W.	3.0
	20 0		881	53.8	50.0	3.8			2.6	1.2	S.	S by W.	7.0
	22 0		854	56.3	51.5	4.8	59.0		3.6	1.4	S by W.	S.	10.0
June	8 0 0		836	55.0	50.8	4.2	49.3	0.168	2.8	3.4	SW by S.	S by W.	9.5
	2 0		809	58.0	52.9	5.1			3.4	1.8	S by W.	SSW.	8.0
	4 0		789	58.0	53.0	5.0			3.3	2.4	S by W. v.	S by W.	9.0
	6 0		776	53.6	50.1	3.5			2.8	0.4	S by W.	S by W.	9.8
	8 0		747	54.0	49.2	4.8			2.4	0.7	S by E.	S.	9.9
	10 0		716	52.2	48.7	3.5			2.0	2.8	SSE.	S.	10.0
	18 0		28.618	50.7	49.2	1.5			2.7	0.4	S by E.	S by W.	10.0
	20 0		28.656	53.0	51.9	1.1			0.3	0.0		W.	10.0
	22 0		28.726	56.7	52.0	4.7	59.2		0.7	0.5	W by S.	W. by N.	9.7
June	9 0 0		28.804	53.3	48.8	4.5	49.1	0.118	1.3	1.3	W by S.	W.	9.9
	2 0		28.860	55.2	50.2	5.0			1.9	1.6	W by S. v.	W.	10.0
	4 0		28.915	58.2	51.4	6.8			2.4	1.3	WSW.	W.	9.8
	6 0		28.966	54.6	50.7	3.9			2.9	1.2	WSW. v.	W.	9.8
	8 0		29.019	52.9	49.6	3.3			2.1	0.6	SW by W.	W.	10.0
	10 0		29.078	52.0	48.7	3.3			1.9	1.6	W. v.	W.	10.0
	18 0		29.248	51.2	48.3	2.9			1.9	0.8	W.	W : NW.	9.7
	20 0		315	52.7	49.5	3.2	57.0		1.0	0.6	W. v.	NW.	9.9
	22 0		370	57.6	51.8	5.8	49.6		1.0	1.2	NW by N. v.	W : NW by W : NNW.	4.0

June 74. Several swallows found dead, either from the cold or the want of food.
 June 94. The River Tweed about 5 feet above its mean height.

SPECIES OF CLOUDS, &c.	Observer's Initial.
h.	
6. Scud ; smart showers.	B
8. Id. ; light rain.	W
10. Id.	W
18. Id. ; a few drops of rain.	W
20. Id.	W
22. Id. ; light rain.	B
0. Id. ; id.	B
2. Id. ; rain.	B
4. Id.	W
6. Rain.	W
8. Id.	B
10. Scud ; rain.	B
18. Homogeneous scud.	W
20. Scud.	W
22. Id. ; a few drops of rain.	B
0. Id. ; id., occasionally ; clouds breaking.	B
2. Id.	B
4. Scud and loose cumuli ; sky to N.	W
6. Id. ; id. E.	W
8. Cirro-cumulous scud, moving very slowly + cumuli on N. horizon ; cirro-strati to E.	B
10. Id. id. id. id.	B
18. Cirro-cumulo-strati, stationary ; cumulo-strati and cirro-strati on E. horizon.	W
20. Id. [very lately.]	W
22. Cirro-cumulo-strati, moving slowly + cirro-strati to N. and E. ; black to S. ; the wind commenced blowing	B
0. Cirrous scud and loose cumuli.	B
2. Scud.	B
4. Id. ; sky to SSE.	W
6. Id. + cirro-strati to E. ; a shower of misty rain half an hour ago.	W
8. Id. + cumuli to N. ; cirro-strati to E.	B
10. Cirro-cumulo-strati.	B
18. Scud + cumuli on E. horizon.	W
20. Id. + id. ; a few drops of rain.	W
22. Id. ; light rain.	B
0. Id. + cirrous clouds ; cumuli on horizon.	B
2. Id. + mottled cirri and cirrous haze ; heavy showers occasionally.	B
4. Scud and loose cumuli + linear and woolly cirri and patches of cirrous haze ; heavy showers occasionally.	W
6. Scud + cirrous clouds.	W
8. Id., some of it very low + cirrous haze.	B
10. Id. ; light rain.	B
18. Id. ; the clouds have a bluish appearance to E. ; a few drops of rain.	W
20. Id. ; light rain.	W
22. Scud and cumulo-strati + cirrous clouds.	B
0. Scud ; occasional showers ; sky to W.	B
2. Id. ; id.	B
4. Id. + cirrous clouds ; drops of rain.	B
6. Id. + id.	W
8. Id.	W
10. Id.	B
18. Patches of loose scud to S. : cirrous scud + large cirro-cumuli and thick masses of cirro-strati and haze.	W
20. Dense mass of cirro-stratus + patches of scud to S. ; broken to N. ; shower of rain. [horizon.]	W
22. Scud : scud : cumuli and cirro-strati ; currents of the lowest scud varying from N. to W. ; cumulo-strati on	B

Göttingen Mean Time of Observation.			BARO- METER Corrected.	THERMOMETERS.				RAIN GAUGE.	ANEMOMETER.			Clouds moving from	Quan- tity of Clouds.
				Dry.	Wet.	Diff.	Max. and Min.		Pressure.		Direction of Wind.		
									Max.	Pres.			
June 10	d. h. m.		in.	°	°	°	°	in.	lbs.	lbs.			0-10.
	0 0		29.419	57.8	51.6	6.2		0.020	2.1	1.8	NW by N. v.	WNW : NW by W : WNW.	5.0
	2 0		471	54.0	51.9	2.1			3.5	1.3	W. v.	NW by N : NW by N.	7.0
	4 0		504	61.2	53.0	8.2			2.0	1.4	WNW. v.	NW by N.	6.5
	6 0		548	59.2	51.8	7.4			2.2	1.7	NW.	NW by N : NNW.	9.0
	8 0		612	55.6	50.2	5.4			1.7	0.9	NNW.	NNW.	10.0
	10 0		665	52.3	49.0	3.3			0.6	0.0		NNE.	5.0
June 11	0 0		62.1		1.6				
	18 0		29.982	48.5	46.0	2.5	45.5		1.7	0.0		NNE.	10.0
	20 0		980	49.2	47.0	2.2			0.3	0.2	NE.	NNE.	10.0
	22 0		988	49.3	47.1	2.2	58.4		0.4	0.4	NE by N.	NNE.	10.0
June 12	0 0		990	50.2	46.5	3.7	48.6		0.5	0.4	NE by N.	NE by N.	10.0
	2 0		986	51.2	48.3	2.9		0.078	0.5	0.4	NE by N.	NE by N.	10.0
	4 0		979	50.6	47.6	3.0			0.5	0.4	NE by N.	NE.	10.0
	6 0		980	48.5	45.8	2.7			0.6	0.3	NE by N.	NE by E.	10.0
	8 0		976	46.1	44.6	1.5			0.7	0.2	NE by N.	NE by E.	10.0
	10 0		985	45.2	44.0	1.2			0.4	0.1	NE by N.	NE by E.	10.0
	18 0		29.969	44.3	43.8	0.5			0.5	0.2	NE by N.	NNE.	10.0
	20 0		970	46.0	44.4	1.6			0.6	0.2	NE by N.	NNE?	10.0
	22 0		970	47.2	45.5	1.7	52.6		0.5	0.4	NE by N.	NE by N?	10.0
June 13	0 0		949	51.8	48.5	3.3	43.3		0.5	0.6	NE by N.	NNE.	9.5
	2 0		945	51.4	48.7	2.7		0.010	1.2	0.7	NE by N.		10.0
	4 0		932	50.4	48.8	1.6			0.8	0.3	NE by N.	NE?	10.0
	6 0		935	49.8	48.2	1.6			0.5	0.2			10.0
	8 0		935	48.0	47.1	0.9			0.4	0.3	NE.		10.0
	10 0		956	47.4	46.7	0.7			0.4	0.0			10.0
	18 0		29.953	49.4	48.3	1.1			0.3	0.0		NE?	10.0
	20 0		956	53.9	51.0	2.9			0.4	0.4	NE by E.	ENE.	1.2
	22 0		955	56.9	53.5	3.4	51.9		0.7	0.5	NE by N.	ENE.	0.5
June 14	0 0		963	59.3	55.3	4.0	43.5		1.3	1.3	NE.	ENE.	1.2
	2 0		957	59.3	55.6	3.7		0.005	1.2	0.7	ENE.	ENE.	2.0
	4 0		956	58.8	54.6	4.2			1.4	0.5	NE by N.		0.3
	6 0		946	58.7	55.0	3.7			0.8	0.5	NE by E.		0.3
	8 0		960	55.8	52.7	3.1			0.6	0.4	NE. v.		0.1
	10 0		991	50.0	49.0	1.0			0.5	0.0			10.0
	18 0		29.985	52.0	49.0	3.0			0.6	0.0		E?	0.5
	20 0		996	55.0	51.0	4.0			0.1	0.2	ENE.		0.1
	22 0		991	58.9	54.4	4.5	60.6		0.4	0.2	ENE.		0.0
June 15	0 0		982	64.2	57.1	7.1	47.1		0.5	0.6	ENE.	E?	0.2
	2 0		979	64.4	57.7	6.7		0.000	0.8	0.6	ENE.		0.1
	4 0		966	64.0	57.1	6.9			0.8	0.5	NE. v.		0.1
	6 0		945	64.8	56.4	8.4			0.6	0.5	NE by E. v.		0.0
	8 0		951	62.3	55.8	6.5			0.5	0.1	NE by E.		0.3
	10 0		967	53.1	49.7	3.4			0.4	0.0			2.0
	18 0		29.939	50.2	49.0	1.2			0.0	0.0		E.	6.0
	20 0		931	57.1	53.1	4.0			0.0	0.0			7.0
	22 0		922	62.1	56.0	6.1	65.4		0.1	0.1	ENE.		6.0
June 16	0 0		911	65.7	56.0	9.7	41.5		0.6	0.6	NNE. v.		3.0
	2 0		905	66.7	57.0	9.7		0.000	1.0	0.7	NE by N.		3.0

SPECIES OF CLOUDS, &c.	Observer's Initial.
h.	
0. Scud : scud : large sheet of cirrous-fringed cloud rising from W. and falling in rain ; a few drops here.	B
2. Scud : cumuli and nimbi ; a shower approaching. 1 ^h 25 ^m a heavy shower of rain, then of hail, followed by lightning and thunder ; loud peals distant about 1 mile at an altitude of 45°.	B
4. Scud and cumuli.	W
6. Id. to SE. : cirro-cumulous scud + masses of cirro-cumuli and cirrous clouds.	W
8. Scud ; light rain.	B
10. Cirrous scud.	B
18. Scud.	B
20. Id.	B
22. Id.	W
0. Id.	B
2. Id.	W
4. Id.	W
6. Id.	B
8. Id. ; a few drops of rain.	W
10. Id.	W
18. Id. ; drizzle.	B
20. Id.	B
22. Id.	W
0. Id. + woolly and mottled cirri.	W
2. Id.	W
4. Id.	B
6. Id. ; light mist.	B
8. Id.	W
10. Id.	W
18. Thin low floating scud ; mist.	B
20. Strings of scud ; cirro-strati to S.	B
22. Patches of scud moving quickly and becoming dispersed ; cirri.	W
0. Patches of scud + masses of woolly cirri and cirro-cumuli to S. and W.	W
2. Masses of scud near horizon.	W
4. Id.	B
6. Id.	B
8. Id.	B
10. Homogeneous scud.	W
18. Scud on E. and S. horizon.	B
20. Id.	B
22. Clear.	W
0. Id. ; a few small patches of scud to S.	W
2. Id. ; id.	W
4. One or two specks of scud to SE. and S.	B
6. Not a speck of cloud to be seen.	B
8. Cirrous haze and cirro-strati forming to NE.	W
10. Woolly cirri, cirro-cumuli, cirro-strati, and cirrous haze to N. and NE. all tinged with red.	W
18. Cirrous haze and long feathers of woolly cirri pointing from NE., linear cirri pointing from E., moving slowly. Beautiful solar halo, incomplete near the horizon, with parhelia ; the parhelia are elongated from the sun ; at the vertex of the arch there is also a large bright mass 3° or 4° broad ; the halo has a reddish-brown colour, and the parhelia are like suns seen through a thick haze. 18 ^h 4 ^m . The parhelia to the south and at the vertex of the halo are in a thickish woolly cirrus, the parhelion to the north is in a homogeneous mass of haze or compact linear cirri.	B
20. Cirrous haze and linear cirri—no halo.	B
22. Id. id. Distinct solar halo ; brightest and of a brownish-red colour at the east and west points, less distinct and white at the north and south points.	W
0. As before. The halo still visible but faint.	W
2. Mottled and woolly cirri to SW. lying WNW. to ESE.	W

Göttingen Mean Time of Observation.			BARO- METER Corrected.	THERMOMETERS.				RAIN GAUGE.	ANEMOMETER.			Clouds moving from	Quan- tity of Clouds.
				Dry.	Wet.	Diff.	Max. and Min.		Pressure.		Direction of Wind.		
									Max.	Pres.			
June 16	d. h. m.	in.	°	°	°	°	in.	lbs.	lbs.			0-10.	
	4 0	29.894	65.1	56.0	9.1			0.7	0.7	NE.	E.	5.0	
	6 0	894	63.8	53.0	10.8			0.6	0.3	NE by N.		4.0	
	8 0	893	59.2	50.4	8.8			0.4	0.4	NE by N.		3.5	
	10 0	899	51.0	48.0	3.0			0.0	0.0			4.0	
	18 0	29.909	49.1	46.9	2.2			0.2	0.1	NE by N?	NNE.	9.0	
	20 0	925	50.4	47.1	3.3			0.4	0.3	NE by N.	NNE.	9.7	
	22 0	915	52.3	48.6	3.7	66.5		0.4	0.2	NE by N.	NNE.	8.8	
June 17	0 0	906	55.9	51.7	4.2	42.0	0.000	0.4	0.4	NE by N.	NNE.	6.7	
	2 0	897	54.9	51.0	3.9			0.4	0.3	ESE.	E.	1.0	
	4 0	863	58.0	53.0	5.0			0.2	0.1	NE by E.		0.3	
	6 0	842	61.0	55.0	6.0			0.1	0.1	NE by E.		0.0	
	8 0	844	54.9	51.3	3.6			0.3	0.3	NE.		0.0	
	10 0	852	47.2	46.6	0.6			0.3	0.1	NE.		10.0	
June 18	0 0	61.9	0.000	0.2					
	18 0	29.807	46.6	45.8	0.8	45.3		0.5	0.5	NE by N.	NE by N.	10.0	
	20 0	816	48.0	46.3	1.7			0.6	0.4	NE by N.	NE by N.	10.0	
	22 0	828	48.8	46.3	2.5	58.4		0.6	0.5	NE by N.	NE by N.	10.0	
June 19	0 0	835	50.8	47.8	3.0	45.4	0.007	0.9	0.4	NE by N.	NE by N.	10.0	
	2 0	843	52.0	48.6	3.4			1.0	0.5	NE by N.	NNE.	9.9	
	4 8	843	51.0	48.0	3.0			0.8	0.3	NE by N.	NE by N.	10.0	
	6 0	842	51.5	48.0	3.5			0.4	0.2	NE by N.	NNE.	9.9	
	8 0	864	49.5	46.2	3.3			0.4	0.2	NE by N.	NNE? : N.	5.0	
	10 0	890	46.0	44.3	1.7			0.1	0.0		NNE.	9.5	
	18 0	29.929	47.3	44.0	3.3			0.2	0.0		N.	10.0	
	20 0	938	51.1	47.0	4.1	52.5		0.0	0.0		NNE.	10.0	
	22 0	952	55.3	50.0	5.3	44.3		0.2	0.1	NE by N.	NNW.	9.0	
June 20	0 0	951	55.8	50.2	5.6		0.000	0.1	0.1	E?	NNW, W, SSW.	3.0	
	2 0	945	59.8	53.2	6.6			0.1	0.0	SW by S.	W?	2.0	
	4 0	917	63.7	55.6	8.1			0.1	0.0	ESE.		8.0	
	6 0	886	66.1	57.7	8.4			0.1	0.0			9.8	
	8 0	869	58.8	53.8	5.0			0.1	0.0	NNE.	N by W.	7.0	
	10 0	864	56.0	53.9	2.1			0.1	0.0	SW by W.		8.0	
	18 0	29.745	54.2	51.0	3.2			0.8	0.6	SW by S.	NW.	8.0	
	20 0	737	56.2	53.6	2.6			1.5	0.3	WSW.	WSW : W.	10.0	
	22 0	727	59.1	54.2	4.9	69.1		0.7	1.4	SW by W.	W.	10.0	
June 21	0 0	732	60.2	54.4	5.8	49.4	0.000	1.0	0.2	WSW.	W.	9.0	
	2 0	717	63.1	56.7	6.4			1.0	1.0	W by S.	W.	6.0	
	4 0	713	64.7	56.7	8.0			1.1	0.8	WSW.	W by N.	8.5	
	6 0	696	63.3	56.3	7.0			1.1	1.0	WNW. v.		6.0	
	8 0	703	61.7	54.8	6.9			0.9	0.7	W. v.		0.5	
	10 0	741	53.4	50.2	3.2			0.2	0.0			0.4	
	18 0	29.792	51.3	48.1	3.2			0.0	0.0		W by N.	8.5	
	20 0	813	57.0	51.0	6.0	66.2		0.0	0.0			9.0	
	22 0	818	59.4	52.2	7.2	46.1		0.0	0.0			9.0	
June 22	0 0	821	61.0	52.1	8.9		0.000	0.0	0.0		W by N.	6.0	
	2 0	819	62.7	54.0	8.7			0.1	0.0		NW.	6.0	
	4 0	815	63.7	54.7	9.0			0.2	0.3	ESE.	NW.	4.0	
	6 0	804	64.0?	54.8?	9.2			0.1	0.0			1.0	
	8 0	815	60.8	54.2	6.6			0.0	0.0			1.5	
	10 0	837	52.3	49.1	3.2			0.3	0.2	NE by N.		0.8	

SPECIES OF CLOUDS, &c.

Observer's
Initial.

h.		
4.	Linear and mottled cirri lying principally N. and S., moving very slowly.	B
6.	Reticulated cirri pointing N. to S. and E. to W.; sky very white on horizon.	B
8.	Woolly and mottled cirri.	W
10.	Woolly and woven cirri and cirrous haze.	W
18.	Scud; sky in zenith.	B
20.	Id.	B
22.	Id.	W
0.	Id.	W
2.	Masses of scud, apparently two currents, the mean direction of which is from about E.	W
4.	Small patches of scud and cirrous haze to E.	B
6.	Cirrous haze on E. horizon.	W
8.	Id.	W
10.	Homogeneous misty scud.	W
18.	Scud; a few drops of rain.	W
20.	Id.	W
22.	Id.	B
0.	Id.	B
2.	Id.	B
4.	Id.	W
6.	Id.	W
8.	Scud: woolly cirri, moving slowly; cirro-strati to E. and N.	B
10.	Waved mass of cirro-cumuli, streaked, reddish, and bluish, NE. horizon red. About an hour ago the sky began to be covered with fine cirro-cumuli, which assumed, in masses, forms like waves or undulations, the forms varying much and the cirro-cumuli becoming larger; they moved very rapidly from NNE. (quick moving cirro-cumuli are rarely seen.)	B
18.	Cirro-stratous scud moving very slowly.	W
20.	Scud, moving slowly.	W
22.	Large masses of cirrous-edged cirro-cumulo-strati.	B
0.	Patches of cirrous scud from various directions, chiefly from NNW.; cirrous haze on horizon.	B
2.	Scud; cirrous haze on horizon.	B
4.	Woolly and curled cirri and cirrous haze; band of cumulo-strati to S.	W
6.	Thick mass of cirrous clouds and haze.	W
8.	Varieties of cirri, scattered in all directions over the sky, moving very slowly.	B
10.	Masses of cirri and cirrous haze.	B
18.	Cirro-cumulo-strati and large cirro-cumuli, moving slowly + mottled cirri.	W
20.	Scud to S.: cirro-cumulo-strati.	W
22.	Mottled, ragged, and other kinds of scud + dense cirro-cumuli and cirrous haze; electric-looking.	B
0.	Scud + cirro-strati and linear cirri.	B
2.	Scud and loose cumuli + cirri to S.	W
4.	Scud and loose cumuli.	W
6.	Id.	W
8.	Cirro-strati on horizon.	B
10.	Id. to E. and N.; red to N.	W
18.	Cirro-cumuluous scud + cirro-cumuli and woolly cirri; cumulo-strati on E. and S. horizon.	W
20.	Cirro-strati diverging from NW.; dark cumuli to N.; cirro-cumuli to E. and S.	H
22.	Cirro-cumuluous-cirrous-edged cumuli; fine linear cirri.	H
0.	Scud and cumuli + cirrous haze on E. horizon.	W
2.	Cirrous-edged cumuli + masses of woolly cirri.	B
4.	Id. in detached masses + masses of cirro-cumuli to E.	W
6.	Patches of cumuli on horizon.	H
8.	Cirrous scud.	D
10.	Red and grey cirro-cumuli to N.; haze to E.	D

DAILY METEOROLOGICAL

Göttingen Mean Time of Observation.			BARO- METER Corrected.	THERMOMETERS.				RAIN GAUGE.	ANEMOMETER.		Clouds moving from	Quan- tity of Clouds.
				Dry.	Wet.	Diff.	Max. and Min.		Pressure.			
d.	h.	m.	in.	°	°	°	°	in.	lbs.	lbs.		0-10.
June 22	18	0	29.875	49.3	47.9	1.4			0.5	0.0		10.0
	20	0	871	53.0	50.4	2.6			0.0	0.0	W by S.	5.0
	22	0	862	58.3	54.0	4.3	66.5		0.1	0.0		0.3
June 23	0	0	852	62.8	56.9	5.9			0.0	0.0	WNW ?	0.8
	2	0	831	69.8	61.2	8.6		0.000	0.1	0.3	NE by N.	7.0
	4	0	832	62.3	56.0	6.3			0.9	1.2	NE by E.	8.0
	6	0	827	63.0	56.5	6.5			1.0	0.2	NE.	6.0
	8	0	837	59.8	54.0	5.8			0.5	0.3	NE.	2.0
	10	0	862	53.9	50.2	3.7			0.4	0.1	NE by N.	3.0
	18	0	29.867	50.0	48.6	1.4			0.0	0.0		0.2
June 24	20	0	874	56.8	52.2	4.6	72.7		0.0	0.2	NE.	3.0
	22	0	870	59.8	54.8	5.0			0.2	0.1	NE by N.	8.7
	0	0	869	62.9	55.9	7.0	42.3		0.1	0.1	NE by E.	9.7
	2	0	853	60.1	55.2	4.9		0.000	0.2	0.2	NE by E.	3.0
	4	0	842	62.0	56.0	6.0			0.3	0.2	ENE.	1.0
	6	0	837	60.7	55.3	5.4			0.5	0.4	ENE.	0.3
	8	0	859	52.9	48.2	4.7			0.4	0.1	ENE.	0.3
June 25	10	0	870	48.4	47.2	1.2			0.1	0.1	ENE.	4.0
	0	0	63.9		0.000	0.5		
	18	0	29.765	49.9	47.0	2.9	47.2		0.5	0.1	NE by N.	10.0
	20	0	766	50.2	47.8	2.4			0.3	0.2	NNE.	10.0
	22	0	759	52.2	48.6	3.6			0.3	0.2	NE by N.	10.0
	0	0	760	54.3	49.9	4.4	56.1		0.5	0.2	NE by E.	10.0
	2	0	747	58.7	52.6	6.1	47.8		0.5	0.3	NE.	7.7
June 26	4	0	731	58.4	52.7	5.7		0.000	0.5	0.2	NE.	6.0
	6	0	708	56.2	52.5	3.7			0.5	0.4	NE.	9.0
	8	0	712	52.3	49.7	2.6			0.3	0.2	NE.	9.5
	10	0	712	50.2	48.0	2.2			0.2	0.0	NE.	6.0
	18	0	29.646	49.9	47.9	2.0			0.5	0.2	NE.	10.0
	20	0	647	50.7	48.2	2.5			0.3	0.3	NNE.	10.0
	22	0	639	51.7	49.2	2.5	59.7		0.4	0.3	NNE.	10.0
June 27	0	0	641	52.9	49.6	3.3	41.5		1.0	0.5	NE by N.	10.0
	2	0	619	53.9	49.3	4.6		0.000	1.2	0.8	NNE.	9.8
	4	0	613	54.8	48.5	6.3			2.0	1.4	NE.	7.0
	6	0	607	52.0	46.8	5.2			1.6	0.5	NE by N.	9.7
	8	0	588	50.1	45.7	4.4			1.5	1.0	NE.	7.0
	10	0	584	46.3	42.7	3.6			0.8	0.4	N by E.	3.0
	18	0	29.503	46.4	43.6	2.8			1.4	0.6	N.	9.3
June 28	20	0	511	49.4	45.0	4.4			2.2	1.5	N.	9.0
	22	0	499	51.6	45.6	6.0	55.9		2.8	1.7	N by W.	9.5
	0	0	500	52.9	46.7	6.2	44.0		1.8	1.6	N.	9.8
	2	0	511	53.3	46.7	6.6		0.000	2.8	1.2	N.	9.8
	4	0	526	52.2	46.0	6.2			2.2	0.7	NNE.	9.0
	6	0	517	53.2	46.7	6.5			1.6	1.4	N by E.	9.8
	8	0	539	50.0	44.2	5.8			1.3	0.4	N by E.	8.0
June 29	10	0	553	44.6	42.3	2.3			0.6	0.0	NNW.	5.0
	18	0	29.540	47.8	44.1	3.7			0.1	0.1	NNW.	9.3
	20	0	544	50.2	46.2	4.0			0.2	0.1	NNW.	10.0
	22	0	542	52.4	46.1	6.3	55.3		0.3	0.2	N.	10.0
	0	0	539	56.3	49.0	7.3	43.2		0.2	0.2	NW.	9.8
2	0	527	56.1	50.4	5.7		0.000	0.4	0.0		10.0	

June 23^d 3^b. Extra boards put round the sides of the thermometer case to guard the thermometers more effectually from the sun.

SPECIES OF CLOUDS, &c.

Observer's
Initial.

18. Fog.	W
20. Scud.	W
22. Cirro-strati to ENE.	B
0. Patches of small loose cumuli.	B
2. Loose-edged cumuli : large cirro-cumuli.	W
4. Cirro-cumuli-strati + cumulo-strati to S.	W
6. Id. + cirrous haze on horizon.	W
8. Id., thick to E. and becoming haze, lying in lines from NW.	B
10. Id. + bank of cirrous clouds to E. ; sky hazy.	B
18. Loose scud on E. horizon ; slight haze.	W
20. Masses of scud.	W
22. Cirrous scud.	B
0. Small cirrous-edged cumuli.	B
2. Scud, two currents meeting : mottled and reticulated cirri.	B
4. Loose cirro-cumuli + patches of scud to W. and NE. ; masses of woolly and mottled cirri.	W
6. Patches of scud to E.	W
8. Id.	B
10. Thin smoky scud, becoming bluish to SE.	B
18. Scud.	B
20. Id.	B
22. Id.	W
0. Id.	W
2. Loose cumuli : woolly cirri.	W
4. Cirrous scud and loose cumuli, various currents.	B
6. Id.	B
8. Scud ; a streak of cirrus to NE.	W
10. Smoky scud : cirro-cumuli and woolly cirri + large red sheets of cirri and cirro-cumuli to N.	W
18. Scud.	B
20. Id.	B
22. Id.	W
0. Id.	W
2. Id.	W
4. Loose-edged cumuli, cumulo-strati and cirro-stratous scud : cirro-cumuli.	B
6. Scud.	B
8. Scud and loose cumuli : cirro-stratous scud and cirro-cumuli + cumulo-strati on N. and S. horizon.	W
10. Masses of scud.	W
18. Scud : woolly cirri and large thin cirro-cumuli ; a few drops of rain ; showers around.	B
20. Id. : id.	B
22. Id. : cirro-cumulo-strati.	W
0. Scud and loose cumuli.	W
2. Id.	W
4. Loose cumuli, scud, and masses of cirrous clouds.	B
6. Id., id. + cirro-cumuli ; cirro-strati on NE. horizon.	W
8. Cirro-cumulo-strati and cirro-strati + cumulo-strati on E. horizon ; mottled cirri to N.	W
10. Scud, cirro-cumuli and woolly cirri.	W
18. Smoky scud, ragged-edged cirro-cumuli ; sky and cirro-strati to W. ; thick clouds to E.	B
20. Scud.	B
22. Id.	W
0. Scud and cumuli + cirro-cumuli and cirrous clouds.	W
2. Scud + thick mass of cirro-stratus and haze.	W

Göttingen Mean Time of Observation.			BARO- METER Corrected.	THERMOMETERS.				RAIN GAUGE.	ANEMOMETER.			Clouds moving from	Quan- tity of Clouds.
				Dry.	Wet.	Dif.	Max. and Min.		Pressure.		Direction of Wind.		
									Max.	Pres.			
June 29	d. h. m.	in.	°	°	°	°	in.	lbs.	lbs.			0-10.	
	4 0	29.503	58.9	52.8	6.1			0.2	0.1	SW by S.	NW by N.	10.0	
	6 0	491	55.8	53.1	2.7			0.2	0.0		WNW : NW.	9.8	
	8 0	494	59.3 ?	52.8 ?	6.5 ?			1.5	0.5	W ?	WNW.	3.0	
	10 0	512	52.6	49.1	3.5			0.4	0.1	W ?		3.5	
	18 0	29.524	52.3	49.4	2.9			0.5	0.2	SW by W.	W.	10.0	
	20 0	525	54.0	50.1	3.9	60.7		0.4	0.3	W by S.	W.	10.0	
	22 0	509	56.0	51.4	4.6	45.5		0.4	0.6	W by S.	W.	9.9	
June 30	0 0	498	59.6	53.0	6.6		0.005	0.7	0.3	NW.	W.	10.0	
	2 0	489	60.9	53.8	7.1			1.9	0.4	WSW.	W.	10.0	
	4 0	479	60.8	53.8	7.0			1.3	0.4	W.	W.	9.5	
	6 0	484	60.0	54.2	5.8			1.5	1.8	W.		8.5	
	8 0	498	56.6	51.5	5.1			1.3	1.2	W.	W by N.	8.0	
	10 0	517	55.2	50.6	4.6			0.8	0.2	W by N.	WNW.	8.0	
	18 0	29.607	52.7	49.0	3.7			0.5	0.4	SW by W.	WNW.	3.5	
	20 0	603	56.9	52.1	4.8	62.3		0.5	0.7	W by S.	WSW : W by N.	8.5	
	22 0	601	59.0	54.2	4.8	47.4		1.1	0.9	SW by W.	WSW.	10.0	
July 1	0 0	598	61.0	55.9	5.1		0.000	0.9	0.4	SW by S.	WSW.	10.0	
	2 0	582	62.7	57.0	5.7			1.3	0.8	SW.	WSW.	10.0	
	4 0	573	60.9	56.2	4.7			2.7	1.7	SW.	SW by W : W by S.	10.0	
	6 0	539	60.5	55.5	5.0			2.0	1.6	SW by S.	SW : WSW.	10.0	
	8 0	508	57.3	54.4	2.9			3.0	1.8	SW by S.	SW.	10.0	
	10 0	482	55.8	54.6	1.2			2.7	1.8	SW.	SW.	9.5	
July 2	0 0	64.3		2.2					
	18 0	29.388	59.6	56.7	2.9	49.4		3.8	2.5	SW.	SW : W.	9.8	
	20 0	405	60.3	55.9	4.4			2.8	2.8	SW.	SW.	6.5	
	22 0	426	61.5	56.7	4.8	66.4		3.6	3.4	SW.	SW.	10.0	
July 3	0 0	460	64.3	58.0	6.3	56.5		4.4	2.2	SW.	WSW.	9.0	
	2 0	464	65.2	57.8	7.4		0.083	5.1	4.3	SW.	SW by W.	3.0	
	4 0	491	64.2	57.0	7.2			4.3	3.0	SW.	SW : WSW.	8.5	
	6 0	501	62.0	56.3	5.7			4.7	2.3	SW.	WSW.	3.5	
	8 0	558	59.3	55.0	4.3			2.7	1.6	SW.	WSW.	3.0	
	10 0	590	54.0	52.0	2.0			1.2	0.3	SW.	WSW.	0.8	
	18 0	29.666	50.4	49.3	1.1			0.3	0.0			0.3	
	20 0	683	54.8	51.6	3.2	66.1		0.4	0.4	SW by S.	WSW.	0.8	
	22 0	692	60.0	53.0	7.0	46.3		0.7	1.0	SW by S.	SW by W.	3.0	
July 4	0 0	693	62.8	54.0	8.8		0.006	1.1	0.5	SW by W.	SW by W.	7.0	
	2 0	688	66.8	56.6	10.2			1.3	0.7	SW.	WSW.	4.5	
	4 0	679	66.0	53.8	12.2			1.0	0.5	SW.	WSW.	2.5	
	6 0	660	65.0	54.3	10.7			0.6	0.0			9.5	
	8 0	646	58.0	53.8	4.2			0.1	0.0		S.	9.0	
	10 0	635	57.8	54.1	3.7			0.0	0.0			10.0	
	18 0	29.537	55.1	54.6	0.5			0.0	0.0			10.0	
	20 0	524	58.1	57.0	1.1	67.2		0.0	0.0		SW.	10.0	
	22 0	511	63.3	59.4	3.9	52.0		0.0	0.0		SSW.	10.0	
July 5	0 0	510	62.9	60.3	2.6		0.247	0.0	0.0		S.	10.0	
	2 0	477	66.0	62.0	4.0			0.1	0.1	NE.	SSE.	10.0	
	4 0	431	62.7	60.4	2.3			0.6	0.5	NE by E.	SSE.	10.0	
	6 0	389	61.1	61.0	0.1			0.9	0.2	NE by E.	S.	10.0	

July 5^d 6^h. Extra observations of the Barometer made simultaneously at Berwick and Makerstoun.

SPECIES OF CLOUDS, &c.	Observer's Initial.
h.	
4. Scud ; black to NW. and over the zenith.	B
6. Id. : cirrous clouds ; light rain lately, raining to SE. and E. ; clouds breaking, sky in zenith and to W. ; cumuli to SSE.	B
8. Scud + linear cirri, covering much of the sky ; sheets of cirro-strati radiating from SE. where it is quite dark and like rain.	B
10. Masses of scud and cumuli near horizon to S. and E. ; cirro-cumuli and sheets of linear cirri tinged with red.	W
18. Scud + linear cirri and cirro-strati to E.	B
20. Id. + id.	B
22. Id. + woolly and mottled cirri.	W
0. Id.	W
2. Id. + cirrous clouds and haze.	W
4. Scud, cumuli, cumulo-strati and woolly cirro-cumuli ; mountainous, ragged, and stormy-like cumuli to W. and SW., cumulo-strati with curled fronts ; the sky has been very stormy-looking for the last two hours.	B
6. Large thick masses of loose cumuli and scud, cumuli in strings like beads, cumulo-strati ; thick woolly cirro-cumuli, linear cirri and cirrous haze scattered across the sky, cirro-strati to E. ; the clouds are of all shades and thicknesses, black as night, white as snow, thin as smoke, thick as mud ; the sky is of different tints, bluish, whitish, greenish ; clouds moving at different elevations, and with different velocities.	B
8. Scud and cumuli + cumulo-strati, cirro-strati and mottled cirri.	W
10. Scud + cumulo-strati on N. horizon.	W
18. Cirro-cumulous scud, cirro-cumuli + fine cirri to NW. ; ranges of cirro-strati to E. and S.	B
20. Scud and cumuli : cirro-cumuli of various sizes and density + fine lines of cirri to S. ; black mass of scud rising in W.	B
22. Scud + cirro-strati to E. ; a few drops of rain.	W
0. Id.	W
2. Id. + cirrous clouds and haze to E.	W
4. Scud and loose cumuli : cirro-cumulous scud and thick cirro-cumuli ; cirrous haze over the sky ; very stormy-looking ; shower lately.	B
6. Scud : thick cirro-strati and sheets of cirri.	B
8. Id. ; a few drops of rain.	W
10. Id., moving quickly + cirro-cumuli and cirrous haze ; light rain.	W
18. Loose scud : woolly cirro-cumuli.	W
20. Scud.	W
22. Id. ; a few drops of rain.	B
0. Cirrous scud ; sky in patches.	B
2. Scud, chiefly near horizon.	B
4. Id. : cirro-stratous scud + cumuli near horizon.	W
6. Id. + patches of woolly cirri ; cumuli on N. and S. horizon.	W
8. Sheets of cirrous scud + beautiful ranges of pyramidal cumuli to S. and N. ; cirro-strati to E.	B
10. Cirrous scud + cumuli to N. ; cirro-strati to E.	B
18. Masses of cumulo-strati on SE. horizon ; patches of scud to S. and N.	W
20. Patches of scud + large masses of cumuli and cumulo-strati on S. and N. horizon.	W
22. Cirrous-edged cumulo-strati.	B
0. Id.	W
2. Cirrous cirro-cumuli + cumulo-strati ; linear cirri rising from a patch of cirrous haze to W. and pointing [from WNW.	B
4. Cirrous-edged cumuli, woolly, linear, and mottled cirri.	W
6. Thick cirrous haze and linear cirri ; cumulo-strati on E. and N. horizon.	W
8. Scud + cirrous haze, thick to W. ; solar halo.	B
10. Thick mass of cirro-stratus and haze, cedaraceous.	B
18. Scotch mist.	W
20. Scud.	W
22. Id., moving slowly.	W
0. Id. ; dense cirro-stratus, a few drops of rain.	W
2. Id. ; id. ; hazy.	W
4. Id. ; id.	W
6. Id. + cirrous clouds and haze ; heavy thunder showers lately.	W

Göttingen Mean Time of Observation.			BARO- METER Corrected.	THERMOMETERS.				RAIN GAUGE.	ANEMOMETER.			Clouds moving from	Quan- tity of Clouds.	
				Dry.	Wet.	Diff.	Max. and Min.		Pressure.		Direction of Wind.			
									Max.	Pres.				
July	d.	h.	m.	in.	°	°	°	°	in.	lbs.	lbs.		0-10.	
	5	8	0	29.303	58.5	57.8	0.7			0.7	0.4	NE by E.	ENE : SSW.	10.0
		10	0	322	57.0	56.9	0.1			0.4	0.0		S.	10.0
		18	0	29.272	56.8	55.5	1.3			0.5	0.0		S.	10.0
		20	0	284	58.9	55.6	3.3	67.0		0.8	0.4	S by W.	SSW.	9.8
		22	0	287	61.6	57.1	4.5	53.2		1.0	0.8	SSW.	S by W.	9.5
July	6	0	0	306	63.0	58.0	5.0		0.184	1.4	1.0	SSW.	SSW.	9.8
		2	0	337	64.8	59.0	5.8			2.2	1.0	SW.	SW.	6.0
		4	0	406	61.8	55.3	6.5			1.7	0.5	SW by W.	SW by W.	9.8
		6	0	461	59.9	54.0	5.9			0.8	0.4	SW by W.	SW by W.	9.5
		8	0	505	55.7	52.8	2.9			1.1	0.6	SW by S.	SW.	4.0
		10	0	546	51.2	49.2	2.0			0.6	0.2	SW by S.		0.5
		18	0	29.574	47.4	46.6	0.8			0.2	0.0		SSE.	9.0
		20	0	585	55.2	53.0	2.2	66.5		0.0	0.0			9.0
		22	0	577	63.0	58.0	5.0	45.5		0.2	0.2	SSE?	SW by S : SSW.	9.0
July	7	0	0	574	61.6	56.2	5.4		0.000	0.4	0.2	SW?	S by W.	9.5
		2	0	570	66.8	59.2	7.6			0.5	0.3	SW by S.	S.	8.5
		4	0	567	65.0	58.0	7.0			0.6	0.2	SW.	S by W.	9.5
		6	0	576	57.9	56.8	1.1			0.1	0.1	NE.	SW by W : S by W.	9.8
		8	0	589	57.0	56.8	0.2			0.0	0.0		S.	9.5
		10	0	608	55.2	54.8	0.4			0.0	0.0		NW : S.	10.0
		18	0	29.628	51.9	51.0	0.9			0.0	0.0		S.	8.0
		20	0	645	58.0	55.3	2.7	67.9		0.0	0.0		SSW.	6.0
		22	0	658	61.3	56.4	4.9	47.8		0.0	0.0		SSE : S.	9.0
July	8	0	0	667	63.7	56.4	7.3		0.050	0.1	0.0		S ½ E.	9.0
		2	0	680	56.8	55.0	1.8			0.5	0.1	NNE.	ESE.	10.0
		4	0	716	55.8	54.0	1.8			0.4	0.1	NNW.	SSE.	10.0
		6	0	740	60.6	57.5	3.1			0.1	0.0		SE by S.	10.0
		8	0	769	57.9	54.2	3.7			0.2	0.1	SSE?	ESE.	9.0
		10	0	802	54.5	53.3	1.2			0.2	0.0	SSE.	ESE.	3.5
July	9	0	0	66.3 52.2	0.331	0.4				
		18	0	29.850	53.7	52.8	0.9			0.6	0.0		ENE.	10.0
		20	0	856	60.9	58.1	2.8			0.0	0.0	SW.	ENE.	8.5
		22	0	839	65.6	58.9	6.7	64.3		0.2	0.2	N by W.	N : NE?	8.5
July	10	0	0	849	63.9	55.0	8.9	51.3		0.6	0.3	NNE.		9.0
		2	0	860	63.7	56.6	7.1		0.005	0.6	0.5	NE by N.		7.5
		4	0	859	62.6	55.0	7.6			1.7	1.2	NNE.	N.	7.0
		6	0	859	60.6	55.0	5.6			1.2	0.2	NNE.		9.5
		8	0	880	58.8	53.1	5.7			0.3	0.2	N by E.	NNW : NNE : S.	9.8
		10	0	909	55.7	52.3	3.4			0.2	0.0		N.	8.0
		18	0	29.980	54.8	50.5	4.3			0.4	0.1	NNE.	NNW.	8.0
		20	0	30.008	57.0	52.1	4.9			0.7	0.3	NE by N.		9.0
		22	0	30.022	59.6	54.0	5.6	66.6		0.7	0.4	NE by N.	N by W.	9.2
July	11	0	0	30.027	61.2	54.0	7.2	53.4		0.5	0.2	NE by E?	NNW.	8.0
		2	0	30.030	63.0	55.8	7.2		0.000	0.3	0.1	ENE.	NW.	9.0
		4	0	30.020	63.0	55.8	7.2			0.3	0.3	E.	N by W.	2.5
		6	0	30.002	59.3	55.3	4.0			0.3	0.1	E by N.		0.1

SPECIES OF CLOUDS, &c.

Observer's
Initial.

- h.
8. A good deal of thunder with vivid flashes of lightning within the last hour, proceeding from a dark mass of scud to SW., W., and reaching past the zenith, the scud moving from SSW.; cirro-stratus and cirrous haze above; loose smoky scud, low from ENE.; the intervals between the lightning and the thunder changed from 20^s to about 10^s and 12^s. At 8^h 5^m. A general Scotch mist; a vivid flash of lightning with thunder at 8^h 3^m. Frequent flashes of lightning with thunder till 9^h 10^m; the storm was most violent about 8^h 40^m, the intervals being 5^s to 8^s. 9^h 10^m. Loose scud acted on by currents in every direction, moving principally from the westward; the thunder ceased till 9^h 25^m when it recommenced in the ESE.
10. Scud. The thunder still continues in the NE., frequent flashes of sheet-lightning; the thunder faint and distant. This storm commenced in the SW. and W., passed a little to the north of the zenith round towards the E. and NE.: it rained from 8^h till 9^h, occasional showers afterwards.
18. Scud + cirrous clouds and haze.
20. Id. + woolly and linear cirri and cirrous haze.
22. Scud and loose cumuli.
0. Id. + patches of cirrous clouds.
2. Loose-edged cumuli.
4. Scud and loose cumuli.
6. Id. + cumulo-strati on N. and E. horizon.
8. Cirrous scud + cumulo-strati on S. and N. horizon; cirro-strati to E.
10. Cumuli and cirro-strati to E.
18. Mottled and linear cirri + cirrous haze to E.; cirro-cumulous scud to N. and S.; portion of a solar halo.
20. Cirrous haze and linear cirri; cirro-strati to SW.; large masses of scud to W.
22. Scud and loose cumuli: woolly cirri; thick cirrous haze to E.
0. Scud, loose cumulo-strati, &c. + cirrous clouds; a few drops of rain.
2. Cirrous-edged cumuli, scud, cirri, &c.; nearly as at 0^h.
4. Scud and cumuli + cirro-stratus scud.
6. Scud: loose cumuli + cirrous clouds; raining to NE., rainbow.
8. Scud, moving very slowly + cumuli to S.; shower lately, rain to E.
10. Scud to N., very low: scud; cirrous haze.
18. Cirro-cumulous scud + patches of mottled cirri; cirro-strati to NE.
20. Masses of scud and cumuli + large cirro-cumuli and patches of woolly and mottled cirri.
22. Scud and cumuli: woolly cirri + cumulo-strati near horizon; cirrous haze.
0. Scud and cumuli + woolly cirri; sky electric-looking; rain to NW.?
2. Thunder-storm, vivid flashes of lightning and loud peals of thunder; the thunder-clouds about a mile distant: scud and heavy cumuli; beautiful pinnacled cumulo-strati to E., cirrous haze; heavy rain; storm moving off to WNW.
4. Scud and cumuli, very dark and electric to W. + cirrous clouds and linear cirri; the thunder-storm continued till 3^h, chiefly at the distance of a mile, with heavy showers.
6. Scud and cumuli + cirrous clouds; cirro-strati to E.: the quantity of rain since 1^h is 0.331 in.
8. Cirro-stratous scud + cirro-cumuli; cirro-strati on horizon; black ranges of cumulo-strati to E. and SE.
10. Loose cirro-cumuli and scud.
18. Thick cirro-cumulous mass + cirrous haze.
20. Id. id.
22. Patches of scud: cirro-cumulo-strati and cirro-cumuli + cumulo-strati to SE.
0. Thick cirro-cumulous and cirrous mass.
2. Cirro-cumulo-strati; patches of scud to S.; cumuli on SW. horizon.
4. Cirro-stratous scud, thin cirro-cumuli, and mottled cirri + cirrous haze, cirro-strati.
6. Cirro-cumulo-strati; cirro-strati.
8. Cirro-cumulous scud: large cirro-cumuli. 8^h 50^m. Fine cirro-cumulous scud from N., woolly cirro-cumuli moving slowly from N.; regularly [formed woolly cirri moving quickly from S.
10. Cirro-stratous scud, cirro-cumulo-strati.
18. Cirro-cumulo-strati, lying in strata to N. and E.; scud on Cheviot.
20. Id.
22. Scud and loose cumuli + detached masses of cumuli to E. and S.
0. Id.
2. Id.
4. Detached masses of cumuli and scud, the latter acted on by different currents.
6. Patches of clouds near horizon.

W

W

W

W

W

W

W

W

W

W

W

W

W

W

W

W

W

W

W

W

W

W

W

W

W

W

W

W

W

W

W

W

W

W

W

W

W

W

W

W

W

W

W

W

W

W

W

W

W

SPECIES OF CLOUDS, &c.

Observer's
Initial.

h.		
8.	Patches of cirrous clouds to S.	W
10.	Scud and patches of cirri.	W
18.	Thin cirrous scud + thick mass of cirrous haze and linear cirri; a few drops of rain; a strip of greenish sky to E.	B
20.	Nearly as before; broken cirrous scud; drops of rain, dark to E.	B
22.	Masses of scud + thick mass of cirrous clouds and haze and dense cirro-cumuli.	W
0.	Scud + cirrous clouds and haze.	W
2.	Id. + id.; light rain.	W
4.	Id. + id.	B
6.	Id. + id.; raining.	B
8.	Id. + id.	W
10.	Id. + thick cirro-cumulous and cirrous mass, tinged with red half an hour ago.	W
18.	Scud: cirro-cumulous scud: cirri + thick mass of cirrous haze; cumulo-strati to E.	B
20.	Haze thinner than before, more scud and cirri; upper half of a solar halo.	B
22.	Scud and cumuli + patches of cirri.	W
0.	Id., moving slowly.	W
2.	Loose scud: cirrous-edged cumuli + patches of cirri.	W
4.	Scud: cumuli.	B
6.	Three currents of scud; cumuli to SSE.	B
8.	Two currents of scud.	W
10.	Scud + cirro-cumulo-strati to S.	W
18.	Cirrous scud + a beautiful range of cumulo-strati to E. [E. and W.]	B
20.	Scud: cirrous scud + long lines of pectinated cirri, the backs or midribs lying N. and S., and the teeth	B
22.	Scud and cirrous-edged cumuli + patches of linear cirri.	W
0.	Scud and cumuli.	W
2.	Id.	W
4.	Cirrous scud + patches of linear cirri.	B
6.	Id. + id.	B
8.	Cirro-cumuli, covered and mixed with woolly cirri, waved in some places + varieties of cirri; scud to NW.	W
10.	Cirro-cumuli lying N. by E. to S. by W., tinged with red + woolly and mottled cirri.	W
18.	Detached patches of scud: sheets of loose cirro-cumuli, moving slowly + cumulo-strati on E. horizon.	B
20.	Smoky scud: dark extensive mass of cirro-stratous scud rising from W.: dense cirrous mass.	B
22.	Loose scud, moving quickly + woolly and mottled cirri.	W
0.	Id. + linear cirri and woolly cirro-cumuli.	W
2.	Loose-edged cumuli + linear and mottled cirri; cirrous haze.	W
4.	Id. + patches of cirro-cumuli.	W
6.	Cirrous scud and cumuli + patches of woolly and mottled cirri.	W
8.	Patches of cirri: cumuli, moving slowly + flounder-shaped masses of beautiful cirri.	B
10.	Strata of cirro-cumuli to N. and sheets of cirri to S.	B
18.	Scud.	W
20.	Id. + dense cirro-stratus and haze.	W
22.	Id. + id.	B
0.	Id. + id.	B
2.	Id. + id.	B
4.	Id.	W
6.	Homogeneous; light rain.	W
8.	Scud.	B
10.	Id.; rain.	B
18.	Loose scud, low and moving quickly + thick cirrous clouds and haze; patches of dark-blue clouds to E.	W
20.	Loose scud + dense cirro-stratus and haze; light rain.	W
22.	Id. + id.; light drizzle.	B

Göttingen Mean Time of Observation.			BARO- METER Corrected.	THERMOMETERS.				RAIN GAUGE.	ANEMOMETER.			Clouds moving from	Quantity of Clouds.
				Dry.	Wet.	Diff.	Max. and Min.		Pressure.		Direction of Wind.		
									Max.	Pres.			
July 18	d. h. m.		in.	°	°	°	°	in.	lbs.	lbs.			0-10.
	0 0		29.518	54.9	52.2	2.7		0.348	0.7	0.1	N by W.	NNW.	10.0
	2 0		519	62.8	57.9	4.9			0.1	0.1	SSW.	NW.	7.0
	4 0		522	62.6	56.9	5.7			0.2	0.2	ENE.	NNW.	5.0
	6 0		518	59.3	55.9	3.4			0.4	0.0		WNW.	7.3
	8 0		521	58.0	52.7	5.3			0.5	0.1	NW by W ?	S by W.	3.0
	10 0		526	52.0	48.2	3.8			0.5	0.1	W.	S by W.	1.5
	18 0		29.414	51.0	48.6	2.4			0.3	0.4	SW.	WNW : WSW.	6.0
	20 0		409	54.0	50.9	3.1			0.4	0.4	WSW.	WNW.	10.0
	22 0		431	50.0	49.4	0.6	64.2		0.4	0.1	NW ?	NW by W.	10.0
July 19	0 0		450	53.0	50.1	2.9	47.4		0.4	0.2			9.9
	2 0		441	57.9	51.8	6.1		0.098	0.2	0.1	NNE.	NNW.	7.0
	4 0		451	55.0	52.3	2.7			1.3	0.1	N by E.	NNW.	8.0
	6 0		456	55.6	52.3	3.3			0.2	0.3	NNE ?	NW.	8.0
	8 0		478	52.2	49.9	2.3			0.2	0.1	NNE.	NNW.	9.5
	10 0		490	51.0	49.7	1.3			0.1	0.0		NW.	10.0
	18 0		29.442	47.5	45.5	2.0			0.0	0.0		NW.	9.8
	20 0		359	51.3	48.5	2.8			0.4	0.2	SW.	W by S.	10.0
	22 0		373	53.6	50.6	3.0	60.9		0.6	0.4	SW.	WSW.	10.0
July 20	0 0		326	51.2	50.1	1.1	45.5		0.6	0.4	SW by S.		10.0
	2 0		259	53.8	52.2	1.6		0.292	0.7	0.2	SW.	W.	10.0
	4 0		228	55.9	53.0	2.9			1.3	0.3	SW.	W by S.	10.0
	6 0		205	56.4	53.0	3.4			0.8	0.4	SW.	W.	10.0
	8 0		213	55.1	52.0	3.1			1.2	0.8	WSW.	WNW.	9.0
	10 0		232	52.7	50.8	1.9			0.9	0.5	W by S.	NW.	7.0
	18 0		29.265	53.1	50.2	2.9			0.6	0.5	W.	NW : WNW.	10.0
	20 0		290	54.3	51.8	2.5			0.6	0.2	W.	NW.	10.0
	22 0		310	57.3	53.3	4.0	56.5		0.5	0.4	W by N.	WNW.	9.8
July 21	0 0		337	55.0	53.7	1.3	49.3		0.4	0.1	N.	NW by W.	9.8
	2 0		360	59.9	52.9	7.0		0.040	0.3	0.4	NW.	WNW.	7.5
	4 0		380	61.7	52.6	9.1			0.7	0.7	NNW.	NW by N.	3.0
	6 0		413	60.0	52.0	8.0			1.4	0.7	N.		2.5
	8 0		468	53.0	50.1	3.1			1.6	0.0			0.8
	10 0		503	50.1	47.8	2.3			0.1	0.0	NNE ?	WNW.	6.0
	18 0		29.470	47.2	46.6	0.6			0.0	0.0			9.0
	20 0		446	55.6	53.0	2.6			0.0	0.0		NW.	9.8
	22 0		421	59.8	55.3	4.5	62.4		0.6	0.5	SW.	SW.	10.0
July 22	0 0		397	63.2	58.8	4.4	42.9		0.4	0.2	SW.	WSW.	10.0
	2 0		360	60.8	57.2	3.6		0.000	0.1	0.0	SW.	WSW.	10.0
	4 0		326	59.1	57.7	1.4			0.0	0.0		WSW.	10.0
	6 0		289	58.6	57.7	0.9			0.0	0.0		W.	10.0
	8 0		251	56.8	55.3	1.5			0.1	0.1	WSW ?	W.	10.0
	10 0		208	55.9	54.2	1.7			0.1	0.0		W.	10.0
July 23	0 0		67.0	0.386	6.1	5.0	NNE.		
	18 0		29.734	51.4	48.2	3.2	46.2		4.7	0.0		WNW.	8.5
	20 0		756	52.8	49.2	3.6			0.0	0.0		WNW.	9.0
	22 0		770	54.9	48.7	6.2	57.2		0.3	0.1	W by N ?	NNW.	10.0
July 24	0 0		786	56.8	49.7	7.1	40.8		0.4	0.1	NNW ?	NNW.	10.0
	2 0		797	59.8	51.0	8.8		0.000	0.3	0.3	NNW.	NW.	9.5
	4 0		805	59.4	51.4	8.0			0.2	0.1	NNW.	WNW.	6.5
	6 0		812	60.8	51.4	9.4			0.0	0.0	NW by N ?	WNW.	8.5

July 24^d 5^h—25^d 23^h. The water having been taken out of the anemometer cistern, the force of the wind was estimated.

SPECIES OF CLOUDS, &c.

Observer's
Initial.

- | | | |
|-----|--|---|
| h. | | |
| 0. | Scud + dense cirro-stratus and haze ; light drizzle. | B |
| 2. | Cirrous-edged cumuli and scud + cumulo-strati to S. | B |
| 4. | Cumuli and cirrous scud, very low on the side of Cheviot : a large black lowering mass of scud from about W. half an hour ago. | W |
| 6. | Scud and cumuli. | W |
| 8. | Cirro-cumulous scud + cumulo-strati to SE. | B |
| 10. | Cirri and cirro-cumuli + cirro-strati to E. | B |
| 18. | Loose scud : cirro-cumuli and cirrous scud. | W |
| 20. | Scud. | W |
| 22. | Id. ; heavy rain. | B |
| 0. | Id. + cirrous clouds ; drizzle. | B |
| 2. | Scud and cumuli + cirri ; heavy rain to SE. [showers. | B |
| 4. | Scud + fine ranges of cumuli, mixed with cirrous clouds, to E ; dark and raining to SW. ; occasional | W |
| 6. | Scud and cumuli + patches of cirrous clouds ; raining heavily to SE. from a black mass of scud ; heavy shower of rain and hail lately. 6 ^h 20 ^m .
A large mass of cumuli, nimbi, and scud, covering three parts of the sky, converging to a deep black to SE. where it appears to rain heavily. | W |
| 8. | Heterogeneous scud + cumuli on E. horizon. | B |
| 10. | Scud. | B |
| 18. | Id. + cirro-stratus on E. horizon. | H |
| 20. | Id. | H |
| 22. | Id. ; light rain. | W |
| 0. | Rain. | W |
| 2. | Scud ; light rain. | W |
| 4. | Id. | W |
| 6. | Id. ; the sun's disc just visible through a dense cirrous mass. | B |
| 8. | Id. ; cirrous clouds and haze. | D |
| 10. | Id. + cirro-cumuli and cirrous clouds ; dark mass of scud to E. | W |
| 18. | Id. ; cirrous scud. | W |
| 20. | Id. ; a few drops of rain. | W |
| 22. | Cirro-strati and scud ; shower. | B |
| 0. | Scud + cirro-strati and cumuli to NE. ; showers. | B |
| 2. | Scud and cumuli + range of cumuli from WNW. to ESE. forming half of a great circle, making an angle of 8° with the N. horizon. | B |
| 4. | Cumuli, apparently acted on by several currents + cumulo-strati on horizon ; patches of mottled cirri. | W |
| 6. | Masses of cirro-cumuli and cirri + cumulo-strati on NE. and SW. horizon. | W |
| 8. | Masses of scud and cumuli to SW. ; linear cirri lying NNW. to SSE. ; cirro-strati to NE. | W |
| 10. | Cirro-cumulo-strati + linear cirri. | B |
| 18. | Cirro-cumuli and cirrous haze over the sky ; cirro-strati on NE. and E. horizon. | W |
| 20. | Sky densely covered with cirrous haze and cirro-cumuli, moving very slowly + cirro-strati to E. | W |
| 22. | Scud + cirro-cumuli and cirrous haze. | B |
| 0. | Id. + id. ; drops of rain. | B |
| 2. | Id. ; light shower. | B |
| 4. | Id. ; rather heavy rain. | W |
| 6. | Id. ; id. | W |
| 8. | Id. ; light rain ; clouds breaking. | B |
| 10. | Id. | B |
| 18. | Woolly cirro-cumuli + cirro-strati to E. | B |
| 20. | Id. + cumulo-strati to N. ; cirrous haze to W. and NW. | B |
| 22. | Scud and loose cumuli. | W |
| 0. | Scud and cumuli. | W |
| 2. | Id. | W |
| 4. | Cirro-cumuluous scud and cumuli. | B |
| 6. | Id. | B |

Göttingen Mean Time of Observation.			BARO- METER Corrected.	THERMOMETERS.				RAIN GAUGE.	ANEMOMETER.			Clouds moving from	Quan- tity of Clouds.
				Dry.	Wet.	Diff.	Max. and Min.		Pressure.		Direction of Wind.		
									Max.	Pres.			
July 24	d. 8 h. 0 m. 10	29-845 869	55.4 52.0	52.0 48.7	3.4 3.3		in.	lbs. 0.2 0.0	lbs. 0.1 0.0	NNE ?	WNW. NW.	0-10. 6.0 8.0	
	18 0 20 0 22 0	29-931 938 944	43.3 52.9 60.7	42.8 51.5 55.2	0.5 1.4 5.5			0.0 0.0 0.0	0.0 0.0 0.0		NNW. NW. NW.	1.5 6.5 9.0	
July 25	0 0 2 0 4 0 6 0 8 0 10 0	954 947 943 941 950 952	63.7 64.7 66.0 64.8 61.0 57.0	58.1 59.6 60.0 60.1 56.7 55.0	5.6 5.1 6.0 4.7 4.3 2.0		0.000	0.0 0.0 0.0 0.0 0.0 0.0	0.0 0.2 0.0 0.2 0.0 0.0	W. SSW.	NW. WNW. WNW. WNW. NW.	9.0 10.0 10.0 10.0 10.0 8.0	
	18 0 20 0 22 0	29-910 908 883	57.4 61.0 65.5	56.3 59.0 62.7	1.1 2.0 2.8			0.0 0.0 0.0	0.2 0.1 0.3	SW. SW by W ? SSW.		10.0 10.0 10.0	
July 26	0 0 2 0 4 0 6 0 8 0 10 0	858 831 800 780 762 735	65.6 66.7 65.3 64.2 62.4 59.5	62.5 63.4 62.8 61.2 60.0 57.3	3.1 3.3 2.5 3.0 2.4 2.2		0.005	0.7 1.4 1.7 1.9 1.3 1.3	0.7 0.8 1.3 0.6 0.3 0.4	SW by S. SSW. SW. SW by S. SW by S. SW by S.	WSW. WSW. WSW. WSW. WSW. W by S.	10.0 10.0 10.0 10.0 10.0 10.0	
	18 0 20 0 22 0	29-738 732 721	51.5 56.1 61.3	49.5 52.3 55.2	2.0 3.8 6.1			1.4 0.6 1.2	0.1 0.2 1.2	W by S. SW by W. WSW.	WNW ? : WSW. WNW. W : W by N.	1.5 1.0 9.0	
July 27	0 0 2 0 4 0 6 40 8 0 10 0	715 702 702 699 732 745	63.3 64.1 61.8 60.0 57.7 54.6	55.8 55.8 54.2 55.0 51.8 52.3	7.5 8.3 7.6 5.0 5.9 2.3		0.007	1.2 1.9 2.3 1.3 1.1 0.7	0.6 1.5 1.8 0.2 0.8 0.0	W by S. W by N. W. v. W. NNW.	W. W. W by N. NW. NW by N. NW.	8.0 7.0 2.0 10.0 9.8 8.0	
	18 0	29-770	51.2	50.9	0.3			0.0	0.0		W.	10.0	
	20 0 22 0	774 760	54.8 59.0	52.9 55.5	1.9 3.5			0.0 0.0	0.0 0.0		SSW : NW. WSW : NNW.	9.0 9.5	
July 28	0 0 2 0 4 0 6 0 8 0 10 0	725 695 656 624 579 518	64.1 59.9 58.9 53.0 53.4 52.9	58.6 54.7 54.0 52.3 51.9 51.6	5.5 5.2 4.9 0.7 1.5 1.3		0.056	0.1 0.4 0.7 0.4 0.2 0.1	0.1 0.2 0.4 0.1 0.0 0.0	SSW. SW by S. SSW. SSW.	WSW : NW. SW : NW. SSW ? : N ? SSW.	10.0 10.0 10.0 10.0 10.0 10.0	
	18 0 20 0 22 0	29-328 281 242	54.0 60.8 63.0	53.0 58.0 57.6	1.0 2.8 5.4			0.2 0.1 1.6	0.1 0.3 0.7	SSW. SSW. SW by S.	W by S : SW. SW : WSW. S by W.	9.8 8.0 9.5	
July 29	0 0 2 0 4 0 6 0 8 0 10 0	217 173 158 135 142 160	65.0 61.3 57.3 58.7 55.0 53.8	59.4 59.4 55.0 54.2 53.2 51.0	5.6 4.4 2.3 4.5 1.8 2.8		0.074	1.3 1.9 0.9 0.3 0.6 0.2	0.7 0.5 0.3 0.5 0.0 0.0	SW by S. SW by S. SW. SW. SW by W.	WSW. SW : W by S. WSW ? W by S. W. W.	9.5 10.0 10.0 9.8 9.0 9.5	
July 30	0 0			0.6					
	18 0	29-513	52.0	50.5	1.5			1.7	0.0		NNW : NW.	7.0	

SPECIES OF CLOUDS, &c.

Observer's
Initial.

- h.
8. Cirro-cumulous scud and cumuli. W
10. Dark lowering masses of scud have moved up, at first deeply tinged with red near the horizon. W
18. Linear and woolly cirri + patches of cirro-cumulous scud to N. and SW.; cirro-strati to E. B
20. Cirro-cumulo-strati + linear cirri to N. B
22. Id. + detached masses of cumuli to N. and E.; dense cirrous haze. W
0. Scud and cumuli, moving very slowly + cirrous haze. W
2. Id. + id. W
4. Scud + cirrous haze. W
6. Id. W
8. Id. W
10. Cirro-cumulo-strati. W
18. Homogeneous. B
20. Id. B
22. Scud + dense cirro-stratus and haze. W
0. Id. + id. W
2. Id. + id. W
4. Id. + id., and thick cirro-cumuli. B
6. Id. + id. B
8. Id. + id. W
10. Id. + cirrous haze; thin cirro-cumuli; clouds to E. slightly tinged with red. W
18. Scud to W.: patches of cirro-cumuli + mass of linear cirri and cirrous haze, fringed with curled cirri; cirro-strati to E.; watery cumuli on B
20. Scud + a few patches of linear cirri and cirro-strati to E. [Cheviot. B
22. Scud and cumuli: cirrous scud + detached masses of cumuli on N. and E. horizon. W
0. Id. + patches of cirri. W
2. Id. + id.; cirro-cumuli. W
4. Cirro-cumulous scud + cumuli round horizon; rain to E. B
6. Thick masses of scud + cirrous scud; passing shower; cumulo-strati on horizon. W
8. Dark scud + cumuli; shower. 8^h 10^m. A complete double rainbow. W
10. Scud + cirrous haze to W. W
18. Ragged and cirro-cumulous scud, and cirro-cumuli + linear cirri and cirrous haze to E., fringed with curled cirri; cirro-strati; clouds on Cheviot; about 4° of a solar halo visible, being at the southern extremity of the horizontal diameter; in the midst of it is a parhelion about 1° in diameter shewing prismatic colours, this is in interlaced linear cirri. 13^h 30^m. The lowest scud from SSW., the upper cirro-cumulous scud from W. B
20. Scud: woolly cirro-cumuli, becoming haze near horizon and thick and ribbed to E.; sky in zenith; portion of a colourless halo visible? B
22. Masses of scud: large cirro-cumuli + thick cirrous haze to E. W
0. Scud: cirro-cumulo-strati. W
2. Masses of scud: dense mass of cirro-cumuli and cirrous haze. W
4. Patches of scud to S.: dense mass of heterogeneous cirri, moving very slowly. B
6. Id.: id.; light rain. B
8. Scud + dense cirrous haze. W
10. Homogeneous scud. W
18. Cirrous and cirro-cumulous scud: woolly cirro-cumuli. [0·8 lbs. B
20. Scud, moving rapidly: cirrous scud and cirrous-edged cumuli. 20^h 10^m. The wind commenced blowing B
22. Scud and cumuli + beautiful ranges of cumuli to E.; cirro-strati to E. W
0. Scud. W
2. Two currents of scud; dense cirro-stratus and haze. W
4. Scud; heavy showers. B
6. Scud and cumuli + cirrous clouds to E. W
8. Scud + patches of cirro-cumuli and mottled cirri, and cirrous haze; a double rainbow lately. W
10. Scud. W
18. Id.: cirrous scud + cumulo-strati on N. horizon. W

Göttingen Mean Time of Observation.			BARO- METER Corrected.	THERMOMETERS.				RAIN GAUGE.	ANEMOMETER.			Clouds moving from	Quantity of Clouds.
				Dry.	Wet.	Diff.	Max. and Min.		Pressure.		Direction of Wind.		
									Max.	Pres.			
July 30	d. h. m.		in.	°	°	°	°	in.	lbs.	lbs.			1-10.
	20	0	29.546	56.6	53.9	2.7	66.0		0.0	0.0		NW.	9.8
	22	0	567	58.2	52.3	5.9	66.0		0.2	0.0		W by N.	8.5
July 31	0	0	584	59.7	55.7	4.0	50.5	0.193	0.0	0.0		WNW.	9.9
	2	0	581	66.1	59.7	6.4			0.0	0.0		WNW.	8.0
	4	0	575	64.0	56.0	8.0			0.9	0.7	NW by W.		10.0
	6	0	576	60.0	54.2	5.8			0.9	0.3	W.	W by N.	10.0
	8	0	594	55.9	51.9	4.0			0.5	0.1	W by N?	NW by W : NNW.	9.0
	10	0	605	53.8	50.3	3.5			0.2	0.0	SW by W?	WNW?	10.0
	18	0	29.528	52.4	50.7	1.7			0.4	0.0		W by S.	10.0
	20	0	508	54.6	52.3	2.3	68.0		0.7	0.5	SW by W.	SW by W.	10.0
	22	0	503	56.2	54.4	1.8	50.4		1.4	0.9	SW by W.	SW by W.	10.0
Aug. 1	0	0	490	58.8	56.4	2.4		0.121	1.8	1.2	SW.	SW by W.	10.0
	2	0	496	61.0	58.0	3.0			2.3	0.6	SW.	SW.	10.0
	4	0	494	59.0	56.9	2.1			1.6	1.2	SW.	SW by S.	10.0
	6	0	491	59.1	56.7	2.4			1.4	0.2	WSW.	SW.	10.0
	8	0	477	57.7	55.3	2.4			1.3	0.4	SW.	SW.	10.0
	10	0	472	55.8	54.4	1.4			1.3	0.3	SW.	SW.	10.0
	18	0	29.352	54.3	52.7	1.6			0.9	0.0		SW.	10.0
	20	0	334	56.5	54.0	2.5	62.4		0.4	0.0	S by E?	SW.	10.0
	22	0	304	57.8	55.0	2.8	52.4		1.0	1.0	S by W.	SSW.	10.0
Aug. 2	0	0	270	60.8	57.5	3.3		0.026	1.1	0.7	S by W.	SSW.	10.0
	2	0	238	60.4	56.8	3.6			1.5	0.7	S.	SSW.	10.0
	4	0	197	63.0	59.0	4.0			1.2	0.4	S.	S by W.	10.0
	6	0	149	63.7	58.9	4.8			1.1	2.2	SSW.	S by W.	9.3
	8	0	176	56.3	54.4	1.9			2.1	0.2	SSW.	SW : SSW.	2.0
	10	0	165	55.1	53.3	1.8			0.0	0.0		SSW?	8.0
	18	0	29.103	54.4	53.8	0.6			0.0	0.0		SW.	9.5
	20	0	115	57.0	56.0	1.0	66.3		0.0	0.0		SW.	9.0
	22	0	126	62.9	58.8	4.1	51.2		1.0	0.7	SW.	SW : SW by S : S by W.	8.5
Aug. 3	0	0	129	65.3	59.4	5.9		0.068	0.9	0.8	SW.	SW : SW.	8.0
	2	0	121	65.6	58.9	6.7			1.1	0.6	SW.	SW.	7.0
	4	0	130	66.0	58.3	7.7			1.2	0.3	W?	SW.	6.5
	6	0	136	61.0	56.6	4.4			0.7	0.0		SW.	6.0
	8	0	141	55.3	53.8	1.5			0.2	0.0		NNW.	6.0
	10	0	145	52.3	51.7	0.6			0.0	0.0		W?	5.5
	18	0	29.132	52.3	51.3	1.0			0.0	0.0		W by N.	10.0
	20	0	145	58.0	56.0	2.0	68.2		0.0	0.0		W.	9.8
	22	0	152	62.3	58.3	4.0	49.0		0.1	0.0		W.	8.0
Aug. 4	0	0	155	66.9	59.7	7.2		0.004	0.0	0.0		W by S.	9.0
	2	0	184	61.0	56.3	4.7			0.2	0.1	N.	NNW.	9.3
	4	0	197	64.0	59.0	5.0			0.0	0.0		NW.	4.0
	6	0	228	57.1	55.9	1.2			0.1	0.0		WNW.	10.0
	8	0	257	57.3	56.6	0.7			0.0	0.0		WNW.	8.0
	10	0	275	55.6	54.8	0.8			0.0	0.0		W by N.	7.0
	18	0	29.411	50.6	48.4	2.2			0.4	0.1	SW.		0.5
	20	0	434	54.6	50.8	3.8	69.0		0.4	0.3	SW.	W : W by N.	0.5
	22	0	444	59.0	52.9	6.1	46.2		0.7	0.5	SW by W.	W by N : WNW?	5.5
Aug. 5	0	0	458	62.0	55.0	7.0		0.150	0.8	0.2	SW by W.	WSW.	9.0
	2	0	455	63.1	56.0	7.1			1.1	0.8	SW by W.	WSW.	9.7
	4	0	447	63.1	56.6	6.5			1.4	1.1	SW by S.	WSW : W by S.	8.0
	6	0	432	57.8	53.0	4.8			1.9	0.7	SW.	SW.	10.0

SPECIES OF CLOUDS, &c.

Observer's
Initial.

- h.
20. Scud. W
22. Cirrous scud and cirrous-edged cumuli. B
0. Scud. B
2. Cirrous scud + masses of curled and flame-cirri, pointing from N. B
4. Cumuli to E. and S.; cirrous haze and linear cirri. W
6. Scud + dense cirrous mass. B
8. Patches of scud: sky nearly covered with cirrous haze and linear cirri, dense to W., whence branch off fine parallel cirri; beautifully mottled and papillose cirri-like strings and masses of beads. B
10. Scud + cirrous haze. B
18. Id. W
20. Id. + dense cirrous clouds and haze. W
22. Id. + id.; heavy rain. B
0. Id. + id.; light rain. B
2. Thick mass of scud in ranges + loose cirro-cumuli; occasional patches of sky. B
4. Scud. W
6. Id. + cirro-strati to NE. W
8. Id. + cirrous mass. B
10. Id. + id. B
18. Id. + dense cirro-stratus and haze. W
20. Id. + id. W
22. Id. + id.; light rain. B
0. Id. + id.; id. B
2. Id. + id.; id. B
4. Id. W
6. Scud and cumuli + cumulo-strati on E. horizon. [wind lately. W
8. Patches of scud: moist-looking cirro-cumuli and woolly cirri + sheets of cirro-strati; heavy showers with B
10. Scud, cirro-cumulous scud. B
18. Thin scud + thick cirro-cumulous and cirrous mass; openings to SW. and N.; light rain. W
20. Scud, cirro-cumulous scud + thick cirrous mass to N. and E.; woolly cirri to SW.; loose cumuli on N. and W
22. Cumuli and scud: cirrous scud: woolly cirri + ranges of cumuli near horizon. [S. horizon. B
0. Ranges of cumuli: cirrous scud, woolly cirri + cumulo-strati to N. B
2. Loose scud and ranges of cumuli + woolly cirri and cirrous haze to E. W
4. Scud and cumuli + sheets of woolly cirri. B
6. Id.; the scud, thin below; cumuli in ranges and near the horizon, mixed with cirro-strati; to the NE. ragged castellated cumuli; varieties of cirri; a few drops of rain. W
8. Thick masses of woolly and brush cirri to W. moving slowly + white cumuli, nimbi, and cumulo-strati. B
10. Scud + cirri. B
18. Scud, moving slowly. W
20. Cirrous scud, moving slowly; slight shower. W
22. Woolly cirri or cirrous scud + piles of cumuli near horizon. B
0. Cirrous scud and cumuli; showers around. [peals of thunder. B
2. Thick scud + piles of cumuli on horizon; cirrous clouds and cumuli; heavy shower; one or two faint W
4. Cirrous scud + piles of cumuli all round the horizon. W
6. Scud; misty to N., E., and S.; electric-looking to W.; heavy shower. W
8. Id. + cirrous scud; masses of loose scud lying low on Cheviot. W
10. Id. B
18. Masses of scud near the horizon. W
20. Patches of loose scud: masses of thin cirro-cumulous scud. W
22. Cirrous scud: sheets of woolly cirri + ragged cumuli on horizon. B
0. Scud + ragged cumuli on horizon. B
2. Id. + id. B
4. Masses of cumuli: cirro-cumuli, undulated to S. W
6. Scud + cirrous clouds, cirro-strati to E.; light rain. W

Göttingen Mean Time of Observation.			BARO- METER Corrected.	THERMOMETERS.				RAIN GAUGE.	ANEMOMETER.			Clouds moving from	Quan- tity of Clouds.
				Dry.	Wet.	Diff.	Max. and Min.		Pressure.		Direction of Wind.		
									Max.	Pres.			
Aug. 5	d. h. m.		in.	°	°	°	°	in.	lbs.	lbs.			0-10.
5	8 0		29.400	56.3	53.2	3.1			2.7	1.6	SW.	SW : WSW.	9.0
	10 0		395	52.8	49.0	3.8			3.2	0.6	WSW.	SW ?	0.8
Aug. 6	0 0				1.4				
	18 0		29.878	49.2	47.2	2.0			2.2	0.0		NW by N.	9.0
	20 0		884	53.9	51.7	2.2			0.1	0.0	SW by W ?		9.5
	22 0		866	62.4	58.1	4.3	64.9		0.0	0.0			10.0
Aug. 7	0 0		841	61.8	58.7	3.1	44.1		0.3	0.2	S ?	SW ?	10.0
	2 0		805	59.2	56.9	2.3		0.060	0.8	0.4	S by W.	SSW.	10.0
	4 0		766	60.7	57.8	2.9			1.5	0.5	SSW.	SSW : WSW.	9.8
	6 0		745	59.3	58.3	1.0			0.5	0.1	SW by S.	SW.	10.0
	8 0		766	61.5	60.2	1.3			0.6	0.6	SW.	WSW : W.	9.8
	10 0		803	61.5	60.5	1.0			0.3	0.0		WSW ?	10.0
	18 0		29.862	57.7	57.7	0.0			0.1	0.0		SW ?	10.0
	20 0		882	57.7	57.7	0.0	65.1		0.0	0.0			10.0
	22 0		870	60.8	60.1	0.7	56.3		0.0	0.0			10.0
Aug. 8	0 7		854	64.3	63.5	0.8		0.171	0.0	0.0		SW by S.	10.0
	2 0		842	68.6	65.0	3.6			0.4	0.0	SW.	SW.	10.0
	4 0		822	66.0	62.6	3.4			1.5	0.1	SW by S.	SW by S.	9.8
	6 0		798	64.3	61.3	3.0			1.5	0.8	SW by S.	SW by S : SSW.	9.8
	8 0		811	57.0	56.8	0.2			1.3	0.0			10.0
	10 0		827	56.5	56.0	0.5			0.0	0.0			9.8
	18 0		29.857	53.2	52.0	1.2			0.0	0.0		SW by S.	9.0
	20 0		869	56.8	53.0	3.8	70.2		0.0	0.0		SW by S.	7.0
	22 0		879	58.8	54.9	3.9	52.1		0.0	0.0		WNW.	3.0
Aug. 9	0 0		879	62.3	56.3	6.0		0.067	0.0	0.0		WNW : SSW.	5.0
	2 0		880	65.2	57.0	8.2			0.0	0.0		WNW : SW.	4.0
	4 0		857	66.3	56.3	10.0			0.0	0.0		W.	4.0
	6 0		846	63.2	56.7	6.5			0.1	0.0		W by S : SW.	3.5
	8 0		863	58.3	56.0	2.3			0.1	0.1	NNE.	WNW : SSW.	4.0
	10 0		886	53.5	52.3	1.2			0.0	0.0	NNE.		7.0
	18 0		29.882	47.2	46.6	0.6			0.0	0.0		NNE.	0.8
	20 20		903	57.3	55.0	2.3	69.5		0.0	0.0		NE by E : NNE.	8.5
	22 0		916	58.6	54.7	3.9	43.9		0.0	0.0		N by E.	3.5
Aug. 10	0 0		926	62.2	55.6	6.6		0.000	0.2	0.1	NE by E ?	NNE.	4.0
	2 0		937	63.1	56.1	7.0			0.2	0.1	ENE.	NNE.	4.0
	4 0		934	63.1	54.9	8.2			0.2	0.1	ENE.	N by W.	1.8
	6 0		936	61.9	54.1	7.8			0.1	0.0			0.5
	8 0		949	56.8	53.6	3.2			0.0	0.0		SE : NW.	2.0
	10 0		973	53.1	52.1	1.0			0.0	0.0		WSW.	3.0
	18 0		29.986	50.4	49.7	0.7			0.0	0.0		NNW : NNW.	9.5
	20 0		29.987	55.2	54.0	1.2	65.2		0.0	0.0		NNW.	10.0
	22 0		29.984	63.7	58.8	4.9	45.2		0.3	0.1	SW.	W ?	9.0
Aug. 11	0 0		30.000	66.0	60.8	5.2		0.000	0.7	0.3	SSW.	W.	10.0
	2 0		30.006	68.1	62.1	6.0			0.5	0.2	SSW.	W by S.	10.0
	4 0		29.990	66.4	61.2	5.2			0.2	0.1	SSW.	W by S : NNW.	9.9
	6 0		29.991	64.6	59.9	4.7			0.4	0.1	SW by S.	WSW.	9.0
	8 0		30.004	61.0	58.6	2.4			0.2	0.0		W by S : NNW.	9.5
	10 0		30.007	55.9	55.0	0.9			0.0	0.0			3.0

SPECIES OF CLOUDS, &c.	Observer's Initial.
h. 8. Patches of scud : scud + masses of cirri, cirro-strati to E.	B
10. Id. + cirro-strati to N. and S.	B
18. Linear, woolly, and mottled cirri + cirro-cumuli.	B
20. Linear cirri and cirrous haze.	W
22. Patches of scud on E. and S. horizon ; dense mass of cirro-stratus.	W
0. Masses of scud + thick cirrous haze ; light rain.	W
2. Scud + id ; a few drops of rain.	B
4. Smoky scud : cirrous scud + woolly cirri ; clouds breaking.	B
6. Homogeneous scud ; occasional showers.	W
8. Two currents of scud.	W
10. Scud ; occasional showers.	B
18. Scud, nearly homogeneous ; light rain, mist.	B
20. Id., id. ; id., id.	B
22. Homogeneous scud ; rain till 21 ^h 45 ^m .	W
0. Two currents of scud + cirrous haze.	W
2. Scud ; raining towards Cheviot.	W
4. Id. + cirrous clouds.	B
6. Scud, hanging in ragged curtains and dropping rain, moving quickly + cirrous clouds.	B
8. Thin scud, cirrous clouds ; showers ; scud low on Cheviot.	W
10. Scud ; cirrous clouds.	W
18. Woolly cirro-cumuli and cirro-cumulo-strati.	B
20. Id. + cirro-strati and linear cirri to NW.	B
22. Scud and loose cumuli + cirro-strati to E. and W. ; patches of mottled cirri.	W
0. Cirrous-edged cumuli, moving very slowly, apparently acted on by different currents : feathered linear cirri to W. pointing from SSW. + cirro- [strati to SE.	W
2. Cirrous-edged cumuli, as before : masses of cirro-cumuli, rather large at the middle and getting gradually smaller, till at the edges they become small points almost indistinguishable from haze, the cirro-cumuli move faster than the cumuli + cirro-strati and haze to SE.	W
4. Ragged-edged cumuli from W., the edges near the zenith breaking into zigzag cirrous fragments, which move in various directions + woolly cirri ; hazy to E.	B
6. Ragged-edged cumuli as before : linear cirri, cirro-cumuli of all sizes, small cumulo-strati, &c. + cumulo-strati ; cirrous haze to E.	B
8. Cumuli and scud : beautiful ranges of cirro-cumuli to E., flame-cirri in zenith, mottled cirri to W. all lying from SSW to NNE.	W
10. Cirro-cumuli, cirro-strati, and cirrous haze.	W
18. Loose cumuli, the edges broken into patches which dissipate + thick mass of linear cirri to E., range of small cumuli to NNE., heavy mist on the ground.	B
20. Two currents of scud.	B
22. Cirrous-edged cumuli + patches of cirri.	W
0. Id. and scud.	W
2. Id.	W
4. Ragged-edged cumuli, in ranges on S. horizon.	B
6. Cumuli on S. horizon.	W
8. Scud to S. and W. : flame-cirri to W. + cumuli on S. horizon.	W
10. Cirro-cumulo-strati ; a streak of hazy cirrus moving across the face of the moon.	W
18. Cirro-cumulous scud : cirrous clouds over the sky, in uniform sheets having a sort of stratified form point- ing from NNW. to SSE., the lowest portions of it becoming cirro-cumulous at the edges.	B
20. Patches of scud + homogeneous cirrous mass through which the sun is seen like a bright spot one-half his diameter : a bright strip to E.	B
22. Linear cirri and cirrous haze + cirro-strati near horizon ; patches of scud.	W
0. Scud, moving slowly + thick cirrous haze.	W
2. Id. id.	W
4. Scud : a dense mass of cirro-cumuli, moving slowly + linear cirri and cirrous haze.	W
6. Scud.	W
8. Cirro-cumulous scud : flame and linear cirri + cirro-strati to W.	W
10. Cirro-cumulous scud, cirrous clouds and haze all deeply tinged with red at 9 ^h ; patches of cirro-cumuli.	W

Göttingen Mean Time of Observation.			BARO- METER Corrected.	THERMOMETERS.				RAIN GAUGE.	ANEMOMETER.			Clouds moving from	Quantity of Clouds.
				Dry.	Wet.	Diff.	Max. and Min.		Pressure.		Direction of Wind.		
									Max.	Pres.			
Aug. 11	18	0	30.023	49.1	49.0	0.1		0.0	0.0			0-10.	
	20	0	028	56.6	55.2	1.4		0.2	0.1	SW by S.	SW by S.	0.1	
	22	0	024	61.6	58.4	3.2	68.9	0.6	0.2	SW.		1.0	
Aug. 12	0	0	011	66.0	62.0	4.0	47.7	0.4	0.2	SW by S.	W by S.	0.5	
	2	0	011	70.0	64.9	5.1		0.4	0.2	SW by S.	W by S : WSW.	4.0	
	4	0	011	70.9	64.3	6.6		0.6	0.2	SW by S.	W.	4.0	
	6	0	008	67.0	63.0	4.0		0.4	0.0		NW by W : W by N.	3.0	
	8	0	026	60.9	59.3	1.6		0.3	0.0		W by S ?	3.5	
	10	0	048	59.0	58.1	0.9		0.0	0.0		SW.	3.0	
Aug. 13	0	0	71.5						
							47.4						
	18	0	29.908	48.0	47.1	0.9		0.3	0.0		W : SSE.	3.0	
	20	0	910	53.9	52.9	1.0		0.0	0.0			0.3	
	22	0	895	64.1	58.1	6.0	75.3	0.4	0.3	S.	SE ?	0.5	
Aug. 14	0	0	891	67.7	59.8	7.9	43.3	0.9	0.5	S.	S ?	0.5	
	2	0	870	70.2	62.3	7.9		1.0	0.4	SSE.	S and SSE.	2.0	
	4	0	862	69.1	61.7	7.4		0.5	0.2	SSE.	S.	6.5	
	6	0	865	64.7	59.6	5.1		0.3	0.1	SE.	S.	6.0	
	8	0	869	57.4	55.4	2.0		0.3	0.0		SSW ?	6.5	
	10	0	875	53.2	52.3	0.9		0.0	0.0		SSW ?	4.0	
	18	0	29.835	54.0	53.4	0.6		0.0	0.0		NE by N.	9.0	
	20	0	830	57.8	56.5	1.3		0.2	0.2	NE by E.	ENE.	10.0	
	22	0	831	60.9	58.3	2.6	70.8	0.2	0.1	NE.	NE by E : SE.	9.0	
Aug. 15	0	0	838	58.9	58.2	0.7	49.4	0.1	0.0	NNE ?	SE by E.	9.8	
	2	0	824	60.8	58.7	2.1		0.4	0.3	NE.	NE : SE by E : ESE.	9.0	
	4	0	811	61.6	59.5	2.1		0.8	0.6	ENE.	NE : S.	10.0	
	6	0	793	61.0	59.0	2.0		0.4	0.2	NE.	NE.	10.0	
	8	0	816	59.0	58.0	1.0		0.3	0.1	NE by N.		10.0	
	10	0	835	58.7	58.2	0.5		0.2	0.0			10.0	
	18	0	29.852	57.2	57.0	0.2		0.0	0.0			10.0	
	20	0	865	57.9	57.2	0.7	63.6	0.0	0.0			10.0	
	22	0	879	60.4	59.2	1.2	55.7	0.0	0.0			10.0	
Aug. 16	0	0	887	64.7	62.0	2.7		0.0	0.0			10.0	
	2	0	863	67.8	64.0	3.8		0.0	0.0			0.3	
	4	0	851	69.0	64.7	4.3		0.2	0.2	NE by E.		0.3	
	6	0	846	65.0	62.9	2.1		0.3	0.0			0.1	
	8	0	863	60.3	59.8	0.5		0.2	0.0	NE.	NE.	10.0	
	10	0	868	59.6	59.3	0.3		0.0	0.0			10.0	
	18	0	29.873	56.4	55.9	0.5		0.0	0.0			10.0	
	20	0	888	59.0	58.6	0.4	71.2	0.0	0.0			10.0	
	22	0	894	64.1	62.5	1.6	54.9	0.0	0.0		SSW : NNW ?	5.0	
Aug. 17	0	0	888	72.0	68.6	3.4		0.0	0.0	.		1.8
	2	0	885	68.4	67.1	1.3		0.5	0.0		SSW.	9.0	
	4	0	884	73.0	67.9	5.1		0.0	0.0	WSW.	SW.	7.0	
	6	0	884	71.3	67.8	3.5		0.1	0.0	NE.	SW : WNW.	9.0	
	8	0	907	66.0	65.0	1.0		0.0	0.0		SW ?	4.0	
	10	0	921	60.2	60.2	0.0		0.0	0.0			2.0	
	18	0	29.915	54.1	53.6	0.5		0.0	0.0		SSW.	6.5	
	20	0	925	59.0	57.6	1.4	77.1	0.0	0.0		SSW.	7.0	
	22	0	912	64.7	60.7	4.0	51.5	0.0	0.0			0.1	

SPECIES OF CLOUDS, &c.

Observer's
Initial.

- h.
18. A patch of mottled cirrus to NW. ; very hazy round horizon ; heavy dew. B
20. Scud + streaks of linear cirri to W. ; hazy on horizon. B
22. Patches of clouds near horizon, loose cumuli on S. horizon, cirrous haze to NW. W
0. Patches of scud + linear cirri to NW. ; cumuli on N. horizon ; cirrous haze round the horizon. W
2. Loose-edged cumuli : woolly cirri. W
4. Mottled, linear, hazy, and diffuse cirri + ranges of cumuli on horizon. B
6. Scud : cirri, nearly as before. B
8. Scud, moving very slowly. W
10. Scud. W
18. Loose scud to S. : large cirro-cumuli. W
20. Patches of cirro-cumuli. W
22. Patches of cirri, moving slowly + cirro-strati and haze near horizon. B
0. Small patches of scud, increasing + cirri. B
2. Ragged-edged cumuli + mottled cirri and cirrous haze. B
4. Large cirro-cumuli + cumuli and scud on E. horizon. W
6. Cirro-cumuli + linear cirri and cirrous haze ; a bank of scud and loose cumuli on E. horizon. W
8. Varieties of cirri, lying in patches and sheets in all directions + cirro-strati, the edges breaking into cirro- B
10. Loose cirro-cumuli + cirrous haze, cirro-strati. [cumuli. B
18. Thin smoky scud + dense scud on E. horizon ; cirro-cumuli and mottled cirri. W
20. Scud. W
22. Two currents of scud. [cirrous haze. B
0. Scud ; heavy rain since last observation from the lowest scud, just ceased, that current having disappeared ; B
2. Thin smoky scud : cirrous scud : woolly cirri ; heavy showers. B
4. Id., homogeneous : woolly cirro-cumuli seen at 3^h 30^m. W
6. Scud, nearly homogeneous. W
8. Id., id. W
10. Homogeneous. W
18. Homogeneous, misty. W
20. Id., id. W
22. Id., id. B
0. Id., id. B
2. Pinnacle-cumuli to S. ; hazy on horizon. The clouds broke up at 1^h. B
4. Id., id. W
6. Patches of clouds to S. ; haze on horizon. W
8. Scud and mist came on rapidly about 7^h. B
10. Very thick mist. B
18. Thick mist. W
20. Id. W
22. Scud : patches of cirri ; the clouds have just broken, the mist clearing off. B
0. Cauliflower and pinnacle-cumuli round the horizon except to NE. ; a few patches of linear and radiated cirri. The vane still points NE. About 1^h the cumuli to the W. began to break in cirrous edges, while patches of scud came up from S. or SW., the temperature having risen to 76° at 1^h 20^m ; at 1^h 45^m the sky became nearly covered with scud and nimbi, and rain began to fall ; the wind also rose, blowing from WSW ; the temperature fell to 69°. B
2. Scud, pinnacle and ragged cumuli and nimbi ; light rain, heavy to NE. 3^h. Several peals of thunder from NE. and E., distant. B
4. Cirrous-edged, piled, and cauliflower cumuli, broken into cirrous scud + linear cirri and cirrous haze. W
6. Scud : cirro-cumuli + piles of cumuli on horizon in a sort of haze ; electric-looking. W
8. Loose and pinnacle-cumuli + linear cirri, cirrous haze round horizon ; light mist falling. B
10. Linear cirri ; mist. B
18. Scud + cirro-cumulo-strati to W. and NW. ; heavy dew. W
20. Id. W
22. Id. B

Göttingen Mean Time of Observation.			BARO- METER Corrected.	THERMOMETERS.				RAIN GAUGE.	ANEMOMETER.			Clouds moving from	Quan- tity of Clouds.
				Dry.	Wet.	Diff.	Max. and Min.		Pressure.		Direction of Wind.		
									Max.	Pres.			
Aug. 18	d. h. m.		in.	°	°	°	°	in.	lbs.	lbs.			0-10.
	0 0		29.893	70.1	66.4	3.7		0.032	0.0	0.0		SSW ?	2.0
	2 0		872	74.2	67.3	6.9			0.0	0.0		SE and SW.	2.5
	4 0		849	75.6	68.0	7.6			0.1	0.0	E.	SSW.	1.5
	6 0		825	72.4	65.6	6.8			0.2	0.1	SE by S.	S by W.	6.0
	8 0		828	66.6	63.9	2.7			0.1	0.0	SSE.		9.0
	10 0		823	63.0	61.0	2.0			0.0	0.0			10.0
	18 0		29.744	54.6	54.0	0.6			0.0	0.0			10.0 ?
	20 0		727	57.6	57.0	0.6			0.0	0.0			10.0 ?
	22 0		704	64.9	63.0	1.9	78.7		0.0	0.0			0.0
Aug. 19	0 0		675	72.6	67.4	5.2	52.1	0.000	0.0	0.0	SE by S.	S.	0.5
	2 0		636	76.0	66.0	10.0			0.2	0.1	SSE.	S.	2.0
	4 0		592	77.1	66.5	10.6			0.2	0.0		SW by S.	3.0
	6 0		553	74.6	66.0	8.6			0.3	0.1	SSE.		0.2
	8 0		543	69.0	64.9	4.1			0.1	0.0	SSE.		1.0
	10 0		521	64.9	62.0	2.9			0.1	0.0	SSE.		0.3
Aug. 20	23 15		29.486	78.7 51.8	1.411	0.5				
	18 0		29.686	45.0	43.6	1.4			1.1	0.0			2.0
	20 0		686	49.9	47.8	2.1			0.1	0.0	WSW.	NNW ?	1.3
	22 0		675	56.1	52.7	3.4	64.7		0.1	0.3	SW by W.	WSW.	4.0
Aug. 21	0 0		656	60.6	55.8	4.8	41.0	0.000	0.3	0.1	WSW.	WSW.	8.8
	2 0		630	61.4	55.0	6.4			1.1	0.4	SW by S.	WSW.	9.8
	4 0		590	58.9	52.5	6.4			1.2	0.9	SW by S.	SW.	9.5
	6 0		526	57.1	52.0	5.1			1.0	0.5	SSW.	SSW : SW by S ?	9.0
	8 0		478	55.0	51.0	4.0			0.8	0.5	SSW.	SW by S.	10.0
	10 0		432	55.2	51.4	3.8			1.2	0.3	SSW.		10.0
	18 0		29.176	53.4	51.3	2.1			2.0	1.1	S.	S by W : SW.	9.7
	20 0		155	55.0	53.0	2.0			1.1	0.5	S.	S by W.	10.0
	22 0		107	56.6	54.9	1.7	63.4		1.2	0.5	S by E.	S by W.	10.0
Aug. 22	0 0		071	58.0	56.6	1.4	51.7	0.128	0.8	0.5	S.	S by W.	10.0
	2 0		075	58.3	56.6	1.7			1.9	0.1	SSW.	S by W.	10.0
	4 0		065	59.3	56.3	3.0			0.4	0.1	SW.	SW by W : S by W.	10.0
	6 0		069	58.5	54.6	3.9			0.7	1.3	SW.	WSW : S by W.	9.0
	8 0		098	54.2	52.2	2.0			0.3	0.0		SW.	8.5
	10 0		112	50.6	49.4	1.2			0.1	0.0			5.0
	18 0		29.164	44.8	44.0	0.8			0.0	0.0		SW.	0.5
	20 0		188	52.5	50.2	2.3			0.8	0.3	SW.	SW.	0.8
	22 0		224	56.0	51.7	4.3	61.6		1.9	0.8	SW by S.	SW : SSW.	3.5
Aug. 23	0 0		238	57.4	53.0	4.4	40.3	0.058	1.9	1.5	SW by S.	SW.	3.5
	2 0		265	61.2	53.7	7.5			1.7	1.2	SW by S.	SW.	3.0
	4 0		288	61.4	53.7	7.7			1.2	0.7	SW by S.	SW.	2.0
	6 0		311	58.5	52.1	6.4			1.5	0.3	SW.	SW.	0.5
	8 0		350	52.7	50.1	2.6			0.4	0.0			0.5
	10 0		381	47.7	47.0	0.7			0.0	0.0			0.3
	18 0		29.454	39.2	38.1	1.1			0.0	0.0		S.	1.5
	20 0		476	45.2	44.3	0.9			0.0	0.0	SW ?	SW ?	0.8
	22 0		498	54.4	52.7	1.7	62.4		0.0	0.0			1.0
Aug. 24	0 0		504	62.0	57.3	4.7	36.5	0.000	0.0	0.0		SW by S.	3.0
	2 0		513	67.6	59.0	8.6			0.1	0.0		S.	7.0
	4 0		520	67.7	57.9	9.8			0.2	0.1	SW.	S.	5.0

SPECIES OF CLOUDS, &c.	Observer's Initial.
h.	
0. Misty cumuli round horizon, broken cirrous masses; very hazy to E.	B
2. Loose cumuli; very hazy round horizon.	B
4. Id.; milky haze near the horizon.	W
6. Cirrous scud; very hazy near horizon.	W
8. Cirro-cumulous scud; thick haze.	W
10. Homogeneous.	B
18. Thick fog, apparently no clouds above; heavy dew.	W
20. Id., id.; the sun's disc faintly visible.	W
22. Hazy on horizon.	B
0. One or two patches of scud + large masses of cumuli to W.; patches of light cirri to S. [halo.	W
2. Woolly cirri in zenith + cumuli with cirrous crowns to NW.; patches of cumuli; upper portion of a solar	B
4. Cirrous-edged cumuli + hazy on horizon.	W
6. Patches of clouds; cumuli to SE.; haze on horizon.	W
8. A mass of pinnacle-cumuli to S.; cirro-strati to E.; cirrous haze and linear cirri round horizon.	B
10. Cirro-strati to NW.	B
23. A tremendous thunder-storm occurred during the night. The thunder was first heard about 12½ ^h , the storm attained its height about 14 ^h when sometimes three bright flashes were seen in the course of as many seconds, the thunder occasionally rattling in half a second after the lightning: thunder was heard till about 17 ^h but distant. This storm was felt all over Scotland, many accidents occurred. 1'411 inch of rain has fallen since midnight.	
18. Linear cirri, becoming cirrous haze to E.; cirro-strati to SW.	B
20. A patch of cirrus + cirro-strati and cirrous haze.	B
22. Scud and loose cumuli.	W
0. Id.	W
2. Id.	W
4. Dark scud and cumuli + linear cirri to E. [ance.	W
6. Scud: woolly cirro-cumuli + rows of cirro-cumuli and cirro-strati; the sky has a very disturbed appear-	B
8. Cirro-cumulous scud + cirro-cumuli in bluish cirrous haze.	W
10. Scud.	W
18. Thin smoky scud: cirro-cumulous scud, breaking in some places into the finest cirro-cumuli + fine woolly cirro-cumuli and cirri; clouds of all tints from white to blue in frequent alternation.	B
20. Scud + a homogeneous mass; rain.	B
22. Id. + id. id.	W
0. Id. id. id.	W
2. Id. id. id.	W
4. Id.: cirro-cumulous scud; cirrous haze.	W
6. Dark, heavy scud to N.: cirro-cumuli and patches of cirri + cumuli on S. horizon; raining to N.	W
8. Id., black cumuli and a dark mass of cirrous-edged cloud + cirro-stratus and haze on E. horizon; raining to SE. [and here lately.	W
10. Scud.	W
18. A range of scud to S. + cirrous-edged cirro-strati to E.; masses of cirri to S.	B
20. Id. id. id.	B
22. Masses of loose and ragged cumuli: sheets of mottled cirri, cirro-cumuli, and cirro-strati.	W
0. Cumuli and cirrous-edged scud + cirro-strati on E. horizon; a shower lately.	W
2. Masses of cumuli.	W
4. Id. + patches of cirri to W.	W
6. Id. + cirrous haze to S.	B
8. Scud and cumuli on N. horizon; cirro-strati and haze on SE. horizon.	W
10. Clouds on W. horizon.	W
18. Thick fog + fine cirro-cumuli, linear cirri and cirrous haze to E., the sun's image well defined in it; heavy [dew.	B
20. Smoky scud + large cirro-cumuli to W.; cirrous haze to E.	B
22. A bank of cirrous haze to E.; patches of cumuli near the horizon.	W
0. Loose detached cumuli + cirrous haze on E. horizon.	W
2. Loose cumuli and scud + cirro-strati to S.; black to SE.; cirrous haze to E.	W
4. Loose-edged cumuli and cirrous scud.	W

Göttingen Mean Time of Observation.			BARO- METER Corrected.	THERMOMETERS.				RAIN GAUGE.	ANEMOMETER.			Clouds moving from	Quan- tity of Clouds.
				Dry.	Wet.	Diff.	Max. and Min.		Pressure.		Direction of Wind.		
									Max.	Pres.			
Aug. 24	d. h. m.	in.	°	°	°	°	in.	lbs.	lbs.			0-10.	
	6 0	29.533	65.2	58.7	6.5			0.4	0.2	S by E.	S.	6-5	
	8 0	556	56.2	53.2	3.0			0.2	0.2	SSE.	S : WSW.	6.0	
	10 0	565	52.7	51.8	0.9			0.1	0.0			6.0	
	18 0	29.526	48.9	48.0	0.9			0.0	0.0		SSW.	8.5	
	20 0	526	53.3	52.1	1.2			0.0	0.0		SSW.	3.0	
	22 0	521	60.9	55.0	5.9	69.9		0.9	0.9	S.	S : SSW.	2.0	
Aug. 25	0 0	501	64.6	57.3	7.3	47.1	0.000	1.9	1.2	S by W.	S by W.	5.0	
	2 0	478	66.3	57.4	8.9			1.9	0.9	S.	S by W : S by W : SSW.	4.0	
	4 0	484	63.2	56.8	6.4			1.8	0.4	S by W.	S by W.	9.5	
	6 0	497	60.6	57.0	3.6			0.6	0.0		S by W.	9.9	
	8 0	524	59.0	56.4	2.6			0.0	0.0		SSW : S by W.	6.0	
	10 0	545	56.6	54.9	1.7			0.2	0.0	SW by S.		3.5	
	18 0	29.608	50.2	49.8	0.4			0.0	0.0		SSW ? : SSW.	5.0	
	20 0	622	53.2	51.8	1.4	66.8		0.0	0.0			1.0	
	22 0	616	61.2	57.9	3.3	45.5		0.6	0.3	SSW.	SW.	5.0	
Aug. 26	0 0	615	64.0	58.0	6.0		0.000	0.6	0.1	SW.	SW.	9.0	
	2 0	605	65.2	59.0	6.2			0.4	0.1	SW.	SW.	8.0	
	4 0	617	53.4	53.3	0.1			0.4	0.0	SW.	SW.	10.0	
	6 0	626	53.7	53.4	0.3			0.3	0.4	WSW.	SW.	9.8	
	8 0	650	50.9	50.3	0.6			0.4	0.0			2.5	
	10 0	697	51.0	50.3	0.7			0.2	0.2	SW.		0.3	
Aug. 27	0 0	66.6	0.330	0.8					
	18 0	29.705	46.8	46.5	0.3	42.8		1.4	0.0		WSW.	7.0	
	20 0	662	52.0	50.8	1.2			0.0	0.0		WSW.	10.0	
	22 0	617	60.0	56.3	3.7	64.1		0.6	0.6	S by E.	SSW.	9.7	
Aug. 28	0 0	549	62.3	57.8	4.5	44.3	0.000	1.1	0.9	S by E.	S.	9.9	
	2 0	485	61.2	57.9	3.3			2.9	1.4	S by E.	S.	9.9	
	4 0	416	63.0	59.6	3.4			2.5	1.0	S.	SSW.	10.0	
	6 0	379	62.9	60.0	2.9			1.7	1.4	S.	SSW.	10.0	
	8 0	372	60.7	60.0	0.7			1.4	0.4	S.	S ?	10.0	
	10 0	384	60.2	60.0	0.2			0.6	0.2	SW.		10.0	
	18 0	29.561	50.7	49.4	1.3			1.3	0.2	WNW.		2.5	
	20 0	617	52.0	49.4	2.6	65.0		0.4	0.1	WSW.		0.5	
	22 0	668	55.9	51.1	4.8	49.1		0.4	0.1	WNW.	NW and NNW.	1.3	
Aug. 29	0 0	702	58.1	51.5	6.6		0.105	0.5	0.3	NW by W.	W by N and NW.	3.0	
	2 0	732	62.7	54.3	8.4			0.9	0.5	W.	W.	4.5	
	4 0	753	63.1	54.8	8.3			0.8	0.1	W by N.	WNW.	4.0	
	6 0	775	61.0	53.3	7.7			0.5	0.3	W.	WNW.	1.5	
	8 0	802	55.3	50.3	5.0			0.3	0.2	WSW.		0.5	
	10 0	848	48.8	46.9	1.9			0.0	0.0			0.0	
	18 0	29.916	40.0	39.7	0.3			0.0	0.0			0.3	
	20 0	931	46.4	45.3	1.1	63.7		0.0	0.0		WNW.	0.3	
	22 0	942	55.3	51.7	3.6	37.2		0.0	0.0		WNW.	2.0	
Aug. 30	0 0	938	60.0	54.4	5.6		0.000	0.2	0.0	W.	W.	9.0	
	2 0	938	64.2	56.7	7.5			0.2	0.0	SW ?	W by S.	8.8	
	4 0	935	62.9	54.0	8.9			0.1	0.0	NNW.	W.	6.0	
	6 0	943	61.2	54.5	6.7			0.0	0.0		W.	7.0	
	8 0	941	54.6	52.0	2.6			0.0	0.0		SSW.	8.0	
	10 0	963	51.0	50.0	1.0			0.0	0.0			6.0	
	18 0	29.935	49.5	48.5	1.0			0.0	0.0		WSW.	10.0	

SPECIES OF CLOUDS, &c.	Observer's Initial.
h.	
6. Cirrous scud and cumuli + linear cirri to S.; hazy to E.	W
8. Scud and cumuli: thin cirrous haze and light cirri over most of the sky.	W
10. Sky almost covered with thin cirrous haze and linear cirri; patch of scud to W.	W
18. Cirro-cumuluous scud and woolly cirri + thick mass of cirro-strati to E. and SE.; mist; heavy dew.	B
20. Loose cirro cumuli, mottled and feathered cirri, cirro-cumuli to E. having the appearance of a bridge + cirro-strati to E.; range of cumulo-	B
22. Masses of loose cumuli: sheets of cirro-cumuli + cirro-strati to E. [strati to N.	W
0. Loose cumuli + patches of cirro-strati.	W
2. Detached cumuli: cirro-cumuluous scud: thin mottled cirri.	W
4. Scud + thick mass of cirrous clouds; cirro-strati and cumuli to E.; a few drops of rain.	B
6. Id. + id.; id.	B
8. Loose scud near horizon: cirro-cumuluous scud.	W
10. Scud.	W
18. Cirrous scud to W.: feathered and woolly cirri to S. + thick mass of linear cirri and cirrous haze to E.	B
20. Cirri; haze to E.	D
22. Scud and loose cumuli.	W
0. Id. + cirrous clouds.	W
2. Id.; dark scud to SW.	H
4. Scud + thick cirrous haze. Thunder and heavy showers at 3 ^b .	W
6. Id. + cumuli on S. horizon; heavy shower.	W
8. Scud and cirrous clouds near horizon.	W
10. Scud.	W
18. Woolly cirri and large woolly cirro-cumuli + cirro-strati round horizon.	W
20. Thick nearly homogeneous cirrous mass + cirro-strati to E.; a few drops of rain.	W
22. Thick mass of cirro-cumuluous clouds, scud and cumuli to S.; clouds breaking, sky to N. and S.; cirro-strati and cirrous haze to E. and S.	B
0. Scud + dense cirrous mass.	B
2. Id. + id.	B
4. Id. + id.; black to N.	W
6. Loose scud + cirrous clouds; a few drops of rain.	W
8. Thin scud, nearly homogeneous; light rain.	B
10. Id., id.; light rain; the wind blew 0.8 lb. in a few minutes after this.	B
18. Scud and cirro-cumuli to SE.; cirro-strati on E. horizon; fine linear cirri to W.	W
20. Cirro-strati to E. and to W. lying NE. to SW.	W
22. Loose cumuli and scud + cirrous haze to E.	B
0. Id. + id. [from W.	B
2. Loose cumuli in detached masses which have an internal motion from NW. and W., the whole moving	B
4. Loose cumuli.	W
6. Id.	W
8. Cirrous haze to E.; patches of loose cumuli to E.	B
10. Very clear, not a speck of cloud to be seen.	B
18. Cirro-strati to N.; heavy dew.	W
20. Linear cirri to E.; patches of clouds to E.	W
22. Loose cumuli + linear cirri and cirrous haze to E.	B
0. Loose cirro-cumuluous cumuli.	B
2. Id.	B
4. Id.	W
6. Id.; cirrous haze to W.	W
8. Loose gray cirro-cumuli, scattered over the sky, which is quite milky.	B
10. Id. id.	B
18. Cirro-cumuluous scud + cirrous clouds and cirro-cumuli.	W

Göttingen Mean Time of Observation.			BARO- METER Corrected.	THERMOMETERS.				RAIN GAUGE.	ANEMOMETER.			Clouds moving from	Quan- tity of Clouds.
				Dry.	Wet.	Diff.	Max. and Min.		Pressure.		Direction of Wind.		
									Max.	Pres.			
Aug. 30	d. 20 h. 0 m. 0		in. 29.965	° 53.0	° 51.1	° 1.9	° 67.9	in. 0.0	lbs. 0.0	lbs. 0.0	W by N.		0-10.
	22 0		972	56.7	53.0	3.7	48.0		0.0	0.0	W by N.	W by N.	7.0
Aug. 31	0 0		972	63.3	56.0	7.3		0.000	0.0	0.2	SW by S.	W.	8.5
	2 0		958	67.1	59.1	8.0			0.0	0.2	SW by S.	W?	9.8
	4 0		950	67.0	59.8	7.2			0.2	0.0	WSW.		10.0
	6 0		953	62.7	58.4	4.3			0.2	0.0	SW by S.	SW by W.	10.0
	8 0		949	59.3	56.8	2.5			0.0	0.0	SW by S.		10.0
	10 0		961	58.1	56.2	1.9			0.0	0.0	NW by W?		8.5
	18 0		29.999	55.3	54.4	0.9			0.2	0.0		W.	4.0
	20 0		30.027	58.3	57.6	0.7	71.3		0.2	0.0	SW by W.	W by N.	9.0
	22 0		30.059	65.4	62.6	2.8	53.3		0.1	0.0	WSW.	W by N.	9.8
Sept. 1	0 0		30.063	66.7	62.6	4.1		0.000	0.1	0.0		W.	10.0
	2 0		30.091	66.3	62.6	3.7			0.2	0.0		W.	10.0
	4 0		30.090	68.1	64.0	4.1			0.1	0.0		W.	10.0
	6 0		30.091	66.8	63.7	3.1			0.1	0.0		W.	10.0
	8 0		30.097	60.7	59.0	1.7			0.1	0.0		SSW.	10.0
	10 0		30.114	59.0	58.0	1.0			0.0	0.0			10.0
	18 0		30.073	60.0	58.2	1.8			0.2	0.1	WSW.	WSW.	10.0
	20 0		081	62.3	60.4	1.9	70.9		0.3	0.0		WSW.	10.0
	22 0		085	67.4	64.1	3.3	56.5		0.4	0.5	SW by W.	W by N : W.	9.0
Sept. 2	0 0		086	71.0	66.9	4.1		0.000	0.5	0.0		W.	9.0
	2 0		077	70.6	67.8	2.8			0.3	0.1	SW by W.	W.	10.0
	4 0		075	69.9	65.0	4.9			0.4	0.3	W by N.	W.	10.0
	6 0		070	68.1	63.1	5.0			0.5	0.0	W by N.	W.	8.0
	8 0		067	63.5	62.2	1.3			0.1	0.0	W by S?	W.	3.5
	10 0		065	61.9	60.4	1.5			0.2	0.1	SW by W.	W.	2.0
Sept. 3	0 0		29.800	73.3	0.000	1.9				
	18 0		29.987	51.0	47.4	3.6	58.1		3.6	0.6	W by S.	WNW.	4.5
	20 0		30.017	53.9	52.9	1.0	70.5		0.6	0.4	WSW.	WNW.	6.5
	22 0		30.058	58.0	52.9	5.1	49.5		0.7	0.5	NW.	NW by W : NW by W.	6.5
Sept. 4	0 0		30.075	60.2	52.3	7.9		0.000	1.0	0.4	NW.	NW by N.	3.3
	2 0		30.092	62.2	53.1	9.1			1.0	0.5	NNW.	NNW.	1.5
	4 0		30.097	63.0	53.3	9.7			1.0	1.1	NNW.	NW by N.	1.5
	6 0		30.112	61.2	52.9	8.3			0.6	0.1		NW by N.	1.3
	8 0		30.145	55.5	51.0	4.5			0.4	0.1			0.3
	10 0		30.171	50.6	47.9	2.7			0.3	0.0	SW.		0.1
	18 0		30.199	39.7	38.6	1.1			0.2	0.0			0.3
	20 0		200	46.8	44.8	2.0	63.4		0.0	0.0			0.1
	22 0		189	53.4	49.9	3.5	36.8		0.0	0.0			0.1
Sept. 5	0 0		162	60.0	54.8	5.2		0.000	0.1	0.1	SW.		0.2
	2 0		139	65.9	59.1	6.8			0.1	0.0		NNW.	1.0
	4 0		111	68.2	58.9	9.3			0.4	0.2	NW by N.	NNW.	2.0
	6 0		101	65.2	58.3	6.9			0.4	0.2	NW by W.	NW.	6.0
	8 0		107	59.6	56.2	3.4			0.3	0.0			6.0
	10 0		088	57.1	55.6	1.5			0.0	0.0			8.0
	18 0		30.065	54.0	52.7	1.3			0.1	0.0	W?	NW by W.	9.0
	20 0		065	59.0	57.2	1.8	68.6		0.1	0.0		NW by W.	7.0
	22 0		058	66.8	62.7	4.1	49.7		0.1	0.1	W by S.	NW : NW.	3.0
Sept. 6	0 0		048	72.2	66.0	6.2		0.010	0.1	0.0		WNW.	8.0
	2 0		038	71.2	65.0	6.2			0.7	0.0	W by S.	W by N.	8.0
	4 0		025	72.2	66.0	6.2			0.1	0.0	W by S.	W.	3.0

SPECIES OF CLOUDS, &c.

Observer's
Initial.

- h.
20. Cirrous haze and linear cirri.
22. Fine cirro-cumuli, becoming very small at the edges, lying in lines from NW. ; linear cirri lying in different directions, chiefly from NW. ; woolly and flame cirri, all moving slowly ; cirrous haze to E.
0. A few patches of woolly cirri or cirrous scud ? + sky nearly covered with fine linear cirri and cirrous haze ; solar halo.
2. Thick large woolly cirro-cumuli + cirrous haze to E.
4. Thick cirrous haze and cirro-cumuli ; cirro-strati round horizon.
6. Thin scud, moving slowly + thick cirro-cumuli and cirrous haze ; slight rain lately.
8. Thick cirrous clouds, black cirro-cumuli below ; a little ago, sky seen with beautifully mottled and feathered cirri and cirro-cumuli.
10. Cirrous clouds ? ; sky in zenith.
18. Cirro-cumulo-strati + linear and mottled cirri to E. ; cirro-strati on E. horizon ; loose scud lying on
20. Id. + cirro-strati to E. [Cheviot.
22. Id. + id.
0. Scud + thick cirrous haze and cirro-cumuli ; cirro-strati on horizon.
2. Id. + cirrous clouds.
4. Id. + id. ; loose cumuli on N. horizon.
6. Cirro-cumulo-strati + loose scud near horizon.
8. Scud + cirro-cumuli and cirrous haze ; dark to E. ; light rain.
10. Scud and cirrous clouds.
18. Scud + thick mass of cirrous clouds.
20. Id. + id.
22. Cirrous scud : woolly cirro-cumuli ; cirrous haze.
0. Scud + cirro-cumuli and cirrous clouds.
2. Id. + id.
4. Id. + id.
6. Id. + id.
8. Cirro-cumulo-strati and cirro-strati ; cirrous haze to E.
10. Scud + cirrous haze.
18. Beautiful strata of mottled, reticulated, and woolly cirri, the lines lying at right angles to the direction of the strata ; patches of scud to SW.
20. Sheets of thin, woolly, fretted, and cirro-cumulous cirro-strati, lying from WNW. ; streaks of fine mottled cirri ; cirrous haze ; loose cumuli on Cheviot.
22. Loose cumuli, agitated by different currents : large woolly cirro-cumuli to N. and E. + cirro-strati to N. [and E.
0. Loose cumuli + cirro-strati to N. and E.
2. Id. + id.
4. Scud and loose cumuli + cirrous haze to NE.
6. Id. + id.
8. Cirro-strati to NE.
10. Streaks of cirro-stratus to NE.
18. A sheet of cirro-stratus to E. ; heavy dew.
20. A strip of cirro-stratus to NE.
22. Id.
0. Id.
2. Sheets of cirro-cumuli and mottled cirri, cirro-strati + cirro-strati and cirrous haze on NE. and N. horizon.
4. Id., id. + id. id.
6. Id., id. + id. id.
8. Id., id.
10. Thin scud, cirro-cumuli and cirro-strati ; light shower ; a lunar rainbow for a few minutes, quite complete.
18. Cirro-cumulo-strati + patches of woolly cirri above cirro-strati to E.
20. Id. + id.
22. Masses of loose cumuli and scud to W. : sheets of cirro-cumuli and mottled cirri + cirro-strati on horizon.
0. Scud and loose cumuli + cirro-cumuli ; cumulo-strati on E. horizon ; dark to SW.
2. Cirro-cumulo-strati + cumulo-strati to SE. ; cirro-strati.
4. Woolly cirro-cumuli, moving slowly + cumuli on S. horizon.

W

B

B

W

W

B

B

W

W

W

B

B

W

W

W

B

B

W

W

W

B

B

B

W

W

B

B

W

W

W

B

Göttingen Mean Time of Observation.			BARO- METER Corrected.	THERMOMETERS.				RAIN GAUGE.	ANEMOMETER.			Clouds moving from	Quan- tity of Clouds.	
				Dry.	Wet.	Diff.	Max. and Min.		Pressure.		Direction of Wind.			
									Max.	Pres.				
Sept. 6	d. 6	h. 0	m. 0	in. 30.018	° 68.7	° 64.4	° 4.3	°	in. 0.2	lbs. 0.1	lbs. 0.1	WSW.	W by N.	0-10.
		8	0	026	62.5	60.7	1.8		0.0	0.0	0.0		W by N.	3.0
		10	0	028	60.7	59.0	1.7		0.0	0.0	0.0			7.0
		18	0	30.040	44.1	43.0	1.1		0.0	0.0	0.0		WSW : W ?	8.0
		20	0	056	52.3	51.0	1.3	73.6	0.0	0.0	0.0			4.0
		22	0	054	60.3	54.8	5.5	41.5	0.1	0.1	0.1	WSW.		0.5
Sept. 7	0	0	0	052	65.6	56.4	9.2		0.4	0.4	0.4	SW.		0.3
	2	0	0	039	69.0	59.0	10.0	0.000	0.4	0.3	0.3	SW by S.		0.1
	4	0	0	033	71.3	61.8	9.5		0.6	0.0	0.0	SW by W.		0.2
	6	0	0	027	68.0	61.0	7.0		0.3	0.0	0.0			0.4
	8	0	0	038	59.0	57.2	1.8		0.1	0.0	0.0			0.1
	10	0	0	048	54.2	53.3	0.9		0.0	0.0	0.0			0.0
	18	0	0	30.051	42.0	41.2	0.8		0.0	0.0	0.0			0.2
	20	0	0	055	49.3	47.8	1.5	71.0	0.0	0.0	0.0			0.1
	22	0	0	057	59.9	56.6	3.3	40.5	0.0	0.0	0.0			0.1
Sept. 8	0	0	0	051	71.5	63.2	8.3		0.1	0.1	0.1	SW.		0.2
	2	0	0	027	75.6	65.8	9.8	0.000	0.2	0.0	0.0	SW.		0.3
	4	0	0	009	76.3	65.0	11.3		0.0	0.0	0.0		WSW.	1.0
	6	0	0	000	73.6	67.8	5.8		0.0	0.0	0.0			0.5
	8	0	0	007	62.8	60.0	2.8		0.0	0.0	0.0			1.5
	10	0	0	017	56.6	54.9	1.7		0.0	0.0	0.0			3.0
	18	0	0	29.993	49.3	48.9	0.4		0.0	0.0	0.0			1.5
	20	0	0	30.006	52.0	52.0	0.0	77.0	0.0	0.0	0.0			2.0
	22	0	0	30.009	60.0	58.9	1.1	47.4	0.0	0.0	0.0			0.5
Sept. 9	0	0	0	29.985	69.3	64.0	5.3		0.0	0.0	0.0			0.2
	2	0	0	29.945	75.6	64.3	11.3	0.000	0.2	0.1	0.1	SE.		0.3
	4	0	0	29.923	76.0	63.8	12.2		0.6	0.2	0.2	SSE.		1.0
	6	0	0	29.915	70.9	60.8	10.1		0.3	0.1	0.1	SSE.		0.5
	8	0	0	29.922	62.3	58.4	3.9		0.3	0.0	0.0			0.3
	10	0	0	29.920	54.7	54.3	0.4		0.0	0.0	0.0			0.1
Sept. 10	0	0	0	76.7	0.000	0.2	0.2			9.0
	18	0	0	29.675	57.9	57.4	0.5	46.4		0.3	0.0		SE.	10.0
	20	0	0	29.729	59.7	59.3	0.4	71.0		0.0	0.0		SE by S.	6.5
	22	0	0	29.763	62.0	61.2	0.8	54.8		0.2	0.1	NE by N.	NE : SSE.	8.0
Sept. 11	0	10	10	29.798	65.2	62.6	2.6		0.2	0.1	0.1	NE.	E : SE : SSE.	10.0
	2	0	0	29.832	68.3	64.6	3.7	0.202	0.2	0.1	0.1	WSW and NNW : SE by E.		10.0
	4	0	0	29.869	63.1	61.6	1.5		0.6	0.2	0.2	NE by N.		10.0
	6	0	0	29.904	61.8	60.5	1.3		0.3	0.1	0.1	NNE.	ENE.	8.0
	8	0	0	29.948	59.6	59.0	0.6		0.0	0.0	0.0			10.0
	10	0	0	30.002	57.2	57.1	0.1		0.0	0.0	0.0			10.0
	18	0	0	30.087	58.0	57.7	0.3		0.0	0.0	0.0			10.0
	20	0	0	124	57.9	57.6	0.3	70.4		0.0	0.0		E ?	10.0
	22	0	0	136	60.0	59.3	0.7	56.5		0.0	0.0			10.0
Sept. 12	0	0	0	144	63.3	61.9	1.4		0.0	0.0	0.0			10.0
	2	0	0	133	67.7	64.3	3.4	0.008	0.2	0.1	0.1	ENE.	SSE and SE.	7.0
	4	0	0	117	64.6	61.9	2.7		0.5	0.3	0.3	ENE.		1.0
	6	0	0	110	64.7	61.2	3.5		...	0.2	0.2	ENE.		1.0
	8	0	0	131	59.3	58.7	0.6		0.2	0.1	0.1	ENE.	S.	9.5
	10	0	0	131	56.2	55.6	0.6		0.1	0.1 ?	0.1	ENE.		8.0
	18	0	0	30.086	47.0	46.6	0.4		0.0	0.0	0.0			3.0
	20	0	0	083	50.7	50.1	0.6	72.2		0.0	0.0			10.0
	22	0	0	069	55.2	54.7	0.5	44.9		0.0	0.0		SSE.	1.0

Sept. 9^d 4^h. When the dry and wet thermometers were carried to the E. end of the Observatory the readings were 75°-8 and 62°-2.

SPECIES OF CLOUDS, &c.

Observer's
Initial.

h.		
6.	Woolly cirro-cumuli, moving slowly + cirro-strati to E., sheets of cirro-cumuli.	B
8.	Id. + cirro-cumulo-strati to W., cirro-strati.	W
10.	Cirro-cumuli; a dark mass of cirro-cumulous scud to W.	W
18.	Fog on the ground: sheets of fretted woolly cirri.	B
20.	Diffuse cirri.	B
22.	Light cirri to N.	W
0.	Id. NE.	W
2.	Small patches of cirrus, thin cirrous haze on E. horizon.	W
4.	Diffuse cirri to NE.	B
6.	Id.	B
8.	Small patches of cirrus, cirrous haze to E.	W
10.	Beautifully clear.	W
18.	Patches of mottled and diffuse cirri, cirrous haze to E., fog, heavy dew.	B
20.	Id., id. id. id.	B
22.	Streaks of cirro-stratus to NE.	W
0.	A few patches of cirro-cumuli.	W
2.	Bundles of flame-like and curl cirri to N. and NW., cirrous haze on N. horizon.	W
4.	Curled, mottled, and flame-like cirri; hazy on horizon.	B
6.	Pathes of cirrus, thick cirrous haze on S. and E. horizon.	W
8.	Id.	B
10.	Thin cirrous haze covering a great part of the sky.	W
18.	Patches of cirri; thick fog and very heavy dew.	B
20.	Id.; id. id.	B
22.	Id.; cirrous haze on N. and E. horizon.	W
0.	Id.; id.	W
2.	Id.; id.	W
4.	Thin cirri forming; id.	W
6.	Diffuse cirri; brown haze to E.	B
8.	Cirri and cirro-strati to N. and NW.	W
10.	Streaks of cirri and cirrous haze to N.	W
18.	Cirro-cumulous scud + loose scud; rain during the night.	W
20.	Scud + loose misty scud, very low, creeping along N. horizon.	W
22.	Thin smoky scud, very low, moving quickly, sometimes covering the whole sky: masses of woolly cirrous cloud or loose cumuli, moving slowly +	B
0.	Thin scud: scud: woolly scud + fine cirri.	B
2.	Smoky scud in two currents, lately: woolly scud + cumuli to S.	B
4.	Homogeneous misty scud.	W
6.	Thin misty scud + loose cumuli to SW.; general haze.	W
8.	Thick misty scud.	W
10.	Id.	B
18.	Fog.	W
20.	Id.	W
22.	Homogeneous scud; fog.	B
0.	Id.; fog, distant.	B
2.	Woolly loose cumuli; hazy.	B
4.	Loose cumuli on S. and E. horizon; hazy on horizon.	W
6.	Loose cumuli and scud on E. and S. horizon; hazy on horizon; streaks of cirri to NE.	W
8.	Loose, ragged, detached, smoky scud.	B
10.	Id.	B
18.	Clouds near the horizon, thin fog, heavy dew.	W
20.	Thick fog.	W
22.	Loose cumuli, patches moving across the zenith evaporate; clouds of mist rising from the ground to E.	B

Göttingen Mean Time of Observation.			BARO- METER Corrected.	THERMOMETERS.				RAIN GAUGE.	ANEMOMETER.			Clouds moving from	Quantity of Clouds.
				Dry.	Wet.	Diff.	Max. and Min.		Pressure.		Direction of Wind.		
									Max.	Pres.			
Sept. 13	d. h. m.	in.	°	°	°	°	in.	lbs.	lbs.			0-10.	
	0 0	30.036	62.1	58.4	3.7		0.000	0.1	0.1 ?	SSE.	SE ?	0.3	
	2 0	29.995	65.9	59.0	6.9			...	0.3	SE by E.		0.3	
	4 0	29.958	64.0	56.8	7.2			...	0.2	SE by S.		0.2	
	6 0	29.936	59.6	55.6	4.0			0.5	0.2	SE.		0.2	
	8 0	29.931	52.6	50.9	1.7			...	0.0			0.2	
	10 0	29.910	47.8	46.8	1.0			...	0.0			0.1	
	18 0	29.807	43.9	43.7	0.2			...	0.0		SE.	8.0	
	20 0	798	50.0	49.6	0.4	65.9		...	0.0			10.0	
	22 0	798	55.7	55.0	0.7	37.5		...	0.1	SE ?	NE.	1.5	
Sept. 14	0 0	783	62.4	57.8	4.6		0.000	...	0.0	ENE ?	Various.	1.3	
	2 0	757	65.6	59.1	6.5			0.4	0.3	ENE.	SSE : SSW.	4.0	
	4 0	755	64.8	58.2	6.6			0.3	0.2	NE by E.	S.	7.0	
	6 0	753	61.0	57.2	3.8			...	0.1	NE.	S.	9.0	
	8 0	763	57.0	55.7	1.3			...	0.1	NE ?		10.0	
	10 0	761	56.2	55.3	0.9			0.0	0.0			10.0	
	18 0	29.753	55.9	55.3	0.6			...	0.2	NE.		10.0	
	20 0	776	57.0	56.4	0.6	65.8		...	0.0			10.0	
	22 0	773	59.9	58.5	1.4	53.5		0.4	0.3	NE.	NE.	10.0	
Sept. 15	0 0	756	64.4	61.0	3.4		0.000	0.4	0.4	NE.	ESE ?	0.3	
	2 0	733	67.9	63.2	4.7			0.6	0.5	NE by E.		0.2	
	4 0	711	67.2	59.1	8.1			0.5	0.5	NE.		0.3	
	6 0	717	63.0	58.0	5.0			0.4	...			2.0	
	8 0	730	56.7	54.8	1.9			0.3	0.0	ESE ?		0.2	
	10 20	745	51.8	51.2	0.6			0.2	0.0			0.2	
	18 0	29.763	46.0	45.9	0.1			0.0	0.0			4.0	
	20 0	783	49.6	49.3	0.3	68.8		0.0	0.0		S.	9.0	
	22 0	782	58.2	57.0	1.2	45.3		0.1	0.0			1.3	
Sept. 16	0 0	782	69.9	64.4	5.5		0.000	1.8	1.7	S by E.	S : S by E.	7.5	
	2 0	767	71.9	63.4	8.5			1.3	1.2	S by W.	S : S.	5.0	
	4 0	753	70.6	63.2	7.4			2.1	1.2	S.	S by W.	2.5	
	6 0	774	67.0	62.2	4.8			1.3	0.0		S by W.	3.0	
	8 0	797	59.2	58.8	0.4			0.0	0.0		S by W : S.	3.0	
	10 0	831	55.6	54.9	0.7			0.0	0.0			0.8	
Sept. 17	0 0	74.2		0.7		SSW.			
	8 +	48.6							
	18 0	29.758	53.8	53.7	0.1			0.7	0.0	SW by S.	SW : SSW.	9.0	
	20 0	751	60.3	59.1	1.2	69.1		0.9	0.7	SW by S.	SW.	7.0	
	22 0	762	63.3	59.0	4.3	47.1		2.1	1.8	SW.	SW by S.	7.0	
Sept. 18	0 0	755	67.7	63.5	4.2		0.084	2.3	1.4	SW.	SW.	9.5	
	2 0	773	66.1	62.6	3.5			2.7	1.3	SSW.	SW.	10.0	
	4 0	827	59.2	56.7	2.5			1.1	0.1	W.	SW.	10.0	
	6 0	858	59.6	56.1	3.5			0.1	0.1	W ?	SW.	9.5	
	8 0	918	54.3	52.2	2.1			0.2	0.0			7.5	
	10 0	951	50.3	49.1	1.2			0.1	0.0			2.5	
	18 0	30.069	39.3	38.7	0.6			0.1	0.0			2.0	
	20 0	093	43.4	43.0	0.4	67.6		0.0	0.0		SW.	4.0	
	22 0	103	51.0	49.7	1.3	36.4		0.0	0.0		SW.	4.0	
Sept. 19	0 0	095	59.7	55.1	4.6		0.040	0.0	0.0		SW.	8.0	
	2 0	066	64.0	58.0	6.0			0.0	0.0		SW.	8.0	
	4 0	037	66.2	59.9	6.3			0.2	0.1	ESE ?	SW.	9.5	
	6 0	027	59.3	56.1	3.2			0.0	0.0		SW.	9.5	

September 13^d 7^h—14^d 23^h. The suspending cord of the Anemometer weight having broken, the observations during this period were estimated.

SPECIES OF CLOUDS, &c.	Observer's Initial.
h.	
0. Patches of loose cumuli ; hazy to E.	B
2. Id. ; id.	B
4. Cumulo-stratus on E. horizon.	W
6. Scud and loose cumuli low on E. horizon.	W
8. Id.	B
10. Id.	B
18. Scud.	W
20. Thick fog.	W
22. Thin scud, much of it having a rotatory motion + loose-edged cumuli on horizon ; mist rising from the [ground to E.	B
0. Loose cumuli moving from all directions between ESE. and SSW., breaking into ragged patches which vanish before reaching the Prime Vertical ; mottled cirri and cirrous haze to S. and E.	B
2. Cirrous scud : varieties of cirri + cirro-strati to S.	B
4. Cirro-cumuli, woolly cirri and cirrous haze + patches of cumuli to N.	W
6. Cirro-cumuli and thick cirrous haze + patches of scud on E. horizon.	W
8. Id. + id. ; red to NW.	B
10. Homogeneous ; a few drops of rain.	B
18. Homogeneous.	W
20. Id.	W
22. Id. ; foggy cloud.	B
0. Patches of loose cumuli + cirrous haze to W.	B
2. Patches of scud to N. and of cirro-strati to S.	B
4. Sheets of cirro-cumuli, mottled cirri and cirro-strati to S. ; patch of scud to N.	W
6. Large cirro-cumuli + masses of scud on E. horizon ; woolly and mottled cirri to N.	W
8. Patches of cirro-strati and cirro-cumuli.	B
10. Id.	B
18. Foggy.	W
20. Id. ; linear and woolly cirri.	B
22. Cirro-strati and linear cirri to N.	W
0. Loose cumuli : cirro-cumuli and mottled cirri ; cirro-strati on horizon.	W
2. Loose cumuli : cirro-cumuli + cirro-strati on E. and S. horizon.	W
4. Id. + haze on E. horizon.	W
6. Id. + id.	W
8. Id. : cirro-cumuli.	W
10.	W
8 + 17 ^d 8 ^h 20 ^m —9 ^h . Much lightning was observed due south, frequent and bright flashes, but often faint ; no clouds nor thunder.	B
18. Thin scud : thick scud ; clouds breaking ; thick to E. ; sky milky.	B
20. Scud + patches of cirro-strati.	B
22. Id., moving rapidly + patches of linear cirri ; cirro-strati on S. and NE. horizon.	W
0. Scud + linear cirri.	W
2. Id. + id.	W
4. Thick scud ; occasional showers.	B
6. Woolly cirri + patches of scud and dark cirro-strati.	B
8. Patches of scud ; cirrous clouds.	W
10. A faint aurora beyond clouds to N. ; slight pulsations.	W
18. Red cirro-strati to E. ; rather thick fog ; heavy dew.	B
20. Feathered, diffuse, and crystallized-like cirri, moving slowly.	B
22. Woolly and curled cirri, moving slowly + large cirro-cumuli to S. ; cirro-strati near horizon.	W
0. Cirro-cumulo-strati + linear cirri and cirro-strati.	W
2. Cirro-cumuli, woolly cirri, and cirrous haze.	W
4. Loose woolly cirro-cumuli.	W
6. Id. + woolly cirri.	B

SPECIES OF CLOUDS, &c.

Observer's
Initial.

8. Cirrous scud, woolly cirro-cumuli.	W
10. Scud ; a lightish appearance to NNW., like aurora.	W
18. Scud and loose cumuli, moving slowly + cirro-strati ; sky hazy ; light mist.	B
20. Patches of scud : feathered cirri.	B
22. Id. : woolly cirro-cumuli ; haze on E. horizon.	W
0. Loose cumuli and scud + patches of linear and woolly cirri.	W
2. Id. id.	W
4. Scud.	W
6. Id. + cirrous clouds to N. ; cumuli on N. horizon.	W
8. Masses of scud near horizon.	W
10. Cirro-strati to N.	D
18. Scud + cirro-strati on E. horizon.	D
20. Id. + id.	W
22. Id. + feathered and woolly cirri.	W
0. Cirrous-edged and loose cumuli + varieties of cirri.	B
2. Masses of scud + cirri and cirro-strati to E.	W
4. Loose cumuli + cirro-strati to S.	D
6. Cirro-strati on S. horizon ; cirrous haze on E. horizon.	B
8. Clear.	B
10. Id.	H
18. A streak of cirro-stratus to NE. ; light mist.	B
20. Cirrous scud to N. and NE.	B
22. Clear.	W
0. Id.	W
2. Id.	W
4. A few patches of hazy cirro-stratus to NNW.	B
6. Id.	W
8. Id.	W
10. Clear.	W
18. Cirro-strati on NE. horizon ; stratus in the valleys ; heavy dew.	B
20. Mottled cirri and cirro-strati to N. and E.	B
22. Streaks of cirro-strati to E.	W
0. Hazy cirro-strati to E.	W
2. Woolly and linear cirri + hazy cirro-stratus on E. horizon.	W
4. Patches of cirri ; haze to E.	W
6. Id. to N.	W
8. Clear.	W
10. Id.	W
18. Scud ; slight drizzle.	W
20. Id. ; id.	W
22. Id. + cirro strati and cirrous clouds.	W
0. Masses of scud to S. : woolly cirri + cirro-strati to NE.	W
2. Scud : cirro-cumuli and woolly cirri.	W
4. Scud and loose cumuli + cirrous clouds.	W
6. Id. + id.	W
8. Scud and cirrous clouds.	W
10.	W
18. Scud + linear cirri and cirro-strati to NE.	W
20. Woolly cirri and large cirro-cumuli + heavy dense masses of cirro-strati all round the horizon.	W
22. Scud.	W

Göttingen Mean Time of Observation.			BARO- METER Corrected.	THERMOMETERS.				RAIN GAUGE.	ANEMOMETER.			Clouds moving from	Quan- tity of Clouds.
				Dry.	Wet.	Diff.	Max. and Min.		Pressure.		Direction of Wind.		
									Max.	Pres.			
Sept. 26	d. h. m.	in.	°	°	°	°	in.	lbs.	lbs.			0-10.	
	0 0	29.949	49.0	43.0	6.0		0.000	0.7	0.6	NNW.	NNW : N by E.	8.0	
	2 0	914	52.7	45.4	7.3			1.1	0.4	N.	N.	9.0	
	4 0	862	51.4	44.4	7.0			1.0	0.3	N by W.	N by W.	9.5	
	6 0	809	49.7	43.0	6.7			0.3	0.1	NNW.	N.	10.0	
	8 0	760	48.3	43.8	4.5			0.1	0.0			10.0	
	10 0	730	46.7	45.2	1.5			0.1	0.0			10.0	
	18 0	29.627	40.5	38.0	2.5			0.7	0.0		N : NW.	9.5	
	20 0	606	43.9	40.9	3.0			0.6	0.2	NNW.	N by W.	6.5	
	22 0	599	46.7	41.0	5.7	52.3		1.5	1.2	N by W.	N.	3.0	
Sept. 27	0 0	585	49.3	43.9	5.4	38.4	0.005	1.6	0.4	N.	N by E.	9.0	
	2 0	571	49.3	43.7	5.6			1.6	1.0	N by W.	N by E : N by E.	7.0	
	4 0	568	48.6	44.0	4.6			1.4	0.6	N by W.	N by E.	4.0	
	6 0	574	43.0	41.3	1.7			2.1	0.2	N by W.	N by E.	3.0	
	8 0	582	43.2	40.9	2.3			0.9	0.1	N by W.	N by E.	3.5	
	10 0	586	45.0	41.4	3.6			0.6	0.9	N by W.		8.5	
	18 0	29.600	40.6	38.5	2.1			1.0	0.2	NW by W.	N by E.	6.5	
	20 0	616	41.6	39.0	2.6			0.3	0.2	NW by N.	N by E.	4.0	
	22 0	623	46.6	41.7	4.9	50.2		1.3	0.7	NW by N.		2.5	
Sept. 28	0 0	623	48.1	42.2	5.9	37.7	0.012	2.4	2.2	N by W.	N.	4.0	
	2 0	634	50.2	44.2	6.0			2.2	1.6	N by W.	N.	7.5	
	4 0	629	51.1	44.9	6.2			1.8	0.8	N.	N : N.	9.8	
	6 0	656	47.1	43.7	3.4			1.6	0.1	N.	N by W : N.	8.0	
	8 0	685	44.3	42.0	2.3			0.2	0.0			8.0	
	10 0	705	42.4	40.8	1.6			0.0	0.0			4.0	
	18 0	29.741	35.0	34.4	0.6			0.1	0.0		NW.	6.5	
	20 0	749	35.6	34.7	0.9			0.0	0.0		NNW.	5.0	
	22 0	746	45.0	42.9	2.1	51.8		0.0	0.0		NNW.	9.0	
Sept. 29	0 0	735	49.0	44.4	4.6	30.6	0.005	0.2	0.1	NW ?	W : NNW.	5.5	
	2 0	694	53.1	47.8	5.3			0.3	0.5	SW by W.	W : NNW.	9.5	
	4 0	683	51.8	47.7	4.1			0.5	0.1	W by S.	W by N.	10.0	
	6 0	635	50.9	47.9	3.0			0.3	0.1	W.	W.	10.0	
	8 0	614	49.9	47.2	2.7			0.6	0.2	SW by W.		10.0	
	10 0	555	48.1	47.9	0.2			0.7	0.3	SW.		10.0	
	18 0	29.385	53.9	52.7	1.2			1.5	0.0		WNW.	10.0	
	20 0	428	56.0	54.3	1.7			0.1	0.0		NW by W : NW.	9.8	
	22 0	468	60.0	56.8	3.2	54.2		0.3	0.4	W by S.	WNW : WNW.	5.0	
Sept. 30	0 0	490	64.0	58.9	5.1	46.5	0.252	0.9	0.5	WSW.	NW by W.	7.5	
	2 0	512	62.2	57.2	5.0			1.1	1.1	W.	WNW : NW by N.	7.0	
	4 0	542	62.0	57.1	4.9			1.6	0.3	W.	WNW : NW.	8.0	
	6 0	568	57.0	55.3	1.7			0.5	0.1	WNW.	WNW.	10.0	
	8 0	563	55.1	54.9	0.2			0.2	0.1	SW.		10.0	
	10 0	552	55.7	55.5	0.2			0.3	0.2	SW.		10.0	
Oct. 1	1 0 0	64.5	0.404	1.3	0.7	SW.			
	18 0	29.626	51.1	47.9	3.2			2.4	0.5	WSW.	WNW : W by N.	4.5	
	20 0	658	51.1	48.0	3.1			1.0	0.5	W.	W by N.	3.0	
	22 0	671	54.3	49.0	5.3	65.4		1.6	1.6	W.	W by N : W.	2.0	
Oct. 2	0 0	685	55.6	50.3	5.3	48.4	0.008	2.1	1.6	WNW.	W : WNW.	6.5	
	2 0	695	57.6	50.9	6.7			2.4	1.3	W by N. v.	W by N : WNW.	8.0	
	4 0	711	56.9	50.2	6.7			1.8	1.2	W by N.	W by N.	3.0	
	6 0	731	52.1	47.6	4.5			2.0	0.8	W by S.		2.0	
	8 0	777	49.3	46.5	2.8			0.7	0.1	WSW.	WNW : WNW.	7.0	
	10 0	796	46.5	44.4	2.1			0.3	0.1	WSW.	WNW.	6.0	

SPECIES OF CLOUDS, &c.	Observer's Initial.
0. Two currents of scud.	W
2. Scud + cirro-cumuli and cirrous clouds.	W
4. Id. + cirro-cumuli; cirro-strati on horizon.	W
6. Id. + cirrous clouds.	W
8. Id. + id.	W
10. Id.; slight drizzle at 9 ^h .	W
18. Scud: thin cirro-cumuli to S.	W
20. Id.	W
22. Large cirro-cumuli + masses of scud near the horizon; cirro-strati on S. horizon.	W
0. Scud and loose cumuli.	W
2. Id.: cirri.	W
4. Scud and cirrous-edged loose cumuli + loose nimbus to E.; occasional slight showers.	W
6. Id. + loose cumulo-strati on E. and NE. horizon; nimbi to S. and SE.; passing showers.	W
8. Scud; passing showers.	W
10. Id.	W
18. Id.	W
20. Id.	W
22. Scud and cirro-strati near horizon.	W
0. Scud + cirro-strati to S. and W.	W
2. Scud and loose cumuli + cirro-cumuli.	W
4. Masses of scud: large cirro-cumuli.	W
6. Id. id.	W
8. Scud and cirro-cumuli.	W
10. Scud.	W
18. Scud + linear cirri to NW. lying ENE. to WSW.; hoar-frost.	W
20. Varieties of cirri + cumulo-strati on E., and cirro-strati on S. horizon.	W
22. Woolly and diffuse cirri with cirrous haze.	W
0. Masses of scud: woolly and curled cirri.	W
2. Id.: large cirro-cumuli.	W
4. Scud.	W
6. Id. + cirrous clouds and haze.	W
8. Id.; a few drops of rain.	W
10. Heavy rain.	W
18. Scud.	W
20. Id.: woolly, linear, and mottled cirri.	W
22. Id.: id.; cirro-strati on horizon.	W
0. Scud and loose cumuli + cirro-cumulo-strati to SW.	W
2. Id.: cirro-cumuli + linear cirri to E.; thick mass of cirro-strati to W.	W
4. Id.: id. + dense cirro-strati all round the horizon; woolly cirri.	W
6. Dense homogeneous mass of cirro-stratus; light rain.	W
8. Light rain.	W
10. Raining rather heavily.	W
18. Masses of scud to NW.: cirro-cumuli, woolly cirri and cirrous haze moving off.	W
20. Masses of scud.	W
22. Patches of loose scud: sheets of woolly cirri and cirro-cumuli + cirro-strati to E. and S.	W
0. Loose scud: cirrous-edged, very loose cumuli + cirro-strati to S.	W
2. Scud and loose cumuli: mottled and linear cirri.	W
4. Scud and loose cirrous-edged cumuli.	W
6. Masses of cirrous scud; loose cumuli on N. and S. horizon; patches of cirri.	W
8. Scud: mottled cirri, causing an indistinct coloured lunar corona about 4° radius.	W
10. Scud + cirro-strati to S.	W

Göttingen Mean Time of Observation.			BARO- METER Corrected.	THERMOMETERS.				RAIN GAUGE.	ANEMOMETER.		Clouds moving from	Quan- tity of Clouds.	
				Dry.	Wet.	Diff.	Max. and Min.		Pressure.				Direction of Wind.
									Max.	Pres.			
Oct.	d. h. m.		in.	°	°	°	°	in.	lbs.	lbs.		0-10.	
	2 18 0		29.797	47.6	45.5	2.1			0.5	0.1	WSW.	W by N.	9.0
	20 0		797	49.1	47.6	1.5	59.4		0.1	0.1	SW by W.	SSW : W.	10.0
	22 0		792	51.7	50.7	1.0	38.6		0.5	0.4	SW.	Sward : W.	10.0
Oct.	3 0 0		787	58.0	54.1	3.9		0.008	0.7	0.3	SW.	W.	9.8
	2 0		773	57.2	52.8	4.4			0.6	0.1	WSW.	W by N.	10.0
	4 0		766	57.9	52.7	5.2			0.6	0.2	SW by W.	W : NW by W.	9.8
	6 0		761	55.0	50.9	4.1			0.3	0.0		WNW.	9.8
	8 0		763	53.4	51.1	2.3			0.2	0.0	SW.		9.5
	10 0		767	51.9	50.1	1.8			0.1	0.0		WNW.	9.5
	18 0		29.780	50.3	50.0	0.3			0.1	0.0			10.0
	20 0		775	50.9	50.7	0.2	58.4		0.0	0.0			10.0
	22 0		773	59.9	57.2	2.7	48.4		0.4	0.7	W by N.	WNW.	9.8
Oct.	4 0 0		768	62.0	56.7	5.3		0.030	1.2	0.7	W.	W.	9.3
	2 0		761	63.5	56.9	6.6			1.1	1.7	W by N.	W.	7.5
	4 0		748	63.0	57.8	5.2			1.6	0.9	SW.	W : W.	9.0
	6 0		754	60.0	55.8	4.2			1.9	1.1	SW by W.	W.	9.5
	8 0		770	58.1	55.0	3.1			1.0	0.1	SW.	W.	9.8
	10 0		763	57.9	55.0	2.9			0.3	0.2	SW by S.	W.	8.8
	18 0		29.735	55.3	51.8	3.5			0.8	0.2	SW.	W.	10.0
	20 0		740	55.0	53.0	2.0			0.2	0.0		W.	10.0
	22 0		736	57.0	53.7	3.3	64.4		0.2	0.2	SW by S.	W by S.	10.0
Oct.	5 0 0		723	60.0	55.8	4.2	52.3	0.004	0.5	0.3	SW.	WSW.	10.0
	2 0		694	63.3	58.1	5.2			0.7	0.4	SSW.	WSW.	9.8
	4 0		664	61.0	55.6	5.4			0.6	0.2	SW.	WSW.	9.8
	6 0		640	58.1	54.8	3.3			0.6	0.2	SW.	SW.	5.0
	8 0		625	55.1	53.4	1.7			0.1	0.0		SW.	9.8
	10 0		578	55.6	53.6	2.0			0.1	0.1	SW.	SW ?	10.0
	18 0		29.316	58.0	54.9	3.1			0.9	1.4	S by W.	SW by S.	10.0
	20 0		276	55.9	54.0	1.9	65.0		1.9	1.1	S by W.	SW by S.	10.0
	22 0		237	58.1	56.8	1.3	54.5		1.0	0.3	SSW.	SW by S.	10.0
Oct.	6 0 0		196	60.0	57.9	2.1		0.029	2.2	1.7	SSW.	SSW : SW by S.	9.5
	2 0		170	61.7	58.1	3.6			2.7	1.6	SW by S.	SW by S.	10.0
	4 0		135	60.5	57.5	3.0			1.8	0.6	SW by S.	SW by S : SW by W.	9.8
	6 0		093	58.0	55.7	2.3			1.4	0.8	SW by S.	SSW.	10.0
	8 0		064	54.7	52.9	1.8			0.9	0.4	SW by S.	SSW : SW.	7.0
	10 0		034	53.9	53.1	0.8			1.5	0.3	SSW.	SW by S.	9.5
	18 0		29.031	52.7	51.7	1.0			0.8	0.2	SW by W.	W.	8.5
	20 0		070	54.6	53.0	1.6	63.0		1.0	0.2	SW.	W.	3.0
	22 19		081	57.9	54.3	3.6	49.4		1.0	0.5	SW.	W by S.	5.0
Oct.	7 0 0		096	58.4	53.7	4.7		0.182	1.6	0.6	SW.	W by S : W by S.	4.0
	2 0		099	61.6	53.1	8.5			2.6	1.8	SW.	W : W.	7.0
	4 0		081	58.0	51.6	6.4			2.8	2.0	SW by W.	W by S : W.	2.5
	6 0		062	53.9	49.6	4.3			2.4	1.1	SW.	W by S : W.	4.0
	8 0		049	52.5	49.9	2.6			1.1	0.2	SW.		10.0
	10 0		018	50.7	50.0	0.7			0.2	0.1	SW.		10.0
Oct.	8 0 0		62.4 46.0	0.253	2.3				
	18 0		30.228	39.3	38.8	0.5			3.8	0.0		W.	9.0
	20 0		229	43.0	42.7	0.3	51.8		0.0	0.0		WNW.	9.5
	22 0		241	48.1	46.3	1.8	35.4		0.0	0.0		NNW ?	9.9
Oct.	9 0 0		260	50.2	47.7	2.5		0.012	0.2	0.1	NNW.	NW by N.	10.0
	2 0		296	47.7	46.6	1.1			0.3	0.2	NE by N.	NNE.	10.0
	4 0		343	46.9	44.5	2.4			0.5	0.1	NE.	N by W.	10.0

SPECIES OF CLOUDS, &c.

Observer's
Initial.

h.		
18.	Scud + cirro-strati on E. horizon, tinged with red.	W
20.	A line of loose scud to SE. : scud + cirro-strati to E.	W
22.	Smoky scud on E. horizon : scud.	W
0.	Scud, thick to N. + cirro-cumuli and cirro-strati to S.	W
2.	Id. + cirrous clouds and cirro-strati.	W
4.	Id. : woolly cirri, cirro-cumuli, cirro-strati, and cirrous haze.	W
6.	Cirro-cumulo-strati ; cirrous haze.	W
8.	Dense mass of cirrous clouds and haze.	W
10.	Large cirro-cumuli + cirro-strati on horizon.	W
18.	Scotch mist.	W
20.	Id.	W
22.	Two kinds of scud, one very thin.	W
0.	Scud + cirro-strati to N.	B
2.	Id. + cirrous haze to N.	B
4.	Id. : woolly cirri + cirrous haze and cirro-strati to N. [cirro-cumuli.	B
6.	Id. + cirri-like rolled masses of curls, and somewhat bentlike cymoid cirri, other varieties of cirri ;	B
8.	Scud.	B
10.	Id., moving rather quickly.	B
18.	Id.	W
20.	Id.	W
22.	Id.	B
0.	Id.	W
2.	Id.	W
4.	Id.	W
6.	Id. and cirro-cumulo-strati.	W
8.	Id.	B
10.	Id.	B
18.	Scud + cirro-strati on E. horizon tinged with red.	W
20.	Id. + thick mass of cirrous clouds and haze ; a shower since 18 ^h .	W
22.	Id. + id. ; light rain.	B
0.	Two currents of scud ; light rain.	B
2.	Scud + cirrous clouds and haze ; light rain.	W
4.	Id. : id.	W
6.	Id. + id.	W
8.	Id. : cirro-cumuli.	W
10.	Id., moving quickly + cirro-cumuli ; occasional showers ; heavy shower immediately.	W
18.	Id.	W
20.	Id. + cirro-strati to S.	W
22.	Id. + patches of cirro-strati.	W
0.	Id. : mottled and linear cirri + patches of cirro-strati ; raining to E.	W
2.	Scud and loose cumuli : mottled, woolly, and linear cirri.	W
4.	Id., in patches : woolly and curled cirri.	W
6.	A mass of scud : woolly and diffuse cirri and loose cirro-cumuli + cirro-strati.	W
8.	Thick mass of diffuse cirri and cirrous haze ; masses of scud and cirro-cumuli.	W
10.	Scud ; thick cirrous mass ; light rain.	W
18.	Scud + woolly and diffuse cirri.	B
20.	Woolly cirrous scud.	B
22.	Id. + cirrous clouds, cirro-strati and haze.	W
0.	Scud + cumuli ; cirro-strati to S.	W
2.	Id.	W
4.	Cirrous scud + scud, lower.	B

Göttingen Mean Time of Observation.			BARO- METER Corrected.	THERMOMETERS.				RAIN GAUGE.	ANEMOMETER.			Clouds moving from	Quan- tity of Clouds.
				Dry.	Wet.	Diff.	Max. and Min.		Pressure.		Direction of Wind.		
									Max.	Pres.			
Oct.	d.	h.	m.	in.	°	°	°	°	in.	lbs.	lbs.		
	9	6	0	29.420	45.8	43.9	1.9	°		0.2	0.0		0-10.
		8	0	482	44.0	43.0	1.0			0.1	0.0	N by W.	10.0
		10	0	543	43.9	42.9	1.0			0.0	0.0		10.0
		18	0	29.634	42.3	41.9	0.4			0.0	0.0		10.0
		20	0	632	42.2	41.9	0.3	53.4		0.0	0.0	NNW : NE ?	10.0
		22	0	619	44.9	44.6	0.3	40.5		0.0	0.0	ENE : W by S.	10.0
Oct.	10	0	0	595	44.0	43.4	0.6		0.039	0.0	0.0	S.	10.0
		2	0	559	47.6	45.7	1.9			0.0	0.0	W.	9.0
		4	0	511	45.7	44.7	1.0			0.1	0.0	W.	9.8
		6	0	481	42.1	41.5	0.6			0.0	0.0	W.	10.0
		8	0	443	39.1	38.8	0.3			0.0	0.0		10.0
		10	0	395	38.7	38.4	0.3			0.0	0.0		10.0
		18	0	29.122	40.0	39.9	0.1			0.0	0.0		10.0
		20	0	29.066	41.0	40.8	0.2	49.1		0.0	0.0	ESE.	10.0
		22	0	29.009	42.6	42.3	0.3	36.5		0.0	0.0	ESE.	10.0
Oct.	11	0	0	28.958	45.2	44.3	0.9		0.420	0.0	0.0	ESE.	10.0
		2	0	28.879	43.6	43.3	0.3			0.0	0.0	ESE.	10.0
		4	0	28.826	43.4	43.1	0.3			0.0	0.0	ENE ? : ESE.	10.0
		6	0	28.771	42.0	41.6	0.4			0.1	0.1	NE.	10.0
		8	0	28.755	42.1	41.5	0.6			0.2	0.2	NE.	10.0
		10	0	28.760	42.1	41.1	1.0			0.4	0.8	NNE.	10.0
		18	0	28.867	42.0	39.7	2.3			7.5	4.4	N by E.	10.0
		20	0	28.949	40.7	40.1	0.6	44.5		5.3	1.8	N by E.	9.8
		22	0	29.048	42.0	39.3	2.7	38.5		5.0	2.4	N by W.	9.5
Oct.	12	0	0	29.126	41.8	39.0	2.8		0.890	4.3	2.1	N by W.	9.0
		2	0	29.155	43.6	38.0	5.6			3.8	1.9	NW by N.	2.5
		4	0	29.138	45.0	38.4	6.6			2.2	1.0	WNW.	3.0
		6	0	29.140	42.0	38.3	3.7			2.1	0.9	W.	2.5
		8	0	29.210	34.6	33.3	1.3			2.8	0.0	NW by N ?	3.0
		10	0	29.232	33.5	30.2	3.3			1.2	0.5	NNW.	0.1
		18	0	29.309	31.3	29.9	1.4			2.4	0.2	W.	0.3
		20	0	311	32.3	30.2	2.1	45.0		0.3	0.2	SW by W.	0.2
		22	0	293	38.4	34.0	4.4	28.3		0.5	0.4	W by S.	0.2
Oct.	13	0	0	271	42.3	37.1	5.2		0.012	4.1	1.4	W.	0.8
		2	0	275	43.9	38.9	5.0			3.0	0.9	W.	9.5
		4	0	249	37.9	36.9	1.0			1.1	0.1	NW by W.	6.0
		6	0	273	37.9	35.9	2.0			0.4	0.0	NW ?	6.5
		8	0	288	35.9	33.1	2.8			0.5	0.3	NW by W.	2.0
		10	0	338	35.9	33.6	2.3			1.5	0.2	NW by W.	3.0
		18	0	29.502	34.0	32.6	1.4			0.8	0.2	NW by W.	0.3
		20	0	538	36.4	34.0	2.4	45.3		0.2	0.6	NW.	0.3
		22	0	562	41.0	37.4	3.6	32.5		0.4	0.2	NW by W.	0.3
Oct.	14	0	0	582	44.6	39.3	5.3		0.077	0.8	0.2	NNW.	0.5
		2	0	587	45.7	40.1	5.6			0.5	0.2	NNW.	5.0
		4	0	588	44.6	39.0	5.6			0.3	0.0	NW.	4.0
		6	0	587	36.0	34.8	1.2			0.0	0.0	NW ?	5.0
		8	0	584	29.9	29.6	0.3			0.0	0.0		0.3
		10	0	580	28.4			0.1	0.0		1.0
Oct.	15	0	0	46.3		0.4			
		18	0	29.451	26.4	25.7	0.7	25.5		1.2	0.0	NW.	1.5
		20	0	452	26.0			0.1	0.0	NW.	3.0
		22	0	431	32.6	30.2	2.4	44.1		0.1	0.1	WSW ?	3.0
								21.7					

SPECIES OF CLOUDS, &c.

Observer's
Initial.

h.		
6.	Scud +- cirrous clouds.	B
8.	Id. +- id.	W
10.	Id. ; a slight shower lately.	W
18.	Scud and cirrous clouds.	B
20.	Thin smoky scud : smoky scud on S. horizon +- woolly cirri ; slight shower lately.	B
22.	Thin scud : thin cirrous scud and haze, moving slowly ; slight shower lately.	W
0.	Scud ; a few drops of rain.	W
2.	Loose cumuli and scud : cirrous scud.	W
4.	Black, ragged, loose, electric-looking cumuli along N. and S. horizon + thick mass of woolly and linear cirri and cirrous haze ; solar halo 22° [radius.	B
6.	Sky covered with woolly cirri, patches of cirro-cumuli, thick cirrous haze +- masses of loose scud on horizon.	W
8.	Thick cirrous mass ; heavy dew.	W
10.	Quite homogeneous.	W
18.	Homogeneous ; light rain.	B
20.	Scud +- homogeneous clouds above ; light rain.	B
22.	Id. +- id. ; id.	W
0.	Id. ; raining.	W
2.	Id. ; id.	W
4.	Two currents of scud ; heavy rain.	W
6.	Scud ; breaking up a little to SE. ; rain ceased at 5 ^h 15 ^m .	W
8.	Homogeneous.	W
10.	Scud.	W
18.	Homogeneous smoky scud, the Moon seen through it ; light rain.	B
20.	Scud +- woolly cirri.	B
22.	Loose scud : cirro-cumulo-strati +- cirro-strati to N.	W
0.	Two strata of scud +- patches of cirri.	W
2.	Patches of woolly cirri +- loose cumuli near horizon.	W
4.	Masses of cirro-strati +- scud and cumuli on N. and NE. horizon.	W
6.	Scud and loose cumuli all round the horizon.	W
8.	Scud ; a shower of hail about 7 ^h .	W
10.	Small patches of clouds on horizon.	W
18.	A strip of cloud on E. horizon ; sky very clear ; ground covered with hoar-frost.	B
20.	Cumuli on E. horizon.	B
22.	Cumulo-strati and cirro-strati on NE. horizon ; faint streaks of cirrus to SE.	W
0.	Cumulo-strati on E. and NE. horizon ; masses of scud moving along N. horizon ; cirro-strati to S.	W
2.	Scud and loose cumuli.	W
4.	Id. +- cumuli on E. and N. horizon ; heavy shower of hail 15 ^m since, passed off to S.	W
6.	Patches of scud +- piles of gray cumuli to SE. ; blue haze and cirro-strati to E.	W
8.	Scud.	W
10.	Loose scud.	W
18.	Cirro-strati on horizon.	B
20.	Cirro-strati, moving slowly +- cumuli on E. horizon.	B
22.	Patches of cumuli and cirro-strati on E. and N. horizon.	W
0.	Patches of scud and loose cumuli +- cirro-strati to N. and S.	W
2.	Masses of loose cumuli : woolly, mottled, and linear cirri and cirro-strati.	W
4.	Cirri as before +- cirro-strati and cirrous haze on horizon ; masses of cumuli.	W
6.	Scud to S. +- diffuse cirri over the sky ; cumuli to E.	B
8.	Clouds to N.	W
10.	Cirrous clouds, much hoar-frost.	W
10.	An Auroral arch about 15° altitude, with bright streamers at the extremities and fainter ones within the [arch.	
18.	Light cirri +- cumulo-strati to E. ; cirro-strati to E. and NE.	W
20.	Mottled, woolly, and linear cirri, cirro-strati +- cirro-cumulo-strati to N. ; cumulo-strati on E. horizon.	W
22.	Id. +- id. id.	B

Göttingen Mean Time of Observation.			BARO- METER Corrected.	THERMOMETERS.				RAIN GAUGE.	ANEMOMETER.			Clouds moving from	Quantity of Clouds.
				Dry.	Wet.	Diff.	Max. and Min.		Pressure.		Direction of Wind.		
									Max.	Pres.			
Oct. 16	d. h. m.		in.	°	°	°	°	in.	lbs.	lbs.			1-10.
	0 0		29.402	40.0	34.5	5.5			0.2	0.2	WSW ?	NW.	2.0
	2 0		370	41.3	35.7	5.6		0.017	0.2	0.0	WSW.	WNW.	5.0
	4 0		332	41.8	37.7	4.1			0.2	0.1	WSW.	W.	9.0
	6 0		304	35.1	34.3	0.8			0.2	0.1	WSW.	SSW.	10.0
	8 0		280	35.3	33.5	1.8			0.1	0.0	WSW.		9.8
	10 0		245	34.8	32.2	2.6			0.0	0.0			9.8
	18 0		29.208	36.4	34.7	1.7			0.4	0.1	NE.		10.0
	20 0		262	35.7	35.0	0.7			1.0	0.5	NNE.	NE by E.	10.0
	22 0		299	34.3	33.3	1.0	46.6		0.5	0.0		ENE.	10.0
Oct. 17	0 0		325	39.8	39.2	0.6	31.4	0.387	1.8	1.2	N by E.	ENE.	10.0
	2 0		371	35.8	35.5	0.3			3.1	1.4	NNE.	NNE.	10.0
	4 0		411	36.5	36.3	0.2			2.1	1.4	NNE.	NNE.	9.8
	6 0		465	37.2	37.0	0.2			1.8	0.3	N by E.		10.0
	8 0		515	37.2	35.0	2.2			1.7	1.6	N.		3.0
	10 0		571	35.1	32.8	2.3			1.7	0.6	NNW.	NNE ?	0.5
	18 0		29.688	28.8			0.9	0.0			0.5
	20 0		29.719	28.1	27.6	0.5	39.9		0.2	0.1	NW ?	N.	0.5
	22 0		29.768	36.2	32.2 ?	4.0 ?	27.2		0.1	0.1	NW ?		0.3
Oct. 18	0 0		29.808	39.7	35.7	4.0		0.333	0.4	0.2	N by W.	N.	1.3
	2 0		29.842	41.0	38.0	3.0			0.5	0.4	NNW.	N by E.	2.5
	4 0		29.878	43.0	39.4	3.6			0.2	0.1	N.	N by E.	6.0
	6 0		29.929	35.4	34.3	1.1			0.2	0.1	N.		1.0
	8 0		29.966	32.2	31.0	1.2			0.0	0.0			0.0
	10 0		30.014	30.3	29.6	0.7			0.0	0.0			0.0
	18 0		30.120	24.0	23.6 ?	0.4			0.0	0.0			0.3
	20 0		153	26.2	26.0 ?	0.2	43.3		0.0	0.0			8.0
	22 0		152	33.0	31.0	2.0	21.6		0.0	0.0		W.	7.0
Oct. 19	0 0		161	40.4	35.9	4.5		0.007	0.1	0.1	W by S.	WNW.	2.0
	2 0		124	44.4	39.3	5.1			0.3	0.2	W by S.		0.3
	4 0		110	44.7	39.8	4.9			0.4	0.4	WSW.		0.3
	6 0		107	39.6	37.2	2.4			0.3	0.1	SW.		0.5
	8 0		079	39.2	37.2	2.0			0.1	0.0			4.0
	10 0		061	37.2	36.0	1.2			0.0	0.0			1.0
	18 0		29.926	42.0	40.4	1.6			1.1	0.4	SW by W.		8.0
	20 0		890	45.3	43.4	1.9	45.1		0.6	0.5	SW.	W by S.	10.0
	22 0		880	47.2	45.2	2.0	35.5		1.1	0.2	SW by W.	W.	8.5
Oct. 20	0 0		858	49.4	47.1	2.3		0.000	0.8	0.2	SW by W.	W.	9.8
	2 0		815	50.5	47.5	3.0			0.9	1.0	SW.	W by S.	10.0
	4 0		753	50.9	47.9	3.0			1.5	0.3	SW by W.	WSW : WSW : W : NW ?	8.0
	6 0		703	48.1	45.6	2.5			0.7	0.1	SW.	SW.	10.0
	8 0		648	47.0	45.4	1.6			0.2	0.3	SW.	WSW.	3.0
	10 0		589	47.2	45.8	1.4			0.5	0.4	SW by S.		9.8
	18 0		29.428	47.0	46.8	0.2			1.6	0.0			10.0
	20 0		488	47.8	46.6	1.2	51.1		0.5	0.8	NW by N.	NW by N : W ?	9.8
	22 0		559	48.7	45.7	3.0	44.3		0.7	0.3	NW by W.	NW by N : W ?	9.5
Oct. 21	0 0		619	50.8	46.9	3.9		0.063	0.9	0.3	NW by W.	W by S.	7.0
	2 0		647	50.5	44.8	5.7			0.9	0.3	NW by W.	WNW.	7.0
	4 0		671	51.5	44.5	7.0			0.5	0.4	WNW.	WNW.	3.5
	6 0		684	44.1	41.1	3.0			0.3	0.0		WNW.	2.0
	8 0		711	41.2	39.2	2.0			0.1	0.0			1.0
	10 0		703	40.1	38.7	1.4			0.2	...	SW by W ?		4.0
Oct. 22	0 0		29.440	53.3 38.9	0.007	4.2	2.4	SW by W.		

SPECIES OF CLOUDS, &c.

Observer's
Initial.

- h.
0. Mottled, woolly, and linear cirri, cirro-strati + cirro-cumulo-strati to N. ; cumulo-strati on E. horizon.
2. Cirro-cumulo-strati and woolly cirro-cumuli + cumuli to E.
4. Scud.
6. Id. + cirrous haze.
8. Cirrous clouds ?
10. Id. ; Auroral light to NNW ?
18. Thick cirrous clouds ; scud below to N.
20. Scud + cirrous clouds and haze ; stormy-looking to SE. ; a few drops of rain.
22. Scud ; rain, hail, and sleet.
0. Id., id., id., id. ; Cheviot white.
2. Id. ; heavy shower of hail and sleet from 2^h 0^m till 2^h 15^m when it began to snow.
4. Id. ; heavy showers of snow and rain since last observation ; breaking to N.
6. Cirro-cumuli and cirrous haze, stationary ; scud and loose cumuli on horizon ; showers.
8. Scud ; a few drops of rain.
10. Scud to E.
18. Cumulo-strati on E. horizon ; cirro-strati to N.
20. Cirro-cumulo-strati + cumulo-strati on E. horizon.
22. Well-defined cumulo-strati to NE. ; cirrous-sided to E. and SE.
0. Cumulo-strati, with cirrous crowns, or changing into cirro-strati or sheets of cirri.
2. Loose and cirrous-edged cumuli + cumuli, crowned with cirri and apparently falling in snow.
4. Loose cumuli.
6. Id. on E. and N. horizon.
8. Clear.
10. Id.
18. Cirro-strati to E.
20. Cirro-strati on E. horizon ; cumuli in zenith.
22. Woolly cirri + patches of mottled cirri.
0. Woolly, mottled, and linear cirri and cirro-strati.
2. Cirro-strati to S.
4. Cirrous haze and cirro-strati on N. and E. horizon.
6. Id.
8. Id.
10. Id.
18. Scud ; cirro-strati, cirrous clouds and haze.
20. Id. + thick cirrous clouds and haze.
22. Smoky scud + sheets of faint woolly cirro-cumuli.
0. Cirro-cumulo-strati and large woolly cirro-cumuli ; cirro-strati on E. horizon.
2. Scud + cirrous clouds.
4. Thin smoky scud : woolly cirro-cumuli : woolly cirri : mottled cirri.
6. Scud + cirrous clouds.
8. Id. + cirro-strati to N.
10. Id. ; light shower since last observation.
18. Light rain.
20. Patches of thin smoky scud, low : thick dark mass of cirrous clouds and haze.
22. Id. : id. ; sky to N. and W.
0. Woolly cirro-cumuli and cirro-strati, moving slowly ; sky to W. and N.
2. Loose cumuli.
4. Loose woolly cirro-cumulous cumuli.
6. Scud to E. + cirro-cumuli and cirrous haze to W.
8. Haze near horizon ; sky hazy.
10. Cirro-strati scattered over the sky.

B
W
W
W
B
B
B
W
W
B
B
W
W
B
W
W
B
W
W
B
W
W
B
B
W
W
B
B
W
W
B
B
W
W
B
B
W
W
B
B

Göttingen Mean Time of Observation.			BARO- METER Corrected.	THERMOMETERS.				RAIN GAUGE.	ANEMOMETER.			Clouds moving from	Quantity of Clouds.
				Dry.	Wet.	Diff.	Max. and Min.		Pressure.		Direction of Wind.		
									Max.	Pres.			
Oct. 22	18	0	29.518	46.7	44.7	2.0		in.	lbs.	lbs.			0-10.
	20	0	574	49.8	46.6	3.2			3.2	0.3	SW by W.		0.1
	22	0	595	50.4	46.0	4.4	58.0		0.4	0.3	SW. v.	W by N : WNW.	7.0
Oct. 23	0	0	578	52.7	46.9	5.8	44.5		2.6	1.0	W. v.	W by N : W by N.	8.0
	2	0	565	51.6	46.6	5.0		0.008	2.2	1.6	W by N. v.	W by S : WNW.	9.5
	4	0	521	50.6	46.7	3.9			4.7	2.0	WSW. v.	WSW.	10.0
	6	0	460	50.1	47.2	2.9			2.8	2.2	SW.	W by S.	10.0
	8	0	397	51.3	48.7	2.6			3.2	1.3	SW.	W by S.	10.0
	10	0	395	51.0	47.2	3.8			4.1	1.9	SW.	W by S.	10.0
	18	0	29.312	44.0	41.7	2.3			4.3	1.4	SW.		3.5
	20	0	299	45.0	42.0	3.0	54.1		3.2	1.0	SW.		10.0
	22	0	289	46.9	43.4	3.5	43.1		1.8	1.0	SW.	W : W ?	8.0
Oct. 24	0	0	266	45.1	44.2	0.9			1.7	0.4	SW.	W.	6.0
	2	0	236	41.5	40.6	0.9		0.054	4.2	1.0	WSW.	W by S.	10.0
	4	0	173	42.9	41.3	1.6			2.1	0.3	WSW ?		10.0
	6	0	149	39.7	38.4	1.3			0.3	0.3	WSW.	WSW.	9.3
	8	0	146	38.2	37.0	1.2			0.4	0.2	SW.	W by N.	6.0
	10	0	149	33.3	32.1	1.2			0.4	0.3	SW.		0.1
	18	0	29.124	33.3	32.8	0.5			0.6	0.0	SW by W.		0.0
	20	0	137	31.7	31.2	0.5	48.7		0.5	0.6	SW by W.		0.0
	22	0	141	37.9	36.8	1.1	30.8		0.7	...	SW.	W ?	0.3
Oct. 25	0	0	137	45.1	42.0	3.1		0.005	0.1	0.1	SW.	W by N.	2.5
	2	0	119	45.0	41.0	4.0			0.4	0.4	SW by W.	W by S.	3.5
	4	0	122	45.7	40.7	5.0			0.7	0.3	WSW.	W.	2.0
	6	0	120	40.7	38.2	2.5			0.6	0.6	SW by W.	W : NW.	3.0
	8	0	122	37.3	35.6	1.7			0.5	0.4	SW by W.		5.0
	10	0	127	36.3	35.0	1.3			0.3	0.1	WSW.		0.3
	18	0	29.181	29.8			0.2	0.0	WSW.		0.3
	20	0	221	34.2	32.9	1.3	47.7		0.2	0.1	NW.	NW.	1.8
	22	0	241	40.2	37.1	3.1	28.1		0.5	0.4	NW.	NNW ?	0.3
Oct. 26	0	0	257	43.6	38.2	5.4		0.004	0.6	0.5	NW by W.	WNW.	1.5
	2	0	262	46.0	40.1	5.9			0.6	0.4	WNW.	WNW.	5.0
	4	0	283	41.8	37.9	3.9			0.4	0.0			1.0
	6	0	301	33.9	32.7	1.2			0.1	0.0			1.0
	8	0	329	28.3	27.9	0.4			0.0	0.0			0.5
	10	0	353	28.0	27.6	0.4			0.0	0.0			0.5
	18	0	29.363	25.7	25.3	0.4			0.0	0.0			0.0
	20	0	369	25.9	25.5 ?	0.4 ?	46.1		0.0	0.0			0.8
	22	0	367	32.0	30.7	1.3	23.3		0.0	0.0		WNW.	3.0
Oct. 27	0	0	331	42.8	40.8	2.0		0.005	0.4	0.2	SW by S.	SW : W by N.	8.0
	2	0	289	44.6	41.3	3.3			0.4	0.3	SW by S.	W ?	10.0
	4	0	252	43.2	40.8	2.4			0.5	0.1	S.	SSW ?	10.0
	6	0	216	41.0	37.1	3.9			0.8	0.5	S by E.		10.0
	8	0	179	36.7	35.0	1.7			0.6	0.0			7.0
	10	0	141	39.4	36.9	2.5			1.0	0.4	S by E.		5.0
	18	0	28.723	41.2	39.9	1.3			2.8	2.8	E. v.		10.0
	20	0	625	43.6	43.0	0.6	45.4		4.1	1.4	E by N. v.	E by S.	10.0
	22	0	522	45.9	45.2	0.7	35.7		2.7	2.0	E by N.	E by S.	10.0
Oct. 28	0	0	417	48.0	47.0	1.0		0.209	2.6	0.8	E.	ESE.	10.0
	2	0	423	45.1	43.0	2.1			1.5	0.8	E.	ESE.	9.9
	4	0	424	43.7	41.8	1.9			1.3	0.3	NE.	E by N : E.	9.0
	6	0	435	41.4	40.1	1.3			0.4	0.3	NNW.	N by E.	10.0
	8	0	485	40.0	39.3	0.7			0.7	0.7	NW by N.	N.	6.5
	10	0	558	41.7	40.7	1.0			1.6	0.8	WNW.		9.5

SPECIES OF CLOUDS, &c.

Observer's
Initial.

h.		
18.	Cirro-strati to E.	B
20.	Thin scud, moving quickly : diffuse, woolly, and mottled cirri and cirro-cumuli.	B
22.	Scud : woolly cirro-cumuli, woolly cirri and cirro-strati.	W
0.	Id. : woolly cirri.	W
2.	Cirrous scud + cirrous clouds and haze.	W
4.	Scud + cirri.	B
6.	Id.	W
8.	Id.	W
10.	Id.	W
18.	Homogeneous ; a few drops of rain ; wind in gusts.	B
20.	Thin smoky scud : strata of woolly and woven cirri and cirro-cumuli + cirro-strati to E.	B
22.	Loose scud + cirro-cumuli and cirrous clouds to S.	W
0.	Scud ; a slight shower lately.	W
2.	Light rain.	W
4.	Scud + cirrous clouds ; a few drops of rain ; occasional showers.	B
6.	Id. + cirro-cumulous scud to S.	W
8.		W
10.		W
18.	Streaks of cirro-strati to N. and SW. ; hoar-frost.	B
20.	Patches of cirri + cirro-strati to SE. and N.	B
22.	Woolly cirri + id. S. ; scud to W.	W
0.	Scud and loose cumuli + patches of cirri and cirro-strati.	W
2.	Loose cumuli + patches of cirri and cirro-strati.	W
4.	Id. : woolly cirri, moving very slowly + cumuli on S. horizon.	B
6.	Woolly cirri ; patches of scud.	B
8.	Masses of scud. Much lightning without thunder seen about 8 ^h 20 ^m by Mr Rule, the land-steward.	W
10.	Patches of cloud.	W
18.	Cirro-strati, chiefly to N. and E. ; hoar-frost.	B
20.	Sheets and patches of woolly cirri.	B
22.	Cirro-strati and patches of cumuli on E. and NE. horizon ; a patch of cirrus to W.	W
0.	Loose cumuli to S. and on N. horizon.	W
2.	Loose cumuli.	W
4.	Masses of cumuli near horizon ; cirrous haze to E. and S.	W
6.	Loose cumuli.	W
8.	Id. ; very faint Auroral light, low on N. horizon.	W
10.	Auroral light to N., more distinct 10 ^m ago, when it was an arch 8° altitude, stretching from NW. to N. ; no Aurora was visible at 9 ^h .	W
18.	Hoar-frost.	B
20.	Cirro-cumuli and linear cirri to SW.	B
22.	Cirro-cumuli, fine woolly linear, and mottled cirri + loose cumuli on SE. horizon ; cirrous haze on horizon.	W
0.	Masses of scud : large cirro-cumuli + linear cirri and cirro-strati to E. and SE. ; cirrous haze to S.	W
2.	Thick mass of cirrous clouds and haze, with thick linear cirri, the motion scarcely perceptible + masses of	W
4.	Patches of scud + very thick woolly and diffuse cirri obscuring the sun. [scud to S. and SE.	B
6.	Very thick, homogeneous cirrous mass.	B
8.	Hazy clouds.	W
10.	Id.	W
18.	Very dark ; light rain.	B
20.	Scud ; light rain.	B
22.	Loose scud ; drizzle ; Scotch mist.	W
0.	Id.	W
2.	Scud and loose cumuli ; breaking to E.	W
4.	Loose scud : woolly cirri + diffuse cirri to W.	B
6.	Scud.	W
8.	Id. ; occasional slight showers.	W
10.		W

Göttingen Mean Time of Observation.			BARO- METER Corrected.	THERMOMETERS.				RAIN GAUGE.	ANEMOMETER.			Clouds moving from	Quan- tity of Clouds.
				Dry.	Wet.	Diff.	Max. and Min.		Pressure.		Direction of Wind.		
									Max.	Pres.			
d.	h.	m.	in.	°	°	°	°	in.	lbs.	lbs.		0-10.	
Oct.	29	0 0	29.051	48.2 39.5	0.117	5.7	4.3	SW.		
		2 30	29.146			6.1				
		18 0	29.364	30.7	30.0	0.7			6.0	0.0		6.0	
		20 0	355	30.0	29.4	0.6			0.0	0.0	SW by S.	9.5	
		22 0	348	33.0	31.8	1.2	44.0 26.4		0.0	0.0		10.0	
Oct.	30	0 0	317	35.7	32.6	3.1		0.007	0.0	0.0		10.0	
		2 0	268	36.8	34.9	1.9			0.0	0.0		10.0	
		4 0	219	36.9	36.0	0.9			0.0	0.0		10.0	
		6 0	170	37.2	37.0	0.2			0.3	0.3	NE.	10.0	
		8 0	118	37.9	37.6	0.3			0.3	0.1	NNE.	10.0	
		10 0	090	37.3	37.2	0.1			0.3	0.1	NNW.	10.0	
		18 0	29.105	32.7	32.0	0.7			0.3	0.0		2.0	
		20 0	175	31.0	37.8		0.1	0.0		0.5	
		22 0	242	33.0	32.5	0.5	28.3		0.1	0.1	SW by W.	0.5	
Oct.	31	0 0	280	39.0	37.7	1.3		0.452	0.3	0.3	SW by S.	0.5	
		2 0	307	42.1	40.0	2.1			0.3	0.2	SW by S.	1.3	
		4 0	332	41.8	40.0	1.8			0.2	0.0		2.0	
		6 0	363	34.0	33.6	0.4			0.0	0.0		3.0	
		8 0	373	29.0			0.0	0.0		1.0	
		10 0	371	29.3			0.0	0.0	NE : SSW.	5.0	
		18 0	29.411	28.6	28.1	0.5			0.0	0.0		3.0	
		20 0	445	31.7	31.3	0.4	44.2		0.0	0.0	SE.	9.0	
		22 0	495	32.4	32.1	0.3	26.3		0.0	0.0	SE by E : SE ?	8.0	
Nov.	1	0 0	519	37.2	36.0	1.2		0.006	0.0	0.0	SE by E : S by W.	7.5	
		2 0	530	42.1	40.4	1.7			0.0	0.0	S by E : S by W.	5.5	
		4 0	551	42.8	40.7	2.1			0.0	0.0	S : S by W.	8.5	
		6 0	579	36.7	36.4	0.3			0.0	0.0		5.0	
		8 0	605	30.1	30.0	0.1			0.0	0.0	S by W.	5.0	
		10 0	631	30.8			0.1	0.0	S ½ W.	9.0	
		18 0	29.650	33.8	33.6	0.2			0.0	0.0		10.0	
		20 0	660	33.8	33.5	0.3	44.0		0.0	0.0	S.	8.0	
		22 0	679	37.7	37.5	0.2	29.5		0.0	0.0	W : SSE.	8.5	
Nov.	2	0 0	687	42.5	42.4	0.1		0.010	0.0	0.0	S by E.	8.0	
		2 0	664	44.0	42.3	1.7			0.0	0.0	S.	9.9	
		4 0	647	44.0	42.8	1.2			0.0	0.0	ENE.	9.9	
		6 0	640	41.9	41.2	0.7			0.0	0.0	SE.	10.0	
		8 0	624	41.9	41.1	0.8			0.0	0.0	SE.	9.8	
		10 0	604	35.4	35.4	0.0			0.0	0.0		0.2	
		18 0	29.449	31.0			0.0	0.0		0.8	
		20 0	431	33.1	32.8	0.3	45.4		0.0	0.0	SSE : SSE.	2.5	
		22 0	404	36.5	36.5	0.0	27.6		0.2	0.0	SSE : S.	9.8	
Nov.	3	0 0	367	39.7	39.5	0.2		0.003	0.2	0.0	W by S.	10.0	
		2 0	316	44.8	43.3	1.5			0.1	0.0	S by E : S ½ W.	7.0	
		4 0	274	42.0	41.7	0.3			0.0	0.0	S by W.	3.0	
		6 0	259	37.6	37.5	0.1			0.0	0.0	S.	4.0	
		8 0	255	39.3	38.9	0.4			0.0	0.0	SW.	9.0	
		10 0	244	41.0	40.6	0.4			0.1	0.0	SSW.	9.0	
		18 0	29.107	48.7	47.0	1.7			1.7	1.4	SSE.	10.0	
		20 0	124	48.9	47.2	1.7	45.6		2.4	0.8	SSW.	9.0	
		22 0	251	46.3	44.8	1.5	34.1		2.1	0.5	SSW ½ W.	0.8	

Nov. 3^d 0^h 40^m. New floss silk put upon the wet bulb thermometer, the other having become quite green.
 Nov. 3^d 20^h. The reading of the barometer is perhaps 0.05 inch too low.

SPECIES OF CLOUDS, &c.	Observer's Initial.
h.	
18. Sky nearly covered with thin clouds and haze.	W
20. Loose cirro-cumuli, woolly cirri, and cirrous haze.	W
22. Dense cirro-stratus; patch of scud to SE.; patch of sky; light mist.	B
0. Homogeneous cirrous mass.	B
2. Id.; light rain.	B
4. Id.; id.	W
6. Scud + homogeneous mass of clouds; light rain.	W
8. Light rain.	W
10. Continuous rain.	B
18. Clouds to SE.	W
20. Cirri and cirro-strati on E. horizon. A large flock of wild geese seen.	W
22. Id.	B
0. Id.	B
2. Loose cumuli to N. and W.: diffuse cirri. [E. horizon.	B
4. Loose cumuli to S., lately covering the sky: light cirri, moving quickly + cirrous haze and cirro-strati on	W
6. Woolly and diffuse cirri + cirrous haze on horizon.	W
8. Cirro-strati to SE.	W
10. Large woolly cirro-cumuli: diffuse cirri, becoming haze.	B
18. Scud to E.	W
20. Cirrous scud, moving very slowly + patches of cirro-stratus.	W
22. Loose cirro-cumuluous cumuli: varieties of cirri, becoming haze to N. and E.	B
0. Cirro-cumuluous scud: woolly, linear, flame, and diffuse cirri.	B
2. Id.: id.	B
4. Loose cumuli: reticulated and linear cirri.	W
6. Linear and diffuse cirri; loose cumuli round the horizon.	W
8. Large woolly cirro-cumuli + patches of cirri.	W
10. Id.	B
18. Quite overcast; a streak of light to E.	W
20. Cirro-cumulo-strati + cirro-strati to E.	W
22. Thin smoky scud: cirro-cumulo-strati.	B
0. Woolly cirro-cumuli + cumuli on N. horizon; dark and hazy, with scud to E.	B
2. Scud.	B
4. Two strata of scud + cumuli on E. horizon; haze on horizon.	W
6. Scud; slight fog.	W
8. Scud and loose woolly cirro-cumuli.	W
10. Patches of scud and cirro-strati on horizon.	B
18. Clouds on E. horizon. 18 ^h 28 ^m . A meteor was seen moving from about 30° to the S. of the zenith towards E. by S., it disappeared at an altitude of about 10° above the SE. point of the horizon, leaving a narrow train of sparks; it was of a bright white colour, apparently about 10' to 15' in diameter (about the size of a cricket-ball): only about 30° of its course was seen.	W
20. Loose scud: cirro-cumuli and cirro-strati to E.	W
22. Thin scud: dense semifluid-like cirro-stratus over the sky.	B
0. Id.: id. See note below.	B
2. Scud: large woolly cirro-cumuli + cirro-strati to E.	B
4. Woolly, mottled, and dense diffuse cirri + cirro-strati on horizon all round; dark cirro-strati on E. horizon.	W
6. Loose cirro-cumuli + diffuse cirri to W.; cirro-strati round horizon; slight fog on the ground.	W
8. Scud.	W
10. Sheets of cirrous haze or thin cirro-strati; lunar corona and portion of a halo.	B
18. Scud; dark to NW.	W
20. Loose scud: large woolly cirro-cumuli and woolly cirri.	W
22. Id. + cirro-strati and cirrous haze to E.	B

Nov. 3^d 0^h 40^m. Quite calm. A sound heard to E., gradually increasing in intensity, and then gradually subsiding, like a strong wind blowing through a mass of leafless trees. At 52^m Kelso town clock (4 miles distant) was heard *very distinctly* to strike 12 o'clock.

Göttingen Mean Time of Observation.			BARO- METER Corrected.	THERMOMETERS.				RAIN GAUGE.	ANEMOMETER.			Clouds moving from	Quantity of Clouds.
				Dry.	Wet.	Diff.	Max. and Min.		Pressure.		Direction of Wind.		
									Max.	Pres.			
Nov. 4	d. h. m.		in.	°	°	°	°	in.	lbs.	lbs.		0-10.	
	4 0 0		29.310	53.2	48.9	4.3		0.008	1.4	1.1	SSW.	SW : SW by S.	2.5
	2 0		347	53.3	48.8	4.5			1.4	0.9	SSW.	SW by S.	4.0
	4 0		397	51.9	48.0	3.9			1.8	1.1	SSW ½ S.	SW by S.	3.0
	6 0		441	48.7	45.9	2.8			1.5	0.5	SSW.	SW by S.	7.5
	8 0		488	46.0	45.0	1.0			0.5	0.1	SSW.		7.0
	10 0		562	41.0	40.8	0.2			0.2	0.0	SSW.	SW : SW.	8.8
Nov. 5	0 10		29.779	54.5 30.8	0.029	0.1				
	18 0		29.347	48.7	47.5	1.2			4.5	0.8	SSW.	SSW ?	10.0
	20 0		361	48.3	47.0	1.3			2.8	1.0	SW ½ W.	W by S : WSW : SW.	9.0
	22 0		371	49.7	47.6	2.1	47.0		0.8	0.5	SW ½ W.	SW ? : SW by W.	4.0
Nov. 6	0 0		417	50.8	47.1	3.7	34.8		1.2	0.4	SW ½ S.	WSW : SW by W.	8.0
	2 0		441	50.7	45.9	4.8		0.056	2.0	0.9	SW.	W by S.	2.0
	4 0		484	48.3	43.1	5.2			1.7	0.9	SW by W.	W by S.	1.5
	6 0		526	42.9	41.0	1.9			1.0	0.3	SW.	WSW ½ W.	4.0
	8 0		511	43.1	40.9	2.2			1.7	0.9	SW by W.		0.5
	10 0		470	43.0	40.9	2.1			1.0	0.4	SW ½ S.		10.0
	18 0		29.082	44.2	43.2	1.0			3.3	0.0			10.0
	20 0		135	45.6	43.9	1.7			0.4	0.3	W by S.	WNW : WNW.	1.5
	22 0		190	46.2	43.1	3.1	51.4		1.4	1.0	W.	W ½ N.	2.0
Nov. 7	0 0		217	47.6	41.9	5.7	40.7		2.9	3.8	W.	W by N.	0.3
	2 0		257	45.3	42.2	3.1		0.019	4.2	0.5	WSW.	W.	2.0
	4 0		277	43.3	41.3	2.0			1.7	1.7	WSW.	W.	7.0
	6 0		293	37.9	36.5	1.4			1.0	0.1	SW.	W ?	0.5
	8 0		286	40.8	39.2	1.6			1.6	0.2	SSW ½ W.	W by S.	8.0
	10 0		249	41.0	39.6	1.4			1.0	1.1	SW.	W.	5.0
	18 0		29.152	36.0	35.7	0.3			2.9	0.1	SW.	WSW.	9.3
	20 0		174	36.2	34.4	1.8			0.6	0.3	W by S.		0.3
	22 0		189	37.3	34.9	2.4	48.5		0.9	0.3	WSW.		0.3
Nov. 8	0 0		247	40.0	36.0	4.0	34.0		2.2	1.8	NW.	WNW.	1.0
	2 0		288	40.8	36.1	4.7		0.000	3.4	0.9	NW by N.	NW by N.	2.0
	4 0		356	37.6	33.0	4.6			3.0	0.6	NNW.		0.5
	6 0		435	34.4	31.0	3.4			1.2	0.8	NW by N.	NW.	0.5
	8 0		503	34.5	31.0	3.5			0.7	0.6	NW by W.		0.8
	10 0		578	34.0	30.4	3.6			1.8	0.2	NW by W.	NNW.	0.5
	18 0		29.693	31.3	30.7	0.6			0.7	0.4	NW ½ W.	N by W.	0.8
	20 0		722	30.0	29.1	0.9			0.6	0.1		NNW.	3.0
	22 0		717	30.0	41.2		0.2	0.1	WNW ½ N.	N by W.	3.0
Nov. 9	0 0		696	37.0	33.1	3.9	27.5		0.2	0.0		NW.	8.0
	2 0		631	37.6	33.6	4.0		0.000	0.0	0.0		NW : NW.	4.0
	4 0		568	35.2	32.7	2.5			0.2	0.0		NW.	9.8
	6 0		526	33.4	31.5	1.9			0.1	0.0	SSW ?		10.0
	8 0		458	33.9	32.0	1.9			0.0	0.0			10.0
	10 0		372	35.0	32.8	2.2			0.2	0.0	S by E.		10.0
	18 16		29.156	37.5	37.0	0.5			0.5	0.0	S ?		10.0
	20 0		175	37.2	37.1	0.1			0.0	0.0			10.0
	22 0		206	38.6	38.4	0.2	38.7		0.0	0.0		SSW.	9.8
Nov. 10	0 0		249	39.7	39.4	0.3	32.7		0.0	0.0			10.0
	2 0		300	39.7	39.4	0.3		0.378	0.0	0.0		E.	10.0
	4 0		335	40.9	40.5	0.4			0.0	0.0			10.0
	6 0		410	39.1	39.0	0.1			0.0	0.0			10.0

SPECIES OF CLOUDS, &c.

Observer's
Initial.

- | | | |
|-----|--|---|
| h. | | |
| 0. | Scud in eddies turning to N.: cirrus-edged cumuli and cumulo-strati; a stratum of cumuli extending from SSW. to ENE., which is scud beneath moving in different directions; splendid solar rays cross the notches of the clouds reaching about 70° towards the zenith. | B |
| 2. | Loose cumuli and scud + ranges of cumuli. | B |
| 4. | Id. + id. | W |
| 6. | Id. | W |
| 8. | Id.; passing showers. | B |
| 10. | Masses of scud, moving quickly: patches of mottled cirri. | B |
| 18. | Scud. | B |
| 20. | Id., moving very quickly: cirro-cumulous scud, moving very slowly: woolly, mottled, and diffuse cirri. | B |
| 22. | Loose cumuli on NE. and S. horizons: large woolly cirro-cumuli. | W |
| 0. | Scud: large woolly cirro-cumuli + cirro-strati on E. horizon. | W |
| 2. | Scud and loose cumuli. | W |
| 4. | Loose cumuli to N. + cumulo-strati on S. horizon. | W |
| 6. | Scud + cumuli on S. horizon; a few drops of rain. | W |
| 8. | Cirri and patches of scud. | W |
| 10. | Sky covered with thin misty scud; faint lunar halo shortly after this about 20° radius. | W |
| 18. | Homogeneous scud; light drizzle. | B |
| 20. | Thick scud, chiefly to E.: patches of cirro-strati to W. | B |
| 22. | Scud and loose cumuli. | W |
| 0. | Masses of loose cumuli. | W |
| 2. | Masses of woolly cirro-cumuli and cirri + loose cumuli and scud near S. and NW. horizon. | W |
| 4. | Scud + cirro-strati and cumuli on horizon; rainbow. | B |
| 6. | Scud to W. | B |
| 8. | Scud; occasional showers. | W |
| 10. | Large woolly cirro-cumuli. | B |
| 18. | Large thin woolly cirro-cumuli + scud passed off to W. with light rain. | B |
| 20. | Scud and cirro-strati on E. horizon. | B |
| 22. | Cumuli on NE. horizon; loose cumuli on Cheviot. | W |
| 0. | Loose cirro-cumuli and cirro-strati + cumuli on NE. and SE. horizon. | W |
| 2. | Cumulo-strati round horizon + cirro-strati to S. | W |
| 4. | Loose cumuli round horizon; a shower of snow? passed along to the N. and E. half an hour ago. | W |
| 6. | Masses of scud and loose cumuli. | W |
| 8. | Loose cumuli. | W |
| 10. | Patches of scud. | W |
| 18. | Scud + cirro-strati to E. | B |
| 20. | Loosely mottled cirri and cirrous scud. | B |
| 22. | Woolly, linear, and mottled cirri + scud and loose cumuli to SE. | W |
| 0. | Woolly cirri and loose cirro-cumuli + patches of scud; cirro-strati on horizon. | W |
| 2. | Woolly and flame cirri, cirrous haze and cirro-strati: lines of patches of cumuli to N. | W |
| 4. | Thick woolly cirro-cumuli; when it became overcast about an hour ago, the clouds were very fine cirro-cumuli which gradually became thicker and larger; they radiate from NNW.; masses of cirri on E. horizon. | W |
| 6. | Dense cirro-stratus. | B |
| 8. | Nearly homogeneous. | W |
| 10. | Thick mass of clouds; a few flakes of snow. | W |
| 18. | Light rain. | B |
| 20. | Id. | B |
| 22. | Woolly cirri, cirrous haze and cirro-cumuli; moving very slowly + loose scud and mist to N. | W |
| 0. | Dense cirrous clouds; foggy. | W |
| 2. | Id.; scud occasionally. | W |
| 4. | Id. | W |
| 6. | Id. | B |

Göttingen Mean Time of Observation.			BARO- METER Corrected.	THERMOMETERS.				RAIN GAUGE.	ANEMOMETER.			Clouds moving from	Quan- tity of Clouds.
				Dry.	Wet.	Diff.	Max. and Min.		Pressure.		Direction of Wind.		
									Max.	Pres.			
Nov. 10	d. 8 0 h. 10 0 m. 18 0 20 0 22 0	29-471 524 29-710 766 823 866 877 917 941 957 980	39.3 38.9 44.3 44.0 46.1 47.6 48.0 45.6 43.4 42.8 41.1	39.1 38.8 44.0 43.3 45.2 45.7 46.3 43.8 42.0 41.7 39.9	0.2 0.1 0.3 0.7 0.9 1.9 1.7 2.8 1.4 1.1 1.2	41.6 37.5	0.028	0.0 0.0 0.2 0.3 0.4 0.5 0.5 0.3 0.1 0.0	0.0 0.0 0.0 0.1 0.2 0.1 0.0	N ? NNW. NE by N. NNE. NE by N. NE by N.	NNE. NNE : NNE. NE. NE. ENE. ENE. SSE.	0-10. 10.0 10.0 10.0 9.5 9.8 10.0 9.5 10.0 10.0 10.0 8.0	
Nov. 12	0 0 18 0 20 0 22 0	48.6 33.2	0.3	0.7 0.0 0.1 0.2	0.0 0.0 0.0 0.1		W. SW. SW. SW.	9.8 10.0 4.0 1.5	
Nov. 13	0 0 2 0 4 0 6 0 8 0 10 0 18 0 20 0 22 0	968 970 971 986 996 995 30-013 045 073	42.6 44.7 41.4 38.9 38.0 37.1 31.0 30.3 35.0	41.1 42.9 40.0 38.1 37.4 35.9 ...	1.5 1.8 1.4 0.8 0.6 1.2 ...	43.3 38.5	0.035	0.2 0.2 0.2 0.3 0.2 0.3 0.1	0.1 0.2 0.1 0.0 0.0	SSW ? SSW. S by W. S by W. SW by S. SW ½ S.	SW. WNW. WNW. WNW. WNW. NW. NNE.	3.0 0.3 6.0 9.8 0.5 8.0 3.0 0.5 10.0 10.0	
Nov. 14	0 0 2 0 4 0 6 0 8 0 10 0 18 35 20 0 22 0 0 0 2 0 4 0 6 0 8 0 10 0	091 092 095 116 145 143 29-993 961 907 857 757 652 616 661 746	40.8 42.0 42.0 40.9 32.8 34.2 34.3 36.9 37.4 39.1 37.6 39.6 42.4 43.0 38.4	38.1 39.0 38.9 38.3 32.2 34.0 33.4 34.9 38.9 38.9 37.3 39.0 41.8 41.3 36.9	2.7 3.0 3.1 2.6 0.6 0.2 0.9 2.0 0.2 0.2 0.3 0.6 0.6 1.7 1.5	47.2 28.5	0.000	0.3 1.0 1.0 0.6 0.3 0.0	0.2 0.2 0.2 0.5 0.2 0.0	N by W. N by W. N ½ W. N by W. NNW. NNW.	NE. NNE. N by E.	1.3 3.0 ...	
Nov. 15	0 0 2 0 4 0 6 0 8 0 10 0 18 0 20 0 22 0 0 0 2 0 4 0 6 0 8 0 10 0	880 837 809 787 726 693 29-829 871 896 880 837 809 787 726 693	39.8 42.7 39.7 36.8 38.0 39.9 34.2 32.6 35.1 35.1 42.7 39.7 36.8 37.5 39.0	37.9 40.5 38.0 36.0 37.5 39.0 32.6 31.9 34.5 37.9 40.5 38.0 36.0 37.5 39.0	1.9 2.2 1.7 0.8 0.5 0.9 1.6 0.7 0.6 1.9 2.2 1.7 0.8 0.5 0.9	44.1 31.3	0.200	0.1 0.1 0.2 0.2 0.1 0.5 0.2 0.0	0.0 0.0 0.0 0.0 0.0 0.0	SSW. SSW. SW by S. SW by S. SW by S. SW by S. W. NNW. NNW ? NNW.	NNW. NNW. N by W.	10.0 10.0 10.0 10.0 10.0 10.0 0.3 9.8 10.0 9.8 10.0 3.0 5.0 10.0 9.8	
Nov. 16	18 0 20 0 22 0	29-381 339 288	47.6 47.8 49.2	45.7 46.8 47.4	1.9 1.0 1.8	42.7 36.5		3.0 2.9 3.9	4.0 1.0 1.2	SSW ½ W. SW by S. SSW.	SW. SW by S : SW.	10.0 10.0 10.0	

SPECIES OF CLOUDS, &c.

Observer's
Initial.

h.		
8.	Dense cirrous clouds.	W
10.	Id.	W
18.	Light rain.	B
20.	Thin scud.	B
22.	Id. : thicker scud.	W
0.	Scud.	W
2.	Id. and loose cumuli.	W
4.	Id.	W
6.	Id.	W
8.	Id.	W
10.	Cirro-cumulous scud.	W
18.	Thin scud + large cirro-cumuli.	W
20.	Scud and large woolly cirro-cumuli.	W
22.	Loose large cirro-cumuli.	B
0.	Id.	W
2.	Loose cumuli.	W
4.	Patches of scud + mottled cirro-strati to NW. ; cirro-strati and cirrous haze on horizon.	W
6.	Scud and loose cumuli + cirro-strati to NW.	W
8.	Sky to NW. ; an Aurora seen beyond the clouds, no streamers or corruscations visible.	W
10.	The Aurora has disappeared.	W
18.	Scud.	W
20.	Thin cirro-cumulo-strati + cumuli to E.	W
22.	Cumuli to E. ; patches of scud to N. and S.	B
0.	Patches of scud + cumuli to E.	B
2.	Scud and cumuli.	W
4.		W
6.	Scud and loose cumuli.	W
8.	Cirro-strati ? to N.	B
10.	Sheets of cirro-strati ? ; faint Auroral light to NNW ?	B
18.	Homogeneous.	W
20.	Dense mass of cirro-cumuli lying in strata and ridges N. and S., moving very slowly ; the clouds tinged with red to E. ; in a few minutes the clouds to E. are of a very bright golden yellow, and slightly tinged with it all round the horizon.	W
22.	Gray scud to W. : a homogeneous mass of clouds, milky, cirrous, mottled, &c., cirrous scud.	B
0.	Patches of loose scud + homogeneous mass of clouds above ; light rain.	W
2.	Id. id. ; heavy rain.	B
4.	Two currents of scud ; light rain.	W
6.	Scud ; light rain occasionally.	W
8.	Scud ?	B
10.	Sheets of cirro-strati.	B
18.	Patches and streaks of light clouds.	W
20.	Cirro-cumulo-strati + cirro-strati on E. horizon ; red to SE.	W
22.	Dark, mottled, loose cirro-cumuli + dense cirro-stratus.	B
0.	Large woolly cirro-cumuli + large feathers of cirri ; hazy to N. and E. ; sky milky.	B
2.	Thick homogeneous mass of cirri ; faint solar halo about 20° radius.	B
4.	Cirro-cumuli + cirro-strati in thick cirrous haze on horizon.	W
6.	Cirro-strati and cirrous haze.	W
8.	Dark ; light rain.	B
10.	Cirrous clouds and haze.	B
18.	Thick scud.	W
20.	Scud ; a few drops of light rain.	W
22.	Thin scud : thick woolly cirro-cumuli ; cirrous haze ; blue cirro-strati reposing in the gray mass to E. ; a few drops of rain.	B

Göttingen Mean Time of Observation.			BARO- METER Corrected.	THERMOMETERS.				RAIN GAUGE.	ANEMOMETER.			Clouds moving from	Quan- tity of Clouds.
				Dry.	Wet.	Diff.	Max. and Min.		Pressure.		Direction of Wind.		
									Max.	Pres.			
Nov. 17	d. h. m.	in.	°	°	°	°	in.	lbs.	lbs.			0-10.	
	0 0	29.234	50.9	49.0	1.9		0.037	2.5	1.4	SSW. v.	SW by S.	10.0	
	2 0	189	50.6	47.7	2.9			2.0	2.3	SSW.	WSW.	4.0	
	4 0	191	45.6	42.5	3.1			2.4	0.3	SW by S.	WSW.	0.8	
	6 0	196	39.9	37.6	2.3			0.2	0.1	SW ?		0.3	
	8 0	188	38.9	37.8	1.1			0.3	0.3	SSW.	W.	2.0	
	10 0	167	37.9	37.2	0.7			0.3	0.2	SW by S ?		0.5	
	18 0	29.087	37.0	35.4	1.6			1.4	0.4	SW.		0.0	
	20 0	076	36.6	36.0	0.6			1.9	0.3	SW ½ S.	SW.	8.0	
	22 0	070	37.7	37.0	0.7	51.0		1.6	0.4	SSW.	SW : SW by W.	2.5	
Nov. 18	0 0	043	41.3	39.2	2.1	32.4		2.1	0.6	SSW.		1.5	
	2 0	038	41.0	39.2	1.8			4.5	0.7	SSW.	SW.	4.0	
	4 0	041	40.0	38.0	2.0			2.6	0.7	SSW.		0.5	
	6 0	050	37.0	35.6	1.4			1.3	0.6	SSW.		4.0	
	8 0	069	35.9	35.0	0.9			1.4	0.2	SSW.		0.1	
	10 0	075	35.8	35.2	0.6			1.1	0.1	SSW.		0.8	
Nov. 19	0 ? 0	29.35	41.9		0.8					
	18 0	28.987	41.7	41.0	0.7	30.3		2.6	0.1	E by N ?		10.0	
	20 0	28.951	42.0	41.5	0.5			0.5	0.2	NNE ?	E.	10.0	
	22 0	28.983	42.9	42.7	0.2	45.8		0.2	0.0		NW.	10.0	
Nov. 20	0 0	29.065	39.6	38.9	0.7	35.9		5.1	1.7	NW.	NW.	10.0	
	2 0	29.133	43.0	40.6	2.4		0.146	2.6	1.3	NW ½ W.	NW : W.	8.0	
	4 0	29.197	42.8	39.3	3.5			2.5	0.9	W by N.		1.0	
	6 0	29.235	39.8	37.0	2.8			0.7	0.3	W by N.		1.5	
	8 0	29.233	36.0	35.0	1.0			0.3	0.1	SW ?		8.5	
	10 0	29.183	40.3	39.8	0.5			0.1	0.0			9.5	
	18 0	29.105	40.2	39.9	0.3			0.2	0.0		W ?	6.0	
	20 0	29.115	42.2	41.8	0.4			0.4	...		W.	3.0	
	22 0	29.142	42.0	39.9	2.1	45.1		1.0	0.2	SW ½ W.	W : W.	3.0	
Nov. 21	0 0	29.158	42.9	41.0	1.9	35.5		0.5	0.5	SW ½ S.	W.	3.0	
	2 0	29.155	42.3	40.9	1.4		0.020	0.3	0.2	SSW.	W by N.	9.0	
	4 0	29.112	41.6	40.1	1.5			0.2	0.0			9.8	
	6 0	29.046	41.0	40.1	0.9			0.2	0.0			10.0	
	8 0	28.906	40.8	40.5	0.3			0.2	0.0			10.0	
	10 0	28.738	50.0	49.8	0.2			3.6	3.8	SSW.		10.0	
	18 0	28.658	46.3	44.2	2.1			6.2	1.2	SW by W.	W ?	3.0	
	20 0	28.647	46.8	44.7	2.1			4.6	2.4	WSW ½ S.	WSW.	9.5	
	22 0	28.706	46.0	44.1	1.9	51.5		4.1	1.6	SW by W.	W by S.	9.8	
Nov. 22	0 0	28.788	44.3	40.8	3.5	39.4		7.2	3.2	NW. v.	WNW.	9.8	
	2 0	29.060	44.9	40.9	4.0		0.460	4.3	2.5	NW ½ N.	WNW.	9.0	
	4 0	29.158	42.7	38.8	3.9			2.0	1.7	W by S.	WNW.	0.8	
	6 0	29.246	37.0	36.0	1.0			1.0	0.1	WSW.		0.3	
	8 0	29.293	36.7	35.6	1.1			0.6	0.5	SW.		0.3	
	10 0	29.302	37.8	36.3	1.5			0.8	0.6	SW ½ W.		0.2	
	18 0	29.228	35.9	35.8	0.1			0.2	0.1	SW ?		2.0	
	20 0	220	36.8	36.2	0.6			0.3	0.0	SSW ?	SW : S ?	10.0	
	22 0	201	35.9	35.1	0.8	46.3		0.0	0.0		SW by S.	9.0	
Nov. 23	0 0	180	38.7	38.1	0.6	28.8		0.0	0.0		SW.	9.8	
	2 0	153	39.0	38.1	0.9		0.007	0.0	0.0		SW ?	10.0	
	4 0	127	38.1	37.6	0.5			0.0	0.0			10.0	
	6 0	139	36.9	36.3	0.6			0.0	0.0			10.0	
	8 0	161	36.8	36.0	0.8			0.0	0.0			2.0	
	10 0	184	33.0	32.9	0.1			0.0	0.0			2.0	

SPECIES OF CLOUDS, &c.

Observer's
Initial.

h.	
0. Scud +- dense cirro-stratus; light drizzle.	B
2. Id. +- fine feathers of beautifully mottled cirri pointing NNE.; cumuli and cirrous haze to E.	B
4. Masses of loose-edged cumuli.	W
6. Scud to W.; patches of cirri.	W
8. Cirrous scud.	B
10. Cirro-strati.	B
18. Quite clear.	W
20. Loose scud; light showers.	W
22. Id.: diffuse cirri +- nimbi to S. with fine cirrous crowns; cirro-strati to E.	B
0. Nearly as at 22 ^h ; cumuli to E.	B
2. Cirrous-crowned nimbi and scud, masses of woolly and diffuse cirri.	B
4. Cumuli; nimbi and diffuse cirri on horizon.	W
6. Thin scud; cumuli on horizon.	W
8. A patch of scud to NW.; passing showers and masses of nimbi.	B
10. Cirrous scud?	B
18. Very dark; a few drops of rain.	B
20. Scud; light rain.	B
22. Id.; id.	W
0. Id. +- homogeneous above; light rain.	W
2. Lines of patches of loose scud: woolly cirro-cumuli and cirri +- loose cumuli to S.	W
4. Cirro-cumuli, cirro-strati and cirrous haze to E.	B
6. Scud to SW.	B
8. Scud.	W
10. Id.	W
18. Id.	B
20. Scud and nimbi; passing showers.	B
22. Masses of scud and loose cumuli: fine cirro-cumuli +- cirro-strati on horizon; cumuli on Cheviot.	W
0. Linear cirri and patches of cirro-cumuli +- thick cirrous haze and diffuse cirro-strati; masses of loose cumuli to NW.	W
2. Thick, woolly, and diffuse cirri and cirrous haze +- mass of scud to NW.; cirro-strati on horizon.	W
4. Thick, dense, cirro-cumulous mass, like a semifluid.	W
6. Light rain.	B
8. Rain; very dark.	W
10. Light rain; the wind feels very warm.	W
18. Scud.	B
20. Id.; slight drizzle.	B
22. Loose scud +- large cirro-cumuli to S.; slight shower. [much.	W
0. Scud and loose cumuli. At 23 ^h 10 ^m the wind had shifted to WNW. blowing from 4 lbs. to 7 lbs., varying	W
2. Scud, loose cumuli.	W
4. Id., id.	B
6. Cirro-strati on horizon.	B
8. Thin scud.	W
10.	W
18. Sheets of cirrous scud? to E. and S.	B
20. Woolly cirro-cumuli: woolly cirri.	B
22. Woolly cirri and cirro-cumuli +- cirro-strati and cirrous haze.	W
0. Cirrous scud, woolly cirri, and cirro-cumuli, all moving very slowly.	W
2. Masses of scud +- thick cirrous mass.	W
4. Dense cirrous mass.	B
6. Id.	B
8. Clearing off from SW.	W
10. Clouds to E.	W

Göttingen Mean Time of Observation.			BARO- METER Corrected.	THERMOMETERS.				RAIN GAUGE.	ANEMOMETER.			Clouds moving from	Quan- tity of Clouds.	
				Dry.	Wet.	Diff.	Max. and Min.		Pressure.		Direction of Wind.			
									Max.	Pres.				
d.	h.	m.	in.	°	°	°	°	in.	lbs.	lbs.		0-10.		
Nov. 23	18	0	29.253	28.3	28.3	0.0			0.0	0.0			0.3	
	20	0	292	28.9	28.7	0.2			0.0	0.0		W.	4.0	
	22	0	323	32.2	31.8	0.4	39.1		0.0	0.0		SW.	6.0	
Nov. 24	0	0	346	34.2	33.7	0.5			0.0	0.0			3.0	
	2	0	355	36.9	36.0	0.9		0.004	0.0	0.0		WSW.	9.0	
	4	0	368	34.5	34.1	0.4			0.0	0.0		WSW.	7.0	
	6	0	398	30.6			0.0	0.0		WSW.	2.0	
	8	0	428	31.0			0.0	0.0			0.2	
	10	0	460	34.0	32.6	1.4			0.0	0.0			10.0	
	18	0	29.430	29.5			0.0	0.0			2.0	
	20	0	429	29.8			0.0	0.0			10.0	
	22	0	423	33.3	31.6	1.7	37.1		0.0	0.0			10.0	
Nov. 25	0	0	390	34.3	33.6	0.7	27.9		0.0	0.0		W.	9.0	
	2	0	383	36.7	35.6	1.1		0.006	0.0	0.0		S.	9.8	
	4	0	387	35.3	34.7	0.6			0.0	0.0		W.	9.8	
	6	0	364	30.2			0.0	0.0			2.0	
	8	0	366	29.3			0.0	0.0			10.0	
	10	0	339	30.4			0.0	0.0			10.0	
Nov. 26	0	0	37.0		1.0					
		18	0	29.017	50.1	47.8	2.3	26.5	0.274					
		20	0	004	49.9	47.8	2.1			4.3	3.1	SSW.	SW?	3.0
Nov. 27		22	0	007	50.0	47.5	2.5	52.6		4.4	2.4	SSW.	SSW.	9.8
		0	0	009	50.3	47.8	2.5	47.5		4.7	1.6	SSW.	SW.	9.0
		2	0	010	49.4	47.7	1.7		0.121	3.0	1.0	SSW.	SW.	8.0
		4	0	076	49.0	47.3	1.7			1.6	0.7	SSW.	WSW : SW.	9.8
		6	0	133	48.9	46.9	2.0			1.7	0.9	SW.	SW by W : W by S.	9.8
		8	0	199	48.8	46.6	2.2			2.0	1.5	SW ½ S.	WSW.	10.0
		10	0	278	47.8	45.7	2.1			1.8	0.7	SW.	W?	8.0
		18	0	29.623	48.7	46.3	2.4			1.2	0.4	W by S.	W?	1.3
Nov. 28		20	0	682	47.0	45.3	1.7			0.9	0.2	W.		9.0
		22	0	750	48.0	45.8	2.2	51.3		0.3	0.0		W.	7.0
		0	0	759	49.0	45.5	3.5	45.9		0.2	0.0	SSW?	W.	9.8
		2	0	760	47.7	45.9	1.8		0.027	0.7	0.5	WSW?	W.	10.0
		4	0	715	48.5	46.2	2.3			0.9	0.2	WSW?	W.	10.0
		6	0	633	49.6	47.6	2.0			1.2	0.5	SW ½ S.	SW.	10.0
		8	0	576	51.3	50.0	1.3			1.0	2.7	SW.		10.0
		10	0	656	49.7	45.0	4.7			2.1	0.9	SW ½ W.		10.0
Nov. 29		18	0	29.824	46.7	42.0	4.7			4.7	2.7	WNW. v.		0.8
		20	0	29.866	45.1	41.5	3.6			4.5	3.0	WNW.		0.0
		22	9	29.910	45.4	41.3	4.1	52.0		4.2	4.1	WNW.	W.	0.3
		0	0	29.932	46.9	42.2	4.7	44.1		4.8	2.5	NW.		0.3
		2	0	29.979	47.7	42.3	5.4		0.008	4.7	4.3	NW ½ W.		0.3
		4	0	30.044	45.6	41.4	4.2			4.8	1.0	W by S?		0.3
		6	0	30.098	38.5	37.1	1.4			1.4	0.1			3.0
		8	0	30.141	37.0	36.0	1.0			0.2	0.0			0.0
		10	0	30.165	34.0	33.8	0.2			0.1	0.0			0.3
		18	0	30.106	33.0	33.0	0.0			0.1	0.0			0.0
Nov. 30		20	0	30.051	40.3	40.1	0.2			0.1	0.0			10.0
		22	0	30.013	43.8	43.2	0.6	47.5		0.7	0.0			10.0
		0	0	29.934	44.0	43.5	0.5	28.5		0.2	0.1	S by W?		10.0
		2	0	29.850	47.9	47.1	0.8		0.010	0.6	0.2	SSW.		10.0
		4	0	29.766	49.1	48.2	0.9			2.2	1.2	SSW ½ W.	SW.	10.0

SPECIES OF CLOUDS, &c.

Observer's
Initial.

18. Streaks of cirro-strati to N. and S.	B
20. Linear and woolly cirri; smoke shews the wind to be from SSE.	B
22. Woolly and linear cirri and cirrous haze.	W
0. Id. id., cirro-strati; masses of scud on N. horizon.	W
2. Id. id.	W
4. Linear and flame cirri radiating from SW.	B
6. Id.	B
8.	W
10. Sky covered with thin scud.	W
18. Clouds on horizon; cirrous haze.	H
20. Woolly cirri, cirrous haze; cirro-strati to S. and E.	B
22. Thick cirrous mass; shower of snow.	H
0. Large woolly cirro-cumuli, scarcely moving.	W
2. Cirrous scud and loose cumuli.	W
4. Cirrous scud and woolly cirri.	W
6. Cirrous clouds; foggy.	D
8. Thick fog.	B
10. Id.	W
18. Scud.	W
20. Thick scud; sky on NE. horizon.	W
22. Scud, in different strata + woolly cirri; rain, rainbow.	B
0. Scud, woolly and feathered cirri; light rain.	B
2. Thick scud: woolly cirri; drizzle.	B
4. Two currents of scud; shower.	W
6. Scud; light rain.	W
8. Id.	W
10. Cirrous scud.	B
18. Scud.	W
20. Id. + woolly cirri; cirro-strati on E. horizon.	W
22. Id. + cirrous haze, linear cirri, and cirro-strati.	B
0. Id. + cirrous haze covering the sky; the sun shining faintly.	B
2. Id. + dense cirrous mass; occasional drops of rain.	B
4. Id. + id.	W
6. Id. + id.	W
8. Id. id.; light rain.	B
10. Cirrous haze to E.; scud to S.	B
18. Clear.	W
20. Loose scud on S. horizon + cirrous haze on E. horizon.	W
22. Id.	B
0. Scud to SE.	B
2. Id. [scud.	B
4. Mottled, reticulated, and cymoid cirri, with cirrous haze, forming over a great part of the sky; masses of	W
6. Clear.	W
8. Cirrous haze to SW.	B
10. Clear.	B
18. Scud.	W
20. Homogeneous; cirro-strati on E. horizon.	W
22. Thin smoky scud + dense cirrous clouds.	B
0. Id. + id.; light rain.	B
2. Id. + id.	B
4. Loose scud; light drizzle.	W

Göttingen Mean Time of Observation.			BARO- METER Corrected.	THERMOMETERS.				RAIN GAUGE.	ANEMOMETER.			Clouds moving from	Quan- tity of Clouds.
				Dry.	Wet.	Diff.	Max. and Min.		Pressure.		Direction of Wind.		
									Max.	Pres.			
Nov. 30	d. h. m.		in.	°	°	°	°	in.	lbs.	lbs.			0-10.
	6 0		29.720	49.0	48.3	0.7			2.2	0.6	SW.	SW.	10.0
	8 0		719	50.3	49.1	1.2			1.1	0.2			10.0
	10 0		738	48.3	47.6	0.7			0.0	0.0		N.	7.5
	18 0		29.888	33.6	33.0	0.6			0.8	0.0			0.0
	20 0		905	31.6	31.3	0.3	49.9		0.0	0.0			0.3
	22 0		932	34.7	33.9	0.8	30.4		0.0	0.0			10.0
Dec. 1	0 0		926	36.3	35.6	0.7		0.013	0.0	0.0			10.0
	2 0		916	38.5	37.1	1.4			0.0	0.0			9.8
	4 0		919	36.0	35.3	0.7			0.0	0.0		NW.	7.0
	6 0		940	30.0	29.9	0.1			0.0	0.0			0.2
	8 0		939	28.0			0.0	0.0		NNW.	0.3
	10 0		924	27.3	27.1	0.2			0.0	0.0			0.5
	18 0		29.838	32.9	32.2	0.7			0.0	0.0			7.0
	20 0		837	40.9	40.0	0.9	38.8		0.2	0.3	WSW.	WSW?	10.0
	22 0		853	42.7	41.8	0.9	25.3		1.0	1.5	SW ½ W.	WSW : W.	10.0
Dec. 2	0 0		853	45.0	44.2	0.8		0.010	2.0	0.3	SW ½ W.	SW by W : W.	10.0
	2 0		847	46.6	45.2	1.4			0.6	0.6	SW ½ S.	SW by W : WNW.	10.0
	4 0		878	47.6	46.3	1.3			0.6	0.4	WSW.	W : WNW : NW.	8.5
	6 0		912	45.1	44.5	0.6			0.4	0.2	SW ½ S.		1.0
	8 0		955	44.9	43.6	1.3			0.2	0.1	WSW ½ S.	WNW.	1.5
	10 0		995	42.2	41.3	0.9			0.2	0.0		WNW.	2.0
Dec. 3	0 0		48.1		1.9		SW.		
	18 0		29.998	49.9	48.0	1.9	38.2		2.5	0.6	SW ½ S?	W.	10.0
	20 0		30.020	48.8	47.7	1.1			0.6	0.1	SSW ½ W?	W.	10.0
	22 0		30.036	48.8	47.7	1.1	50.2		0.6	0.3	SW ½ S.	W by S : W.	7.5
Dec. 4	0 0		30.029	50.9	49.1	1.8	45.6		0.9	0.3	SW by S.	SW.	9.8
	2 0		29.970	50.7	48.9	1.8		0.000	0.8	0.4	SW ½ S.	SW by W : W by N.	9.0
	4 0		29.932	49.8	48.2	1.6			1.4	0.3	SW ½ S.	SW.	9.8
	6 0		29.903	48.9	46.6	2.3			3.0	0.8	SW. v.	SW by S.	10.0
	8 0		29.859	48.5	46.3	2.2			3.0	0.5	WSW. v.	SW.	9.5
	10 0		29.800	48.6	46.6	2.0			1.9	0.8	SSW ½ W.	SW.	9.8
	18 0		29.555	49.0	46.6	2.4			7.6	4.7	SW. v.	WSW.	9.5
	20 0		488	49.4	46.9	2.5			5.2	3.8	SW. v.	SW.	9.8
	22 0		485	49.3	48.3	1.0	51.5		6.8	2.6	SW.	SW.	10.0
Dec. 5	0 0		476	50.5	47.6	2.9	48.4		3.0	0.8	SW. v.	SW.	9.8
	2 0		465	49.1	45.9	3.2		0.004	3.1	2.1	SW.	WSW : WSW.	9.0
	4 0		462	46.2	43.8	2.4			2.6	1.8	SW.	WSW.	4.0
	6 0		503	44.7	41.0	3.7			4.4	1.9	SW.	WSW.	5.0
	8 0		556	41.8	38.0	3.8			3.9	3.6	SW ½ W.	W.	6.5
	10 0		597	40.4	37.3	3.1			1.9	1.4	SW.	W.	2.0
	18 0		29.683	42.0	39.0	3.0			4.1	1.3	SW. v.	W ½ N.	4.0
	20 0		723	44.5	40.8	3.7			4.1	2.1	W. v.	W ½ N.	9.0
	22 0		762	44.8	40.6	4.2	50.4		5.2	2.3	W.	WNW.	1.0
Dec. 6	0 0		814	43.3	40.7	2.6	38.4		5.5	1.3	W. v.	W by N.	0.5
	2 0		857	46.3	41.3	5.0		0.029	4.8	3.0	W by N.		0.3
	4 0		889	44.3	40.9	3.4			2.2	1.3	SW. v.	WNW.	0.5
	6 0		927	44.9	41.0	3.9			2.1	0.8	SW. v.	W by N.	5.0

SPECIES OF CLOUDS, &c.

Observer's
Initial.

- | | | |
|-----|---|---|
| h. | | |
| 6. | Loose scud ; light drizzle. | W |
| 8. | Id. ; id. | B |
| 10. | Large woolly cirro-cumuli +- cirrous haze to SW. | B |
| 18. | Clear. | W |
| 20. | Cirro-strati and cirrous haze to E. and S. | W |
| 22. | Thick, ribbed, and evenly mottled cirrous clouds, nearly homogeneous. | B |
| 0. | As before, but much thicker. | B |
| 2. | Irregular, hazy, woolly, and linear cirrous mass, with a little hazy sky in zenith ; breaking a little. | B |
| 4. | Cirro-cumuli of all varieties and forms, passing from the finest spots to the largest masses ; some of them hanging like bags, lying in strata, and other forms ; in some places of a bluish-grey, with patches of whitish-yellow +- hazy linear cirri under the cirro-cumuli to NE., radiating from NNW. ; thick and hazy to E. ; feathered and woolly cirri above the cirro-cumuli. | W |
| 6. | Woolly cirri to S. | W |
| 8. | Long ribbons of thin woolly cirri, radiating from WSW., of different lengths, some of them stretching from the WSW. point of the horizon to 45° past the zenith, <i>i.e.</i> 135° ; the whole move from about NNW. ; stars of small magnitude are visible through the strips ; in passing over the moon they cause a small corona. | B |
| 10. | Uncommonly thin haze over the sky ; streaks of ribbon-cirri to E. A beautiful lunar halo 23° radius, the complete breadth of the ring is about 4°. | B |
| 18. | | W |
| 20. | Scud +- cirrous clouds. | W |
| 22. | Scud : cirro-cumuli. Woolly and diffuse cirri cover the whole sky ; strata of loose cirro-cumuli moving slowly : a great band of dense scud with attendant patches of loose thin scud, moving rapidly from WSW., the patches quickest ; the whole issues from a misty mass to SW., the patches moving over all parts of the sky and far below the cirrous clouds. | B |
| 0. | Nearly as before, but the sky is more completely covered by thin smoky scud. | B |
| 2. | Two currents of scud +- cirri. | B |
| 4. | Masses of loose smoky scud in two currents : large loose cirro-cumuli, moving slowly +- cirrous clouds ; bands of cirro-strati and scud near the horizon. | W |
| 6. | Cirri and patches of scud ; lunar corona. | W |
| 8. | Scud +- cirrous haze to E. | W |
| 10. | Id. | B |
| 18. | Scud +- cirrous clouds. | B |
| 20. | Id. | B |
| 22. | Loose scud : linear and mottled cirri. | W |
| 0. | Scud +- cirro-strati to E. | W |
| 2. | Loose scud : large cirro-cumuli. | W |
| 4. | Scud +- linear cirri and cirro-cumuli. | B |
| 6. | Scud +- cirrous clouds. | B |
| 8. | Id. | W |
| 10. | Id., moving rapidly. | W |
| 18. | Scud. | B |
| 20. | Thin detached masses of scud, very low +- the upper scud is red below. | B |
| 22. | Scud +- dense cirrous clouds ; slight drizzle. | W |
| 0. | Patches of scud, cirro-cumulous scud +- the upper mass of cirrous clouds breaking up into woolly and linear cirri and cirrous haze. | W |
| 2. | Masses of scud : woolly, mottled, and diffuse cirri and cirrous haze ; part of a solar halo lately. | W |
| 4. | Scud on horizon ; nimbi to S., with cirrous crowns ; very black to SE ; beautiful strata of cirro-cumuli and mottled cirri, chequered in different ways, the strata lying ENE. to WSW., but passing 20° to the S. of the zenith. | B |
| 6. | Scud. | B |
| 8. | Id. | W |
| 10. | Id. | W |
| 18. | Id. | B |
| 20. | Id. ; light rain. | B |
| 22. | Masses of scud near horizon. | W |
| 0. | Masses of thin scud ; passing showers. | W |
| 2. | Id. ; cirrous haze to E. and N. | W |
| 4. | Masses of scud +- linear cirri to SW., radiating from NNW. ; cirrous haze on N. and E. horizon. | B |
| 6. | Scud +- patches of cirri to SE. | B |

Göttingen Mean Time of Observation.			BARO- METER Corrected.	THERMOMETERS.				RAIN GAUGE.	ANEMOMETER.			Clouds moving from	Quantity of Clouds.
				Dry.	Wet.	Diff.	Max. and Min.		Pressure.		Direction of Wind.		
									in.	lbs.			
Dec. 6	8	0	29.902	46.6	42.8	3.8		in.	4.4	3.9	W.	W by N : NW.	0-10. 7.0
	10	0	940	43.5	40.9	2.6			4.2	0.0		W.	6.5
	18	0	29.790	45.3	43.3	2.0			2.9	1.4	SW $\frac{1}{2}$ S.	SW : WNW.	9.0
	20	0	732	45.1	44.1	1.0			2.1	1.7	SW $\frac{1}{2}$ S.	SW : WNW ?	9.8
	22	0	656	47.3	45.3	2.0	46.3		4.9	3.7	SW. v.	SW : WNW : WNW.	7.0
Dec. 7	0	0	637	48.9	47.0	1.9	42.5	0.182	3.4	1.3	SW $\frac{1}{2}$ W.	W : WNW ?	9.8
	2	0	629	50.1	48.7	1.4			3.2	1.8	SW. v.	W.	10.0
	4	0	556	54.0	50.8	3.2			2.4	1.4	SW. v.	W by S : W.	10.0
	6	0	544	53.6	50.7	2.9			1.9	0.4	SW ?		10.0
	8	0	584	53.6	50.9	2.7			3.8	2.6	SW by W. v.	W by N.	10.0
	10	0	638	52.1	49.2	2.9			2.3	1.4	WSW.	W.	3.0
	18	0	29.837	44.6	41.7	2.9			1.8	0.6	W by S. v.	WNW.	1.5
	20	40	856	45.3	41.9	3.4	53.8		0.6	0.2	WSW ?	WNW.	8.5
	22	0	876	47.0	43.0	4.0	43.5		1.2	1.1	WSW $\frac{1}{2}$ S.	WNW.	9.5
Dec. 8	0	0	888	48.3	44.7	3.6		0.253	2.3	1.0	SW.	W by N.	9.5
	2	0	865	48.2	44.3	3.9			3.2	1.8	WSW.	WNW.	4.0
	4	0	887	48.2	44.3	3.9			1.6	1.1	W by S.	WNW : WNW.	6.0
	6	0	914	47.6	44.6	3.0			1.6	0.3	WSW ?	WNW : WNW.	3.5
	8	0	919	47.0	44.7	2.3			1.4	0.5	W $\frac{1}{2}$ N.	NW.	3.0
	10	0	947	46.7	45.0	1.7			0.6	0.2	W.	NW ?	2.0
	18	0	30.009	43.3	42.9	0.4			0.3	0.0		NW ?	1.3
	20	0	30.016	45.3	44.9	0.4	48.4		0.0	0.0		W.	9.8
	22	0	30.024	47.2	46.0	1.2	41.2		0.0	0.0		SW by W : W.	10.0
Dec. 9	0	0	30.024	48.7	47.6	1.1		0.012	0.2	0.1	WSW $\frac{1}{2}$ S.	SW.	10.0
	2	0	30.002	49.1	47.8	1.3			0.1	0.1	SW $\frac{1}{2}$ W.	SW : W.	10.0
	4	0	29.992	48.3	47.0	1.3			0.0	0.0		W.	9.8
	6	0	29.988	46.6	45.9	0.7			0.0	0.0		W.	10.0
	8	0	29.984	45.3	45.0	0.3			0.0	0.0		W.	9.8
	10	0	29.970	46.0	45.5	0.5			0.0	0.0			10.0
Dec. 10	0	0	49.2		0.0				
							38.7						
	18	20	29.894	44.3	42.4	1.9			0.7	0.1	SW $\frac{1}{2}$ S.	SW : WSW.	4.0
	20	0	29.889	46.9	44.7	2.2			0.2	0.2	SSW $\frac{1}{2}$ W.	SW.	9.8
	22	0	29.916	47.7	46.0	1.7	50.2		0.9	0.0		SW by S.	10.0
Dec. 11	0	0	29.920	49.7	47.4	2.3	43.3		1.1	0.8	SW. v.	SW.	9.8
	2	0	29.935	50.5	47.8	2.7		0.000	1.2	0.2	SW $\frac{1}{2}$ S.	SW.	9.8
	4	0	29.966	48.7	46.9	1.8			0.4	0.2	SW.	SW.	10.0
	6	0	29.986	48.3	46.8	1.5			0.4	0.1	SW $\frac{1}{2}$ W.	SW.	10.0
	8	0	30.023	47.5	46.3	1.2			0.1	0.0		SW.	9.9
	10	0	30.044	44.2	44.0	0.2			0.0	0.0		SW ?	5.0
	18	0	30.123	46.3	45.6	0.7			0.0	0.0			9.8
	20	0	128	43.1	43.0	0.1			0.0	0.0		SW.	2.0
	22	0	152	46.2	45.8	0.4	51.1		0.0	0.0		SW.	9.8
Dec. 12	0	0	151	49.0	47.6	1.4	40.5		0.0	0.2	SSW.	SW.	10.0
	2	0	135	49.1	47.2	1.9		0.000	0.1	0.2	SW $\frac{1}{2}$ S.	SW.	9.8
	4	0	122	47.8	45.8	2.0			0.3	0.1	SW $\frac{1}{2}$ S.	SW.	9.8
	6	0	118	47.0	45.0	2.0			0.5	0.3	SSW.	SW.	10.0
	8	0	129	46.8	43.7	3.1			1.1	0.2	SSW $\frac{1}{2}$ W.		10.0
	10	0	100	47.2	44.8	2.4			0.6	0.2	SSW $\frac{1}{2}$ W.		10.0
	18	0	30.021	47.4	45.6	1.8			2.7	1.5	SW $\frac{1}{2}$ S.	SW ?	10.0

Dec. 6^d 8^h. The reading of the barometer is very doubtful, the observation was evidently hurried, and not entered into the note-book.

SPECIES OF CLOUDS, &c.

Observer's
Initial.

- h.
8. Scud : sheets of cirri, crossed at right angles by linear cirri ; coloured corona about the moon, first yellowish-white, passing into brown, blue, and green successively ; the radius of the outer circle being about 4°. At 8^h 15^m a distinct halo of 20° radius.
10. Scud + diffuse cirri and cirro-strati ; a few minutes ago there were a lunar halo and coloured corona.
18. Masses of thin scud : sheets of cirri ; a coloured lunar corona ; occasional drops of rain.
20. Patches of scud : a thick cirrous mass over most of the sky ; light rain. [slowly.]
22. Small patches of thin scud : cirro-cumulo-strati and cirro-cumuli : woolly and diffuse cirri, moving very
0. Scud : thick cirrous clouds.
2. Id. ; light rain.
4. Two currents of scud.
6. Very thick scud.
8. Scud ; a few drops of rain.
10. Id.
18. Scud + cirri.
20. Id. + linear cirri to E.
22. Id. + id. N.
0. Id. + linear and mottled cirri to SE.
2. Id. + patches of cirri.
4. Id. : beautifully mottled and reticulated cirri in strata radiating from SSE. and WNW.
6. Id. : streak of woolly cirrus.
8. Id. + linear cirri and cirrous haze.
10. Patches of scud + linear cirri, cirro-strati, and cirrous haze ; the linear cirri in short lines pointing SSE. and these in strata lying WNW. to ESE.
18. Scud + cirrous haze all round the horizon. 18^h 30^m. Scud passing over the Moon produces a coloured corona ; yellow, orange, blue, yellowish-green, and orange, are the colours from the Moon outwards ; the extreme radius being 6°.
20. Cirrous scud.
22. Scud : cirrous clouds.
0. Id. + id.
2. Masses of scud : cirrous scud and cirrous clouds.
4. Cirrous scud and woolly cirri, moving very slowly.
6. Id.
8. Id.
10. Overcast.
18. Scud : patches of mottled cirri and cirro-cumuli, moving very slowly.
20. Id. ; clear on E. horizon.
22. Id. [is from S.]
0. Thin scud + mottled, woolly, and diffuse cirri and cirro-strati ; wind in gusts, when blowing strongest it
2. Id. + id.
4. Thick scud.
6. Id.
8. Id.
10. Thin scud + cirro-strati to E.
18. Cirro-cumuluous scud ; cirro-strati to SW.
20. Loose scud, moving quickly ; heavy dew since 18^h.
22. Loose scud ; clouds blue, yellow, and gray.
0. Scud.
2. Id. ; the lowest thinnest and moving quickest.
4. Id. + loose cumuli to S.
6. Id.
8. Id. ; Auroral light ? to NNW.
10. Id. ; very dark.
18. Thick scud.

W
WB
BW
WW
WB
BW
WB
BW
WW
WB
BW
WB
BW
WW
WB
BW
WW
WW
WB
BB
BW
WB
BW
WB
BW
WB
BB
BW
W

Göttingen Mean Time of Observation.			BARO- METER Corrected.	THERMOMETERS.				RAIN GAUGE.	ANEMOMETER.			Clouds moving from	Quan- tity of Clouds.	
				Dry.	Wet.	Diff.	Max. and Min.		Pressure.		Direction of Wind.			
									Max.	Pres.				
Dec. 12	d. 20	h. 0	m. 0	in. 30.022	° 46.9	° 44.0	° 2.9	° 49.3	in. 0.000	lbs. 3.6	lbs. 1.5	SW.	SW.	0-10.
				033	46.7	44.0	2.7	45.5		3.5	1.7	SW ½ S.	SW by W.	10.0
Dec. 13	0	0	0	051	46.7	44.4	2.3			1.6	0.2	SW ½ S.	SW by W.	10.0
				032	46.0	43.8	2.2			2.8	1.6	SW ½ S.	SW : SW ?	7.0
				038	46.0	43.9	2.1			2.1	0.6	SSW ½ W.	SW by W.	9.8
				051	45.7	44.3	1.4			1.8	0.2	SW by S.		10.0
				051	46.0	44.7	1.3			1.2	0.9	SW ½ S.		10.0
				070	47.2	46.3	0.9			2.1	0.3	SW ½ S.		10.0
				30.022	48.4	47.0	1.4			2.3	1.2	SW ½ S.	WSW.	7.0
				30.012	45.9	44.3	1.6			0.8	0.2	SW ½ W.	WSW.	4.0
				30.015	48.3	45.9	2.4	48.2		1.1	0.5	SW. v.	WSW ½ S.	10.0
Dec. 14	0	0	0	29.997	48.9	46.0	2.9	45.2	0.013	2.2	1.7	SW by S. v.	SW by W : WNW.	9.9
				29.948	49.0	46.1	2.9			4.7	2.1	SW. v.	SW by W : WNW.	9.8
				29.935	48.7	45.6	3.1			4.1	1.0	SW ½ S.	WSW ½ W.	8.0
				29.898	49.2	46.0	3.2			2.2	2.2	SW.		4.0
				29.845	48.9	46.6	2.3			5.7	4.8	SW.	W ½ S.	3.5
				29.838	51.0	47.2	3.8			6.1	4.8	SW.	W ½ S.	7.0
				29.744	52.7	49.0	3.7			7.5	4.0	WSW. v.	W ½ N.	9.8
				739	53.0	49.4	3.6			5.5	5.2	W. v.	W.	8.0
				793	49.7	49.0	0.7	49.0		3.4	1.8	W. v.	W : W.	9.5
Dec. 15	0	0	0	846	48.7	46.2	2.5	48.2 ?	0.000	2.8	0.8	W.	W ½ N.	9.8
				854	47.1	44.6	2.5			2.1	1.1	W by N ?	W by N.	8.5
				869	45.8	43.1	2.7			1.7	1.2	W.	W by N : W.	8.5
				889	44.9	43.1	1.8			1.4	0.4	W by N.		6.5
				922	44.3	40.9	3.4			1.6	0.3	W by N ?		2.5
				953	42.2	40.0	2.2			0.6	0.0		W.	0.5
				30.001	39.3	36.4	2.9			0.8	0.1	WSW ?	WNW.	3.5
				013	39.6	37.0	2.6			0.3	0.3	WSW.		1.0
				052	38.0	36.3	1.7	53.2		0.3	0.1		NW by W.	2.0
Dec. 16	0	0	0	067	42.0	38.5	3.5	32.8	0.000	0.7	0.4	WSW ½ S.	WNW ?	1.0
				088	42.6	39.0	3.6			0.8	0.2	W by S ?	NW ?	1.5
				101	39.5	37.5	2.0			0.3	0.1	WSW ?	NW.	1.5
				107	37.9	36.7	1.2			0.2	0.0			0.5
				103	40.3	38.7	1.6			0.1	0.0			10.0
				079	42.9	41.4	1.5			0.2	0.0			10.0
Dec. 17	0	0	0	42.8		3.1		W.		
								36.6						
				30.166	44.7	44.0	0.7			1.1	0.0			10.0
				171	45.3	44.6	0.7			0.1	0.0		W.	10.0
				194	44.9	44.3	0.6	51.1		0.0	0.0		WSW ? : W.	8.0
Dec. 18	0	0	0	196	47.3	45.8	1.5	37.2	0.000	0.1	0.1	SW ?	WSW ?	9.9
				194	47.3	45.4	1.9			0.1	0.0		WSW.	9.9
				191	45.3	43.6	1.7			0.3	0.1	SW ½ S.	WSW.	9.9
				192	42.9	41.7	1.2			0.1	0.0		WSW.	8.8
				200	43.6	42.5	1.1			0.0	0.0			10.0
				205	42.9	41.8	1.1			0.0	0.0			9.8
				30.161	42.8	41.5	1.3			0.3	0.0			10.0
				150	42.7	41.1	1.6			0.1	0.0			10.0
				146	42.7	41.2	1.5	47.2		0.0	0.0		SW.	10.0
Dec. 19	0	0	0	146	44.7	41.8	2.9	41.6	0.008	0.0	0.0		SW.	10.0
				119	44.3	41.7	2.6			0.2	0.1	SW by S.		10.0
				113	44.0	41.7	2.3			0.3	0.1	SSW ?	WSW ½ S.	10.0
				111	43.8	41.9	1.9			0.2	0.0			10.0

Dec. 14^d 22^h. The minimum temperature is taken from the readings of the dry bulb thermometer.

SPECIES OF CLOUDS, &c.

Observer's
Initial.

h.		
20.	Scud.	W
22.	Id., in loose masses.	B
0.	Id., id.	W
2.	Id., id. : woolly and mottled cirri, moving very slowly.	W
4.	Id. + cirrous clouds.	W
6.	Id.	W
8.	Id.	W
10.	Id. ; very dark.	B
18.	Scud + thin cirrous clouds to S.	W
20.	Patches of loose scud + linear cirri and cirrous haze ; very thin cirro-strati on horizon.	W
22.	Thin low scud + thick cirrous haze, mottled cirri, and cirro-strati, covering the sky ; the mottled cirri, radiating in sheets from SSE $\frac{1}{2}$ E.	B
0.	Scud : cirrous clouds ; nearly as before.	B
2.	As at 0 ^h ; clouds quite blue to SE., sky to WNW.	B
4.	Scud + mottled, waved, and reticulated cirri ; cirrous haze.	W
6.	Id. + thin cirrous clouds and cirrous haze.	W
8.	Id. ; slight drops of rain.	B
10.	Id.	B
18.	Id.	W
20.	Id. ; a few drops of rain.	W
22.	Thin scud : woolly woven cirri, radiating from E. and W. ; light rain.	B
0.	Id. + cirri ; light rain.	B
2.	Id. + id. ; drops of rain.	B
4.	Id. : mottled and interlaced cirri.	W
6.	Scud.	W
8.	Id., radiating from W. and E.	B
10.	Patches of scud.	B
18.	Scud + bands of light cirri lying E. and W.	W
20.	Cirro-strati and linear cirri ; masses of scud to S.	W
22.	Flambeaux of woolly cirri reaching from E. horizon to zenith, radiating from about ENE. ; linear cirri to S. lying ESE. to WNW.	B
0.	Strips of mottled cirri + cirro-strati and cirrous haze on horizon.	B
2.	Cirro-strati, sheets of reticulated, mottled, and curled cirri.	B
4.	Thin woolly cirri and masses of cirro-cumuli + cirro-strati and cirrous haze on horizon ; masses of scud.	W
6.	Cirro-strati.	W
8.	Dark.	B
10.	Id.	B
18.	Id.	B
20.	Scud.	B
22.	Patches of loose scud : large, loose, woolly cirro-cumuli + woolly cirri.	W
0.	Thick cirro-cumulo-strati + masses of loose scud to S.	W
2.	Scud + cirro-strati to E.	W
4.	Id. + id.	W
6.	Id.	B
8.	Id.	W
10.	Id.	W
18.	Dark.	B
20.	Thick scud.	B
22.	Id., moving slowly.	W
0.	Id.	W
2.	Id.	W
4.	Scud.	B
6.	Id.	B

Göttingen Mean Time of Observation.			BARO- METER Corrected.	THERMOMETERS.				RAIN GAUGE.	ANEMOMETER.			Clouds moving from	Quan- tity of Clouds.
				Dry.	Wet.	Diff.	Max. and Min.		Pressure.		Direction of Wind.		
									Max.	Pres.			
Dec. 19	d. h. m.		in.	°	°	°	°	in.	lbs.	lbs.			1-10.
	8 0		30-095	43.7	42.2	1.5			0.3	0.1	S by W.		10.0
	10 0		098	45.3	43.6	1.7			0.3	0.0			10.0
	18 0		30-074	46.7	45.4	1.3			0.6	0.0			10.0
	20 0		30-048	45.7	44.1	1.6	46.4		0.1	0.1	SSW ?	SW.	9.9
	22 0		30-036	45.7	43.9	1.8	41.4		0.3	0.1	SSW ½ W.	WSW.	9.8
Dec. 20	0 0		30-010	46.6	44.6	2.0		0.002	0.2	0.2	SSW ½ W.	SW : SW ?	10.0
	2 0		29.973	47.5	45.8	1.7			0.2	0.0		SW : WSW ?	9.8
	4 0		29.956	49.4	48.3	1.1			0.5	0.1		SW ½ W : WSW.	9.8
	6 0		29.941	49.2	47.0	2.2			1.1	0.2	SW.		10.0
	8 0		29.913	48.5	46.0	2.5			1.1	0.6	SW.		6.5
	10 0		29.891	47.7	45.6	2.1			0.5	0.2	SW.		10.0
	18 0		29.940	45.5	44.5	1.0			0.0	0.0			7.0
	20 0		29.994	39.0	39.0	0.0	49.0		0.0	0.0		W.	0.3
	22 0		30-055	38.9	38.7	0.2	38.4		0.1	0.0	SW.	WNW ?	0.3
Dec. 21	0 0		30-077	43.4	42.3	1.1		0.040	0.1	0.1	SSW.	WNW.	5.0
	2 0		30-086	45.0	43.6	1.4			0.2	0.0			0.5
	4 0		30-103	40.8	40.6	0.2			0.0	0.0			1.5
	6 0		30-109	37.1	37.0	0.1			0.0	0.0			2.0
	8 0		30-105	39.6	39.3	0.3			0.0	0.0			3.0
	10 0		30-067	38.6	38.0	0.6			0.0	0.0			0.5
	18 0		29.925	44.2	43.7	0.5			0.3	0.0		WSW ?	3.0
	20 0		871	45.3	44.1	1.2	46.1				7.0 ?
	22 0		826	48.3	46.2	2.1	36.2		SSW.		
Dec. 22	0 0		759	51.0	48.6	2.4		0.000	2.8	1.4	SSW.	SSW.	10.0
	2 0		691	53.0	51.0	2.0			4.5	3.4	SW by S.	SW by S.	10.0
	4 0		636	53.7	51.8	1.9			6.0	4.8	SSW ½ W.	SW ½ W.	7.0
	6 0		631	53.7	50.5	3.2			7.3	5.6	SSW ½ W.	SW ?	7.0
	8 0		660	52.2	48.2	4.0			5.8	3.9	SW by S.		7.5
	10 0		710	51.0	46.8	4.2			4.7	2.1	SW by S.		10.0
	18 0		29.887	50.0	46.8	3.2			5.2	2.1	SW by S.	WSW.	6.0
	20 0		937	48.5	45.2	3.3	53.9		1.9	1.1	SW by S.	W by S.	7.0
	22 0		964	46.8	45.6	1.2	46.3		2.5	1.3	SW ½ S.	SW by W : W : W by N.	6.0
Dec. 23	0 0		996	49.0	46.9	2.1		0.000	3.5	1.7	SW.	SW by W : W.	7.5
	2 0		984	50.7	48.6	2.1			1.7	0.4	SW.	SW : W.	9.0
	4 0		961	50.2	48.2	2.0			0.7	0.2	SW ?	SW by W.	8.5
	6 0		984	51.0	49.7	1.3			0.6	0.5	WSW.		8.0
	8 0		969	51.9	50.9	1.0			2.1	0.6	SW.		10.0
	10 0		965	52.0	51.2	0.8			3.5	1.4	SW ½ W.		10.0
Dec. 24	0 0		52.0 49.8		3.4	...	SW.		
	18 0		30-186	49.6	49.0	0.6			1.1	0.0			10.0
	20 0		184	50.6	49.7	0.9	54.6		0.0	0.0		SSW.	9.8
	22 0		179	51.3	50.3	1.0	44.9		0.3	0.2	SSW.	SW by S.	10.0
Dec. 25	0 0		166	51.1	50.2	0.9		0.010	0.5	0.5	SSW.	SSW ½ W.	10.0
	2 0		132	51.8	50.0	1.8			0.2	0.1	SSW.	SW ½ S.	10.0
	4 0		095	50.2	48.0	2.2			1.5	0.2	S by W.	SW : SSW ½ W.	9.5
	6 0		079	48.0	45.7	2.3			2.2	1.6	WSW ½ S.		2.0
	8 0		074	48.1	45.8	2.3			1.4	1.3	SW ½ W.	SW.	6.0
	10 0		085	48.7	46.3	2.4			1.4	0.1	SSW ?		8.0
	18 0		30-078	47.6	45.4	2.2			3.0	1.1	SW by S.		4.5
	20 0		095	46.9	45.1	1.8	51.4		1.6	0.3	SW ½ W.	SW by W.	7.0
	22 0		130	47.8	46.2	1.6	45.4		0.6	0.1		SW : W by S.	9.0

Dec. 20^d 22^h. The maximum and minimum are taken from the dry bulb thermometer.
 Dec. 21^d 20^h and 22^h. The meteorological observations are interpolated for the purposes of summation from the observations at 19^h, 21^h, and 23^h (see *Extra Observations*), the observations at 20^h and 22^h being accidentally lost.

SPECIES OF CLOUDS, &c.

	Observer's Initial.
8. Scud.	W
10. Id.	W
18. Thick clouds.	B
20. Scud + cirro-strati to SE., with a patch of reddish sky.	B
22. Loose scud + dense homogeneous cirrous mass; cirro-strati on E. horizon	W
0. Scud: cirrous mass.	W
2. Loose scud: cirro-cumuli and dense cirrous clouds.	W
4. Id.: id.	B
6. Scud.	W
8. Id.	W
10. Id.	W
18. Strata of clouds lying ENE. to WSW.	B
20. Scud to S. + cirro-strati on E. horizon.	B
22. Patches of scud + cirro-strati and cirrous haze to SE.	W
0. Woolly and linear cirri.	H
2. Patches of mottled and woolly cirri; cirrous haze and cirro-strati on horizon.	W
4. Cirro-cumuli and woolly cirri to NW.; cirrous haze on horizon.	W
6. Sheets of cirro-strati reaching from SSW. to E.	B
8. Clouds on E. and S. horizon.	H
10. Streaks of clouds.	W
18. Scud + cirro-strati and cirrous haze to E.	B
20. Scud and cirrous clouds.	B
22.	
0. Scud.	W
2. Id.	W
4. Id.; clouds just clearing off.	B
6. Id.	B
8. Id.	W
10. Id.	W
18. Id.	B
20. Id.	B
22. Two currents of scud: woolly and linear cirri and loose cirro-cumuli.	W
0. Scud: cirro-cumuli.	W
2. Scud: two strata of cirro-cumuli + cirro-strati to SE., having the appearance of an oblique section of thin layers of sandstone, slightly contorted.	W
4. Scud + sheets of cirro-strati, cirro-cumuli, and cirri, in different strata. About 4 ^h 20 ^m the cirro-strati to [E. were very red.	B
6. Principally cirro-strati.	W
8. Overcast.	W
10. Id.	W
18. Id.	W
20. Scud.	W
22. Id.	B
0. Id.; the slightest spit of rain.	B
2. Id.	B
4. Id., in two currents.	W
6. Id.	W
8. Id.	W
10. Id.	B
18. Id.	W
20. Id. + woolly cirri, slightly tinged with red.	W
22. Id.: cirri.	B

Göttingen Mean Time of Observation.			BARO- METER Corrected.	THERMOMETERS.				RAIN GAUGE.	ANEMOMETER.			Clouds moving from	Quantity of Clouds.
				Dry.	Wet.	Diff.	Max. and Min.		Pressure.		Direction of Wind.		
									Max.	Pres.			
Dec. 26	d. h. m.	in.	°	°	°	°	in.	lbs.	lbs.			0-10.	
	0 0	30.137	49.6	47.3	2.3		0.000	0.3	0.3	SW ½ S.	SW : W by S.	9.5	
	2 0	115	49.6	47.2	2.4			0.9	0.4	SW ½ W.	SW.	10.0	
	4 0	101	48.3	46.1	2.2			0.4	0.2	SW.	SW by W.	9.0	
	6 0	104	45.6	44.3	1.3			0.6	0.3	SW.		1.0	
	8 0	101	42.1	42.0	0.1			0.2	0.0			8.5	
	10 0	101	44.8	44.3	0.5			0.1	0.0			9.5	
	18 0	30.072	45.0	43.9	1.1			0.3	0.3	SW by S.		9.0	
	20 0	079	44.3	43.6	0.7			0.5	0.4	SW ½ S.		1.0	
	22 0	106	46.3	45.3	1.0	50.7		0.8	0.1	SW by S.	W ½ N.	8.0	
Dec. 27	0 0	127	48.0	46.1	1.9	39.2	0.000	0.5	0.1	SW ½ S.	W ½ N.	9.5	
	2 0	112	48.8	46.3	2.5			0.2	0.1	SW ½ S.	W	9.8	
	4 0	113	45.0	43.9	1.1			0.2	0.1	SW.	WSW ½ W.	6.0	
	6 0	141	42.7	41.8	0.9			0.8	0.2	SW ½ S.		0.8	
	8 0	159	40.7	40.1	0.6			0.3	0.1	SW ?	W	0.3	
	10 0	185	41.0	40.2	0.8			0.2	0.0			0.5	
	18 0	30.182	42.3	42.2	0.1			0.3	0.1	SSW ?		0.2	
	20 0	185	42.5	42.0	0.5	48.8		0.2	0.0		WSW.	2.0	
	22 0	205	44.7	44.6	0.1	38.5		0.0	0.0		SW ½ W.	8.0	
Dec. 28	0 0	207	46.9	46.0	0.9		0.000	0.3	0.2	SW ½ S.	SW by W.	2.0	
	2 0	181	48.2	45.9	2.3			1.8	1.8	SW.	SW by W.	7.0	
	4 0	189	46.7	44.9	1.8			1.6	0.3	S by W.	WSW ½ S.	9.8	
	6 0	160	46.0	44.3	1.7			0.8	0.6	SSW.	WSW ½ S.	10.0	
	8 0	168	46.0	43.8	2.2			0.7	0.3	SW ½ S.		10.0	
	10 0	159	46.0	43.0	3.0			0.4	0.3	SW ½ S.	WSW ½ W.	10.0	
	18 0	30.103	45.7	42.9	2.8			1.3	0.2	SW ½ S.		10.0	
	20 0	084	45.6	43.2	2.4			1.5	0.3	SW ½ S.	WSW.	10.0	
	22 0	095	46.1	43.8	2.3	49.0		0.9	0.3	SW.	WSW ½ S.	10.0	
Dec. 29	0 0	092	47.7	45.0	2.7	44.5	0.000	0.5	0.4	SW.	WSW.	7.0	
	2 0	051	47.9	45.2	2.7			0.5	0.3	SW ½ S.	SW by W : W.	1.0	
	4 0	039	47.0	44.9	2.1			1.0	0.3	SW by S.	W by S : W ½ N.	3.5	
	6 0	029	46.9	44.9	2.0			1.7	0.2	SSW ½ W.		8.0	
	8 0	011	46.1	45.0	1.1			0.3	0.1	SW by S.	WSW ½ W.	8.5	
	10 0	003	47.7	45.7	2.0			1.1	0.1	SW by S.		10.0	
	18 0	29.844	44.5	42.4	2.1			2.7	0.2	SW.		2.0	
	20 0	839	45.9	43.5	2.4	47.5		1.7	0.7	SW by S.	WSW : W.	2.5	
	22 0	818	46.0	43.6	2.4	43.5		3.4	2.1	SW ½ S.	WSW : W.	4.5	
Dec. 30	0 0	812	47.9	43.1	4.8		0.000	2.1	0.8	SW ½ S.	SW by W : WSW : SW by W ?	2.8	
	2 0	758	45.8	42.7	3.1			3.7	3.0	SW ½ S.	SW by W : WSW : SW by W ?	2.5	
	4 0	732	44.0	41.7	2.3			2.3	0.2	SW by S.	WSW : WSW ?	1.8	
	6 0	696	43.4	41.3	3.1			1.7	0.6	SSW ½ W.	WSW.	3.0	
	8 0	644	44.9	42.7	2.2			2.5	1.1	SW by S.	WSW.	2.3	
	10 0	618	45.2	42.9	2.3			2.1	1.1	SW by S.	WSW.	8.5	
Dec. 31	0 0	46.6	0.148	4.2					
						41.6							
						47.7							
	23 0	26.7	0.238						

SPECIES OF CLOUDS, &c.	Observer's Initial.
h.	
0. Cirrous scud : woolly cirri +- cirro-strati.	B
2. Scud.	W
4. Id.	W
6. Masses of scud to N. ; lines of cirro-cumuli to S. lying WSW. to ENE. ; thin cirri causing a corona about [the Moon.	W
8. Scud.	B
10. Id.	B
18. Scud ; a few minutes ago the quantity of clouds was 6.	W
20. Masses of scud near horizon ; cirrous haze to E.	W
22. Scud.	B
0. Id.	W
2. Id.	B
4. Id.	W
6. Masses of scud.	W
8. Patches of scud.	B
10. Id.	B
18. Streaks of clouds on N. and S. horizon.	W
20. Masses of scud +- cirro-strati and cirrous haze on horizon.	W
22. Cirro-cumuluous scud or large cirro-cumuli with loose edges +- cirro-strati with haze to E. ; uncommonly heavy dew, hanging in large drops on the palings, &c.	B
0. Loose cirro-cumuluous scud +- masses of loose cumuli to S. and E. ; cirro-strati to E.	W
2. Id. +- thin scud below.	B
4. Very loose scud +- patches of cirro-strati to N.	W
6. Scud.	W
8. Id.	W
10. Id.	W
18. Id.	W
20. Id.	W
22. Id.	B
0. Cirro-cumuluous scud +- thin scud to SE.	B
2. Thin scud : watery woolly cirri.	B
4. Loose scud : cirrous scud +- patches of cirro-strati to E.	W
6. Scud.	W
8. Id.	B
10. Id.	B
18. Masses of loose scud.	W
20. Dark scud to S. : masses of loose woolly cirrous scud.	W
22. Id. : id. +- between the scud and cirri are cirro-strati in strata one above another, and with cirrous and cirro-cumuluous edges.	B
0. Scud : loose and other cirro-strati : mottled and linear cirri.	H
2. Id. : id. ; id.	B
4. Id. : id.	H
6. Id. +- linear cirri and cirro-strati ; the Moon seen distinctly through the scud. [strati to N.	W
8. Masses of loose scud +- bands of linear cirri and cirrous haze reaching across the sky, lying SW. to NE. ; cirro-	B
10. Cirro-cumuluous scud +- sheets of cirri.	B



TERM-DAY
AND
EXTRA METEOROLOGICAL
OBSERVATIONS.

MAKERSTOUN OBSERVATORY,
1843.

TERM-DAY AND EXTRA METEOROLOGICAL

Göttingen Mean Time of Observation.			BAROMETER Corrected.	THERMOMETERS.			ANEMOMETER.		Clouds moving from	Quantity of Clouds.		
				Dry.	Wet.	Diff.	Pressure.				Direction of Wind.	
							Max.	Pres.				
d.	h.	m.	in.	°	°	°	lbs.	lbs.		0-10.		
Jan.	9	20	47	28.221							0-10.	
Jan.	12	20	0	28.029	33.9	33.8	0.1	...	0.3	SE.	10.0	
		20	52	27.978								
		21	0	971								
		22	0	909	34.3	33.3	1.0	3.5	3.0	SE by S.	10.0	
		23	0	885								
		23	35	870								
Jan.	13	0	0	864	35.6	34.7	0.9	3.2	0.5	SE.	SSE ?	9.7
		0	35	849								
		2	5	837	37.6	35.3	2.3	0.0	0.0			10.0
		4	0	850	35.6	34.7	0.9	0.0	0.0			10.0
Jan.	18	10	0	30.126	46.2	45.4	0.8	0.5	0.0			10.0
		11	0	127	46.2	45.0	1.2	0.3	0.3	WSW.		10.0
		12	0	130	46.3	45.4	0.9	0.5	0.5	W.		9.5
		13	0	133	46.2	45.5	0.7	0.5	0.5	W.		9.7
		14	0	139	46.1	45.3	0.8	0.5	0.7	W.		10.0
		15	0	150	46.8	45.7	1.1	0.8	0.5	SW by W.	WSW.	10.0
		16	0	153	46.9	45.4	1.5	1.0	0.0	W.		10.0
		17	0	132	46.0	45.2	0.8	1.2	2.0	SW by W.	W.	5.0
		18	0	139	46.2	45.2	1.0	1.8	1.0	WSW.	WSW.	6.0
		19	0	147	46.0	44.8	1.2	1.5	0.5	SW by W.	WSW.	9.0
		20	0	174	45.6	44.2	1.4	1.8	0.5	WSW.		10.0
		21	0	179	45.5	44.0	1.5	0.3	0.0			10.0
		22	0	190	45.8	44.8	1.0	0.5	0.5	SW by W.		10.0
		23	0	203	46.1	45.2	0.9	0.5	0.0			10.0
Jan.	19	0	0	196	46.8	45.7	1.1	0.5	0.8	SW by W.	WSW ?	10.0
		1	0	182	47.0	45.9	1.1	1.0	0.5	SW by W.		10.0
		2	0	176	47.0	45.5	1.5	0.0	0.0			10.0
		3	0	172	46.3	45.2	1.1	1.0	0.0			10.0
		4	0	172	46.5	45.2	1.3	0.0	0.0			10.0
		5	0	180	46.2	45.2	1.0	0.5	0.0			10.0
		6	0	182	45.3	44.4	0.9	0.3	0.3	SW.		10.0
		7	0	182	45.0	44.0	1.0	0.5	0.3	SW by W.		10.0
		8	0	184	44.7	43.7	1.0	0.3	0.0			10.0
		9	0	172	44.0	43.0	1.0	0.5	0.5	SW by W.		9.0
		10	0	176	43.5	42.5	1.0	1.0	1.0	SW by S.		9.0
Feb.	24	10	0	29.586	35.6	34.7	0.9	0.0	0.0			10.0
		11	0	583	35.2	34.6	0.6	0.0	0.0			10.0
		12	0	579	35.3	34.6	0.7	0.0	0.0			10.0
		13	0	580	34.8	34.3	0.5	0.0	0.0			9.0
		14	0	586	34.8	34.2	0.6	0.0	0.0			9.0
		15	0	582	34.9	34.4	0.5	0.0	0.0			9.0
		16	0	575	34.7	34.3	0.4	0.0	0.0			10.0
		17	0	584	34.5	33.9	0.6	0.0	0.0			10.0
		18	0	582	34.7	33.8	0.9	0.0	0.0			10.0
		19	0	590	34.5	33.5	1.0	0.0	0.0			8.0
		20	0	596	33.0	33.4	0.6	0.0	0.0		SSE : N.	9.0
		21	0	586	34.6	33.9	0.7	0.0	0.0		E by N.	10.0
		22	0	590	35.5	34.0	1.5	0.0	0.0			10.0
		23	0	586	36.5	34.2	2.3	0.0	0.0			10.0
Feb.	25	0	0	579	36.6	34.3	2.3	0.0	0.0		E.	10.0
		1	0	568	37.5	34.8	2.7	0.0	0.0			10.0
		2	0	559	37.6	35.4	2.2	0.0	0.0			10.0

SPECIES OF CLOUDS, &c.		Observer's Initial.
h. m.		
20 47.		
20 0.	Snowing.	B
20 52.		
21 0.		
22 0.	Sleet.	W
23 0.		
23 35.		
0 0.	Scud +- thick cirrous clouds; very hazy to E.; sky in patches to SW.	W
0 35.		
2 5.	Homogeneous, except a few cumuli to S.	W
4 0.		W
10 0.	Light rain.	D
11 0.	Very light rain.	D
12 0.	Scud and cirri.	D
13 0.	Scud; cirrous clouds.	D
14 0.	Id.; id.	W
15 0.	Scud, moving rapidly.	W
16 0.	Id. +- cumulo-strati on horizon.	W
17 0.	Id. +- woolly cirri.	W
18 0.	Id., moving rapidly.	D
19 0.	Id.	D
20 0.	Homogeneous scud; light rain.	D
21 0.	Scud.	D
22 0.	Id.; cumulo-strati on NE. horizon.	W
23 0.	Homogeneous scud; clearer to NE?	B
0 0.	Scud, nearly homogeneous.	B
1 0.	Homogeneous scud.	B
2 0.	Id. 2 ^h 30 ^m . The wind blew a gust of 1 lb. from WSW.	H
3 0.	Id.	H
4 0.	Id.	B
5 0.	Id.	B
6 0.	Light rain.	H
7 0.	Dark.	B
8 0.	Id.	W
9 0.	Apparently haze over a portion of the sky, as the stars are but dimly seen.	B
10 0.	As at last hour.	B
10 0.	Scud. A lightish appearance to N.; Aurora?	W
11 0.	Id.	W
12 0.	Id.	W
13 0.	Id.; a lightish appearance to NE.; Aurora?	W
14 0.	Patches of scud; dark clouds to NW.	H
15 0.	Id.; id.	H
16 0.	Lightish streak on SE. horizon.	H
17 0.		H
18 0.	Scud; a light streak on NE. horizon.	W
19 0.	Cirrous clouds to E.; clear on E. horizon.	H
20 0.	Cirrous scud: woolly cirri +- patches of cirro-cumuli; heavy clouds to E.	H
21 0.	Id.	W
22 0.	Id.	H
23 0.	Clearing to S.	H
0 0.	Cirrous scud +- patches of loose scud below.	W
1 0.	Id.	H
2 0.	Scud, thick to NE.	H

TERM-DAY AND EXTRA METEOROLOGICAL

Göttingen Mean Time of Observation.			BAROMETER Corrected.	THERMOMETERS.			ANEMOMETER.		Clouds moving from	Quantity of Clouds.	
				Dry.	Wet.	Diff.	Pressure.				Direction of Wind.
							Max.	Pres.			
Feb.	d.	h. m.	in.	°	°	°	lbs.	lbs.		0-10.	
	25	3 0	29.554	37.3	34.6	2.7	0.3	...		10.0	
		4 0	547	35.3	34.5	0.8	0.3	0.0	ENE?	10.0	
		5 0	548	36.0	34.8	1.2	0.0	0.0	E.	10.0	
		6 0	547	35.3	34.1	1.2	0.0	0.0	E.	10.0	
		7 0	563	34.8	33.8	1.0	0.0	0.0		10.0	
		8 0	571	34.4	33.4	1.0	0.0	0.0		10.0	
		9 0	566	34.6	33.6	1.0	0.0	0.0		10.0	
		10 0	551	33.3	32.8	0.5	0.0	0.0		10.0	
Mar.	6	14 0	29.975	38.0	37.6	0.4		2.0	
		16 0	974	37.2	36.9	0.3			
Mar.	12	13 0	29.250	41.2	38.2	3.0	2.5	1.5	W.	2.0	
		14 0	252	41.1	38.1	3.0	2.5	1.5	W.	2.0	
Mar.	20	18 0	29.212	41.8	41.4	0.4	0.5	0.0		10.0	
		19 0	206	42.9	42.0	0.9	0.3	0.0	E.	10.0	
		20 0	200	43.8	43.0	0.8	0.0	0.0	SSE.	10.0	
		21 0	192	45.2	44.6	0.6	0.3	0.0	ESE.	10.0	
		22 0	197	49.8	49.1	0.7	0.5	0.3	SE by S.	9.8	
		23 0	187	50.6	48.1	2.5	1.8	1.0	S.	SSE : SSE?	
Mar.	21	0 0	189	52.4	49.7	2.7	1.5	1.0	S by E.	S.	
		1 0	187	53.8	50.3	3.5	1.2	0.5	SSE.	SSE : S.	
		2 0	184	54.1	49.2	4.9	1.8	0.8	SSE.	S.	
		3 0	182	55.6	50.2	5.4	1.5	0.8	S by E.	S.	
		4 0	182	54.2	50.0	4.2	0.5	0.3	SE by S.	S.	
		5 0	179	54.9	50.7	4.2	0.8	0.5	SE.	9.0	
		6 0	218	49.3	46.3	3.0	1.0	0.3	SW by S?	Varying.	
		7 0	216	48.0	46.0	2.0	0.0	0.0		SE by S.	
		8 0	228	45.5	44.5	1.0	0.5	0.0		SSW.	
		9 0	212	44.2	43.3	0.9	0.4	0.0		1.0	
		10 0	200	43.0	42.7	0.3	0.3	0.0		0.0	
		11 0	198	44.8	44.2	0.6	0.0	0.0		0.1	
		12 0	187	45.3	44.1	1.2	0.3	0.0		0.3	
		13 0	187	46.0	45.0	1.0	0.3	0.3	SE.	8.0	
		14 0	181	47.7	45.9	1.8	0.5	0.3	E by N.	6.0	
		15 0	156	46.0	44.6	1.4	0.3	0.0		7.0	
		16 0	148	44.7	43.6	1.1	0.3	0.0		10.0	
		17 0	132	45.3	44.1	1.2	0.3	0.0		10.0	
		18 0	127	47.7	45.7	2.0	0.0	0.0		S by W?	
		19 0	113	47.3	45.5	1.8	0.3	0.0		SSE.	
		20 0	122	47.5	46.0	1.5	0.3	0.3	S by E.	SSE.	
		22 0	136	48.0	47.0	1.0	0.8	0.3	S by E.	10.0	
		23 0	117	49.0	47.8	1.2	0.5	0.0	S.	9.9	
Mar.	22	0 0	117	53.7	50.6	3.1	1.3	1.3	S by E.	SSE.	
		2 0	127	58.0	52.4	5.6	2.5	1.5	S by W.	S by W.	
		3 0	134	58.8	51.0	7.8	2.0	2.7	S by W.	7.0	
		4 0	134	59.2	51.8	7.4	1.3	0.8	S by W.	SSW.	
		5 0	166	56.7	50.2	6.5	1.2	0.5	S by W.	S by W.	
		6 0	175	54.0	48.8	5.2	0.3	0.3	S by W.	SSW.	
		7 0	207	50.0	47.0	3.0	0.3	0.0		S.	
		8 0	219	47.7	45.6	2.1	0.0	0.0		S.	
		9 0	227	49.6	47.0	2.6	0.0	0.0		3.0	
		10 0	239	46.2	44.7	1.5	0.0	0.0		8.0	

SPECIES OF CLOUDS, &c.

Observer's
Initial.

h.	m.		
3	0.	Scud ; rain to ENE ?	B
4	0.	Cirrous scud ; hail a short time ago.	W
5	0.	Scud + cirrous scud.	W
6	0.	Loose scud + cirrous clouds.	W
7	0.	Id. + id.	B
8	0.	Very dark.	D
9	0.	Id.	D
10	0.	Id.	D
14	0.	Cumulous scud to NW. Light seen through the clouds to NNW., and when the clouds clear away a bank of light is seen along that portion	B
16	0.	[of the horizon.]	B
13	0.	Scud. Faint auroral light, stronger four hours ago.	B
14	0.	Id.	B
18	0.	Scud ; light rain.	B
19	0.	Loose thin scud.	B
20	0.	Scud.	B
21	0.	Id. + loose-edged cumulo-strati and loose cumuli to E. and SE.	
22	0.	Id. + woolly cirro-cumuli and fine linear cirri lying N. and S. ; cumulo-strati and loose cumuli near	W
23	0.	Large detached masses of scud : cirro-cumuli. [the horizon.]	W
0	0.	Scud and loose cumuli + woolly cirri and cirro-cumuli.	W
1	0.	Thin scud : cirrous clouds.	W
2	0.	Detached masses of cumuli + cirro-cumuli.	W
3	0.	Loose cumuli + woolly cirri.	W
4	0.	Scud and masses of woolly cirro-cumuli.	B
5	0.	Scud ; very dark to SSW. ; thunder ?	B
6	0.	A large mass of electric clouds moved up from SSW. ; at first the W. was covered, but the tendency of the whole is towards the E. ; the clouds at first appeared to be acted on by several currents, now they appear to move from SSE. ; large drops of rain ; sky to E. with beautiful cumulo-strati to SSE.	B
7	0.	Thick scud, falling in showers, the drops very large ; hazy to E. ; very black to S. and W.	B
8	0.	Heavy showers, scud.	B
9	0.	Clear, except a few clouds to N.	W
10	0.	Clear.	W
11	0.	Id., except a small patch of scud to E.	W
12	0.	Patches of loose scud.	W
13	0.	Thin scud.	W
14	0.	Id.	W
15	0.	Id.	W
16	0.	Id.	W
17	0.	Id.	W
18	0.	Scud in different strata, moving very slowly + cumulo-strati and cirro-strati to E. ; the latter very red.	B
19	0.	Thick scud, a few drops of rain ; cirrous clouds or haze above ?	B
20	0.	Scud ; light rain.	B
22	0.	Raining.	W
23	0.	Thick scud ; clearing up from SSW. ; rain.	W
0	0.	Patches of cirrous scud + a mass of clouds covers the sky from NW., by E., to SE. to an altitude of 40°, curled cirri at the edges, apparently becoming haze to NE. ; cumulo-strati near horizon ; cumuli to SW.	W
2	0.	Detached masses of loose cumuli + the sky almost completely covered with thin crossed woolly cirri ;	W
3	0.	As at 2 ^h . [cirrous haze on E. horizon.]	W
4	0.	Masses of loose cumuli and cumulo-strati + woolly cirrous clouds.	B
5	0.	Masses of cirrous-edged cumuli + ranges of cumuli on E. and S. horizon ; thin mixed woolly cirri.	B
6	0.	Large masses of cumulo-strati + cirrous clouds.	B
7	0.	Masses of scud ; the sky quite milky with cirrous haze.	W
8	0.	Thick masses of scud.	W
9	0.	Scud.	W
10	0.	Id.	H

TERM-DAY AND EXTRA METEOROLOGICAL

Göttingen Mean Time of Observation.			BAROMETER Corrected.	THERMOMETERS.			ANEMOMETER.		Clouds moving from	Quantity of Clouds.	
				Dry.	Wet.	Diff.	Pressure.				Direction of Wind.
							Max.	Pres.			
d.	h.	m.	in.	°	°	°	lbs.	lbs.		0-10.	
Mar.	22	11 0	29.234	47.0	44.8	2.2	0.0	0.0		10.0	
		12 0	227	47.9	45.4	2.5	0.0	0.0		10.0	
		13 0	222	47.6	46.2	1.4	0.0	0.0		10.0	
		14 0	216	48.3	46.6	1.7	0.0	0.0		9.0	
		15 0	192	48.2	46.5	1.7	0.5	0.3	SE.	S by E.	7.0
		16 0	177	47.9	46.4	1.5	0.3	0.0	NNE.		10.0
		17 0	161	47.1	45.8	1.3	0.3	1.3	SE.	SSE?	10.0
		18 0	143	48.8	46.8	2.0	2.0	0.3		ESE.	10.0
		19 0	140	50.0	47.0	3.0	1.5	0.8	E by S.	SSE.	10.0
		20 0	170	48.9	47.0	1.9	0.3	0.7		SE.	9.5
		21 0	160	47.5	45.9	1.6	0.0	0.0			10.0
		22 0	158	45.8	42.2	3.6	0.3	0.0	NNE.	SSE?	10.0
		23 0	183	47.2	47.0	0.2	0.0	0.0			10.0
Mar.	23	0 0	183	48.2	48.0	0.2	0.0	0.0		SSE.	10.0
		1 0	195	51.7	50.2	1.5	0.0	0.0		S by E.	9.7
		2 0	204	55.4	52.0	3.4	0.5	0.7		S.	7.0
		3 0	221	54.8	51.3	3.5	1.0	0.5	SE by S.	S by E.	9.9
		4 0	236	53.7	51.0	2.7	1.3	0.7	SSE.	S by E.	10.0
		5 0	269	52.7	49.3	3.4	1.3	0.3	SW.	SW.	10.0
		6 0	311	51.2	48.7	2.5	0.5	0.0			6.0
		7 0	361	48.2	46.1	2.1	0.3	0.3	SW.	SW.	6.5
		8 0	374	44.7	43.2	1.5	0.3	0.0			0.5
		9 0	406	41.0	40.8	0.2	0.0	0.0			0.2
		10 0	421	41.2	40.8	0.4	0.0	0.0			5.0
Mar.	29	12 0	29.761	32.0	31.8	0.2	0.0	0.0			0.0
Apr.	5	12 0	29.590	37.9	36.7	1.2	0.0	0.0			
		14 0	576	36.0	34.8	1.2	0.0	0.0			0.0
		16 0	531	35.7	35.0	0.7	0.0	0.0			10.0
Apr.	6	12 0	29.177	44.6	43.2	1.4	0.0	0.0			6.0
		14 0	175	41.8	40.6	1.2	0.0	0.0			0.0
		16 0	167	39.8	39.0	0.8	0.5	0.0			0.3
Apr.	19	10 0	29.623	49.0	46.7	2.3	0.0	0.0			3.0
		11 0	629	47.8	46.1	1.7	0.0	0.0			3.0
		12 0	627	45.2	44.3	0.9	0.0	0.0			4.5
		13 0	609	44.6	43.9	0.7	0.0	0.0			3.0
		14 0	595	43.5	43.3	0.2	0.0	0.0			4.0
		15 0	582	42.2	41.9	0.3	0.0	0.0			1.0
		16 0	576	38.8	38.2	0.6	0.0	0.0			1.5
		17 0	567	39.0	39.0	0.0	0.0	0.0			1.5
		18 0	557	36.3	36.0	0.3	0.0	0.0		SW.	6.0
		19 0	549	40.6	40.3	0.3	0.0	0.0			4.0
		20 0	547	44.0	42.2	1.8	0.0	0.0		S?	9.5
		21 0	547	50.2	45.3	4.9	0.0	0.0			9.0
		22 0	530	53.3	47.0	6.3	0.5	0.5	ENE.		9.0
		23 0	516	53.8	47.0	6.8	0.7	0.5	E by N.	SSE.	9.0
Apr.	20	0 0	509	55.8	49.0	6.8	0.7	0.3		SE by S.	9.9
		1 0	504	55.6	0.5	0.3		SE.	9.5
		2 0	484	55.0	50.0	5.0	0.3	0.3	E by S.	SE by S.	10.0
		3 0	463	54.2	49.0	5.2	0.5	0.1	NE.	S.	9.5
		4 0	467	52.8	48.1	4.7	0.5	0.1	NE.	SW.	10.0
		5 0	466	51.8	48.0	3.8	0.5	0.1	NE.		10.0
		6 0	468	51.3	47.5	3.8	0.3	0.0		SSW.	9.7

SPECIES OF CLOUDS, &c.		Observer's Initial.
h.	m.	
11	0. Scud.	W
12	0. Id.	H
13	0. Id.	H
14	0. Id.	W
15	0. Id.	B
16	0. A few drops of rain. The wind since last hour has moved round by E. to N.	B
17	0. Scud; a few drops of rain; wind beginning to blow.	B
18	0. Id.	H
19	0. Id., some of it very low + cirrous clouds.	B
20	0. Id.	H
21	0. Id.; drops of rain.	H
22	0. Id.; smart shower.	B
23	0. Rain.	W
0	0. Scud + cumulo-strati to S.; breaking to S.	W
1	0. Id. + large cirro-cumuli and cirrous haze; cumulo-strati and cumuli on horizon; clearing to S.	W
2	0. Scud.	D
3	0. Cirrous scud.	W
4	0. Scud; light rain.	W
5	0. Id.	H
6	0. Heavy clouds on E. horizon.	H
7	0. Scud.	D
8	0. Small patches of scud; cirrous haze on horizon.	W
9	0. Id.	W
10	0. Scud.	W
12	0. Aurora before this time. (See <i>Extra Magnetical Observations</i> .)	
12	0. Aurora. (See <i>Extra Magnetical Observations</i> .)	W
14	0. Id.; patches of clouds to NNW.	B
16	0. The sky became quickly covered with scud at 15 ^h 30 ^m .	B
12	0. Scud.	W
14	0. Aurora.	W
16	0. Id.	
10	0. Scud.	W
11	0. Id.	B
12	0. Id.	D
13	0. Clouds and haze on horizon.	H
14	0. Id.; dark.	H
15	0. Linear cirri to SSE.	B
16	0. Scud?	D
17	0. A sheet of loose cirro-cumuli; thick fog.	D
18	0. Loose cirro-cumuli and woolly cirri; thick fog.	B
19	0. Loose scud; foggy.	D
20	0. Cirrous clouds, woolly cirri, &c.	B
21	0. Id., id.	H
22	0. The sky covered with cirrous clouds and haze; cumulo-strati.	W
23	0. Nearly as before; large cirro-cumuli + cumulo-strati near horizon.	W
0	0. Scud + cirrous clouds; cumulo-strati to S.; drops of rain.	W
1	0. Id. + cirro-cumuli; the horizon dark with clouds to W.	H
2	0. Id. + a thick mass of cirrous clouds; ranges of cumulo-strati to SE. and S.	W
3	0. Id. + cirrous clouds to NE.	H
4	0. Id. + cirro-strati to E.; cirri to NE.	H
5	0. Id.; dark clouds to W.	H
6	0. Id. + large cirro-cumuli.	W

TERM-DAY AND EXTRA METEOROLOGICAL

Göttingen Mean Time of Observation.			BAROMETER Corrected.	THERMOMETERS.			ANEMOMETER.		Clouds moving from	Quantity of Clouds.			
				Dry.	Wet.	Diff.	Pressure.				Direction of Wind.		
							Max.	Pres.					
d.	h.	m.	in.	°	°	°	lbs.	lbs.		0-10.			
Apr.	20	7	0	29.479	50.9	47.9	3.0	0.0	0.0	SSW. SSW ?	10.0		
		8	0	482	49.4	46.9	2.5	0.0	0.0		10.0		
		9	0	507	48.7	47.3	1.4	0.0	0.0		10.0		
		10	0	500	50.0	47.7	2.3	0.0	0.0		8.5		
May	7	14	0	29.470	41.8	41.0	0.8				
May	26	10	0	29.181	49.8	47.3	2.5	0.7	0.3	SW.	WSW.	10.0	
		11	0	181	49.1	47.0	2.1	0.5	0.2			9.9	
		12	0	179	48.2	46.9	1.3	0.2	0.0			10.0	
		13	0	172	48.4	47.1	1.3	0.0	0.0			10.0	
		14	0	161	48.4	46.4	2.0	0.2	0.0			10.0	
		15	0	148	48.2	46.2	2.0	0.2	0.0			10.0	
		16	0	139	48.2	46.3	1.9	0.2	0.1	SW by W.	W.	10.0	
		17	0	144	48.0	46.2	1.8	0.4	0.0			10.0	
		18	0	150	47.3	46.5	0.8	0.2	0.0		W.	10.0	
		19	0	151	48.7	47.0	1.7	0.4	0.0		W.	10.0	
May	20	0	151	50.0	47.6	2.4	0.4	0.3	WSW.	W.	10.0		
		21	0	150	51.0	48.2	2.8	0.2	0.0		W by S.	10.0	
		22	0	148	50.8	47.7	3.1	0.2	0.0		W.	10.0	
		23	0	147	53.0	49.1	3.9	0.4	0.3	WSW.	SW.	10.0	
	27	0	0	144	54.7	49.7	5.0	0.4	0.1	WSW.	WSW.	10.0	
		1	0	140	53.0	48.8	4.2	0.7	0.0		WSW.	10.0	
		2	0	134	53.0	49.3	3.7	0.5	0.2	SW.	WSW.	10.0	
		3	0	125	54.3	52.7	1.6	0.6	0.2	SW by W.	W by S.	10.0	
		4	0	121	54.2	53.1	1.1	0.6	0.0			10.0	
		5	0	112	53.3	50.4	2.9	0.5	0.5	SW by W.		10.0	
		6	0	108	54.2	50.1	4.1	0.5	0.2	SW by W.	W by S.	10.0	
June	7	12	0	29.136	56.2	56.0	0.2	2.5	0.7	SSE.		10.0	
	June	20	18	0	29.745	54.2	51.0	3.2	0.8	0.6	SW by S.	NW.	8.0
			19	0	733	54.8	51.8	3.0	1.3	0.6	SW.	NW.	9.0
			20	0	737	56.2	53.6	2.6	1.5	0.3	WSW.	WSW : W.	10.0
			21	0	730	57.4	54.9	2.5	0.8	0.3	SW.	W.	10.0
			22	0	727	59.1	54.2	4.9	0.7	1.4	SW by W.	W.	10.0
	June	23	0	727	60.6	55.8	4.8	1.2	1.0	WSW.	W by S.	9.8	
		21	0	0	732	60.2	54.4	5.8	1.0	0.2	WSW.	W.	9.0
			1	0	707	62.2	56.0	6.2	2.0	0.9	W by S. v.	WNW.	3.5
			2	0	717	63.1	56.7	6.4	1.0	1.0	W by S.	W.	6.0
		3	0	723	65.0	57.1	7.9	1.8	0.8	W. v.	W by N.	8.0	
		4	0	713	64.7	56.7	8.0	1.1	0.8	WSW.	W by N.	8.5	
		5	0	701	65.6	57.4	8.2	0.8	1.0	W by S.	W by N.	8.0	
		6	0	696	63.3	56.3	7.0	1.1	1.0	WNW v.		6.0	
		7	0	704	63.0	55.2	7.8	1.5	0.5	W by N.		3.0	
June	8	0	703	61.7	54.8	6.9	0.9	0.7	W v.		0.5		
		9	0	714	57.9	52.9	5.0	0.5	0.1	W.		0.2	
		10	0	741	53.4	50.2	3.2	0.2	0.0			0.4	
		11	0	757	51.5	48.8	2.7	0.0	0.0			3.0	
		12	0	761	49.1	47.0	2.1	0.0	0.0			5.0	
		13	0	771	49.6	47.4	2.2	0.0	0.0			6.5	
		14	0	777	48.1	46.2	1.9	0.0	0.0		W by N.	6.0	

SPECIES OF CLOUDS, &c.		Observer's Initial.
h.	m.	
7	0. Scud.	W
8	0. Id.	W
9	0. Id.	D
10	0. Id.	W
14	0.	B
10	0. Cirro-cumulous scud.	H
11	0. Id.	D
12	0. Scud.	D
13	0. Id.	D
14	0. Id.; luminous opening to NE. by N. portion of horizon.	B
15	0. Id.	W
16	0. Id.	W
17	0. Id.	W
18	0. Id.; cirro-strati all round; slight drizzle.	D
19	0. Id.; id.; id.	W
20	0. Id.; cirro-strati on S. and E. horizon.	W
21	0. Id.; id. to NE.	W
22	0. Id.; id.	W
23	0. Id.	H
0	0. Id.	B
1	0. Id.	B
2	0. Id.	H
3	0. Id.; a few drops of rain.	B
4	0. Id.; id.	B
5	0. Id.; rain.	B
6	0. Id. + cirrous clouds and haze to E.	D
7	0. As before; slight shower.	W
8	0. Scud	W
9	0. Light rain.	H
10	0. Id.	H
12	0. Rain.	W
18	0. Cirro-cumulo-strati and large cirro-cumuli, moving slowly + mottled cirri.	W
19	0. Id. id., and mottled cirri + cirrous haze near horizon.	W
20	0. Scud to S.: cirro-cumulo-strati.	W
21	0. Scud, moving rather quickly + dense cirrous clouds.	
22	0. Mottled, ragged, and other kinds of scud + dense cirro-cumuli and cirrous haze; electric-looking.	B
23	0. Scud + dense cirrous clouds.	
0	0. Id. + cirro-strati and linear cirri. [turned to N.	B
1	0. Large masses of cirrous scud + cumulo-strati on horizon; curled cirri to S. lying S. and N., the curl	
2	0. Scud and loose cumuli + cirri to S.	W
3	0. Id. + cumulo-strati on E. and S. horizon.	W
4	0. Id.	W
5	0. Id.	W
6	0. Id.	W
7	0. Cumuli and cumulo-strati on N. and S. horizon; fine cirri forming.	B
8	0. Cirro-strati on horizon.	B
9	0. Cumulo-strati and cirrous haze on E. and N. horizon.	B
10	0. Cirro-strati on horizon to E. and N.; red to N.	W
11	0. Cirro-cumulous scud, stationary; cirro-strati on horizon.	W
12	0. Id.	W
13	0. Id.; cirro-strati near horizon.	W
14	0. Id., moving very slowly + cirro-strati on E. and N. horizon; very thick to E.	D

TERM-DAY AND EXTRA METEOROLOGICAL

Göttingen Mean Time of Observation.			BAROMETER Corrected.	THERMOMETERS.			ANEMOMETER.		Clouds moving from	Quantity of Clouds.	
				Dry.	Wet.	Diff.	Pressure.				Direction of Wind.
							Max.	Pres.			
d.	h.	m.	in.	°	°	°	lbs.	lbs.		0—10.	
June	21	15	0	29.771	46.7	45.0	1.7	0.0	0.0		7.5
	16	0		770	47.7	46.0	1.7	0.0	0.0	W.	8.5
	17	0		785	48.7	47.0	1.7	0.0	0.0	W by N.	8.5
	18	0		792	51.3	48.1	3.2	0.0	0.0	W by N.	8.5
	19	0		811	55.4	51.2	4.2	0.0	0.0	NW.	9.0
	20	0		813	57.0	51.0	6.0	0.0	0.0		9.0
	21	0		819	58.4	51.7	6.7	0.0	0.0	NW.	8.5
	22	0		818	59.4	52.2	7.2	0.0	0.0		9.0
	23	0		816	61.6	53.9	7.7	0.0	0.0	W by N.	8.0
June	22	0	0	822	61.0	52.1	8.9	0.0	0.0	W by N.	6.0
	1	0		825	61.3	53.0	8.3	0.0	0.0	NW by N.	6.5
	2	0		819	62.7	54.0	8.7	0.1	0.0	NW.	6.0
	3	0		816	64.6	54.0	10.6	0.2	0.0	SW by S.	6.0
	4	0		815	63.7	54.7	9.0	0.2	0.3	ENE.	4.0
	5	0		807	65.6	56.6	9.0	0.1	0.0	NW.	2.0
	6	0		804	64.0	54.8	9.2	0.0	0.0		1.0
	7	0		799	62.8	54.6	8.2	0.0	0.0	NW?	0.5
	8	0		815	60.8	54.2	6.6	0.0	0.0	NNW.	1.5
	9	0		830	56.2	51.8	4.4	0.3	0.3	NNE.	0.7
	10	0		837	52.3	49.1	3.2	0.3	0.2	NE by N.	0.7
July	5	0	0	29.510	62.9	60.3	2.6				10.0
	1	0		493							
	2	0		477	66.0	62.0	4.0				10.0
	3	0		448							
	4	0		431	62.7	60.4	2.3				10.0
	5	0		415							
	6	0		389	61.1	61.0	0.1				10.0
	7	0		337							
	8	0		303	58.5	57.8	0.7				10.0
	10	0		322	57.0	56.9	0.1				10.0
	18	0		272	56.8	55.5	1.3				10.0
	20	0		284	58.9	55.6	3.3				9.8
	21	0		297							
	22	0		287	61.6	57.1	4.5				9.5
	23	0		305							
July	6	0	0	306	63.0	58.0	5.0				9.8
	1	0		308							
	2	0		337	64.8	59.0	5.8				6.0
	3	0		369							
	4	0		406	61.8	55.3	6.5				9.8

OBSERVATIONS MADE AT BERWICK-UPON-TWEED.

July	5	3	40	29.670	58.8						
		4	0	667	58.8						
		4	35	661	56.6						
		5	0	655	56.7						
		5	30	642	55.6						
		5	45	662	56.1						
		6	0	661	56.6						
		8	5	541	54.8						
		8	30	531	55.1						
		9	0	546	55.1						

July 5—6. The above observations were made at the end of the pier at Berwick for the purpose of determining the height of the barometer at Makerstoun above the level of the sea, but were rendered valueless for that purpose by the occurrence of a thunder-storm. Height of the cistern of the barometer at the Berwick pier above the mean level of the sea = 32 feet.

SPECIES OF CLOUDS, &c.		Observer's Initial.
h.	m.	
15	0.	W
	0.	W
16	0.	W
17	0.	W
18	0.	W
19	0.	H
20	0.	H
21	0.	H
22	0.	H
23	0.	H
0	0.	W
1	0.	H
2	0.	B
3	0.	W
4	0.	W
5	0.	W
6	0.	H
7	0.	B
8	0.	D
9	0.	D
10	0.	D
0	0.	W
1	0.	W
2	0.	W
3	0.	W
4	0.	W
5	0.	W
6	0.	W
7	0.	W
8	0.	W
10	0.	W
18	0.	W
20	0.	W
21	0.	W
22	0.	W
23	0.	W
0	0.	W
1	0.	W
2	0.	W
3	0.	W
4	0.	W
3	40.	B
4	0.	B
4	35.	B
5	0.	B
5	30.	B
5	45.	B
6	0.	B
8	5.	B
8	30.	B
9	0.	B

TERM-DAY AND EXTRA METEOROLOGICAL

Göttingen Mean Time of Observation.			BAROMETER Corrected.	THERMOMETERS.			ANEMOMETER.		Clouds moving from	Quantity of Clouds.		
				Dry.	Wet.	Dif.	Pressure.				Direction of Wind.	
							Max.	Pres.				
d.	h.	m.	in.	°	°	°	lbs.	lbs.		0-10.		
July	5	22	0	29.532	60.0							
		22	30	517	60.6							
		23	0	527	60.9							
		23	30	529	61.1							
July	6	0	0	531	61.3							
		0	30	524	61.6							
		1	0	525	61.7							
		1	30	526	63.3							
		2	0	526	62.7							
July	19	10	0	29.490	51.0	49.7	1.3	0.1	0.0		W.	10.0
		11	0	498	51.4	50.0	1.4	0.0	0.0			9.9
		12	0	497	50.0	49.0	1.0	0.0	0.0			9.7
		13	0	486	48.7	48.0	0.7	0.0	0.0			9.9
		14	0	479	49.8	48.7	1.1	0.0	0.0			10.0
		15	0	458	48.7	47.8	0.9	0.0	0.0			9.9
		16	0	450	46.7	45.9	0.8	0.0	0.0		W.	8.0
		17	0	444	46.0	45.2	0.8	0.0	0.0		W by S.	4.0
		18	0	442	47.5	45.5	2.0	0.0	0.0		NW ?	9.8
		19	0	427	50.0	47.2	2.8	0.3	0.2	SW by W.		9.9
		20	0	409	51.3	48.5	2.8	0.4	0.2	SW.	NW ?	10.0
		21	0	389	54.0	50.8	3.2	0.5	0.3	SW.	W by S.	10.0
		22	0	373	53.6	50.6	3.0	0.6	0.4	SW.	WSW.	10.0
		23	0	356	51.6	49.9	1.7	0.6	0.3	SW.		10.0
July	20	0	0	326	51.2	50.1	1.1	0.5	0.4	SW by S.		10.0
		1	0	287	52.2	51.2	1.0	0.4	0.7	SW.		10.0
		2	0	260	53.8	52.2	1.6	0.6	0.2	SW.	W.	10.0
		3	0	239	55.0	52.6	2.4	1.1	0.8	WSW.		10.0
		4	0	228	55.9	53.0	2.9	1.3	0.3	SW.	W by S.	10.0
		5	0	215	55.9	53.1	2.8	0.7	0.2	SW.	W.	10.0
		6	0	205	56.4	53.0	3.4	0.8	0.4		W.	10.0
		7	0	212	55.7	52.1	3.6	1.3	1.0		W.	10.0
		8	0	214	55.1	52.0	3.1	1.0	0.8	WSW.	WNW.	9.0
		9	0	221	54.8	51.4	3.4	0.9	0.2	SW by S.	WNW : NW.	7.0
		10	0	232	52.7	50.8	1.9	0.9	0.5	W by S.	NW.	7.0
Aug.	25	10	0	29.545	56.6	54.9	1.7	0.2	0.0	SW by S.		3.5
		11	0	571	55.6	54.1	1.5	0.2	0.0	SW by S.		6.0
		12	0	578	52.8	52.2	0.6	0.0	0.0			1.5
		13	0	580	50.7	50.4	0.3	0.0	0.0			0.5
		14	0	592	49.0	48.7	0.3	0.0	0.0			0.7
		15	0	592	48.8	48.0	0.8	0.0	0.0			1.0
		16	0	599	47.5	47.5	0.0	0.0	0.0			1.5
		17	0	603	49.0	48.7	0.3	0.0	0.0			3.5
		18	0	608	50.2	49.8	0.4	0.0	0.0			5.0
		19	0	621	48.6	48.6	0.0	0.0	0.0		SSW ? : SSW.	1.7
		20	0	622	53.2	51.8	1.4	0.0	0.0			1.0
		21	0	619	57.0	55.0	2.0	0.1	0.0		SW.	2.0
		22	0	616	61.2	57.9	3.3	0.6	0.3	SSW.	SW.	5.0
		23	0	615	62.9	57.6	5.3	0.5	0.1	SW by S.	SW.	8.0
Aug.	26	0	0	614	64.0	58.0	6.0	0.6	0.1	SW.	SW.	9.0
		1	0	610	64.3	58.2	6.1	0.4	0.2	SW by S.	SW by S.	7.0
		2	0	604	65.2	59.0	6.2	0.2	0.1	SW.	SW.	8.0
		3	0	601	59.0	57.2	1.8	0.1	0.0		SW.	10.0
		4	0	616	53.4	53.3	0.1	0.4	0.0	SW.	SW.	10.0
		5	0	608	54.9	54.5	0.4	0.0	0.0		SW.	10.0
		6	0	625	53.7	53.4	0.3	0.3	0.4	WSW.	SW.	9.8
		7	0	643	53.9	52.9	1.0	0.2	0.1	SW.	WSW.	7.0

SPECIES OF CLOUDS, &c.		Observer's Initial.
h.	m.	
22	0.	B
22	30.	B
23	0.	B
23	30.	B
0	0.	B
0	30.	B
1	0.	B
1	30.	B
2	0.	B
10	0. Scud.	B
11	0. Id.	B
12	0. A streak of light to NNE.	H
13	0. Id.	H
14	0. Scud.	D
15	0. Id. ; very red to E.	B
16	0. Cirro-cumulous scud ; sky red to E.	B
17	0. Id. + linear cirri ; scud on Cheviot.	B
18	0. Scud + cirro-strati on E. horizon.	H
19	0. Id. + id.	H
20	0. Id.	H
21	0. Id. + cirrous clouds.	W
22	0. Id. ; light rain.	W
23	0. Rain.	W
0	0. Id.	W
1	0. Id.	W
2	0. Scud ; light rain.	W
3	0. Id. ; id.	W
4	0. Id.	W
5	0. Id. ; passing showers.	B
6	0. Id. ; the sun's disc just visible through thick cirrous haze.	B
7	0. Id.	D
8	0. Id. + cirrous clouds.	D
9	0. Loose scud : cirro-cumuli and cirrous scud.	W
10	0. Scud + cirro-cumuli and cirrous clouds ; dark mass of scud to E.	W
10	0. Scud.	W
11	0. Cirrous clouds and cirro-strati.	B
12	0. Loose cumuli ? ; cirro-strati.	B
13	0. Cirro-strati.	B
14	0. Id.	D
15	0. Id. ; a small patch of cumulus to S.	D
16	0. Cirrous haze, linear cirri, and cirro-strati.	B
17	0. Fine linear cirri and cirrous haze, becoming thick to E.	B
18	0. Cirrous scud to W. : feathered and woolly cirri to S. + thick mass of linear cirri and cirrous haze to E.	B
19	0. Nearly as before.	D
20	0. Cirri and haze.	D
21	0. Masses of scud + cirro-strati to W. ; cirrous haze on E. horizon.	W
22	0. Scud and loose cumuli.	W
23	0. Id. + cirrous clouds to W.	W
0	0. Id. + id.	W
1	0. Scud + cirro-cumuli and cirro-strati.	H
2	0. Scud and cumuli ; dark scud to SW.	H
3	0. Dark electric scud ; thunder ; a shower lately and a heavy one immediately.	W
4	0. Scud + thick cirrous haze.	W
5	0. Thick, nearly homogeneous cirrous mass + patches of scud near horizon.	W
6	0. Scud + cumuli on S. horizon ; heavy shower.	W
7	0. Cirrous scud + cirro-strati and scud to E.	W

TERM-DAY AND EXTRA METEOROLOGICAL

Göttingen Mean Time of Observation.			BAROMETER Corrected.	THERMOMETERS.			ANEMOMETER.			Clouds moving from	Quantity of Clouds.
				Dry.	Wet.	Diff.	Pressure.		Direction of Wind.		
							Max.	Pres.			
Aug. 26	d. h. m.		in.	°	°	°	lbs.	lbs.		0-10.	
	8 0	29.651	50.9	50.3	0.6	0.4	0.0			2.5	
	9 0	678	49.8	49.3	0.5	0.0	0.0			1.0	
	10 0	697	51.0	50.3	0.7	0.2	0.2	SW.		0.3	
Sept. 18	12 0	29.988	47.7	46.8	0.9	0.1	0.0			3.0	
Sept. 20	10 0	29.790	59.3	57.8	1.5	1.2	0.3			1.0	
	11 0	783	59.7	58.2	1.5	0.8	0.5		WSW ?	6.0	
	12 0	770	58.9	57.9	1.0	0.5	0.3			1.5	
	13 0	769	59.6	58.3	1.3	1.0	0.3			2.5	
	14 0	769	59.0	57.6	1.4	0.4	0.1	SW.		1.0	
	15 0	779	58.0	56.7	1.3	0.2	0.2	WSW.		3.0	
	16 0	776	59.2	56.4	2.8	0.3	0.3	SW.		1.5	
	17 0	775	58.8	56.4	2.4	0.6	0.1	SW.		3.0	
	18 0	797	59.7	56.6	3.1	0.6	0.1		W by S.	9.5	
	19 0	813	59.7	56.7	3.0	0.8	0.5	WSW.	W.	9.5	
	20 0	833	60.7	57.4	3.3	0.9	0.3	SW.		9.7	
	21 0	862	62.2	58.7	3.5	0.5	0.0		W.	8.0	
	22 0	874	63.5	59.0	4.5	0.3	0.3	W.	W.	7.0	
	23 0	893	63.0	58.0	5.0	0.5	0.4	NW by N.	W.	7.0	
Sept. 21	0 0	908	64.3	58.0	6.3	1.0	0.7	NW.	W by N.	3.0	
	1 0	923	63.6	57.2	6.4	0.6	0.5	WSW.		3.5	
	2 0	935	63.4	56.5	6.9	0.9	0.5	W.	W by N.	2.0	
	3 0	944	64.2	57.0	7.2	0.4	0.2		WNW.	1.0	
	4 0	958	64.9	57.6	6.3	0.3	0.1			0.5	
	5 0	971	62.9	57.5	5.4	0.4	0.3	NNW.		1.5	
	6 0	29.990	60.9	55.8	5.1	0.2	0.0			0.2	
	7 0	30.008	56.3	53.6	2.7	0.0	0.0			0.5	
	8 0	042	51.1	50.1	1.0	0.0	0.0			0.0	
	9 0	073	48.0	47.7	0.3	0.0	0.0			0.0	
	10 0	082	47.2	46.1	1.1	0.0	0.0			0.0	
	11 0	099	49.1	47.9	1.2	0.0	0.0			0.0	
	12 0	109	47.0	46.2	0.8	0.0	0.0			0.0	
	13 0	118	45.3	44.8	0.5	0.0	0.0			0.0	
	14 0	145	44.6	44.3	0.3	0.0	0.0			0.0	
	15 0	148	43.2	43.0	0.2	0.0	0.0			0.0	
	16 0	162	43.2	42.7	0.5	0.0	0.0			0.0	
	17 0	167	42.4	42.3	0.1	0.0	0.0			0.0	
	18 0	190	41.9	41.8	0.1	0.0	0.0			0.1	
	19 0	210	40.8	40.8	0.0	0.0	0.0			0.5	
	19 30	225	42.6	42.0	0.6	0.0	0.0		NE.	2.0	
	20 0	231	45.7	45.0	0.7	0.0	0.0			0.8	
	21 0	248	49.2	48.1	1.1	0.0	0.0			0.1	
	22 0	264	52.4	51.0	1.4	0.0	0.0			0.0	
	23 0	267	56.6	54.4	2.2	0.0	0.0			0.1	
Sept. 22	0 0	266	59.4	56.0	3.4	0.1	0.0	WNW ?		0.0	
	1 0	261	63.0	58.7	4.3	0.0	0.0			0.0	
	2 0	250	66.2	59.3	6.9	0.0	0.0			0.0	
	3 0	244	68.8	61.7	7.1	0.0	0.0			0.2	
	4 0	244	69.7	60.3	9.4	0.0	0.0			0.2	
	5 0	246	69.2	61.7	7.5	0.0	0.0			0.2	
	6 0	264	64.1	60.3	3.8	0.0	0.0			0.2	
	7 0	273	60.0	58.3	1.7	0.1	0.0			0.0	
	8 0	279	55.3	55.0 ?	0.3 ?	0.1	0.0	NE.		0.3	
	9 0	288	53.3	52.1	1.2	0.0	0.0			0.0	
	10 0	301	51.0	49.7	1.3	0.0	0.0			0.0	
Oct. 18	10 0	30.014	30.3	29.6	0.7	0.0	0.0			0.0	

SPECIES OF CLOUDS, &c.		Observer's Initial.
h. m.		
8	0. Scud and cirrous clouds near horizon.	W
9	0. Id.	W
10	0. Scud.	W
12	0. Faint Aurora.	
10	0. Cirro-strati to N.	D
11	0. Scud + cirro-strati.	D
12	0. Cirro-strati.	D
13	0. Id.	D
14	0. Id. and scud. 14h 35m. Bright Auroral light from NW. by N. to N., extending from the horizon to about 12° altitude; no streamers	W
15	0. Scud. The Aurora has disappeared.	W
16	0. Masses of scud.	W
17	0. Id.; cirro-strati on E. horizon.	W
18	0. Scud + cirro-strati on E. horizon.	D
19	0. Id. + id.	W
20	0. Id. + cirrous clouds.	W
21	0. Id. + feathered and woolly cirri.	W
22	0. Id. + id.	W
23	0. Id. + cirro-cumuli.	H
0	0. Cirrous-edged and loose cumuli + curled, feathered, and mottled cirri.	B
1	0. Masses of loose cumuli + woolly and curled cirri.	H
2	0. Masses of scud + cirri and cirro-strati to E.	W
3	0. Loose cumuli + cirro-strati to S.	B
4	0. Id. + id.	D
5	0. Loose patches of scud; cumuli on S. horizon; haze on E. horizon.	D
6	0. Cirro-strati on S. horizon; cirrous haze on E. horizon.	B
7	0. Thick cirrous haze to E.	W
8	0. Clear.	B
9	0. Id.	H
10	0. Id.	H
11	0. Id.	H
12	0. Id.	H
13	0. Id.	H
14	0. Id.	H
15	0. Id.	H
16	0. Id.	H
17	0. Id.	H
18	0. A streak of cirro-stratus to NE.; light fog.	B
19	0. Foggy; cirro-strati to NE., moving down E. horizon.	B
19 30	Sky covered with scud.	B
20	0. Cirrous scud to N. and NE.	B
21	0. Strips of hazy cirro-stratus on E. horizon.	B
22	0. Clear.	W
23	0. A small patch of scud to NE.	W
0	0. Clear.	W
1	0. Id.	W
2	0. Id.	W
3	0. Cirro-strati to NW.	W
4	0. A few patches of hazy cirro-stratus to NNW.	W
5	0. Id.	W
6	0. Id.	W
7	0. Clear.	W
8	0. Patches of cirro-strati to NNW.	W
9	0. Clear.	W
10	0. Id.	W
10	0. Id.	W

Göttingen Mean Time of Observation.			BAROMETER Corrected.	THERMOMETERS.			ANEMOMETER.			Clouds moving from	Quantity of Clouds.	
				Dry.	Wet.	Diff.	Pressure.		Direction of Wind.			
							Max.	Pres.				
d.	h.	m.	in.	°	°	°	lbs.	lbs.		0-10.		
Oct.	18	11	0	30.029	30.0	28.3	1.7	0.0	0.0		0.0	
		12	0	041	28.0	0.0	0.0		0.0	
		13	0	061	26.6	0.0	0.0		0.0	
		14	0	078	26.0	0.0	0.0		0.0	
		15	0	090	23.7	23.7	0.0	0.0	0.0		0.2	
		16	0	102	23.9	23.4	0.5	0.0	0.0		0.0	
		17	0	115	23.9	23.5	0.4	0.0	0.0		0.5	
		18	0	120	24.0	23.6	0.4	0.0	0.0		0.0	
		19	0	139	24.0	24.0	0.0	0.0	0.0		0.0	
		20	0	153	26.2	26.0	0.2	0.0	0.0		8.0	
		21	0	151	29.1	27.2	1.9	0.0	0.0		7.0	
		22	0	152	33.0	31.0	2.0	0.0	0.0		7.0	
		Oct.	19	0	0	154	35.3	32.2	3.1	0.0	0.0	W.
0	0			161	40.4	35.9	4.5	0.1	0.1	W by S.	2.0	
1	0			147	42.9	38.7	4.2	0.4	0.3	WSW.	0.3	
2	0			124	44.4	39.3	5.1	0.3	0.2	W by S.	0.2	
3	0			115	45.0	39.5	5.5	0.3	0.2	W by S.	0.2	
4	0			110	44.7	39.8	4.9	0.4	0.4	WSW.	0.2	
5	0			104	41.9	38.9	3.0	0.3	0.2		2.0	
6	0			107	39.6	37.2	2.4	0.3	0.1	SW.	0.5	
7	0			098	38.3	36.6	1.7	0.1	0.0		4.0	
8	0			079	39.2	37.2	2.0	0.1	0.0		4.0	
9	0	069	36.7	35.3	1.4	0.1	0.0		2.0			
10	0	061	37.2	36.0	1.2	0.0	0.2		1.0			
Oct.	27	22	0	28.522	45.9	45.2	0.7	2.7	2.0	E by N.	10.0	
		23	0	464	46.1	45.6	0.5	2.2	1.5	NE.	E by S. E by N.	10.0
Oct.	28	0	0	427	48.0	47.0	1.0	2.6	0.8	E.	ESE.	10.0
		0	5	417								
		0	30	422								
		1	30	431								
		2	0	423	45.1	43.0	2.1	1.5	0.8	E.	ESE.	9.9
		3	30	425								
4	0	424	43.7	41.8	1.9	1.3	0.3	NE.	E by N : E.	9.9		
Nov.	2	12	0	29.571	33.0	32.0	1.0	0.0	0.0		SSE.	1.0
Nov.	24	10	0	29.460	34.0	32.6	1.4	0.0	0.0			10.0
		11	0	465	30.8	0.0	0.0			0.2
		12	0	477	34.0	32.0	2.0	0.0	0.0			10.0
		13	0	476	34.2	33.7	0.5	0.0	0.0			9.5
		14	0	474	34.8	34.1	0.7	0.0	0.0			10.0
		15	0	460	33.9	33.3	0.6	0.0	0.0			9.0
		16	0	446	34.0	33.6	0.4	0.0	0.0			8.5
		17	0	430	28.3	0.0	0.0			0.5
		18	0	430	29.5	0.0	0.0			2.0
		19	0	435	30.0	0.0	0.0			9.5
		20	0	429	29.8	0.0	0.0			10.0
		21	0	424	30.8	0.0	0.0			10.0
		22	0	423	33.3	31.6	1.7	0.0	0.0			10.0
23	0	422	33.7	32.2	1.5	0.0	0.0			10.0		
Nov.	25	0	0	390	34.3	33.6	0.7	0.0	0.0		W.	9.0
		1	0	368	35.3	34.4	0.9	0.0	0.0		S.	9.0
		2	0	383	36.7	35.6	1.1	0.0	0.0			9.7
		3	0	385	35.7	35.0	0.7	0.0	0.0		W : NW.	10.0
		4	0	387	35.3	34.7	0.6	0.0	0.0		W.	9.7
5	0	364	31.0	0.0	0.0			2.0		

SPECIES OF CLOUDS, &c.		Observer's Initial.
h.	m.	
11	0. Clear.	W
12	0. Id.	W
13	0. Id.	W
14	0. Id.	D
15	0. Cirro-strati to E.	W
16	0. Clear.	W
17	0. Slight cirrous haze to E. ; faint lunar halo.	W
18	0. Cirro-strati to E.	W
19	0. Id., tinged with red.	H
20	0. Cirro-strati on horizon ; cumuli.	H
21	0. Cirro-cumuli ; haze on horizon.	H
22	0. Woolly cirri, moving slowly + patches of mottled cirri.	H
23	0. Diffuse and mottled cirri.	B
0	0. Woolly, mottled, and linear cirri and cirro-strati.	W
1	0. Cirro-strati to S.	W
2	0. Id.	B
3	0. Cirrous haze ; patches of scud to S.	B
4	0. Cirro-strati and cirrous haze on NNE. horizon.	W
5	0. Haze with patches of scud.	D
6	0. Cirrous haze and cirro-strati.	W
7	0. Cirrous clouds and haze.	C
8	0. Id.	D
9	0. Cirrous clouds on horizon.	W
10	0. Cirro-strati and cirrous haze.	B
22	0. Loose scud ; drizzle ; Scotch mist.	W
23	0. Scud ; light drizzle.	W
23	30.	
0	0. Loose scud.	W
0	5.	W
0	30.	W
1	30.	W
2	0. Scud and loose cumuli, breaking to E.	W
3	30.	
4	0. Loose scud : woolly cirri + diffuse cirri to W.	B
12	0. Patches of scud + cirro-strati to N.	
10	0. Sky covered with thin clouds.	W
11	0. Scud ?	W
12	0. Id.	H
13	0. Clear on E. horizon.	H
14	0.	D
15	0. Cirrous clouds ?	B
16	0. Scud ? ; sky to E. and S.	B
17	0. Clouds on horizon.	B
18	0. Id. ; cirrous haze.	H
19	0. Cirrous haze ; stars of the third magnitude are visible in the zenith.	B
20	0. Woolly cirri and cirrous haze ; cirro-strati to S. and E.	B
21	0. Thick woolly scud + cirro-strati to NE. ; cirrous haze.	B
22	0. Snowing.	H
23	0. Thick cirrous mass ; cirro-cumulous scud below to N.	W
0	0. Large woolly cirro-cumuli, moving slowly.	W
1	0. Cirrous scud and loose cumuli.	W
2	0. Id.	W
3	0. Massive, zigzag, thunderbolt cirro-strati, radiating from S. : woolly cirri.	H
4	0. Cirrous scud and woolly cirri.	W
5	0. Flame cirri to S. ; cirrous haze.	W

Göttingen Mean Time of Observation.			BAROMETER Corrected.	THERMOMETERS.			ANEMOMETER.			Clouds moving from	Quantity of Clouds.		
				Dry.	Wet.	Diff.	Pressure.		Direction of Wind.				
							Max.	Pres.					
d.	h.	m.	in.	°	°	°	lbs.	lbs.		0-10.			
Nov.	25	6	0	29.364	30.2	0.0	0.0		2.0		
		7	0	375	28.3	0.0	0.0		0.5		
		8	0	366	29.3	0.0	0.0		10.0?		
		9	0	368	31.7	31.7	0.0	0.0	0.0		10.0		
		10	0	339	30.4	0.0	0.0		7.0		
Dec.	10	13	0	29.942	46.8	44.7	2.1	0.5	0.2	SSW.	SW.	10.0	
		14	0	29.939	47.0	44.8	2.2	0.2	0.2	SSW.		10.0	
Dec.	11	12	0	30.087	47.0	46.1	0.9	0.1	0.0			10.0	
Dec.	20	10	0	29.891	47.7	45.6	2.1	0.5	0.2	SW.		10.0	
		11	0	893	48.3	46.3	2.0	0.9	0.7	SW.		10.0	
		12	0	896	49.3	46.8	2.5	1.5	0.2	SW ?		9.0	
		13	0	899	48.2	46.4	1.8	0.4	0.3	SSW.		10.0	
		14	0	872	47.6	46.1	1.5	1.0	1.5	SW ?		10.0	
		15	0	870	48.3	46.9	1.4	1.0	0.5	SSW.		10.0	
		16	0	892	48.4	47.9	0.5	0.8	0.6	SW.		10.0	
		17	0	927	46.4	45.8	0.6	1.0	0.1	W.		10.0	
		18	0	940	45.5	44.5	1.0	0.0	0.0			7.0	
		19	0	971	39.9	39.7	0.2	0.0	0.0			0.2	
		20	0	29.994	39.0	39.0	0.0	0.0	0.0		W.	0.2	
		21	0	30.022	42.1	41.5	0.6	0.0	0.0			0.5	
		22	0	055	38.9	38.7	0.2	0.1	0.0	SW.	WNW ?	0.2	
		23	0	073	43.0	41.5	1.5	0.1	0.1			0.2	
	Dec.	21	0	077	42.9	41.8	1.1	0.1	0.1	SSW.	WNW.	5.0	
			1	0	081	43.4	42.2	1.2	0.1	0.2	SW by S.		3.0
			2	0	086	45.0	43.6	1.4	0.2	0.0			0.5
			3	0	101	43.5	42.5	1.0	0.0	0.0		W by N.	4.0
			4	0	103	40.8	40.6	0.2	0.0	0.0			1.5
			5	0	113	37.4	37.2	0.2	0.0	0.0			2.0
			6	0	109	37.1	37.0	0.1	0.0	0.0			2.0
			7	0	117	38.7	38.5	0.2	0.0	0.0			9.7
			8	0	105	39.6	39.3	0.3	0.0	0.0			3.0
		9	0	083	39.1	38.7	0.4	0.0	0.0			0.5	
		10	0	066	38.6	38.0	0.6	0.0	0.0			0.5	
		11	0	061	39.0	38.8	0.2	0.0	0.0			9.5	
		12	0	046	39.4	39.2	0.2	0.0	0.0			4.0	
		13	0	018	40.0	39.7	0.3	0.0	0.0			9.7	
		14	0	30.002	40.7	40.4	0.3	0.0	0.0			7.0	
	15	0	29.979	41.3	40.9	0.4	0.0	0.0			10.0		
	16	0	957	45.3	44.7	0.6	0.2	0.2	SSW.		9.0		
	17	0	940	46.1	45.3	0.8	0.9	1.0	S by W.	W ?	3.0		
	18	0	925	44.2	43.7	0.5	0.3	0.0		WSW ?	3.0		
	19	0	897	44.1	43.6	0.5	0.0	0.0		WSW ?	9.5		
	21	0	845	46.6	44.7	1.9	0.7	0.5	SSW.	SW : SW.	8.0		
	23	0	808	50.0	47.7	2.3	3.7	...		SW by S.	10.0		
Dec.	22	0	0	759	51.0	48.6	2.4	2.8	1.4	SSW.	SSW.	10.0	
		1	0	718	50.0	49.3	1.5	2.1	1.4	SSW.	SW by S.	10.0	
		2	0	691	53.0	51.0	2.0	4.5	3.4	SW by S.	SW by S.	10.0	
		3	0	659	53.8	51.6	2.2	4.8	3.1	SSW.	SW ½ S : SW ½ W.	10.0	
		4	0	636	53.7	51.8	1.9	6.0	4.8	SW by S.	SW ½ W.	7.0	
		5	0	647	54.2	50.9	3.3	5.4	5.4	SSW.	SW : WSW.	9.0	
		6	0	631	53.7	50.5	3.2	7.3	5.6	SSW.	SW ?	7.0	
		7	0	665	52.9	49.1	3.8	5.9	3.7	SW by S.	SW.	2.5	
		8	0	660	52.2	48.2	4.0	5.8	3.9	SW by S.		7.5	
		10	0	710	51.0	46.8	4.2	4.7	2.1	SW by S.		10.0	

SPECIES OF CLOUDS, &c.

Observer's
Initial.

h.	m.		
6	0.	Foggy; cirrous clouds.	D
7	0.	Cirro-strati to S. and E.	H
8	0.	Thick fog.	B
9	0.	Id.	D
10	0.	Id.	W
13	0.	Scud.	B
14	0.		
12	0.		
10	0.	Scud.	W
11	0.	Id.	W
12	0.	Id.	W
13	0.	Id.	D
14	0.	Slight rain.	D
15	0.	Id.	D
16	0.	Rain heavier.	D
17	0.	Light rain.	D
18	0.	Strata of clouds lying ENE. to WSW.	B
19	0.	Cirro-strati on E. horizon.	B
20	0.	Scud to S. + ribbed cirri; cirro-strati on E. horizon.	B
21	0.	Patches of scud on N. and S. horizon; woolly cirri; cirro-strati to S.	B
22	0.	Patches of scud + cirro-strati and cirrous haze to SE.	W
23	0.	Patches of cirrous clouds and haze.	H
0	0.	Woolly and linear cirri.	H
1	0.	Woolly and mottled cirro-strati on horizon.	H
2	0.	Patches of mottled and woolly cirri; cirrous haze and cirro-strati on horizon.	W
3	0.	Woolly cirri and thin woolly cirro-cumuli.	W
4	0.	Cirro-cumuli and woolly cirri to NW.; cirrous haze on horizon.	W
5	0.	Cirro-cumuli to W.; cirrous haze to E.; cirro-strati to N.	B
6	0.	Sheets of cirro-strati reaching from SSW. to E.	B
7	0.	Scud.	W
8	0.	Clouds on E. and S. horizon.	H
9	0.	Streaks of clouds.	W
10	0.	Id.	W
11	0.	Loose scud.	W
12	0.	Id.	W
13	0.	Id.	W
14	0.	Id.	W
15	0.	Id.	W
16	0.	Id.	W
17	0.	Id.	W
18	0.	Scud + cirro-strati and cirrous haze to E.	B
19	0.	Id. + id.	B
21	0.	Thin gray smoky scud: beautifully mottled cirri and bunches of woolly cirri, coloured orange-yellow - linear cirri and cirro-strati to E.	B
23	0.	Scud.	B
0	0.	Id.	W
1	0.	Id. In strong gusts of wind the vane indicates SW. by S.	
2	0.	Id.	W
3	0.	Id.: masses of cirri.	
4	0.	Id.; clouds just clearing off.	B
5	0.	Two currents of scud.	
6	0.	Scud.	B
7	0.	Id.	
8	0.	Id.	W
10	0.	Id.	W

Göttingen Mean Time of Observations.		Temperature of Water.			Göttingen Mean Time of Observations.		Temperature of Water.			Göttingen Mean Time of Observations.		Temperature of Water.		
		Pump Wells.		River Tweed.			Pump Wells.		River Tweed.			Pump Wells.		River Tweed.
		Cottage.	Garden.				Cottage.	Garden.				Cottage.	Garden.	
d.	h.	°	°	°	d.	h.	°	°	°	d.	h.	°	°	°
1842.					1843.					1843.				
Oct.	12 2	51.3	Feb.	18 4	43.2	46.0	32.4	Aug.	13 18	62.6
	14 2	50.3		27 4	42.9	45.8	36.1		14 7	66.8
	15 2	52.2	March	4 4	42.7	45.8	37.1		17 7	70.2
	17 2	49.6		11 4	42.7	45.7	39.9		18 7	70.6
	18 2	47.8		18 4	42.8	45.9	44.2		19 7	49.5	49.5	72.3
	20 2	40.1		27 4	42.9	45.8	37.8		29 4	50.1	49.6
	24 2	41.5	April	1 4	43.1	45.8	48.5		31 6	61.6
	25 2	37.8		8 4	43.5	46.1	45.3	Sept.	2 8	50.3	49.6
	27 2	37.7		15 4	43.7	46.0	49.7		7 6	65.5
	28 2	40.0		22 4	44.0	46.2	51.3		8 7	66.1
	29 2	40.7		29 4	44.1	46.1	47.8		9 7	66.8
	31 2	43.6	May	6 4	44.5	46.2	52.2		11 4	50.6	49.7	65.6
Nov.	1 2	47.0		13 4	45.0	46.7	54.7		12 7	65.6
	2 1	48.6		20 6	45.2	46.8	52.4		18 22	50.6	49.5
	3 4	49.5	48.8	45.9		29 4	45.7	47.1	50.4		20 7	61.9
	5 4	49.3	48.9	41.5	June	3 4	45.9	47.7	47.6		21 4	63.3
	7 4	49.2	42.0		10 4	46.4	48.6	53.3		23 4	50.6	49.6
	12 4	48.7	48.3	42.0		17 7	46.6	49.5	65.4		25 1	57.4
	19 5	47.9	48.1	39.0		24 9	46.8	49.7	66.6		30 4	50.7	49.5	54.8
	28 4	47.2	48.0	41.0*	July	1 9	47.4	50.0	Oct.	7 4	50.7	49.5	55.6
Dec.	19 4	46.9	48.3	40.9		3 8	58.0		11 22	42.1*
1843.														
Jan.	2 4	46.1	48.0		7 18	59.8		16 4	50.6	49.5
	5 3	35.1		8 4	47.7	50.2		21 6	50.5	49.3
	11 4	45.4	47.2	32.6		11 3	67.1		28 4	49.6	49.2
	16 4	45.1	46.9	32.2		15 4	48.5	50.5	66.7	Nov.	4 4†	48.8	48.9
	24 3	41.3		22 6	48.6	50.1	Dec.	2 4	46.7	48.5
	28 4	44.6	47.2	44.8	Aug.	4 18	58.2		9 4	46.7	48.6
Feb.	4 4	44.3	46.7	32.3		5 4	49.4	49.9		16 4	46.7	48.7
	11 4	44.1	46.4	35.8		12 5	49.4	49.8	65.0		23 4	46.7	48.7
											30 4	46.7	48.6

* Tweed in flood.

† The thermometer used before this was broken.

ABSTRACTS OF THE RESULTS
OF THE
MAGNETICAL OBSERVATIONS,

MADE AT THE OBSERVATORY OF

GENERAL SIR T. M. BRISBANE, BART.,

MAKERSTOUN.

1843.

In order to avoid repetition, it may be remarked generally,—

First, That the results for the month of January are more imperfect than those for the succeeding months, as on the first week of 1843 only four daily observations were made, and on the second week only eight. Attempts have been made to render the means comparable and as complete as possible, by means of observations made at all the 24 hours in 1844: these will be found explained after the various Tables.

Second, In obtaining the hourly means for the month of January the first week's observations were wholly rejected.

Third, It is obvious that the daily means from the nine observations, whatever attempts at correction may have been made, are imperfect, and that the results deduced from these means cannot be expected to be so distinct as they would have been from twelve two-hourly observations.

Fourth, As no observations were made on Sundays, the places which the means for Sundays would have occupied have been filled up by the means of the three preceding and three succeeding days; these means are therefore weekly means, and may be considered as approximate means for the Sundays. They have been used in the summations having reference to the moon's position, as it was considered that the want of any means on these days would affect the accuracy of the results more seriously than the use of the approximations.

Fifth, The time used in all the Tables is Göttingen mean time *astronomical* reckoning; but in the *Remarks* on the Tables, Makerstoun mean time *civil* reckoning is used, unless the reverse is stated; thus 20^h in the Tables is equivalent to 7^h 10^m A.M. in the *Remarks*.

TABLE I.—Mean Westerly Declination for each Civil Day, as deduced from the Nine Daily Observations, for each Week, and for each Month in the year 1843.

Civil Day.	January.	February.	March.	April.	May.	June.	July.	August.	September.	October.	November.	December.
	25°	25°	25°	25°	25°	25°	25°	25°	25°	25°	25°	25°
1	[.....]	25.15	24.67	25.46	23.18	25.74	26.29	22.45	22.71	[23.93]	18.92	17.48
2	27.67	25.32	24.98	[24.98]	26.43	[26.02]	22.41	23.28	23.76	20.73	20.03
3	26.49	25.22	24.92	25.76	24.04	27.07	26.66	22.55	[22.41]	25.04	21.95	[19.16]
4	26.77	24.28	25.43	26.22	24.87	[25.96]	26.79	23.11	20.03	24.01	21.95	19.23
5	27.01	[24.80]	[25.87]	25.09	24.01	25.82	26.78	22.26	23.20	24.20	[21.35]	19.44
6	27.08	21.34	25.95	27.98	22.15	25.01	23.99	[22.88]	22.12	22.71	22.60	21.46
7	24.26	26.41	28.51	24.52	[23.42]	25.70	23.45	22.15	20.80	22.97	21.31	20.52
8	[25.57]	26.25	25.43	24.54	23.54	25.34	27.42	21.96	21.42	[23.20]	19.56	20.14
9	25.48	26.58	25.50	[25.02]	22.82	24.17	[24.98]	25.27	22.71	23.04	20.12	20.70
10	25.24	26.35	24.84	24.42	23.13	25.67	26.28	22.91	[21.92]	23.27	19.32	[20.48]
11	24.33	25.11	24.81	23.87	24.40	[25.88]	24.72	22.69	23.45	23.02	19.10	20.13
12	23.73	[25.52]	[24.92]	24.78	25.00	26.09	24.00	22.93	22.63	23.03	[19.42]	20.86
13	24.85	24.06	26.54	25.10	24.20	25.27	24.25	[23.28]	20.54	24.09	19.99	20.54
14	25.55	26.28	24.21	24.90	[24.77]	28.75	22.24	23.52	20.39	23.73	18.90	20.72
15	[25.47]	24.72	23.60	24.12	25.45	28.37	23.97	24.25	20.30	[23.17]	19.08	20.73
16	26.73	24.66	23.36	[24.59]	25.95	28.33	[23.35]	23.41	20.41	22.66	19.16	20.58
17	25.63	25.70	24.20	24.56	23.62	28.14	23.84	23.17	[20.65]	22.96	19.26	[20.05]
18	26.35	24.92	25.98	25.07	24.28	[25.26]	22.16	23.64	20.33	22.56	19.87	19.63
19	28.64	[25.17]	[25.28]	23.77	24.19	23.05	23.67	24.01	21.18	19.33	[19.32]	18.85
20	29.34	24.47	25.76	22.72	23.29	21.56	22.22	[23.79]	21.27	21.62	19.45	19.77
21	27.84	25.25	25.73	23.82	[23.72]	22.11	23.73	23.20	19.97	21.84	18.73	18.24
22	[26.95]	26.01	26.63	23.70	23.84	23.33	26.66	21.66	[21.62]	19.47	18.30
23	24.80	25.71	25.90	[23.47]	22.66	[23.32]	22.04	21.35	22.32	18.92	18.29
24	25.03	28.69	25.13	23.74	24.05	27.90	20.57	21.24	[21.00]	22.23	19.27	[18.54]
25	26.06	25.97	24.80	23.45	24.95	[26.74]	26.13	22.82	20.32	22.37	18.81	18.49
26	25.48	[26.08]	[24.48]	23.38	24.18	26.52	23.96	21.88	21.02	20.14	[18.85]	19.06
27	26.21	25.70	24.89	23.84	23.09	26.19	23.74	[22.36]	21.66	21.36	18.72	18.84
28	25.51	25.75	23.75	23.19	[24.72]	26.37	22.80	23.30	24.78	21.28	18.92	20.43
29	[25.36]		22.40	23.05	24.98	23.14	22.81	23.02	22.74	[20.67]	18.49	18.38
30	24.99		23.36	[23.46]	26.23	26.46	[22.88]	21.88	23.24	21.95	17.31	18.51
31	24.85		24.02		24.91		23.05	23.11		20.35		[19.85]
Mean	26.00	25.41	25.01	24.44	24.12	25.80	24.19	23.03	21.67	22.53	19.61	19.59

The quantities in brackets are the means of the three preceding and of the three succeeding numbers; they are, therefore, the weekly means, and they may be considered as the approximate westerly declinations on the Sundays, whose place they occupy, and on which no observations were made.

The means for the first week in January are means of the four daily observations in that week corrected by $-0\cdot84$. The means in the second week are the means of the eight daily observations in that week corrected by $-0\cdot14$. These corrections were obtained by comparing the observations at the four and eight corresponding hours in 1844 with the observations at the nine hours corresponding to the observing hours in 1843.

ANNUAL PERIOD OF DECLINATION.

Differences of the mean westerly declination, deduced from the observations made in 1844 at the hours 18, 20, . . . 10, from that deduced from the 24 hourly observations made on each day (excepting Sundays) in that year.

24 Observations minus 9 Observations :—

Jan.	Feb.	March.	April.	May.	June.	July.	Aug.	Sept.	Oct.	Nov.	Dec.
$-0\cdot33$	$-0\cdot47$	$-0\cdot75$	$-0\cdot49$	$-0\cdot85$	$-0\cdot58$	$-0\cdot56$	$-0\cdot68$	$-0\cdot75$	$-0\cdot76$	$-0\cdot73$	$-0\cdot35$

The *variation* of these differences is not sufficiently great to affect the character of the annual period, as deduced from the monthly means at the foot of the previous Table. When these quantities are subtracted from the monthly means of the nine observations in 1843 we obtain the following :—

Jan.	Feb.	March.	April.	May.	June.	July.	Aug.	Sept.	Oct.	Nov.	Dec.
25\cdot67	24\cdot99	24\cdot26	23\cdot95	23\cdot27	25\cdot22	23\cdot63	22\cdot35	20\cdot92	21\cdot77	18\cdot88	19\cdot24

From these we see that the westerly declination diminishes very regularly till May, increases considerably from May to June, diminishes again regularly to November, with the exception of an increase in October, which, however, is nearly made up for by the more rapid diminution in November; in December there is a slight increase.

It will be found, Table III., that the retrogressive or secular change of westerly declination has a value of about 6' in one year; if we add proportional parts of this to the different monthly means, the annual period will be more distinct. The monthly means will then be, when the secular change is thus eliminated :—

Jan.	Feb.	March.	April.	May.	June.	July.	Aug.	Sept.	Oct.	Nov.	Dec.
25\cdot67,	25\cdot44,	25\cdot26,	25\cdot45,	25\cdot27,	27\cdot72,	26\cdot63,	25\cdot85,	24\cdot92,	26\cdot27,	23\cdot88,	24\cdot74.

These means are still affected by the varying torsion force of the suspension-thread,—the error due to this cause cannot be eliminated; it is probably greatest in the mean for June, in which month the suspension-thread broke. An examination of the variations of the plane of detorsion in several of the other months (see the notes to the Daily Observations of Magnetometers) will shew that the error from this cause is generally small; keeping this in view, if a curve be run freely through the projected means for the 12 months, there seems to be a minimum of westerly declination about March, and a maximum perhaps in July or August. Having an eye to the result for 1844, and also to the result for the horizontal and vertical components of intensity, I am inclined to believe that the *annual period of magnetic declination* will be found to consist of a *minimum at the vernal and a maximum at the autumnal equinox*.

The means for the four seasons are—

Spring.	Feb., March, and April, mean	25\cdot38
Summer.	May, June, and July, mean	26\cdot54
Autumn.	Aug., Sept., and Oct., mean	25\cdot68
Winter.	Jan., Nov., and Dec., mean	24\cdot76

These means indicate the maximum in Summer and the minimum in Winter; but there is little doubt that the mean for June is too high, and those for September, November, and December, too low.

After correcting the monthly means of the nine observations to the monthly means of twenty-four observations, the mean westerly declination for the year 1843 is found to be $25^{\circ} 22\cdot85$.

TABLE II.—Mean Variations of Westerly Declination, after Eliminating the Secular Change, with Reference to the Moon's Age, Declination, and Distance from the Earth, for 1843.

Moon's Age.	Variations of West Declination.	Moon's Age.	Variations of West Declination.	After Moon farthest North.	Variations of West Declination.	After Moon farthest North.	Variations of West Declination.	Before and after Perigee.	Variations of West Declination.	Before and after Apogee.	Variations of West Declination.
Day.	'	Day.	'	Day.	'	Day.	'	Day.	'	Day.	'
15	0.85	0	0.19	0	1.05	14	1.28	7	0.72	7	0.88
16	0.94	1	0.30	1	0.80	15	0.64	6	0.00	6	0.93
17	1.07	2	0.00	2	1.40	16	0.84	5	1.02	5	0.54
18	1.04	3	0.43	3	0.69	17	1.16	4	0.40	4	0.18
19	1.10	4	0.71	4	0.96	18	0.47	3	0.23	3	0.19
20	0.89	5	0.96	5	0.66	19	0.25	2	0.62	2	0.08
21	0.35	6	0.88	6	0.53	20	0.00	1	0.35	1	0.03
22	0.32	7	0.71	7	0.89	21	0.13	P	0.40	A	0.01
23	0.11	8	0.71	8	1.02	22	0.40	1	0.60	1	0.40
24	0.25	9	0.14	9	0.99	23	0.76	2	0.64	2	0.24
25	0.66	10	0.32	10	0.40	24	0.30	3	0.66	3	0.42
26	0.84	11	0.96	11	0.64	25	1.19	4	0.85	4	1.23
27	0.06	12	0.92	12	1.42	26	1.11	5	0.82	5	0.89
28	0.30	13	1.04	13	1.03	27	1.24	6	0.75	6	0.67
29	0.32	14	0.73					7	0.60	7	0.80

The above Table was formed from the daily means in Table I. in the following manner :—The mean westerly declination on the 12 days, between January 15. 1843 and January 4. 1844, on which the moon's age was 15 days, were summed together, similarly for 16 days old, 17 days old, . . . the means of these sums were then taken, and the differences from the lowest mean are given in the above Table. In these summations the approximate means for Sundays were used, as it was conceived that the want of any means on these days would affect the results more seriously than the use of the approximations. As in some lunations the 29th day was wanting, the mean of the declinations on the 28 day and the day of new moon was summed instead.

For the variations of westerly declination with reference to the moon's meridian altitude, the day on which the moon was farthest north was numbered 0, and the days after this were numbered up to 26 or 27, the day before the moon again attained its greatest north declination; if there were only 26 days the mean of the declinations on the 26th and 0th day was substituted for the mean on the 27th day; the mean westerly declination was then obtained for all the days of the same number from January 13. 1843 till January 3. 1844, each mean being the mean of the westerly declinations on 13 days; the differences from the lowest were then taken, and are inserted above.

For the variation of westerly declination with respect to the moon's distance from the earth, it will be seen in the foregoing Table that the days before and after apogee and perigee are numbered from 1 up to 7; in some instances there are only 5 days before apogee and 5 days after perigee, or before perigee and after apogee; in these cases, for example, the 5th day before apogee has been numbered also as the 6th and 7th after perigee, and the 5th after perigee as the 6th and 7th before apogee; when there are 11 days between apogee and perigee, or perigee and apogee, the 6th is counted as the 6th and 7th before and after; when there are 12 days between, the 6th before apogee is counted as the 7th after perigee, and *vice versa*; when there are 13 days, the 7th day is counted as the 7th before and after, and when there are 15 or 16 days, the mean of the declinations for the 7th and 8th days is used as the mean for the 7th. The mean westerly declinations for the days with similar numbers, between January 12. 1843 and January 5. 1844, were then obtained as in the previous cases, and the differences from the lowest mean are given in Table II.; each number is the mean of 13. It would have simplified the summations, and this statement of them, to have rejected the means on the 8th, 7th, and 6th days (of themselves they would have been useless), but it seemed better to combine them with other means nearly similarly related to the distance of the moon than to throw them away.

After the summations for each of the above cases had been performed, and the means obtained, the secular change was eliminated at the rate of 0.0165 *per diem*.

The above statement will apply to the similar summations for the horizontal and vertical components of magnetic force.

VARIATIONS OF WESTERLY DECLINATION WITH REFERENCE TO THE RELATIVE POSITIONS OF THE SUN, MOON, AND EARTH, AS INDICATED BY THE MOON'S AGE.

A glance at the numbers in the first portion, Table II., shews, with some irregularities, which may be expected where the effects of irregular causes have not been eliminated, the same result as is deduced from the means for the following groups, namely, *that there is a maximum of westerly declination when the Sun and Moon are in opposition, and a minimum when they are in conjunction.*

Means of Groups.

19 days to 26 days,	8 days including the Third Quarter, mean	0.56
27 3 ...	7 the New Moon,	0.23
4 11 ...	8 the First Quarter,	0.67
12 18 ...	7 the Full Moon,	0.94

The westerly declination also has its mean value at the quadratures.

VARIATIONS OF WESTERLY DECLINATION WITH REFERENCE TO THE MOON'S DECLINATION.

The second portion of Table II. gives the following :—

Means of Groups.

4 days to 10 days,	7 days, including the Moon's passage of the Equator southwards, mean	0.78
11 17	greatest south declination,	1.00
18 24	passage of the Equator northwards,	0.33
25 3	greatest north declination,	1.07

From these, and from the partial means, it appears *that a maximum of westerly declination occurs both when the moon has its greatest north and greatest south declination, the maxima being nearly equal, and that minima occur about the time at which the moon crosses the equator, the principal minimum occurring when the moon is moving northwards.*

VARIATIONS OF WESTERLY DECLINATION WITH REFERENCE TO THE MOON'S DISTANCE FROM THE EARTH.

The third portion of Table II. gives the following :—

Means of Groups.

Perigee, 3 days before it and 3 days after it, mean	0.50
8 days about the mean distance, the Moon moving from the Earth, mean	0.69
Apogee, 3 days before it and 3 days after it, mean	0.20
8 days about the mean distance, the Moon approaching the Earth, mean	0.72

As the periods of Apogee and Perigee in 1843 are nearly the same as of the moon's passage of the equator, the results for the mean distance will be similar to those for the greatest north and south declination. It will require two or three year's results to determine to which period the changes are referable. As it is my *belief* that the apparent variations of the magnetical elements with the moon's distance are really due to variations of declination, I have not in this, or in succeeding cases, pointed out the conclusions to which the means lead.

TABLE III.—Mean Westerly Declination at the Observation Hours for each Month in 1843.

Month.	18.	20.	22.	23.	0.	2.	4.	6.	8.	10.
1843.	25°	25°	25°	25°	25°	25°	25°	25°	25°	25°
January	24.29	24.96	24.58		27.50	28.95	27.13	25.85	25.04	24.03
February	23.94	24.21	24.71		27.84	29.41	27.65	25.92	23.97	21.06
March	22.65	23.14	22.83		27.15	29.78	28.52	25.14	24.05	21.85
April	21.36	20.67	22.78		27.78	31.19	28.37	24.06	22.32	21.45
May	20.76	19.79	21.95		27.05	29.72	27.05	24.55	23.63	22.54
June	21.69	20.56	23.39		28.91	31.70	29.52	26.15	25.34	25.00
July	20.44	20.09	22.17		27.17	30.04	27.71	25.15	23.48	21.42
August	19.80	18.48	21.77		26.89	29.31	26.15	22.47	21.15	21.26
September	19.48	19.55	20.74		25.82	27.51	24.94	21.29	18.98	16.76
October	20.97	21.46	21.84		26.37	26.67	24.14	21.90	20.66	18.77
November	18.55	18.80	18.97	20.37	22.02	22.06	20.99	19.76	17.93	17.43
December	19.00	19.02	19.56	20.53	21.57	22.42	21.05	19.73	17.27	16.69
Mean	21.08	20.89	22.11		26.34	28.23	26.10	23.50	21.98	20.69

The above Table is intended chiefly as a key for comparing the tabular observations.

The mean at 18^h in January is rendered comparable with the means at the other hours thus: the daily means from January 9 to 14, being the means of 8 daily observations, were corrected by -0.14 , obtained, as for Table I., in order to reduce them to the mean of 9 daily observations, then

Mean Westerly Declination, January 9—31,	= 25.83
..... January 16—31,	= 26.25
Difference,	= 0.42

The mean for 18^h, deduced from the observations January 16—31, was therefore corrected by -0.42 , in order to reduce it to the mean from January 9—31 as for the other hours.

SECULAR CHANGE.

By comparing the means at 20^h, 23^h, 2^h, and 5^h, the observation hours in 1842 (Table I., p. 136, 1842), with the means at 20^h, $\frac{22^h + 0^h}{2}$, 2^h and $\frac{4^h + 6^h}{2}$ for 1843, we obtain the following results for the yearly retrogression of westerly declination:—

	20 ^h	23 ^h	2 ^h	5 ^h
1842,	26.61	29.80	33.80	30.40
1843,	20.89	24.22	28.23	24.80
Difference,	5.72	5.58	5.57	5.60
Mean, 5.62.			

TABLE IV.—Diurnal Variation of Westerly Declination for each Month in 1843.

Period.	18 ^h .	20 ^h .	22 ^h .	23 ^h .	0 ^h .	2 ^h .	4 ^h .	6 ^h .	8 ^h .	10 ^h .	Range.
January	0.26	0.93	0.55		3.47	4.92	3.10	1.82	1.01	0.00	4.92
February	2.88	3.15	3.65		6.78	8.35	6.59	4.86	2.91	0.00	8.35
March	0.80	1.29	0.98		5.30	7.93	6.67	3.29	2.20	0.00	7.93
April	0.69	0.00	2.11		7.11	10.52	7.70	3.39	1.65	0.78	10.52
May	0.97	0.00	2.16		7.26	9.93	7.26	4.76	3.84	2.75	9.93
June	1.13	0.00	2.83		8.35	11.14	8.96	5.59	4.78	4.44	11.14
July	0.35	0.00	2.08		7.08	9.95	7.62	5.06	3.39	1.33	9.95
August	1.32	0.00	3.29		8.41	10.83	7.67	3.99	2.67	2.78	10.83
September	2.72	2.79	3.98		9.06	10.75	8.18	4.53	2.22	0.00	10.75
October	2.20	2.69	3.07		7.60	7.90	5.37	3.13	1.89	0.00	7.90
November	1.12	1.37	1.54	2.94	4.59	4.63	3.56	2.33	0.50	0.00	4.63
December	2.31	2.33	2.87	3.84	4.88	5.73	4.36	3.04	0.58	0.00	5.73
Spring	1.20	1.22	1.99		6.14	8.67	6.73	3.59	1.99	0.00	8.67
Summer	0.82	0.00	2.36		7.56	10.34	7.95	5.14	4.00	2.84	10.34
Autumn	1.15	0.90	2.52		7.43	8.90	6.14	2.95	1.33	0.00	8.90
Winter	1.23	1.54	1.65		4.31	5.09	3.67	2.40	0.70	0.00	5.09
The Year	0.39	0.20	1.42		5.64	7.54	5.41	2.80	1.29	0.00	7.54

Table IV. has been obtained from Table III. in subtracting the lowest mean in each month from all the other means. Spring in the above Table consists of the months of February, March, and April.

DIURNAL VARIATION OF DECLINATION.

The least westerly declination occurs in the first three and last four months of the year, at or after 9^h 10^m P.M. Makerstoun mean time; in the remaining five months at 7^h 10^m A.M. Mak. The greatest westerly declination occurs in each month at 1^h 10^m P.M., but in the winter months the maximum probably occurs before this time. The westerly declination increases with more rapidity to the maximum at 1^h 10^m P.M. than it diminishes after it, and in nine months the rapidity of diminution is less after 5^h 10^m P.M. than before it. In the winter months, the westerly declination does not begin to increase rapidly till 9^h 10^m A.M., whereas in summer, it does so at 7^h 10^m A.M. While this fact seems to shew some relation to *sunrise*, there is no corresponding one to *sunset*, but rather the reverse; for in winter the westerly declination diminishes with nearly equal rapidity from the maximum at 1^h 10^m P.M. till 9^h 10^m P.M., whereas in summer, on the whole, the rate of diminution seems to receive a check about 5^h 10^m P.M.

The minimum of westerly declination occurs in spring, autumn, and winter at or after 9^h 10^m P.M.; in spring and autumn a secondary minimum also occurs about 6^h 10^m A.M. In summer the principal minimum occurs at 7^h 10^m A.M. The principal maximum occurs about 0^h 40^m P.M. in winter, and about 1^h 10^m P.M. in summer.

In the mean for the year

The maximum of westerly declination occurs about 1^h 0^m P.M. Makerstoun mean time.
 The minimum after 9 10 P.M.
 A minimum about 7 0 A.M.

The exact periods of the principal minimum, and of the secondary maximum, cannot be determined from these observations; they are found, however, from the Term-day Observations in the years 1842 and 1843. The following Table contains the results of the summations of the observations at 0^m on 11 Term-days of 1842 (January Term-day being rejected), and on 11 Term-days of 1843 (June Term-day being rejected).

TABLE V.—Diurnal Variation of Westerly Declination deduced from the Observations at 0^m on 11 Term-days in 1842, and also on 11 Term-days in 1843.

Gött. M. T.	1842.	1843.	Mean.	Gött. M. T.	1842.	1843.	Mean.	Gött. M. T.	1842.	1843.	Mean.
H. 10	0.00	0.16	0.08	H. 18	3.86	0.92	2.39	H. 2	11.13	7.58	9.35
11	1.87	0.45	1.16	19	3.69	0.91	2.30	3	10.05	6.78	8.41
12	3.12	0.05	1.58	20	3.31	0.00	1.65	4	8.17	5.52	6.84
13	4.59	1.25	2.92	21	4.65	0.62	2.63	5	7.64	4.07	5.85
14	3.89	0.06	1.97	22	5.75	1.66	3.70	6	6.02	3.15	4.58
15	3.84	2.00	2.92	23	7.26	3.40	5.33	7	5.05	1.99	3.52
16	3.64	2.23	2.93	0	9.69	5.71	7.70	8	4.43	1.48	2.95
17	4.19	1.13	2.66	1	11.50	7.42	9.46	9	3.97	1.09	2.53

Both years give nearly the same result; the observations at 10^h and 11^h Gött. M. T. are affected by disturbances in 1842. The mean shews:—

The maximum of westerly declination, about 0^h 40^m P.M. Makerstoun mean time.
 The minimum 10^h 10^m P.M.
 A secondary maximum 2^h 10^m A.M.
 A secondary minimum..... 7^h 10^m A.M.

RANGES OF THE MONTHLY MEANS OF THE DIURNAL VARIATION.

The ranges given in the last column of Table IV. are probably very near the truth, for though the minimum takes place after 10^h Gött. M.T., the diminution after that time must be small. The range increases considerably from January to April, and diminishes as much from September to December, but there is little difference in the ranges of the six months from April to September. The range of the means for the summer quarter is twice as great as the range of the means for the winter quarter, the former being 10'34, and the latter 5'09.

TABLE VI.—Diurnal Range of Magnetic Declination for each Civil Day, as deduced from the Nine Daily Observations, with the Mean for each Week and for each Month in 1843.

Civil Day.	January.	February.	March.	April.	May.	June.	July.	August.	September.	October.	November.	December.
1	[.....]	3.19	3.60	11.05	10.54	15.41	17.36	11.00	14.29	[9.35]	9.22	11.80
2	4.84	4.05	5.29	[12.78]	14.88	[13.93]	11.95	21.77	6.91	8.17	9.37
3	7.27	3.47	4.50	15.84	6.83	17.63	15.03	12.62	[14.75]	12.79	12.74	[6.71]
4	2.56	3.54	9.77	12.18	12.23	[12.75]	8.97	19.10	13.28	9.00	5.65	4.06
5	2.38	[12.79]	[10.38]	19.49	9.75	7.75	7.84	7.16	11.89	21.48	[7.94]	5.25
6	3.60	49.03	15.14	33.38	25.50	8.80	7.63	[13.30]	13.29	9.77	9.29	6.43
7	3.94	9.70	21.85	13.78	[12.85]	12.05	8.17	9.46	9.64	7.06	4.65	5.38
8	[4.32]	6.93	5.72	14.37	7.87	7.73	10.56	13.47	11.02	[9.44]	7.17	16.91
9	6.06	8.77	5.35	[15.70]	9.18	9.04	[9.81]	18.02	16.44	8.07	5.87	14.54
10	5.31	7.86	5.10	7.97	12.55	16.20	14.32	10.01	[12.13]	3.55	3.26	[12.78]
11	4.66	5.81	12.07	13.36	6.62	[10.77]	10.25	12.96	13.17	6.71	5.42	17.39
12	4.41	[10.72]	[7.59]	11.33	12.68	8.64	7.92	15.51	8.75	8.61	[6.55]	13.09
13	5.02	22.54	9.42	10.22	6.36	13.72	12.35	[11.61]	13.74	9.63	9.50	9.37
14	4.39	11.18	7.26	11.29	[9.17]	9.31	9.55	13.03	10.34	10.98	7.78	6.26
15	[5.59]	8.18	6.34	13.43	13.27	9.39	11.70	10.98	9.01	[10.41]	7.50	3.09
16	9.42	15.25	8.67	[10.87]	8.85	9.25	[10.77]	7.19	8.07	14.97	6.02	2.97
17	4.87	4.57	7.82	11.36	7.23	9.43	10.26	10.56	[13.06]	6.91	4.64	[4.52]
18	5.45	5.69	21.56	8.38	9.87	[9.70]	10.87	8.27	21.83	11.39	4.00	5.13
19	6.51	[7.23]	[12.47]	10.55	9.32	7.00	9.91	11.77	15.92	8.84	[4.70]	3.98
20	4.85	4.78	14.19	10.22	8.17	11.70	8.98	[10.83]	13.18	7.97	3.09	5.67
21	5.81	6.59	7.80	10.38	[9.51]	11.45	10.00	10.28	17.99	4.27	6.67	12.33
22	[6.75]	6.48	14.80	5.30	7.31	11.61	14.27	12.86	[6.96]	3.79	3.19
23	9.25	6.19	8.69	[9.26]	9.35	[16.04]	9.85	11.03	5.92	5.45	3.36
24	6.86	23.44	8.29	9.82	13.05	13.98	32.85	8.77	[12.72]	8.74	4.87	[5.84]
25	7.22	12.30	8.61	10.05	15.02	[14.34]	17.92	10.76	9.89	6.00	2.82	4.61
26	6.32	[9.68]	[11.47]	9.80	16.33	16.49	14.88	11.83	15.57	25.14	[4.04]	5.29
27	4.98	3.81	8.36	12.13	13.57	13.79	12.95	[11.09]	8.98	6.06	2.68	6.27
28	11.85	8.74	19.12	12.02	[13.25]	13.12	11.84	10.17	11.04	5.18	4.10	8.18
29	[5.93]	25.78	11.74	15.17	8.76	14.86	12.87	9.30	[11.77]	4.31	8.49
30	5.85	9.22	[10.65]	9.16	25.60	[12.29]	12.12	7.07	9.60	3.38	5.99
31	3.40	8.92	10.27	11.14	13.99	15.43	[7.92]
Mean	5.66	10.09	10.12	12.38	11.00	12.13	12.30	11.78	12.67	9.65	5.85	7.63

MONTHLY MEANS OF THE DIURNAL RANGES.

The means of the diurnal ranges for January, November, and December, do not differ much from each other, but they differ considerably from the means for the remaining nine months, which differ little from each other. The means for the four seasons are:—

Winter; January, November, and December, mean of diurnal ranges,	. = 6.38
Spring; February, March, and April, = 10.86
Summer; May, June, and July, = 11.81
Autumn; August, September, and October,.....	. = 11.37
The Year, = 10.10

The quantities in Table VI. shew that the monthly means are much affected by irregular disturbing causes, and that if some of the larger diurnal ranges were removed, the monthly means would differ little from the ranges of the monthly means of the diurnal variations. It is obvious that the means of the diurnal ranges only differ from the diurnal ranges of the means in that the minimum or maximum of certain days does not oc-

cur at the same hour as the minimum or maximum of the monthly mean; as these departures from the mean are probably due to irregular disturbing causes, the following differences may be taken as some measure of these disturbances in the different months of the year :—

Monthly Means of Diurnal Ranges *minus* the Ranges of the Monthly Means of the Diurnal Variation :—

Jan.	Feb.	Mar.	April.	May.	June.	July.	Aug.	Sept.	Oct.	Nov.	Dec.
0·74	1·74	2·19	1·86	1·07	0·99	2·35	0·95	1·92	1·75	1·22	1·90

The difference is a minimum in January, it increases to a maximum in March, diminishes to a minimum in June; and, if we except the sudden increase in July, it again becomes a maximum in September. The means of the differences for the four seasons are :—

Winter; January, November, December, mean	1·29
Spring; February, March, April,	1·93
Summer; May, June, July,	1·47
Autumn; August, September, October,	1·54

From this we are perhaps entitled to conclude, *that a certain class of disturbances have their greatest effect at the equinoxes, and their least effect at the solstices.*

Those disturbances which increase the diurnal range of the mean are evidently not included in this result.

TABLE VII.—Means of the Diurnal Ranges of Magnetic Declination with reference to the Moon's Age and Declination for 1843.

Moon's Age.	Mean Range.	Moon's Age.	Mean Range.	After Moon farthest North.	Mean Range.	After Moon farthest North.	Mean Range.
Day.	'	Day.	'	Day.	'	Day.	'
15	9·79	0	9·92	0	9·63	14	10·99
16	10·17	1	8·55	1	13·01	15	8·67
17	10·95	2	8·25	2	12·96	16	8·71
18	9·03	3	12·15	3	12·71	17	9·20
19	9·70	4	9·60	4	13·61	18	8·44
20	9·23	5	10·28	5	11·11	19	9·30
21	9·57	6	12·31	6	10·37	20	9·98
22	8·95	7	15·52	7	8·90	21	9·37
23	9·22	8	11·40	8	8·35	22	9·91
24	9·25	9	8·45	9	9·03	23	10·12
25	11·15	10	10·74	10	9·42	24	13·21
26	10·57	11	9·80	11	9·64	25	10·98
27	11·89	12	11·16	12	9·35	26	9·70
28	11·21	13	9·97	13	10·92	27	9·88
29	10·56	14	9·23				

This Table has been formed from Table VI. in the manner already described, Table II.

VARIATIONS OF THE DIURNAL RANGES OF MAGNETIC DECLINATION WITH REFERENCE TO THE RELATIVE POSITIONS OF THE SUN, MOON, AND EARTH, AS INDICATED BY THE MOON'S AGE.

The partial means are very irregular, their general aspect when projected is that of a maximum near the time of new moon, and a minimum near the time of full moon; in groups, the results are as follow:—

19 days to 26 days,	8 days including the Third Quarter, mean	9·70
27 3 ...	7 New Moon,	10·41
4 11 ...	8 First Quarter,	11·01
12 18 ...	7 Full Moon,	10·04

From these means the maximum would appear to occur in the First Quarter, and the minimum in the Third Quarter.

VARIATIONS OF THE DIURNAL RANGE OF THE MAGNETIC DECLINATION WITH REFERENCE TO THE MOON'S DECLINATION.

In the partial means there is an appearance of a secondary maximum at the moon's greatest south declination, but this disappears in the following means:—

4 days to 10 days, including the moon's passage of the Equator southwards, mean	10·11
11 17 greatest south declination, 9·64
18 24 passage of the Equator northwards, 10·05
25 3 greatest north declination, 11·27

Or, the diurnal range of the magnetic declination is a maximum when the moon has its greatest north declination, and it is a minimum at the time of the moon's greatest south declination.

HORIZONTAL COMPONENT OF MAGNETIC FORCE.

TABLE VIII.—Mean Values of the Variations of the Horizontal Component of Magnetic Force, the whole Horizontal Component being Unity, for each Civil Day, as deduced from the Nine Daily Observations, for each Week, and for each Month, in the Year 1843.

Civil Day.	January.	February.	March.	April.	May.	June.	July.	August.	September.	October.	November.	December.
	0·00	0·00	0·00	0·00	0·00	0·00	0·00	0·00	0·00	0·00	0·00	0·00
1	[.....]	1645	1808	1804	2068	2722	2288	2766	3093	[2982]	3572	3695
2	1353	1780	1952	[1540]	2033	3097	[2722]	2537	3200	2617	3851	3695
3	1531	1761	1973	1533	2418	2569	2765	3476	[2904]	2862	3204	[3911]
4	1589	2386	1991	1420	2455	[2791]	2508	3025	2590	3342	3919	4059
5	1649	[1928]	[1670]	1613	2323	2566	2499	2638	2449	2863	[3487]	3969
6	1766	2003	1736	0848	1807	2722	2443	[2745]	2949	2728	3600	3926
7	1955	1820	1114	1097	[1995]	3067	2814	2870	2638	2899	3294	4318
8	[1853]	1815	1255	1729	1037	2265	2360	2478	2759	[2923]	3056	3688
9	2148	1379	1636	[1320]	1664	2432	[2557]	1984	2752	2833	4670
10	1863	1718	1603	1185	2685	3352	2675	2679	[2794]	2977	[4122]
11	1741	1574	1708	1276	2197	[2622]	2630	2626	2771	3241	3201	4059
12	1695	[1570]	[1456]	1784	2087	2679	2425	2754	2958	3321	[3307]	3943
13	1809	1778	1079	1620	2225	2293	2775	[2644]	2886	3353	3408	4055
14	1695	1247	1220	1594	[2364]	2711	2667	2470	3342	3337	3340	4113
15	[1894]	1726	1493	1365	2900	2511	2944	2524	3289	[3291]	3343	4265
16	2358	1907	1029	[1693]	2270	2415	[2762]	2812	3398	3655	3410	4420
17	1951	1941	1254	1871	2504	2598	2701	2944	[3249]	2747	4005	[4326]
18	1855	1835	1667	1919	2519	[2735]	2652	2827	3613	3335	3816	4238

TABLE VIII.—Continued.

Civil Day.	January.	February.	March.	April.	May.	June.	July.	August.	September.	October.	November.	December.
19	0 ⁰⁰ 1638	0 ⁰⁰ [1817]	0 ⁰⁰ [1509]	0 ⁰⁰ 1790	0 ⁰⁰ 2567	0 ⁰⁰ 2903	0 ⁰⁰ 2832	0 ⁰⁰ 2617	0 ⁰⁰ 2731	0 ⁰⁰ 3678	0 ⁰⁰ [3972]	0 ⁰⁰ 4566
20	1760	1716	1440	1850	2453	3189	2588	[2890]	3119	2885	4236	4355
21	1926	1739	1564	1838	[2653]	2797	3033	3008	2818	3505	4218	4473
22	[1703]	1764	2099	1748	3003	2929	2805	3086	3141	[3370]	4144	4564
23	1321	1906	1760	[1942]	2734	2552	[2836]	2856	3287	3482	3807	4589
24	1940	1467	1278	2060	2643	2857	3829	2874	[2961]	3218.	4531	[4500]
25	1637	1577	1732	2057	2718	[2751]	2911	2712.	2993	3451	4459	4672
26	1524	[1744]	[1655]	2099	2649	2823	1852	2400	2619	2866	[4213]	4472
27	2033	1856	1576	2692	2648	2343	[2854]	2908	3093	4478	4230
28	1434	1855	1825	[2830]	2693	2302	2935	2672	3458	3992	4092
29	[1635]		1760	2115	3380	3152	2731	3100	3093	[3232]	4013	4151
30	1609		1160	[2158]	2782	3120	[2547]	3106	3308	2875	4076	4122
31	1566		1708		2758		2604	3146		3526		[4292]
Mean	1744	1758	1571	1662	2428	2756	2653	2787	2976	3160	3790	4207

Table VIII. was formed in the following manner :—the means of the bifilar magnetometer scale readings, corrected for temperature, for each civil day, were first obtained, and these means were reduced to parts of the horizontal component by the following formulæ :—

$$\begin{aligned} \text{Jan. 1—April 26. } f &= (n - 530) 0.0001021 + 0.001000 \\ \text{April 29—May 6. } f &= (n - 488) 0.0000986 + 0.001000 \\ \text{May 8—Nov. 8. } f &= (n - 485) 0.0000986 + 0.001000 \\ \text{Nov. 11—Dec. 31. } f &= (n - 485) 0.0001064 + 0.001000 - 0.000008 \end{aligned}$$

where f is the quantity in the previous Table, n the mean scale reading corrected for temperature.

The Bifilar magnetometer was twice adjusted in 1843 (see Introduction, No. 38). As the means for the three days immediately preceding the adjustment on April 27–28 were nearly equal to each other, and the means for the three days succeeding the adjustment were also nearly equal to each other, it was assumed that the mean force, n , for the three days succeeding the adjustment was equal to that, n' , for the three days preceding it. 530 having been taken as a convenient zero for the means before the adjustments, z the zero for the means after the adjustment was obtained from the formula

$$(n - 530) 0.0001021 = (n' - z) 0.0000986$$

whence $z = 488$.

On May 6 the torsion circle was turned, and was not returned to its previous position, producing a difference of about three scale divisions, the zero after May 6 is therefore 485.

On the adjustment, Nov. 9–10, the same process was adopted as for that of April 27–28, which gave the zero nearly as before, 484.93; 0.001000 has been added to each mean in order to render them all positive.

The means of the four daily observations in the first week of January were corrected by -0.000025 , and the means of the eight daily observations in the second week by $+0.000016$, corrections to the mean of nine observations obtained by comparisons of the observations in 1844.

The factors used for the above and following Tables in converting the scale divisions into parts of the whole horizontal component, are those given in the Postscript to the Introduction.

ANNUAL PERIOD OF THE HORIZONTAL COMPONENT OF MAGNETIC FORCE.

Differences of the monthly means deduced from the observations in 1844, at the nine hours of 18, 20, . . . 10, from those deduced from the 24 hourly observations made on each day, excepting Sundays, in that year.

24 observations *minus* 9 observations.

	Jan.	Feb.	March.	April.	May.	June.	July.	Aug.	Sept.	Oct.	Nov.	Dec.
0.0000	-36	-61	-69	+24	-24	+13	+29	-34	+68	+46	-06	-28

These quantities being applied as corrections to the monthly means, foot of Table VIII., we obtain the following :—

	Jan.	Feb.	March.	April.	May.	June.	July.	Aug.	Sept.	Oct.	Nov.	Dec.
0.00	1708	1697	1502	1686	2404	2769	2682	2753	3044	3206	3784	4179

From these it appears that the horizontal component diminishes from January to March, increases from March to June, diminishes again slightly from June to between July and August, and then increases again till December; the whole range being 0.002677, and the increase of force from January to December being 0.002471. The annual period can only be rendered distinct when this secular change is eliminated. It has been found by a comparison of the monthly means of 1843 with those of 1842 and of 1844, that the mean annual change during the 12 months of 1843 is 0.002826. When proportional parts of this are subtracted from the means after January, we have—

	Jan.	Feb.	March.	April.	May.	June.	July.	Aug.	Sept.	Oct.	Nov.	Dec.
0.00	1708	1462	1031	0980	1462	1592	1269	1105	1160	1087	1429	1589

We have here a well marked *annual period*, consisting of *maxima near the solstices, and minima near the equinoxes*. The maximum is rather greater in the winter than in summer, but the difference is less than the effect of half a degree Fahrenheit on the bifilar magnet.

The range of the annual period is 0.000723, or about half the mean diurnal range for the year.

It may be desirable to examine the annual period for the year 1842 in a similar manner. If we reduce the monthly means of four observations, Table IX., Abstracts for 1841-2, to parts of force by the formula

$$f = (n - 530) 0.0001021 + 0.003000$$

where n is the mean in scale divisions in the Table referred to, we obtain the following values of f , which may be rendered comparable with the means, Table VIII., by subtracting 0.002000. The second line below contains the corrections for each month of the 4 observations to the 24 as deduced from the observations for 1844, and the third line contains the corrected means.

	Jan.	Feb.	March.	April.	May.	June.	July.	Aug.	Sept.	Oct.	Nov.	Dec.
0.00	0960	0994	1188	0840	1646	1803	1743	1836	2016	2488	2772	3270
0.00	-0057	-0045	-0003	+0294	+0245	+0309	+0352	+0390	+0318	+0187	+0068	-0020
0.00	0903	0949	1185	1134	1891	2112	2095	2226	2334	2675	2840	3250

If the secular change be assumed the same for 1842 as for 1843, and if this be eliminated, we have—

	Jan.	Feb.	March.	April.	May.	June.	July.	Aug.	Sept.	Oct.	Nov.	Dec.
0.000	903	714	714	428	949	935	682	578	450	556	485	660

These means shew the same law as the means for 1843, with more irregularity, it is true, but this may be accounted for by the fewness of the observations, and the possible inaccuracy of the corrections.

TABLE IX.—Mean Variations of the Horizontal Component of Magnetic Force, after eliminating the Secular Change, with reference to the Moon's Age, Declination, and Distance from the Earth, for 1843.

Moon's Age.	Variations of Horizontal Component.	Moon's Age.	Variations of Horizontal Component.	After Moon farthest North.	Variations of Horizontal Component.	After Moon farthest North.	Variations of Horizontal Component.	Before and after Perigee.	Variations of Horizontal Component.	Before and after Apogee.	Variations of Horizontal Component.
Day.	0.000	Day.	0.000	Day.	0.000	Day.	0.000	Day.	0.000	Day.	0.000
15	000	0	288	0	263	14	224	7	328	7	145
16	199	1	213	1	211	15	182	6	256	6	061
17	117	2	322	2	292	16	103	5	249	5	232
18	245	3	260	3	246	17	119	4	000	4	173
19	169	4	288	4	013	18	204	3	091	3	225
20	246	5	311	5	000	19	234	2	239	2	191
21	299	6	242	6	034	20	274	1	192	1	242
22	300	7	115	7	126	21	138	P	197	A	144
23	196	8	178	8	243	22	228	1	242	1	320
24	328	9	083	9	188	23	191	2	251	2	256
25	251	10	038	10	089	24	182	3	219	3	253
26	313	11	090	11	329	25	224	4	263	4	238
27	350	12	125	12	223	26	151	5	311	5	250
28	359	13	043	13	247	27	223	6	338	6	364
29	229	14	173					7	222	7	342

Table IX. was formed from Table VIII. in the manner indicated for the magnetic declination, Table II.

VARIATIONS OF THE HORIZONTAL COMPONENT OF MAGNETIC FORCE, WITH REFERENCE TO THE RELATIVE POSITIONS OF THE SUN, MOON, AND EARTH, AS INDICATED BY THE MOON'S AGE.

The partial means in the first portion of Table IX. shew distinctly what is more distinctly evident in the following means, namely, the maximum about the period of new moon, and the minimum at the period of full moon :—

Means of Groups.

14 days to 16 days, Full Moon,	0.000124	29 days to 1 day, New Moon,	0.000243
17 20 ...	0.000194	2 5 ...	0.000295
21 24 ...	0.000278	6 9 ...	0.000154
25 28 ...	0.000318	10 13 ...	0.000074

It should be remarked that there is a secondary minimum shewn in these means at the time of new moon ; this would not have been seen so distinctly, or at all, had larger groups been taken. As this minimum is also shewn, and nearly to the same extent in the mean for 1844,* it may be allowable to conclude, that *the principal minimum of the horizontal component occurs at the period of full moon ; a secondary, and not very decided minimum, at the period of new moon ; and maxima, nearly equal, immediately before and after the period of new moon.*

* Transactions of the Royal Society of Edinburgh, Vol. XVI., Plate IV.

VARIATIONS OF THE HORIZONTAL COMPONENT OF MAGNETIC FORCE, WITH REFERENCE TO THE MOON'S DECLINATION.

Means of Groups.

27 days to 1 day, Moon farthest North, 0.000232	13 days to 15 days, Moon farthest South, 0.000218
2 5 ... 0.000138	16 19 ... 0.000165
6 8 ... 0.000134	20 22 ... 0.000213
9 12 ... 0.000207	23 26 ... 0.000187

From these means we may conclude that *there are maxima when the moon has its greatest north and south declination, and minima when its declination is zero*; the principal minimum occurs when the moon is on the equator moving southwards.

VARIATIONS OF THE HORIZONTAL COMPONENT OF MAGNETIC FORCE, WITH REFERENCE TO THE MOON'S DISTANCE FROM THE EARTH.

Means of Groups.

6 days after Apogee to 6 days before Perigee, 0.000322	6 days after Perigee to 6 days before Apogee, 0.000191
5 days to 2 days before Perigee, . . . 0.000145	5 days to 2 days before Apogee, . . . 0.000295
1 day before to 1 day after Perigee, . . . 0.000210	1 day before to 1 day after Apogee, . . . 0.000235
2 days to 5 days after Perigee, . . . 0.000261	2 days to 5 days after Apogee, . . . 0.000240

TABLE X.—Means of the Bifilar Magnetometer Readings Corrected for Temperature, at the Observation Hours for each Month in 1843.

Month.	18 ^h .	20 ^h .	22 ^h .	23 ^h .	0 ^h .	2 ^h .	4 ^h .	6 ^h .	8 ^h .	10 ^h .
January	Sc. Div. 538.10	Sc. Div. 537.95	Sc. Div. 533.71	Sc. Div.	Sc. Div. 534.11	Sc. Div. 538.80	Sc. Div. 540.62	Sc. Div. 538.19	Sc. Div. 537.11	Sc. Div. 537.41
February	535.84	539.04	533.72		534.93	538.23	540.14	537.43	538.34	537.39
March	534.90	534.22	528.48		528.07	535.96	540.36	540.54	538.30	537.34
April	534.53	533.37	524.37		525.56	536.19	543.66	548.25	542.26	536.90
May	496.79	492.82	486.56		489.30	501.94	506.84	512.85	512.56	501.77
June	500.47	495.70	488.00		491.42	502.11	508.64	512.19	515.87	510.96
July	497.55	495.32	486.07		488.08	499.48	512.98	515.88	513.74	506.85
August	498.64	494.37	487.41		491.91	505.11	512.13	514.71	512.69	511.20
September	505.50	500.25	491.77		496.61	505.57	512.57	509.50	510.72	509.48
October	508.03	504.51	495.66		497.44	508.25	512.18	512.64	512.31	511.17
November	510.60	509.00	503.19	501.43	503.77	512.41	515.16	516.06	513.70	509.29
December	513.69	513.08	508.73	508.45	510.06	513.66	514.04	514.41	512.09	512.10
	518.08	518.14	514.01	513.52	513.64	514.38	516.53	514.82	514.48	512.97

Table X. is intended chiefly as a key for comparing the tabular observations. The cross lines indicate breaks in the series from new adjustments, which will be found alluded to after Table VIII.

The mean at 18^h in January is rendered comparable with the means at the other hours thus; the daily means from January 9–14, being the means of 8 daily observations, were corrected by +0.15 sc. div., obtained as for Table VIII., in order to reduce them to the mean of 9 daily observations, then,—

	Sc. Div.
Mean of Bifilar readings, January 9–31,	= 537.36
..... 16–31,	= 537.14
	<hr style="width: 10%; margin: 0 auto;"/>
Difference,	= 0.22

The mean for 18^h deduced from the observations January 16–31, was therefore corrected by +0.22, in order to reduce it to the mean from January 9 to 31, as for the other hours.

TABLE XI.—Diurnal Variations of the Horizontal Component of Magnetic Force in 1843, the whole Horizontal Component being Unity.

Periods.	18 ^h .	20 ^h .	22 ^h .	23 ^h .	0 ^h .	2 ^h .	4 ^h .	6 ^h .	8 ^h .	10 ^h .	Range.
Months.	0.00	0.00	0.00	0.00	0.00	0.00	0.00	0.00	0.00	0.00	0.00
January	0448	0433	0000		0041	0519	0705	0457	0347	0378	0705
February	0217	0543	0000		0124	0461	0655	0379	0472	0375	0655
March	0697	0628	0042		0000	0806	1255	1273	1045	0946	1273
April	1037	0919	0000		0122	1207	1969	2438	1827	1279	2438
May	1009	0617	0000		0270	1516	1999	2591	2563	1499	2591
June	1229	0759	0000		0337	1391	2034	2384	2747	2263	2747
July	1131	0912	0000		0198	1322	2653	2938	2727	2048	2938
August	1107	0686	0000		0443	1745	2437	2691	2492	2345	2691
September	1353	0836	0000		0477	1360	2050	1747	1867	1746	2050
October	1220	0872	0000		0175	1241	1629	1674	1641	1529	1674
November	0587	0495	0000	–0071	0117	0637	0745	0799	0555	0430	0799
December	0543	0550	0110	0058	0071	0150	0379	0196	0160	0000	0550
Quarters.											
Spring	0636	0683	0000		0068	0811	1279	1349	1101	0853	1349
Summer	1123	0763	0000		0268	1410	2229	2638	2679	1937	2679
Autumn	1227	0798	0000		0365	1449	2039	2037	2000	1873	2039
Winter	0489	0456	0000		0040	0399	0573	0447	0317	0233	0573
Half-Years.											
Winter	0593	0562	0000		0063	0610	0869	0771	0678	0584	0869
Summer	1144	0788	0000		0308	1423	2190	2465	2370	1863	2465
The Year	0868	0674	0000		0185	1016	1529	1617	1524	1223	1617

SECULAR CHANGE OF THE HORIZONTAL COMPONENT OF MAGNETIC FORCE.

The mean change of the horizontal component from 1842 to 1843 has been determined in the following manner.

By the means for the year 1844, it has been found that the mean of the observations at 22^h and 0^h, is greater than the mean at 23^h by 0.000162, and that the mean of the observations at 4^h and 6^h is greater than the mean at 5^h by 0.000027, whence from the last line of Table XI.,—

$$\begin{aligned} \text{Mean of 22}^h \text{ and 0}^h &= +0.000092, \text{ corrected to mean for 23}^h = -0.000070 \\ \text{Mean of 4}^h \text{ and 6}^h &= +0.001573, \text{ corrected to mean for 5}^h = +0.001546 \end{aligned}$$

The last line of Table XI. also gives the mean of the horizontal component for the year greater than the mean at 22^h by 0·000960, and, from Table VIII., the mean of the horizontal component for the year 1843 = 0·002624, whence—

Mean at 20 ^h less than the mean for the year by	0·000286, or = 0·002338
Mean at 23 ^h	0·001030, or = 0·001594
Mean at 2 ^h greater	0·000056, or = 0·002680
Mean at 5 ^h	0·000586, or = 0·003210

From Table IX., Abstracts for the Observations of 1842, we obtain the following means in scale divisions :—

1842. 20^h = 514·56, 23^h = 510·09, 2^h = 521·82, 5^h = 526·37.

Converting these means into parts of force by the first formula given after Table VIII., we obtain the following results :—

	20 ^h .	23 ^h	2 ^h .	5 ^h .
1842.	−0·000576,	−0·001033,	+0·000165,	+0·000629
1843.	+0·002338,	+0·001594,	+0·002680,	+0·003210
Secular Change.	+0·002914,	+0·002627,	+0·002515,	+0·002581
	Mean Secular Change, 1842 to 1843, = +0·002658			

DIURNAL VARIATION OF THE HORIZONTAL COMPONENT OF MAGNETIC FORCE.

The means of the nine observations in Table XI. indicate two maxima and two minima in the months of January, February, November, and December; only one maximum and one minimum is visible in the means for the remaining months. The means for the four seasons are types of the months which compose them.

The principal minimum occurs in each month, and in the mean for the year about 9^h A.M.

The principal maximum occurs at 3^h 10^m P.M. in winter, about 4^h 10^m P.M. in spring and autumn, at 6^h 10^m P.M. in summer, and at 5^h 10^m P.M. in the mean for the year.

A secondary maximum occurs in winter about 6^h A.M.

The principal maximum in December occurs at 6^h 10^m A.M., in all the other months the principal maximum occurs in the afternoon.

In order to determine the periods of the secondary maximum and minimum, the observations made at 0^m on the Term-days of 1842 and 1843 have been made use of. The observations in 1842 were corrected by the temperature coefficient obtained by the method of deflections, those of which the means are given in the following Table were farther corrected by the coefficient − 0·46 Sc. div., the difference between the temperature coefficient obtained from deflections and that deduced from comparisons of the daily observations. The means in the following Table are then deduced from the observations at 0^m in 1842 thus corrected, and the observations at 0^m in 1843, as corrected in this volume. The winter solstice includes the months of November, December, January, and February, 1842 and 1843; the equinoxes, March, April, September, and October, 1842 and 1843; and the summer solstice, May, June, July, and August, 1842 and 1843.

TABLE XII.—Diurnal Variation of the Horizontal Component of Magnetic Force deduced from the Observations at 0^m on the Term-days of 1842 and 1843, the whole Horizontal Component being Unity.

Hour.	Winter Solstice.	Equinoxes.	Summer Solstice.	1842.	1843.	Mean.	Hour.	Winter Solstice.	Equinoxes.	Summer Solstice.	1842.	1843.	Mean.
10	0505	2336	1547	1852	1045	1449	22	0169	0224	0005	0156	0080	0119
11	0430	1806	1729	1417	1198	1308	23	0042	0000	0000	0000	0000	0000
12	0349	1852	1814	1328	1320	1324	0	0000	0361	0337	0342	0095	0219
13	0614	0872	1649	1010	1051	1031	1	0250	0861	0686	0656	0514	0585
14	0445	1492	1425	1224	0989	1107	2	0531	1357	1420	1335	0842	1089
15	0614	1375	1174	1022	1058	1040	3	0731	1845	1520	1532	1170	1351
16	0558	0766	1242	0607	1075	0841	4	0755	1957	1881	1663	1370	1517
17	0486	1377	1190	0972	1035	1004	5	0757	1942	1996	1656	1446	1551
18	0741	1477	0784	0987	0986	0987	6	0724	1899	2197	1832	1352	1593
19	0818	1550	0482	0984	0887	0936	7	0522	1681	2466	1714	1370	1542
20	0655	1191	0324	0646	0772	0709	8	0636	1376	2224	1416	1380	1398
21	0517	0861	0234	0526	0520	0523	9	0556	1404	2140	1356	1349	1353

Besides the occurrence of some considerable disturbances, the number of observations seems too few to exhibit the secondary maximum and minimum well. The results for the principal maximum and minimum are the same as those deduced from Table XI. It may perhaps be added, as true for both, that the principal minimum occurs nearer noon in winter and summer than at the equinoxes.

The secondary minimum occurs near midnight in the mean for the months about the winter solstice; perhaps about the same time in the mean for the months about the equinoxes, but this part of the diurnal curve is very irregular from disturbances; the secondary minimum cannot be said to be at all visible in the mean for the months about the summer solstice, and it is very imperfectly shewn in the means for the year.

The secondary maximum occurs about 6 A.M. in the winter solstitial and equinoctial months, and perhaps earlier in the means for the year.

RANGES OF THE MONTHLY MEANS OF THE DIURNAL VARIATIONS OF THE HORIZONTAL COMPONENT OF MAGNETIC FORCE.

The quantities given in the last column of Table XI. are rather less than the true ranges, the minimum occurring near 23^h. The least diurnal range is that for December, and the greatest that for July. The range is nearly constant for the winter months, and also for the summer months, the most rapid increase occurring at the equinoxes; the following means will exhibit the rate of increase:—

	Jan. & Dec.	Feb. & Nov.	March & Oct.	April & Sept.	May & Aug.	June & July.
Ranges,	0·000627	0·000727	0·001473	0·002244	0·002641	0·002842
Differences,	0·000100	0·000746	0·000771	0·000397	0·000201	

The range of the monthly means is more than four times as great for the summer as for the winter months.

TABLE XIII.—Diurnal Ranges of the Horizontal Component of Magnetic Force for each Civil Day, as deduced from the 9 Daily Observations in 1843, with the Weekly and Monthly Means.

Civil Day.	January.	February.	March.	April.	May.	June.	July.	August.	September.	October.	November.	December.
1	0·0 [.....]	0·0 0067	0·0 0046	0·0 0214	0·0 0231	0·0 0322	0·0 0385	0·0 0266	0·0 0328	0·0 [0220]	0·0 0194	0·0 0116
2	0067	0045	0109	[0389]	0249	0308	[0344]	0230	0375	0206	0192	0215
3	0127	0092	0091	0190	0213	0207	0378	0461	[0294]	0175	0237	[0124]
4	0089	0070	0113	0215	0198	[0271]	0395	0696	0278	0204	0169	0067
5	0111	[0104]	[0172]	1265	0302	0285	0251	0319	0278	0261	[0162]	0110
6	0173	0162	0174	0515	0939	0229	0224	[0425]	0281	0212	0097	0154
7	0029	0172	0346	0207	[0447]	0272	0289	0287	0217	0240	0155	0097
8	[0138]	0085	0199	0391	0476	0278	0412	0255	0265	[0226]	0124	0259
9	0227	0088	0189	[0331]	0288	0224	[0330]	0528	0405	0239	0242
10	0104	0092	0139	0197	0482	0302	0442	0427	[0252]	0182	[0199]
11	0187	0142	0169	0289	0275	[0295]	0281	0311	0213	0222	0102	0305
12	0079	[0132]	[0166]	0388	0256	0417	0337	0294	0231	0189	[0142]	0141
13	0062	0182	0242	0292	0170	0361	0330	[0289]	0182	0149	0213	0149
14	0120	0144	0124	0340	[0281]	0188	0290	0285	0144	0277	0153	0070
15	[0097]	0146	0136	0362	0366	0307	0231	0222	0132	[0274]	0103	0045
16	0099	0149	0219	[0317]	0333	0285	[0275]	0196	0152	0567	0114	0043
17	0140	0090	0182	0332	0287	0321	0259	0239	[0200]	0196	0109	[0058]
18	0078	0139	0335	0355	0274	[0303]	0281	0213	0183	0267	0119	0102
19	0098	[0117]	[0217]	0223	0202	0348	0256	0251	0370	0182	[0101]	0028
20	0083	0115	0143	0193	0280	0294	0212	[0282]	0220	0242	0099	0061

TABLE XIII.—Continued.

Civil Day.	January.	February.	March.	April.	May.	June.	July.	August.	September.	October.	November.	December.
21	^{0.0} 0075	^{0.0} 0101	^{0.0} 0206	^{0.0} 0166	^{0.0} [0251]	^{0.0} 0263	^{0.0} 0229	^{0.0} 0206	^{0.0} 0191	^{0.0} 0130	^{0.0} 0124	^{0.0} 0089
22	[0089]	0110	0218	0144	0220	0187	0173	0346	0246	[0186]	0042	0039
23	0094	0083	0140	[0193]	0236	0297	[0561]	0439	0362	0165	0107	0066
24	0089	0210	0195	0165	0298	0227	0703	0371	[0245]	0183	0150	[0094]
25	0096	0164	0119	0235	0224	[0278]	1627	0341	0188	0211	0128	0104
26	0075	[0119]	[0161]	0257	0438	0340	0421	0241	0235	0202	[0107]	0074
27	0094	0092	0146	0357	0331	0278	[0297]	0249	0188	0064	0192
28	0160	0119	0151	[0312]	0285	0231	0213	0334	0209	0099	0187
29	[0100]		0215	0230	0339	0308	0372	0371	0261	[0214]	0096	0095
30	0115		0240	[0231]	0252	0349	[0277]	0246	0139	0163	0077	0128
31	0086		0206		0266		0285	0221		0330		[0135]
Mean	01061	01191	01774	03116	03130	02899	03683	03139	02484	02227	01278	01223

From the means at the foot of Table XIII. it will be seen that the least mean is that for January, and the greatest that for July; the same results may be deduced from these quantities as from the ranges of the monthly means, thus—

	Jan. & Dec.	Feb. & Nov.	March & Oct.	April & Sept.	May & Aug.	June & July.
Ranges,	0.001141	0.001234	0.002000	0.002802	0.003134	0.003291
Differences,	0.000093	0.000766	0.000802	0.000332	0.000155	

The mean of the diurnal ranges is about three times as great for the summer months as for the winter months.

If we take the differences of the monthly means of the diurnal ranges, and of the diurnal ranges of the monthly means, we shall have some measure of those irregularities which cause the two to differ.

From the means for each couple of months we have the following differences :—

Monthly means of the diurnal ranges, *minus* the diurnal ranges of the monthly means.

Jan. & Dec.	Feb. & Nov.	March & Oct.	April & Sept.	May & Aug.	June & July.
0.000514	0.000507	0.000527	0.000558	0.000493	0.000449

The difference is greater at the solstices than in the winter or summer, and is least in summer.

TABLE XIV.—Diurnal Ranges of the Horizontal Component of Magnetic Force, with reference to the Moon's Age and Declination for 1843.

Moon's Age.	Mean Diurnal Range.	Moon's Age.	Mean Diurnal Range.	After Moon farthest North.	Mean Diurnal Range.	After Moon farthest North.	Mean Diurnal Range.
Day.	^{0.00}	Day.	^{0.00}	Day.	^{0.00}	Day.	^{0.00}
15	2525	0	2217	0	2931	14	2375
16	2232	1	1792	1	2672	15	2022
17	2445	2	2015	2	3249	16	1960
18	2183	3	2198	3	3050	17	2026
19	2082	4	2237	4	2981	18	2166
20	1941	5	2037	5	2248	19	1858
21	2093	6	3207	6	2370	20	2168
22	1865	7	3227	7	2332	21	2146
23	2024	8	2756	8	2211	22	2057
24	1630	9	2337	9	2185	23	1925
25	1996	10	2303	10	1942	24	2124
26	2131	11	2405	11	2116	25	2088
27	2596	12	2430	12	2593	26	1962
28	3254	13	2422	13	2438	27	2437
29	2310	14	2321				

Table XIV. was formed from Table XIII. in the manner indicated for the declination Table II. MAG. AND MET. OBS. 1843.

DIURNAL RANGES OF THE HORIZONTAL COMPONENT OF MAGNETIC FORCE, WITH REFERENCE TO THE RELATIVE POSITIONS OF THE SUN, MOON, AND EARTH, AS INDICATED BY THE MOON'S AGE.

The general aspect of the partial means, if we reject those for the 28th, 6th, and 7th days, which are much affected by disturbances, is that of a *minimum near the time of new moon, and a maximum near the time of full moon.*

Means of Groups.

14 days to 16 days, Full Moon, 0.002359	29 days to 1 day, New Moon, 0.002106
17 20 ... 0.002163	2 5 ... 0.002122
21 24 ... 0.001903	6 9 ... 0.002882
25 28 ... 0.002494	10 13 ... 0.002390

DIURNAL RANGES OF THE HORIZONTAL COMPONENT OF MAGNETIC FORCE, WITH REFERENCE TO THE MOON'S DECLINATION.

Means of Groups.

27 days to 1 day, Moon farthest North, 0.002680	13 days to 15 days, Moon farthest South, 0.002278
2 5 ... 0.002882	16 19 ... 0.002002
6 8 ... 0.002304	20 22 ... 0.002124
9 12 ... 0.002209	23 26 ... 0.002025

These and the partial means indicate *maxima about the periods of greatest north and south declinations, and minima when the declination is zero*; the maximum at the period of greatest south declination is not well marked.

VERTICAL COMPONENT OF MAGNETIC FORCE.

TABLE XV.—Mean Values of the Variations of the Vertical Component of Magnetic Force (the whole Vertical Component being Unity), for each Civil Day as deduced from the Nine Daily Observations, for each Week, and for each Month in the year 1843.

Civil Day.	January.	February.	March.	April.	May.	June.	July.	August.	September.	October.	November.	December.
1	0.01 [.....]	0.01 6830	0.01 6621	0.01 6034	0.01 5974	0.01 5952	0.01 5837	0.01 5696	0.01	0.01 [5251]	0.01 5475	0.01 5330
2	7042	6896	6635	[6159]	5971	5905	[5953]	5688	5134	5431	5370
3	6997	6853	6606	6032	5939	5937	5879	5633	[.....]	5203	5471	[5260]
4	7078	6772	6538	6077	5951	[5919]	6013	5895	5182	5282	5089
5	7020	[6834]	6686	6680	5996	5904	5902	5713	5037	[5345]	5198
6	6988	6869	6553	6282	5702	5886	5886	[5620]	5358	4980	5227	5291
7	6933	6821	7120	6224	[5965]	5931	6005	5574	5475	4931	5283	5152
8	[6991]	6792	6664	6310	6102	5935	5982	5549	5552	[5160]	5378	5300
9	6881	6809	6715	[6258]	5969	6024	[5964]	5351	5519	5341	5367	5146
10	6984	6820	6606	6113	6073	5989	5988	5683	[5494]	5327	5412	[5223]
11	7140	6652	6513	6218	6034	[6042]	5934	5748	5552	5341	5345	5180
12	7012	[6744]	[6569]	6400	6107	6114	5992	5673	5462	5334	[5386]	5294
13	6997	6696	6587	6152	6054	6133	5862	[5737]	5404	5519	5265
14	7041	6737	6507	6101	[6063]	6058	5823	5789	5538	5548	5314	5223
15	[6988]	6746	6484	6247	6034	6034	5825	5800	5321	[5536]	5488	5183
16	6927	6758	6452	[6160]	6089	6033	[5828]	5732	5408	5554	5430	5195
17	6983	6747	6502	6097	6062	6196	5856	5717	[5385]	5750	5340	[5181]
18	6969	6667	6524	6197	5962	[6027]	5829	5869	5262	5511	5351	5183
19	6890	[6701]	[6421]	6172	6013	6072	5775	5967	5344	5199	[5304]	5137

TABLE XV.—Continued.

Civil Day.	January.	February.	March.	April.	May.	June.	July.	August.	September.	October.	November.	December.
20	6980	6689	6371	6171	6025	5945	5849	[6049]	5437	5417	5254	5169
21	6972	6671	6314	6173	[5959]	5973	5713	6117	5242	5415	5258	5173
22	[6853]	6677	6358	6144	5927	5883	5819	6214	5325	[5356]	5188	5169
23	6700	6690	6294	[6070]	5905	5953	[5925]	5391	5300	5279	5147
24	6712	6981	6330	5971	5920	5999	5742	[5385]	5344	5292	[5163]
25	6870	6658	6275	5956	5917	[5981]	6619	5921	5461	5460	5337	5087
26	6878	[6718]	[6252]	6005	5778	6008	5805	5866	5502	5649	[5287]	5159
27	6787	6705	6235	6037	5930	6014	5670	[5805]	5389	5596	5243	5247
28	7000	6651	6164	6049	[5888]	6030	5683	5748	5396	5469	5301	5314
29	[6860]		6216	5990	5900	6050	5773	5686	5449	[5557]	5269	5184
30	6833		6105	[5993]	5868	6035	[5701]	5609	5141	5626	5282	5207
31	6833		6025		5932		5702	5652		5532		[5206]
Means.	6940	6758	6457	6153	5968	5997	5875	5757	5405	5373	5332	5207

Table XV. was formed in the following manner; the means of the balance micrometer readings, corrected for temperature, were first obtained for each civil day, and these means were reduced to parts of the vertical component by the following formulæ:—

$$\begin{aligned} \text{January 1—August 22. } f &= n \times 0.000009 \\ \text{August 25—August 31. } f &= (n - 160) 0.000009 \\ \text{September 6—November 11. } f &= (n - 222) 0.000009 \\ \text{November 14—December 31. } f &= (n - 260) 0.000009 \end{aligned}$$

Where f is the quantity in the previous Table and n the mean micrometer reading corrected for temperature.

The balance needle was removed three times in 1843 for the purpose of determining its temperature correction, namely, on August 23 and 24, on September 1, 2, 3, 4, and 5, and on November 13. These removals necessarily broke the series of observations, but it is conceived that the different portions after August have been reduced to nearly the values which they would have had, had there been no removal, by the following methods:—

1st, To connect the observations after November 13, with those immediately before it,—

Mean of the micrometer readings, week, Oct. 16—	21.	= 830.3	} Change in 14 days = {
..... Oct. 23—	28.	= 829.8	
..... Oct. 30—Nov. 4.	= 829.7		
..... Nov. 6—	11.	= 814.8	
..... period, Oct. 16—Nov. 11.		= 826.1, before adjustment.	

The mean corresponding to October 30 is, therefore, 826.1, and the mean change for 14 days being -7.8 , the mean corresponding to November 13 will be 818.3.

Mean of micrometer readings, week, Nov. 14—	18.	= 858.3	} Change in 14 days = {
..... Nov. 20—	25.	= 845.3	
..... Nov. 27—Dec. 2.	= 848.8		
..... Dec. 4—	9.	= 837.3	
..... period, Nov. 14—Dec. 9.		= 847.4, after adjustment.	

The mean corresponding to November 27 is, therefore, 847.4, and the mean change for 14 days being -8.7 , the mean corresponding to November 13 will be 856.1. This gives nearly 38.0 micrometer divisions more than the previous result; 38.0 was therefore subtracted from all the daily means in micrometer divisions after November 13, 1843.

It will be obvious from a consideration of the above weekly means, that this correction cannot be far from the truth; indeed, the mean of the micrometer readings for November 10 and 11 is 819·6, and for November 14 and 15 is 860·1, which, supposing the change for two days small, will give nearly the same difference.

2d, To connect the observations after September 6, with those before August 22.

This has been a matter of greater difficulty than in the previous case, both on account of the greater interval elapsed, and also on account of considerable changes occurring in the daily means before August 23; for this reason, the weekly changes could not be compared with any confidence, and the following method was adopted:—

Mean of balance magnetometer readings corrected, January 1842—August 1842,	= 920·3
..... January 1843—August 1843,	= 693·0
	= 227·3
Annual change corresponding to the beginning of May 1842-43,	= 227·3
Mean of the balance magnetometer readings corrected, September 1843—April 1844,	= 783·0
..... September 1844—April 1845,	= 585·0
	= 198·0
Annual change corresponding to the beginning of January 1844-1845,	= 198·0
Hence, mean annual change corresponding to the beginning of March 1843-1844,	= 213·0
Mean of balance magnetometer readings corrected September 1842—August 1843, } corresponding to the beginning of March 1843, }	} = 736·0
	= 523·0
Therefore the mean in the beginning of March 1844 <i>should be</i>	= 523·0
But the mean, September 1843 to August 1844, corresponding to the mean in the } beginning of March 1844, <i>was</i> }	} = 745·0
	= 222·0
Whence the micrometer readings after September 1843 are more than those before } September 1843, by }	} 222·0

After the corrections in the first case had been made, all the means after September 5, 1843 were corrected by -222·0 micrometer divisions, which, it is believed, is not far from the truth. The correction for the six daily means, August 25-31, was obtained by interpolating between the means of the preceding and succeeding weeks for the mean of the six days, the correction applied was -160 micrometer divisions.

As it has been found from the observations in 1844, that, in the month of January, the mean of the 4 daily observations corresponding to those made in the first week of January 1843, and of the 8 corresponding to those made in the second week, differ little from the mean of the whole 24, no correction has been applied to the means of the 4 or 8 daily observations.

ANNUAL PERIOD OF THE VERTICAL COMPONENT OF THE MAGNETIC FORCE.

Differences of the monthly means deduced from the observations in 1844, at the hours 18, 20, . . . 10, from those deduced from the 24 hourly observations made on each day (excepting Sundays) in that year:—

24 observations *minus* 9 observations.

Jan.	Feb.	March.	April.	May.	June.	July.	Aug.	Sept.	Oct.	Nov.	Dec.
-0·0000 16	16	32	70	59	12	22	66	66	74	55	14

These quantities being applied as corrections to the monthly means at the foot of Table XV., we obtain the following:—

Jan.	Feb.	March.	April.	May.	June.	July.	Aug.	Sept.	Oct.	Nov.	Dec.
0·01 6924	6742	6375	6083	5909	5984	5853	5691	5339	5299	5277	5193

From these it appears that the vertical component diminishes considerably from January till May, increases from May till June, diminishes slowly from June till August, more rapidly till September, and slowly from Sep-

tember till December. The diminution from January till December is 0.001731; if we refer to the previous attempt to connect the different series of observations, we find the mean annual diminution from the beginning of March 1843 till the beginning of March 1844 = 213 micrometer divisions; this, together with the *rate* of this change, will give 210 micrometer divisions (= 0.001890) for the diminution from January 1843 to January 1844. If proportional parts of this be applied to the monthly means above, the secular change will be eliminated, and the annual period rendered more distinct. The corrected means are as follow:—

	Jan.	Feb.	March.	April.	May.	June.	July.	Aug.	Sept.	Oct.	Nov.	Dec.
0.01	6924	6899	6690	6555	6539	6771	6798	6793	6599	6716	6852	6925

This indicates a maximum at mid-winter and at mid-summer, a minimum about April and a minimum in September. It seems, therefore, very probable that the same law holds for the vertical component as has already been shewn to exist for the horizontal component, namely, *maxima at the solstices, and minima at the equinoxes.*

From the above the minima at the equinoxes seem to differ little, but the maximum at the winter solstice is considerably greater than that at the summer solstice.

The range of the annual period is 0.000386.

TABLE XVI.—Mean Variations of the Vertical Component of Magnetic Force, after eliminating the Secular Change, with reference to the Moon's Age, Declination, and Distance from the Earth, for 1843.

Moon's Age.	Variations of Vertical Component.	Moon's Age.	Variations of Vertical Component.	After Moon farthest North.	Variations of Vertical Component.	After Moon farthest North.	Variations of Vertical Component.	Before and after Perigee.	Variations of Vertical Component.	Before and after Apogee.	Variations of Vertical Component.
Day.	0.000	Day.	0.000	Day.	0.000	Day.	0.000	Day.	0.000	Day.	0.000
15	055	0	025	0	136	14	077	7	118	7	078
16	056	1	017	1	094	15	063	6	108	6	054
17	081	2	050	2	151	16	046	5	191	5	067
18	057	3	076	3	096	17	013	4	101	4	067
19	048	4	035	4	091	18	035	3	071	3	041
20	077	5	024	5	060	19	013	2	078	2	043
21	076	6	147	6	062	20	020	1	107	1	053
22	058	7	045	7	069	21	016	P	073	A	055
23	076	8	068	8	067	22	012	1	071	1	000
24	057	9	057	9	047	23	030	2	105	2	046
25	090	10	049	10	040	24	000	3	105	3	064
26	071	11	062	11	031	25	062	4	091	4	114
27	028	12	000	12	055	26	045	5	090	5	114
28	144	13	009	13	090	27	090	6	046	6	129
29	051	14	011					7	064	7	110

Table XVI. was formed from Table XV. in the manner already indicated, Table II. for the declination.

VARIATIONS OF THE VERTICAL COMPONENT OF MAGNETIC FORCE WITH REFERENCE TO THE RELATIVE POSITIONS OF THE SUN, MOON, AND EARTH, AS INDICATED BY THE MOON'S AGE.

The means shew, with considerable irregularities, *maxima near the quadratures, and minima near the syzgies.* The principal minimum occurs at the period of full moon, the following means of groups give the same result:—

14 days to 16 days, Full Moon,	0.000041	29 days to 1 day, New Moon,	0.000031
17 20 ...	0.000066	2 5 ...	0.000046
21 24 ...	0.000067	6 9 ...	0.000079
25 28 ...	0.000083	10 13 ...	0.00003.

VARIATIONS OF THE VERTICAL COMPONENT OF MAGNETIC FORCE, WITH REFERENCE TO THE
MOON'S DECLINATION.

The second portion of Table XVI., in groups, gives the following means :—

27 days to 1 day, Moon farthest North,	0·000107	13 days to 15 days, Moon farthest South,	0·000077
2 5 ...	0·000099	16 19 ...	0·000027
6 8 ...	0·000066	20 22 ...	0·000016
9 12 ...	0·000043	23 26 ...	0·000034

These means indicate a well marked minimum at the passage of the equator northwards ; a well marked maximum at the period of greatest north declination ; a diminution of the component from thence till after the passage of the equator southwards ; and a secondary maximum at the greatest south declination. Though the latter is not well shewn in these groups, the means on the whole shew, *maxima of the vertical component at the periods of greatest north and south declination, and minima when the declination is zero.*

VARIATIONS OF THE VERTICAL COMPONENT OF MAGNETIC FORCE, WITH REFERENCE TO THE MOON'S
DISTANCE FROM THE EARTH.

Means of Groups.

6 days after Apogee to 6 days before Perigee,	0·000116	6 days after Perigee to 6 days before Apogee,	0·000060
5 days to 2 days before Perigee, . . .	0·000110	5 days to 2 days before Apogee, . . .	0·000054
1 day before to 1 day after Perigee, . . .	0·000084	1 day before to 1 day after Apogee, . . .	0·000036
2 days to 5 days after Perigee, . . .	0·000098	2 days to 5 days after Apogee, . . .	0·000084

TABLE XVII.—Means of the Balance Magnetometer Readings corrected for Temperature at the
Observation Hours for each Month in 1843.

Month.	18 ^h .	20 ^h .	22 ^h .	23 ^h .	0 ^h .	2 ^h .	4 ^h .	6 ^h .	8 ^h .	10 ^h .
January	Mic. Div. 756·0	Mic. Div. 762·6	Mic. Div. 765·7	Mic. Div.	Mic. Div. 768·3	Mic. Div. 769·2	Mic. Div. 767·7	Mic. Div. 774·4	Mic. Div. 777·0	Mic. Div. 774·7
February	740·0	745·5	746·6		744·2	745·5	753·2	761·9	763·9	757·2
March	707·5	713·8	715·9		708·6	707·1	715·8	730·0	735·5	722·0
April	662·2	668·9	676·9		669·7	670·4	688·3	721·6	709·2	685·9
May	659·8	667·0	664·5		650·5	649·4	665·2	674·7	679·6	657·4
June	662·2	671·4	668·6		655·6	651·4	664·6	677·3	675·8	669·4
July	638·9	647·6	651·3		643·7	648·6	659·4	664·5	667·8	653·7
	628·2	638·5	641·7		624·8	634·5	643·6	656·4	653·3	638·8
August	793·1	803·4	803·1		790·2	790·5	799·7	807·6	806·0	793·4
September	805·9	823·5	829·0		817·8	824·4	831·5	836·0	824·7	810·9
October	801·1	812·0	821·1		819·4	821·5	830·9	829·9	821·3	814·0
	804·2	808·4	817·8	819·3	821·2	827·0	829·5	821·3	818·9	816·9
November	841·1	843·1	845·4	840·7	841·3	849·3	856·9	856·0	859·3	855·9
December	824·2	826·1	830·2	829·6	833·4	839·9	848·1	849·1	853·4	842·9

Table XVII. is intended chiefly as a key for comparing the tabular observations. The cross lines in the Table indicate that a break has occurred in the series ; the means so separated are not comparable with each other. The periods at which the needle was removed have been already mentioned.—See remarks to Table XV.

The mean at 18^h in January is rendered comparable with the means at the other hours, thus :—

	Mic. Div.
Mean of balance magnetometer readings, January 9—31.	= 768·8
..... January 16—31.	= 764·5
Difference,	= 4·3

The mean for 18^h deduced from the observations January 16 to 31 was therefore corrected by + 4·3 micrometer divisions, in order to reduce it to the mean from January 9 to 31, as for the other hours.

TABLE XVIII.—Diurnal Variations of the Vertical Component of Magnetic Force in 1843, the whole Vertical Component being Unity.

Periods.	18 ^h .	20 ^h .	22 ^h .	23 ^h .	0 ^h .	2 ^h .	4 ^h .	6 ^h .	8 ^h .	10 ^h .	Range.
January	0000	0059	0087	0000	0111	0119	0105	0166	0189	0168	0189
February	0000	0049	0059		0038	0049	0119	0197	0215	0155	0215
March	0004	0060	0079		0013	0000	0078	0206	0256	0134	0256
April	0000	0060	0132		0067	0074	0235	0535	0423	0213	0535
May	0094	0158	0136		0010	0000	0142	0228	0272	0072	0272
June	0097	0180	0155		0038	0000	0119	0233	0220	0162	0233
July	0000	0078	0112		0043	0087	0184	0230	0260	0133	0260
August	0030	0122	0133		0000	0067	0149	0254	0230	0103	0254
September	0000	0158	0208		0107	0166	0230	0271	0169	0045	0271
October	0000	0098	0180		0165	0184	0268	0259	0182	0116	0268
November	0000	0026	0073	0052	0063	0127	0176	0142	0151	0126	0176
December	0000	0017	0054	0049	0083	0141	0215	0224	0263	0168	0263
Spring	0000	0055	0089		0038	0040	0143	0312	0297	0166	0312
Summer	0035	0110	0105		0001	0000	0119	0201	0222	0093	0222
Autumn	0000	0116	0167		0081	0129	0206	0251	0184	0078	0251
Winter	0000	0034	0071		0086	0129	0165	0177	0201	0154	0201
Winter Solstice	0000	0038	0068		0074	0109	0154	0182	0204	0154	0204
Equinoxes	0000	0093	0149		0087	0105	0202	0317	0257	0126	0317
Summer Solstice	0032	0111	0113		0000	0015	0125	0213	0222	0095	0222
The Year	0000	0070	0100		0043	0066	0149	0227	0217	0114	0227

DIURNAL VARIATION OF THE VERTICAL COMPONENT OF MAGNETIC FORCE.

An examination of the monthly means will shew, that they may be arranged into three very distinct groups, namely, the months January, February, November, and December, about the winter solstice; the months March, April, September, and October, about the equinoxes; and the months May, June, July, and August, about the summer solstice. A consideration of the monthly means, however, will shew, that the diurnal curves pass gradually from the type of the one group to that of the next following.

In the means of the months about the winter solstice there is but one maximum and one minimum distinctly shewn; the *diurnal curve is single*.

The minimum occurs *before* 5^h 10^m A.M., Makerstoun mean time.

The maximum occurs between 6^h and 7^h P.M.,

There is a slight inflexion in the curve about 11 A.M., tending to a minimum; this minimum is more or less shewn in the separate monthly means, but never very distinctly excepting in February.

In the mean of the months, about the equinoxes, there are two maxima and two minima shewn; the *diurnal curve is double* :—

The minimum occurs between 9^h P.M. and 5^h A.M., Makerstoun mean time.

The maximum occurs at 5^h 10^m P.M.,

A secondary maximum occurs about 9^h 10^m A.M.,

A secondary minimum 11^h 40^m A.M.,

Each of the four months gives nearly the same result. In the means of the months about the summer solstice, there are two maxima and two minima, *the diurnal curve is also double* :—

The minimum (as far as it can be deduced from the 9 observations), occurs at Noon, Makerstoun mean time.
 The maximum occurs about 6^h 10^m P.M.,
 A minimum occurs between 9^h P.M. and 5^h A.M.,
 A secondary maximum occurs about 8^h A.M.,

Whether the principal maximum occurs near noon or near midnight cannot be determined from the observations, but an examination of the monthly means will shew that the noon minimum becomes more marked from January till June, and then becomes less so till December.

The result for the whole year is exactly that for the equinoctial months.

As the above results agree on the whole with those for the year 1844,* it may be permissible to conclude, that,—

1st. The diurnal curve is single in winter, unequally double at the equinoxes, and nearly equally double at midsummer.

2d. The minimum near noon occurs at the same hour in the equinoctial and summer months; the morning maximum occurs nearer noon in the equinoctial than in the summer months; the principal or evening maximum occurs nearly at the same hour in the winter and summer months, and farther from noon than in the equinoctial months.

In order to determine the period of the principal minimum, the observations made at 0^m on the term-days of 1842 and 1843 have been used. The observations in 1842 were corrected by various temperature coefficients, depending on the method of deflections, the means in the following table were obtained after farther corrections had been applied for the differences of the first coefficients from that obtained by comparisons of the daily observations. The means in the following table are deduced from the term observations at 0^m in 1842 thus corrected, and, from the term observations in 1843, as corrected in this volume. The winter solstice includes the months of November, December, January, and February, 1842 and 1843; the equinoxes, the months of March, April, September, and October, 1842 and 1843; and the summer solstice, the months of May, June, July, and August, 1842 and 1843.

TABLE XIX.—Diurnal Variations of the Vertical Component of Magnetic Force, deduced from the Observations at 0^m on the Term-Days of 1842 and 1843, the whole Vertical Component being Unity.

Hour.	Winter Solstice.	Equinoxes.	Summer Solstice.	1842.	1843.	Mean.	Hour.	Winter Solstice.	Equinoxes.	Summer Solstice.	1842.	1843.	Mean.
	0-00	0-00	0-00	0-00	0-00	0-00		0-00	0-00	0-00	0-00	0-00	0-00
10	0250	0572	0299	0492	0281	0357	22	0141	0589	0351	0510	0238	0344
11	0190	0532	0256	0410	0267	0309	23	0151	0590	0298	0478	0240	0329
12	0080	0420	0153	0292	0170	0201	0	0184	0552	0241	0460	0218	0309
13	0000	0083	0029	0000	0101	0021	1	0220	0517	0233	0478	0194	0306
14	0051	0000	0000	0008	0052	0000	2	0229	0510	0288	0500	0211	0326
15	0078	0064	0036	0144	0000	0042	3	0225	0556	0359	0547	0238	0363
16	0077	0099	0073	0186	0007	0067	4	0251	0671	0382	0622	0274	0418
17	0063	0178	0189	0264	0049	0126	5	0248	0729	0401	0632	0313	0443
18	0058	0312	0262	0345	0103	0194	6	0228	0783	0425	0638	0345	0462
19	0083	0420	0341	0447	0142	0265	7	0227	0788	0441	0661	0336	0469
20	0095	0530	0336	0483	0184	0303	8	0197	0707	0473	0632	0313	0443
21	0129	0587	0347	0492	0242	0337	9	0194	0604	0448	0563	0293	0399

In the mean for all the periods, the principal minimum occurs at midnight, or 1^h A.M. In the mean for both years, the principal minimum occurs at 1^h A.M. The principal minimum perhaps occurs nearer noon in

* Transactions of the Royal Society of Edinburgh, Vol. XVI., p. 137.

winter than in summer, as there is an indication of a minimum about 5^h A.M. The following are the results from the mean of both years :—

- The principal minimum at 1^h 10^m A.M., Makerstoun mean time.
- The principal maximum at 6^h P.M.,
- A secondary maximum at 9^h 10^m A.M.,
- A secondary minimum at 11^h 40^m A.M.,

The same results may be deduced from these means as have been already deduced from the means Table XVIII.

SECULAR CHANGE OF THE VERTICAL COMPONENT OF MAGNETIC FORCE.

The means for the year 1844 shew that the means of the observations at 22^h and 0^h, and at 4^h and 6^h, are respectively very nearly the same as the means of the observations at 23^h and 5^h. Assuming that they are equal for the year 1843, we shall have from the means for the year at the foot of Table XVIII. = 0.000100 and from the mean for the year deduced from the means at the the foot of Table XV. = 0.015935.

- Mean at 20^h less than the mean of 9 observations from Table XVIII. by 0.000040, or = 0.015895
- Mean for 23^h 0.000039, or = 0.015896
- Mean at 2^h 0.000044, or = 0.015891
- Mean for 5^h greater 0.000078, or = 0.016013

From Table XVII., Abstracts for the observations of 1842, we have the means in micrometer divisions at the corresponding hours in 1842, these being converted into parts of force by the first formula given in the remarks to Table XV. we have,

1842 ; 20^h = 0.017902, 23^h = 0.017962, 2^h = 0.017980, 5^h = 0.018147.

The means above for 1843 being subtracted from these, we have—

Secular change, 20^h = -0.002007, 23^h = -0.002066, 2^h = -0.002089, 5^h = -0.002134.
 Mean secular change 1842 to 1843, = -0.002074.

RANGES OF THE MONTHLY MEANS OF THE DIURNAL VARIATIONS.

The ranges given in the last column of Table XVIII. must be very imperfect for some months, since the minimum actually occurs in general a little after midnight. It is very obvious, however, that the range is greatest at the equinoxes, and that it differs little in summer from winter, thus the diurnal range of the mean for the winter group of months is 0.000204, for the summer group 0.000222, while for the group at the equinoxes it is 0.000317. The corresponding groups in Table XIX. give the following ranges :—

Diurnal range ; winter group = 0.000251 ; summer group = 0.000492 ; equinoctial group = 0.000788 ;
 or nearly in the ratios of 1, 2, and 3.

TABLE XX.—Diurnal Ranges of the Vertical Component of Magnetic Force, as deduced from the 9 Daily Observations in 1843, with the Weekly and Monthly Means.

Civil Day.	January.	February.	March.	April.	May.	June.	July.	August.	September.	October.	November.	December.
	0.00	0.00	0.00	0.00	0.00	0.00	0.00	0.00	0.00	0.00	0.00	0.00
1	[.....]	0227	0130	0226	0168	0292	0492	0211	[0481]	0442	0400
2	0959	0099	0111	[0865]	0258	0414	[0363]	0297	0421	0213	0468
3	0356	0159	0135	0371	0314	0597	0406	0366	[.....]	0501	0681	[0270]
4	0056	0162	0474	0332	0338	0405]	0185	1536	0282	0312	0184
5	0096	[0283]	[0810]	3738	0200	0469	0238	0288	1011	[0327]	0286
6	0251	0802	0434	0373	2713	0264	0274	[0798]	0262	0396	0217	0166
7	0267	0355	3300	1416	[0894]	0398	0300	0266	0436	0228	0303	0247
8	[0360]	0123	0407	1330	0512	0421	0945	0807	0459	[0341]	0232	1177
9	0610	0280	0322	[0838]	1010	0139	[0361]	1526	0542	0139	0373	0555
10	0259	0165	0191	0363	0590	0254	0378	0353	[0459]	0133	0246	[0633]
11	0676	0276	0163	0434	0185	[0387]	0140	0399	0418	0141	0105	0822
12	0133	[0351]	[0347]	1112	0145	0499	0129	0143	0446	0210	[0264]	0552

TABLE XX.—Continued.

Civil Day.	January.	February.	March.	April.	May.	June.	July.	August.	September.	October.	November.	December.
13	0172	0440	0634	0738	0403	0691	0461	[0283]	0451	0402	0445
14	0127	0724	0446	0835	[0417]	0318	0523	0407	0324	0430	0380	0100
15	[0149]	0224	0327	0473	0882	0210	0206	0256	0324	[0387]	0213	0184
16	0127	0340	0234	[0573]	0584	0642	[0307]	0142	0309	0412	0356	0083
17	0211	0297	0445	0299	0303	0211	0281	0244	[0377]	0553	0139	[0201]
18	0129	0411	0709	0835	0400	[0302]	0229	0318	0252	0316	0301	0337
19	0298	[0287]	[0389]	0259	0322	0265	0233	0275	0769	0590	[0236]	0152
20	0059	0364	0218	0277	0285	0365	0157	[0344]	0284	0790	0114	0347
21	0119	0110	0207	0287	[0328]	0212	0292	0175	0468	0210	0289	0205
22	[0185]	0199	0517	0145	0304	0240	0305	0706	0896	[0383]	0218	0118
23	0157	0139	0383	[0239]	0366	0354	[0706]	0562	0231	0256	0115
24	0175	1483	0197	0382	0294	0290	0823	[0497]	0280	0380	[0210]
25	0302	0440	0166	0169	0497	[0298]	2258	0463	0408	0200	0261	0155
26	0107	[0407]	[0291]	0178	0885	0395	0399	0356	0419	1010	[0274]	0103
27	0159	0102	0122	0381	0274	0269	0643	[0316]	0226	0679	0094	0563
28	1331	0148	0103	0210	[0511]	0238	0190	0191	0861	0130	0447	0395
29	[0400]		0773	0246	0539	0235	0438	0260	0407	[0491]	0207	0101
30	0441		0325	[0263]	0531	0618	[0390]	0309	0414	0472	0115	0290
31	0131		0197		0339		0558	0344		0217		[0295]
Mean	0297	0337	0432	0616	0506	0357	0442	0426	0452	0400	0275	0328

TABLE XXI.—Diurnal Ranges of the Vertical Component of Magnetic Force, with reference to the Moon's Age and Declination for 1843.

Moon's Age.	Mean Diurnal Range.	Moon's Age.	Mean Diurnal Range.	After Moon farthest North.	Mean Diurnal Range.	After Moon farthest North.	Mean Diurnal Range.
Day.	0000	Day.	0000	Day.	0000	Day.	0000
15	411	0	362	0	603	14	528
16	346	1	261	1	383	15	362
17	461	2	255	2	567	16	351
18	338	3	434	3	463	17	421
19	361	4	392	4	724	18	273
20	306	5	343	5	397	19	331
21	325	6	877	6	448	20	308
22	311	7	624	7	437	21	327
23	229	8	540	8	371	22	307
24	275	9	403	9	342	23	325
25	408	10	472	10	270	24	397
26	368	11	411	11	298	25	514
27	424	12	444	12	475	26	301
28	607	13	493	13	469	27	461
29	387	14	385				

This Table has been formed from Table XX., in the manner indicated for the declination, Table VII.

DIURNAL RANGES OF THE VERTICAL COMPONENT OF MAGNETIC FORCE, WITH REFERENCE TO THE MOON'S AGE.

The general aspect of the partial means is exactly similar to that of the means for the horizontal component, Table XIV., and, with similar exceptions, namely, of the means for the 28th, 6th, and 7th days, the result is the same, or a *minimum about the time of new moon, and a maximum about the time of full moon.*

Means of Groups.

14 days to 16 days, Full Moon,	0·000381	29 days to 1 day, New Moon,	0·000337
17 20 ...	0·000366	2 5 ...	0·000356
21 24 ...	0·000285	6 9 ...	0·000611
25 28 ...	0·000452	10 13 ...	0·000455

DIURNAL VARIATIONS OF THE VERTICAL COMPONENT OF MAGNETIC FORCE, WITH REFERENCE TO THE MOON'S DECLINATION.

Means of Groups.

27 days to 1 day, Moon farthest North,	0·000482	13 days to 15 days, Moon farthest South,	0·000453
2 5 ...	0·000537	16 19 ...	0·000344
6 8 ...	0·000419	20 22 ...	0·000314
9 12 ...	0·000346	23 26 ...	0·000384

These means shew the same result as that already obtained for the horizontal component (Table XIV.), namely, *maxima about the periods of greatest north and south declination, and minima near the periods when the declination is zero*; the maximum at the period of greatest south declination is better marked than for the horizontal component; the principal minimum occurs when the moon is moving northwards.

MAGNETIC DIP.

The following results are deduced from the variations of the horizontal and vertical components by means of the formula

$$\Delta \theta = \frac{\frac{1}{2} \sin 2 \theta}{0\cdot0002909} \left(\frac{\Delta Y}{Y} - \frac{\Delta X}{X} \right)$$

where $\frac{\Delta Y}{Y}$ is the quantity in the tables for the vertical component, $\frac{\Delta X}{X}$ the quantity in those for the horizontal component, θ , the magnetic dip assumed to be $71^\circ 18'$, $\Delta \theta$ the variations of dip given in the following tables. and 0·0002909 the value of 1' in parts of radius.

SECULAR CHANGE OF MAGNETIC DIP.

From the mean secular changes for the two components of magnetic force, pages 235 and 245, we obtain

$$\text{Mean Secular Change of Magnetic Dip 1842 to 1843} = - 4\cdot92.$$

ANNUAL PERIOD OF MAGNETIC DIP.

From the quantities, pages 231 and 241, exhibiting the annual periods of the two components of magnetic

force (the secular changes being eliminated), the following quantities have been obtained, which shew the variations of the magnetic dip for the different months of the year :—

Jan.	Feb.	March.	April.	May.	June.	July.	Aug.	Sept.	Oct.	Nov.	Dec.
0·145	0·374	0·605	0·518	0·000	0·106	0·470	0·636	0·377	0·578	0·360	0·269

These quantities indicate *maxima of magnetic dip about the periods of the equinoxes, and minima about the periods of the solstices.*

TABLE XXII.—Diurnal Variations of Magnetic Dip, deduced from Tables XI. and XVIII.

Period.	1 ^h .	2 ^h .	22 ^h .	23 ^h .	0 ^h .	2 ^h .	4 ^h .	6 ^h .	8 ^h .	10 ^h .	Range.
January	0·158	0·235	0·714		0·697	0·208	0·000	0·321	0·460	0·406	0·714
February	0·331	0·043	0·618		0·468	0·129	0·000	0·368	0·290	0·328	0·618
March	0·503	0·633	1·262		1·238	0·386	0·000	0·114	0·403	0·380	1·262
April	0·900	1·086	2·116		1·922	0·801	0·176	0·000	0·519	0·870	2·116
May	1·505	1·980	2·598		2·187	0·880	0·526	0·000	0·074	0·973	2·598
June	1·451	2·026	2·789		2·317	1·181	0·636	0·391	0·000	0·443	2·789
July	1·640	1·949	2·932		2·655	1·532	0·248	0·000	0·250	0·824	2·932
August	1·414	1·947	2·683		2·073	0·789	0·154	0·000	0·182	0·202	2·683
September	0·486	1·188	2·109		1·508	0·651	0·000	0·358	0·127	0·124	2·109
October	0·248	0·712	1·704		1·507	0·418	0·102	0·045	0·000	0·048	1·704
November	0·073	0·195	0·759	0·811	0·627	0·153	0·091	0·000	0·263	0·367	0·759
December	0·000	0·011	0·507	0·556	0·577	0·556	0·394	0·594	0·672	0·740	0·740
Spring	0·520	0·528	1·274		1·150	0·379	0·000	0·103	0·345	0·467	1·274
Summer	1·424	1·876	2·664		2·277	1·089	0·361	0·021	0·000	0·637	2·664
Autumn	0·630	1·197	2·080		1·611	0·534	0·000	0·049	0·018	0·040	2·080
Winter	0·000	0·070	0·583		0·557	0·228	0·085	0·228	0·388	0·427	0·583
Winter Solstice	0·019	0·000	0·528		0·471	0·140	0·000	0·200	0·300	0·339	0·528
Equinoxes	0·465	0·835	1·728		1·474	0·494	0·000	0·060	0·193	0·286	1·728
Summer Solstice	1·405	1·878	2·653		2·210	0·998	0·293	0·000	0·029	0·513	2·653
The Year	0·543	0·818	1·550		1·298	0·457	0·011	0·000	0·087	0·293	1·550

DIURNAL VARIATIONS OF MAGNETIC DIP.

Spring in the foregoing table consists of the months of February, March, and April. The means for the quarters may be taken as types of the months from which they are obtained.

In winter the diurnal curve is double; it is probably double also in spring; these means only shew portions of a single curve in summer and autumn.

In the mean for the year,—

The maximum of dip occurs about 9^h 30^m A.M., Makerstoun mean time.

The minimum 5^h 0^m P.M.,

In the mean for winter,—

The maximum occurs about 10^h 10^m A.M., Makerstoun mean time.

The minimum occurs before 5^h A.M.,

A secondary minimum occurs about 3^h 10^m P.M.,

A secondary maximum occurs after 9^h P.M.,

Nearly the same periods occur for spring, the minimum at 3^h 10^m P.M. being the principal minimum; the minimum occurs as late as 6^h P.M. in summer.

In order, if possible, to obtain the periods of maxima or minima not shewn in the 9 daily observations, the following table has been formed.

TABLE XXIII.—Diurnal Variation of Magnetic Dip, deduced from Tables XII. and XIX.

Gött. M. T.	Winter Solstice.	Equinoxes.	Summer Solstice.	1842 and 1843.	Gött. M. T.	Winter Solstice.	Equinoxes.	Summer Solstice.	1842 and 1843.
H.					H.				
10	0.499	0.000	0.808	0.040	22	0.735	2.213	2.466	1.410
11	0.514	0.509	0.574	0.137	23	0.877	2.448	2.416	1.518
12	0.484	0.345	0.379	0.008	0	0.955	2.033	2.006	1.270
13	0.125	1.013	0.421	0.126	1	0.733	1.476	1.635	0.886
14	0.354	0.282	0.624	0.025	2	0.450	0.953	0.929	0.383
15	0.207	0.468	0.922	0.138	3	0.238	0.493	0.899	0.148
16	0.264	1.136	0.890	0.371	4	0.240	0.496	0.547	0.033
17	0.324	0.587	1.065	0.263	5	0.235	0.573	0.447	0.024
18	0.054	0.623	1.563	0.351	6	0.248	0.673	0.263	0.000
19	0.000	0.659	1.959	0.478	7	0.457	0.905	0.000	0.060
20	0.182	1.147	2.118	0.754	8	0.307	1.138	0.282	0.183
21	0.360	1.549	2.224	0.982	9	0.389	0.992	0.346	0.184

In winter the principal minimum occurs at 6^h A.M., the secondary maximum about 10^h P.M. The means are too irregular in the other periods to give the times of the secondary maximum and minimum ; in other respects they agree with those in Table XXII.

RANGES OF THE MONTHLY MEANS OF THE DIURNAL VARIATIONS OF MAGNETIC DIP.

The annual variation of the diurnal ranges seems to bear a similar relation to the sun's declination, as the annual variation of atmospheric temperature does to it ; this will be seen distinctly if we place under the ranges of the diurnal variation of magnetic dip the ranges computed on the assumption that one degree of the sun's altitude is equivalent to a diurnal range of 0'05 of dip.

Range.	Jan.	Feb.	March.	April.	May.	June.	July.	Aug.	Sept.	Oct.	Nov.	Dec.
True	0'71	0'62	1'26	2'12	2'60	2'79	2'93	2'68	2'11	1'70	0'76	0'74
Computed	0'69	1'09	1'63	2'21	2'66	2'87	2'78	2'40	1'86	1'28	0'80	0'57

Thus, in the first half of the year, the true range is less than the computed, but in the second it is greater. If this similarity to the *mean* monthly increase of temperature should be found to hold for succeeding years, it is probable that no other connection will be found to exist ; a glance at the mean temperatures for each month in 1843, in the succeeding abstracts, will shew that there is no distinct relation between range and temperature for that year ; there will, however, be evidence of some cause of retardation of the solar influence which produces the diurnal motion of the needle.

The diurnal variation of dip is about 0'7 in winter, and four times as great in summer ; the mean of all the monthly ranges is 1'75, the diurnal range of the mean for the year being 1'55.

TABLE XXIV.—Variations of Magnetic Dip, with reference to the Moon's Age, Declination, and Distance from the Earth, as deduced from Tables IX. and XVI.

Moon's Age.	Variations of Magnetic Dip.	Moon's Age.	Variations of Magnetic Dip.	After Moon farthest North.	Variations of Magnetic Dip.	After Moon farthest North.	Variations of Magnetic Dip.	Before and after Perigee.	Variations of Magnetic Dip.	Before and after Apogee.	Variations of Magnetic Dip.
Days.	'	Days.	'	Days.	'	Days.	'	Days.	'	Days.	'
15	0.393	0	0.061	0	0.178	14	0.157	7	0.115	7	0.263
16	0.187	1	0.131	1	0.189	15	0.187	6	0.179	6	0.326
17	0.298	2	0.052	2	0.164	16	0.251	5	0.273	5	0.161
18	0.140	3	0.144	3	0.154	17	0.200	4	0.438	4	0.223
19	0.210	4	0.072	4	0.392	18	0.134	3	0.312	3	0.142
20	0.159	5	0.036	5	0.374	19	0.080	2	0.166	2	0.179
21	0.103	6	0.237	6	0.340	20	0.046	1	0.245	1	0.136
22	0.083	7	0.263	7	0.251	21	0.184	P	0.204	A	0.240
23	0.211	8	0.221	8	0.127	22	0.085	1	0.155	1	0.000
24	0.053	9	0.309	9	0.164	23	0.143	2	0.181	2	0.115
25	0.168	10	0.347	10	0.260	24	0.121	3	0.214	3	0.136
26	0.083	11	0.307	11	0.000	25	0.142	4	0.154	4	0.204
27	0.000	12	0.205	12	0.136	26	0.200	5	0.103	5	0.192
28	0.111	13	0.300	13	0.147	27	0.172	6	0.029	6	0.089
29	0.150	14	0.167					7	0.167	7	0.092

VARIATIONS OF MAGNETIC DIP, WITH REFERENCE TO THE MOON'S AGE.

A glance at the quantities in the first portion of Table XXIV. will at once shew that the *dip* is a *maximum* when the sun and moon are in *opposition*, and that it is a *minimum* when they are in *conjunction*. This result is perhaps more distinct in the following

Means of Groups.

14 days to 16 days, Full Moon,	0.249	29 days to 1 day, New Moon,	0.114
17 20 ...	0.202	2 5 ...	0.076
21 24 ...	0.112	6 9 ...	0.257
25 28 ...	0.090	10 13 ...	0.290

The maximum of dip occurs in these means rather before full moon, and there is an indication of a secondary maximum at the time of new moon, the minima occurring immediately before and after; this indication of a secondary maximum is probably too indistinct to be trusted.

VARIATIONS OF MAGNETIC DIP, WITH REFERENCE TO THE MOON'S DECLINATION.

Means of Groups.

27 days to 1 day, Moon farthest North,	0.180	13 days to 15 days, Moon farthest South,	0.164
2 5 ...	0.271	16 19 ...	0.166
6 8 ...	0.239	20 22 ...	0.105
9 12 ...	0.140	23 26 ...	0.151

The result from these means does not seem very distinct; on the whole, there seems to be a maximum of dip about the time the moon is on the equator moving southwards, and a minimum about the time it is on the equator moving northwards.

VARIATIONS OF MAGNETIC DIP, WITH REFERENCE TO THE MOON'S DISTANCE FROM THE EARTH.

Means of Groups.

6 days after Apogee to 6 days before Perigee,	0'·119	6 days after Perigee to 6 days before Apogee,	0'·197
5 days to 2 days before Perigee,	0'·297	5 days to 2 days before Apogee,	0'·176
1 day before to 1 day after Perigee,	0'·201	1 day before to 1 day after Apogee,	0'·125
2 days to 5 days after Perigee,	0'·163	2 days to 5 days after Apogee,	0'·162

TOTAL MAGNETIC FORCE.

The following results are deduced from the variations of the horizontal and vertical components by means of the formula

$$\frac{\Delta R}{R} = \frac{\Delta Y}{Y} - \cos^2 \theta \left(\frac{\Delta Y}{Y} - \frac{\Delta X}{X} \right)$$

where $\frac{\Delta R}{R}$ is the quantity in the following tables, $\frac{\Delta Y}{Y}$ and $\frac{\Delta X}{X}$ the quantities in the tables for the vertical and horizontal components respectively, and θ the magnetic dip = 71° 18'.

SECULAR CHANGE OF THE TOTAL MAGNETIC FORCE.

From the mean secular changes for the two components of magnetic force, pages 235 and 245, we obtain

Mean Secular Change of the Total Force, 1842 to 1843, = 0·001587.

ANNUAL PERIOD OF THE TOTAL MAGNETIC FORCE.

From the quantities, pages 231 and 241, exhibiting the annual periods of the two components of magnetic force (the secular change being eliminated), the following quantities have been obtained, which shew the variations of the total magnetic force for the different months of the year.

Jan.	Feb.	March.	April.	May.	June.	July.	Aug.	Sept.	Oct.	Nov.	Dec.
0·000 406	358	127	000	036	257	248	227	058	156	313	395

These quantities indicate *maxima of the total force about the periods of the solstices, and minima about the periods of the equinoxes.* One minimum occurs after the vernal equinox, and the maximum at the winter solstice is greater than that at the summer solstice.

TABLE XXV.—Diurnal Variations of the Total Force of the Earth's Magnetism, deduced from Tables XI. and XVIII.

Period.	18 ^h .	20 ^h .	22 ^h .	23 ^h .	0 ^h .	2 ^h .	4 ^h .	6 ^h .	8 ^h .	10 ^h .	Range.
January	000	052	032	000	058	114	121	150	159	144	000
February	000	078	031		025	069	152	194	219	156	219
March	063	107	063		000	071	187	304	325	206	325
April	034	076	045		000	117	340	658	494	250	658
May	151	168	085		000	119	296	434	471	182	471
June	144	171	070		000	074	247	385	411	309	411
July	057	105	041		000	155	379	450	455	271	455
August	095	136	082		000	194	339	459	417	288	459
September	000	089	048		006	150	278	284	205	081	284

TABLE XXV.—Continued.

Period.	18 ^h .	20 ^h .	22 ^h .	23 ^h .	0 ^h .	2 ^h .	4 ^h .	6 ^h .	8 ^h .	10 ^h .	Range.
October	0 ⁰⁰⁰ 000	0 ⁰⁰⁰ 052	0 ⁰⁰⁰ 035	0 ⁰⁰⁰ 000	0 ⁰⁰⁰ 040	0 ⁰⁰⁰ 167	0 ⁰⁰⁰ 282	0 ⁰⁰⁰ 279	0 ⁰⁰⁰ 206	0 ⁰⁰⁰ 136	0 ⁰⁰⁰ 282
November	000	014	005	-011	009	120	175	150	133	097	175
December	000	016	004	-006	026	086	176	165	196	095	196
Spring	024	079	039		000	078	219	378	339	196	378
Summer	118	148	065		000	116	307	423	446	254	446
Autumn	016	076	040		000	155	285	325	261	153	325
Winter	000	027	014		031	107	157	155	163	112	163
Winter Solstice	000	040	018		029	097	156	165	177	123	177
Equinoxes	013	069	036		000	115	260	370	296	157	370
Summer Solstice	112	145	069		000	135	315	432	438	262	438
The Year	032	075	031		000	106	234	313	294	171	313

DIURNAL VARIATION OF THE TOTAL MAGNETIC FORCE.

Spring, in the foregoing table, consists of the months of February, March, and April. The diurnal curve is double in each month of the year. In the mean for the year,—

The principal maximum occurs about 6^h P.M., Makerstoun mean time.
 A minimum occurs about 11^h 10^m A.M.,
 A secondary maximum occurs about 7^h 10^m A.M.,
 A minimum occurs between 9^h P.M. and 5^h A.M.,.....

These observations do not shew the period of this minimum, nor whether it is secondary or principal.

The principal maximum occurs as late as 7^h P.M. in winter and in summer, and as early as 4^h and 5^h P.M. in some of the months about the equinoxes. The secondary maximum occurs at the same hour, 7^h 10^m A.M., throughout the year. In the winter months, the principal minimum occurs between 9^h 10^m P.M., and 5^h 10^m A.M. The minimum near noon occurs about 9^h 40^m A.M. in mid-winter, and about 11^h 10^m A.M. in mid-summer. The following table has been formed in order to obtain, if possible, the period of the earliest minimum.

TABLE XXVI.—Diurnal Variations of the Total Force of the Earth's Magnetism, deduced from Tables XII. and XIX.

Gött. M. T.	Winter Solstice.	Equinoxes.	Summer Solstice.	Mean.	Gött. M. T.	Winter Solstice.	Equinoxes.	Summer Solstice.	Mean.
H.	0 ⁰⁰⁰	0 ⁰⁰⁰	0 ⁰⁰⁰	0 ⁰⁰⁰	H.	0 ⁰⁰⁰	0 ⁰⁰⁰	0 ⁰⁰⁰	0 ⁰⁰⁰
10	213	600	281	355	22	081	397	168	206
11	152	509	260	298	23	077	375	120	181
12	045	413	177	202	0	102	378	104	186
13	000	010	049	011	1	160	398	133	221
14	029	000	000	000	2	197	443	257	290
15	071	045	006	031	3	214	535	331	351
16	064	014	046	032	4	240	649	389	417
17	044	148	145	103	5	237	698	418	442
18	062	278	169	161	6	216	744	460	464
19	096	382	209	220	7	195	726	503	465
20	090	444	188	231	8	180	622	506	427
21	106	461	188	242	9	168	533	475	383

From this table, the principal minimum occurs about 1^h 10^m A.M. in the mean for the year, about midnight in winter, and about 2^h A.M. at the equinoxes and in summer.

The results from Table XXVI. differ little from those deduced from Table XXV. The secondary maximum occurs earlier in summer than at the other periods, namely, about 6^h A.M. in summer, and about 8^h A.M. in winter and at the solstices. The following are the periods for the year:—

- The principal maximum occurs at 6^h P.M., Makerstoun mean time.
- The principal minimum occurs at 1^h 10^m A.M.,
- A secondary maximum occurs at 8^h A.M.,
- A secondary minimum occurs at 10^h 40^m A.M.,

RANGES OF THE MONTHLY MEANS OF THE DIURNAL VARIATIONS OF THE TOTAL MAGNETIC FORCE.

It is evident, from the previous results, that the quantities in the last column of Table XXV. are not at all the diurnal ranges, as the minimum occurs near midnight. From Table XXVI., however, it appears that the range of the mean diurnal curve for the months about the winter solstice is 0.000240, about the equinoxes is 0.000744, and about the summer solstice is 0.000506; or, that the ranges are nearly in the following ratio:—

$$\text{Winter Solstice : Summer Solstice : Equinoxes} = 1 : 2 : 3.$$

TABLE XXVII.—Variations of the Total Force of the Earth's Magnetism with reference to the Moon's Age, Declination, and Distance from the Earth, as deduced from Tables IX. and XVI.

Moon's Age.	Variations of Magnetic Force.	Moon's Age.	Variations of Magnetic Force.	After Moon farthest North.	Variations of Magnetic Force.	After Moon farthest North.	Variations of Magnetic Force.	Before and After Perigee.	Variations of Magnetic Force.	Before and After Apogee.	Variations of Magnetic Force.
Days.	0.000	Days.	0.000	Days.	0.000	Days.	0.000	Days.	0.000	Days.	0.000
15	037	0	040	0	130	14	073	7	107	7	052
16	058	1	025	1	087	15	057	6	086	6	022
17	073	2	066	2	146	16	033	5	164	5	051
18	064	3	083	3	092	17	005	4	058	4	045
19	048	4	049	4	064	18	033	3	040	3	027
20	082	5	042	5	035	19	017	2	062	2	025
21	087	6	145	6	041	20	027	1	083	1	040
22	071	7	040	7	056	21	009	P	053	A	031
23	076	8	067	8	066	22	015	1	056	1	000
24	073	9	048	9	042	23	028	2	087	2	035
25	095	10	036	10	026	24	000	3	084	3	051
26	084	11	053	11	043	25	060	4	076	4	094
27	049	12	001	12	053	26	037	5	080	5	095
28	154	13	000	13	087	27	085	6	043	6	120
29	058	14	016					7	047	7	101

VARIATIONS OF THE TOTAL MAGNETIC FORCE WITH REFERENCE TO THE MOON'S AGE.

Means of Groups.

14 days to 16 days, Full Moon,	0.000037	29 days to 1 day, New Moon,	0.000041
17 20 ...	0.000067	2 5 ...	0.000060
21 24 ...	0.000077	6 9 ...	0.000075
25 28 ...	0.000095	10 13 ...	0.000022

From these means the total force is a minimum when the sun and moon are in opposition and in conjunction, and a maximum about the quadratures. The principal minimum occurs at the time of full moon.

VARIATIONS OF THE TOTAL MAGNETIC FORCE WITH REFERENCE TO THE MOON'S DECLINATION.

Means of Groups.

27 days to 1 day, Moon farthest North, 0.000101	13 days to 15 days, Moon farthest South, 0.000072
2 5 ... 0.000084	16 19 ... 0.000022
6 8 ... 0.000058	20 22 ... 0.000017
9 12 ... 0.000041	23 26 ... 0.000031

There seem, therefore, to be *maxima of the total magnetic force when the moon has its greatest north and south declinations, and minima about the time when the moon is on the equator.* The principal maximum occurs when the moon has its greatest north declination, and the principal minimum when it is on the equator moving northwards; the secondary maximum and minimum are not shewn so distinctly.

VARIATIONS OF THE TOTAL MAGNETIC FORCE WITH REFERENCE TO THE MOON'S DISTANCE FROM THE EARTH.

Means of Groups.

6 days after Apogee to 6 days before Perigee, 0.000103	6 days after Perigee to 6 days after Apogee, 0.000041
5 days to 2 days before Perigee, 0.000081	5 days to 2 days before Apogee, 0.000037
1 day before to 1 day after Perigee, 0.000064	1 day before to 1 day after Apogee, 0.000024
2 days to 5 days after Perigee, 0.000082	2 days to 5 days after Apogee, 0.000069

EXTREME POSITIONS.

TABLE XXVIII.—Differences of the Extreme Readings of the Three Magnetometers from the Monthly Means for the Hours at which they occurred, for each Month in 1843, as deduced from the Nine Daily Observations, together with the Ranges of the Three Magnetic Elements in each Month.

Month.	Westerly Declination.			Bifilar Magnetometer.				Balance Magnetometer.				Ranges.										
	Greater than Mean.			Less than Mean.			Reading greater than Mean.		Reading less than Mean.		Reading greater than Mean.		Reading less than Mean.		Declination.	Horizontal component.	Vertical component.					
	d.	h.	'	d.	h.	'	d.	h.	Sec. Div.	d.	h.	Sec. Div.	d.	h.	Mic. Div.	d.	h.	Mic. Div.	'			
1843.																						
Jan.	16	2	+ 4.15	23	8	-- 4.64	16	6	+ 9.4	28	8	- 12.9	28	6	+ 85.0	27	18	- 44.5	12.70	0.00239	0.00133	
Feb.	24	4	+ 15.95	6	10	- 36.75	12	20	+ 10.0	14	10	- 14.5	24	8	+ 123.9	13	20	- 47.8	59.29	.00267	.00171	
Mar.	7	4	+ 10.94	29	10	- 15.41	18	6	+ 19.4	7	8	- 24.8	7	8	+ 292.7	31	0	- 52.2	33.02	.00474	.00335	
Apr.	6	2	+ 10.79	6	10	- 12.85	5	6	+ 43.9	5	10	- 68.8	5	6	+ 344.0	5	20	- 105.4	33.38	.01265	.00452	
May	26	2	+ 4.22	6	10	- 18.44	10	6	+ 18.4	6	10	- 79.1	15	10	+ 79.8	6	10	- 257.2	29.84	.01069	.00303	
June	30	2	+ 7.96	29	20	- 6.50	30	6	+ 13.3	11	22	- 10.6	13	6	+ 53.7	4	18	- 38.6	25.60	.00474	.00097	
July	25	2	+ 5.55	24	10	- 26.31	25	4	+ 96.2	24	22	- 42.0	25	4	+ 246.1	0	18	- 56.7	40.48	.01627	.00291	
Aug.	22	2	+ 4.23	4	6	- 8.79	4	6	+ 22.6	8	18	- 36.8	4	6	+ 116.1	8	18	- 153.0	19.86	.00744	.00268	
Sept.	1	20	+ 13.00	18	10	- 9.11	23	6	+ 17.4	18	22	- 16.4	5	6	+ 51.5	27	18	- 46.2	24.90	.00508	.00115	
Oct.	5	0	+ 6.16	26	10	- 17.63	16	10	+ 38.1	4	22	- 9.0	26	6	+ 90.8	4	18	- 63.8	31.39	.00617	.00165	
Nov.	6	0	+ 5.89	3	8	- 4.22	24	2	+ 10.8	3	0	- 10.3	3	2	+ 32.6	2	18	- 20.3	14.20	.00335	.00068	
Dec.	12	2	+ 5.45	11	8	- 11.22	8	20	+ 15.1	8	10	- 18.6	8	8	+ 94.5	10	18	- 46.2	21.82	.00412	.00153	

XXIX.—Differences of the Extreme Readings of the Three Magnetometers from the Monthly Means during the Extra Observations in 1843, together with the Ranges of the Three Magnetic Elements during each of the Observed Disturbances.

Date.	Westerly Declination.				Bifilar Magnetometer.				Balance Magnetometer.				Ranges.		
	Greater than Mean.		Less than Mean.		Reading greater than Mean.		Reading less than Mean.		Reading greater than Mean.		Reading less than Mean.		Declination.	Horizontal component.	Vertical component.
1843.	h.	'	h.	'	h.	Sc. Div.	h.	Sc. Div.	h.	Mic. Div.	h.	Mic. Div.	'	X=I.	Y=I.
Jan. 2	6	+ 0.03	6	-20.42	6	+ 16.9	6	- 6.8	6	+105.6	6	+ 71.0	20.45	0.00242	0.00031
Jan. 11	9	+ 0.14	9	-17.42	9	- 1.4	9	- 32.2	9	+119.4	10	+ 36.3	17.56	.00314	.00076
Feb. 6	8	+ 6.15	10	-36.75	10	+ 1.3	10	- 22.9	10	+ 77.4	11	+ 12.6	45.81	.00247	.00059
Feb. 13	11	+ 1.59	10	-13.58	11	+ 2.6	10	- 11.0	10	+ 12.8	11	+ 7.0	15.17	.00135	.00006
Feb. 14	10	+ 1.61	9	-17.22	9	+ 27.9	10	- 14.5	8	+ 20.3	9	- 24.5	17.38	.00438	.00043
Feb. 16	6	+ 1.42	8	-13.49	8	+ 11.4	8	- 8.5	8	+ 7.8	6	- 5.8	16.86	.00203	.00014
Feb. 23	20	- 22.5	25.70	.00438	.00169
Feb. 24	4	+16.03	9	- 4.53	5	+ 19.9	8	- 22.5	7	+148.3
Feb. 25	11	+ 2.38	10	-12.66	10	+ 29.9	11	- 28.7	11	- 3.5	10	- 27.8	15.04	.00602	.00021
Mar. 4	11	+ 1.38	11	- 8.78	11	+ 5.3	12	- 11.2	10	+ 34.4	11	+ 3.5	10.16	.00169	.00030
Mar. 6	14	+11.24	11	-17.77	14	+ 29.8	17	- 40.4	9	+ 37.7	17	-128.3	29.41	.00708	.00168
Mar. 7	4	+10.94	8	- 8.49	5	+ 20.3	8	- 27.6	8	+292.7	0	+ 31.1	23.90	.00510	.00260
Mar. 9	8	+ 1.87	7	- 2.68	6	+ 2.2	7	- 16.3	7	+ 51.0	6	+ 20.3	4.01	.00200	.00030
Mar. 10	9	+ 2.01	8	- 2.95	8	+ 23.5	10	- 0.3	10	+ 14.6	8	- 10.4	3.86	.00254	.00010
Mar. 11	8	- 2.24	10	- 8.04	9	+ 16.1	9	- 19.9	10	+ 13.6	9	- 16.4	8.00	.00367	.00021
Mar. 12	13	+ 8.02	7	-39.59	5	+ 19.6	14	- 45.6	7	+ 37.3	14	-211.7	45.02	.00731	.00519
Mar. 18	3	+ 8.13	6	-11.23	6	+ 32.1	0	- 1.0	6	+ 51.0	2	- 6.5	23.37	.00465	.00072
Mar. 21	8	+ 1.96	9	- 8.03	8	+ 22.6	9	- 2.4	8	- 24.1	9	- 33.2	11.09	.00260	.00014
Mar. 22	3	+ 7.80	0	+ 1.82	3	+ 19.8	0	- 7.6	4	- 1.3	1	- 25.7	7.98	.00383	.00029
Mar. 29	6	+ 2.24	11	-20.76	10	+ 18.2	11	- 31.1	7	+123.9	10	-142.5	26.29	.00506	.00249
Apr. 5	7	+35.43	11	-25.84	5	+151.0	13	-125.7	6	+517.8	13	-259.1	63.01	.02927	.00755
Apr. 6	3	+13.32	10	-16.93	4	+ 18.3	14	-115.6	3	+157.4	14	-386.8	38.58	.01445	.00507
Apr. 7	18	+ 3.44	8	-18.74	8	+ 44.1	9	- 12.9	6	+ 43.5	18	- 36.2	21.22	.00609	.00125
Apr. 8	4	+ 0.87	5	-10.45	6	+ 12.8	7	- 4.2	6	+ 63.5	4	+ 28.0	13.48	.00203	.00062
Apr. 12	6	+ 9.48	9	-15.00	6	+ 17.9	9	- 14.9	7	+111.1	2	+ 6.7	26.66	.00423	.00134
Apr. 13	20	+ 4.78	18	+ 0.35	20	+ 5.9	19	- 24.3	18	+ 15.0	19	- 51.9	3.74	.00303	.00057
Apr. 18	6	+ 1.66	7	-12.61	7	+ 16.2	7	- 1.1	7	+ 98.1	8	+ 22.7	15.14	.00177	.00073
May 6	12	+12.85	12	-90.29	8	+ 5.4	11	-417.0	11	+316.4	11	-685.5	103.14	.04278	.00902
May 7	11	+10.01	14	- 8.04	11	- 38.3	13	- 52.2	11	- 71.0	14	-154.3	18.70	.00155	.00081
May 10	2	+ 0.44	6	- 8.02	6	+ 33.2	3	- 25.9	7	+ 40.6	2	+ 14.9	13.63	.00665	.00048
May 15	8	+ 0.28	9	-10.95	8	+ 21.1	9	- 13.0	9	+175.6	8	+ 21.6	11.78	.00389	.00129
June 2	22	+11.46	20	- 4.77	20	- 1.9	21	- 43.6	21	- 1.0	22	- 42.2	19.06	.00449	.00038
June 7	10	+ 7.35	11	-11.97	11	+ 15.5	12	- 28.1	10	- 26.6	12	- 90.0	19.32	.00429	.00060
June 13	7	+ 0.88	6	- 3.48	7	+ 25.2	6	- 19.7	6	+ 53.7	8	+ 20.1	3.95	.00461	.00032
June 30	18	+ 3.45	20	- 4.16	20	+ 0.2	21	- 16.2	21	- 12.7	18	- 80.0	8.74	.00200	.00098
July 1	6	+ 3.49	8	- 4.28	8	+ 28.3	9	- 7.8	8	+ 13.8	6	+ 2.0	9.44	.00389	.00014
July 4	8	+ 3.67	9	- 8.64	9	+ 22.8	10	+ 5.5	9	+ 10.8	10	+ 13.7	12.34	.00205	.00004
July 24	7	+ 1.64	10	-29.20	6	+ 51.4	10	- 32.0	9	+ 51.1	10	- 60.1	33.73	.00912	.00106
July 24	22	- 50.1
July 25	5	+29.61	11	-10.87	3	+121.5	11	- 80.3	3	+321.4	11	-129.4	45.49	.00199	.00409
Aug. 3	4	+ 2.93	6	- 1.39	4	+ 22.2	6	- 2.0	6	- 19.4	4	- 39.6	8.00	.00222	.00030
Aug. 3	22	- 20.7	6	+133.2	0	- 23.0	23.66	.00696	.00169
Aug. 4	1	+ 6.75	6	-11.23	6	+ 22.6
Aug. 8	18	+24.00	20	+ 1.01	19	+ 16.6	18	- 42.0	22	- 36.1	19	-211.8	24.31	.00557	.00166
Aug. 22	1	+12.74	6	+ 4.47	3	+ 28.0	1	- 20.8	6	+ 74.9	5	- 36.8	13.95	.00581	.00106
Sept. 1	3	+ 7.40	6	- 4.17	5	+ 21.4	4	- 21.7	16.50	.00409	...
Sept. 1	20	+13.00	20	- 22.2	12.19	.00390	...
Sept. 2	6	- 0.93	4	+ 5.0
Sept. 18	12	+10.10	10	-12.48	11	+ 30.7	12	- 21.4	10	- 14.2	12	-100.6	22.58	.00514	.00083
Sept. 19	10	+ 6.60	7	-14.10	11	+ 28.9	10	- 8.2	7	+ 32.7	11	- 58.3	17.33	.00361	.00102
Oct. 4	23	+ 8.77	23	+ 3.1	30.13	.00664	.00096
Oct. 5	8	-17.92	8	+ 24.7	6	+ 26.8	0	- 69.6
Oct. 16	10	+ 3.86	10	- 6.41	10	+ 38.1	10	+ 2.8	10	+ 14.9	11	- 1.6	10.27	.00348	.00017
Oct. 17	4	+ 1.18	2	- 9.94	4	- 3.7	2	- 15.8	2	+ 80.2	3	+ 49.6	8.59	.00159	.00023
Oct. 26	4	- 1.15	10	-18.10	7	+ 19.4	7	- 14.1	6	+ 90.8	11	+ 3.5	22.32	.00330	.00095
Nov. 2	12	+ 0.23	11	-14.45	11	+ 7.9	11	- 32.1	10	+ 16.2	12	- 88.8	14.73	.00394	.00096
Nov. 3	1	+ 5.57	8	- 4.22	8	+ 3.9	0	- 10.3	2	+ 32.6	23	+ 1.9	13.90	.00237	.00035
Dec. 6	8	+ 2.10	8	- 7.18	8	+ 2.9	10	- 10.8	9	+ 12.0	11	- 22.2	9.28	.00153	.00038
Dec. 8	9	+ 8.70	9	-22.07	6	- 4.2	9	- 46.5	8	+ 1.5	10	- 3.9	30.77	.00461	.00104
Dec. 11	7	+ 7.85	8	-11.22	11	+ 23.4	12	- 5.0	6	+ 21.3	12	- 61.0	20.30	.00302	.00082
Dec. 12	2	+ 6.97	6	- 9.55	7	+ 8.3	2	- 20.9	4	+ 39.3	10	- 16.8	19.21	.00312	.00055
Dec. 13	10	+ 4.59	8	- 3.65	10	+ 5.7	8	- 9.7	8	+ 28.0	10	+ 0.7	7.66	.00148	.00034
Dec. 27	23	+ 3.0	23	- 2.1
Dec. 28	3	+ 9.12	4	+ 0.21	2	- 13.9	4	+ 33.2	9.59	.00170	.00018

TABLE XXX.—Differences of the Extreme Readings of the Three Magnetometers from the Monthly Means, for the Hours at which the Extreme Readings occurred during the Term-Day Observations in 1843, together with the Ranges of the Three Magnetic Elements during each Term-Day.

Date.	Westerly Declination.				Bifilar Magnetometer.				Balance Magnetometer.				Ranges.		
	Greater than Mean.		Less than Mean.		Reading greater than Mean.		Reading less than Mean.		Reading greater than Mean.		Reading less than Mean.		Declination.	Hor. Comp. of Force.	Ver. Comp. of Force.
1843.	h.	'	h.	'	h.	Sc. Div.	h.	Sc. Div.	h.	Mic. Div.	h.	Mic. Div.	'	X=1.	Y=1.
Jan. 18, 19	1	+ 4.05	11	- 5.32	12	+ 9.6	0	- 6.5	10	+ 7.1	20	- 15.0	13.59	0.00194	0.00031
Feb. 24, 25	11	+ 16.00	13	- 7.35	11	+ 7.3	12	- 41.3	11	+ 30.9	13	- 101.6	23.91	.00501	.00124
Mar. 22, 23	1	+ 4.61	7	- 11.42	13	+ 26.8	13	- 8.8	7	+ 8.1	14	- 86.3	19.90	.00363	.00114
Apr. 19, 20	2	- 1.91	21	- 3.39	7	+ 4.1	0	- 2.0	8	- 8.6	2	- 0.7	10.95	.00263	.00028
May 26, 27	2	+ 0.26	10	- 15.30	10	+ 20.5	22	- 13.9	9	+ 7.0	10	- 88.3	22.74	.00489	.00096
June 21, 22	7	+ 3.8	19	- 3.7	20	+ 0.5	0	- 18.400231	.00031
July 19, 20	1	- 0.77	20	- 2.95	8	- 1.3	0	- 1.0	21	+ 9.6	1	- 5.8	10.69	.00249	.00017
Aug. 25, 26	1	+ 2.19	9	- 6.08	9	+ 7.2	23	- 7.2	5	+ 28.9	16	- 28.1	15.17	.00388	.00063
Sept. 20, 21	14	+ 6.46	7	- 16.55	5	+ 11.3	23	- 8.9	7	+ 16.8	15	- 148.5	31.00	.00396	.00176
Oct. 18, 19	16	+ 9.33	9	- 6.68	16	+ 21.0	22	+ 4.6	22	+ 1.9	16	- 117.7	16.80	.00283	.00127
Nov. 24, 25	13	+ 4.89	12	- 1.14	10	+ 14.0	0	0.0	5	+ 12.0	16	- 7.2	6.03	.00170	.00032
Dec. 20, 21	2	- 1.34	10	- 6.84	12	+ 12.1	8	- 2.0	3	+ 1.5	10	- 21.3	11.23	.00124	.00021

When the hours at which the extreme positions occur are between 10^h Gött. and 18^h Gött., approximate means have been taken, in order to deduce the differences between the extreme position and the mean position.

The differences of the greatest and least readings *in the year* from the monthly means for the hours at which the extremes occurred, together with the ranges for the year, are as follow :—

From the Daily Observations.

West Declination, greatest, Feb. 24^d 4^h, +15'95; least, Feb. 6^d 10^h, -36'75; Range of Declination =59'29.

Bifilar Magnetometer Reading, greatest, July 25^d 4^h, +96.2 Sc. div.; least, May 6^d 10^h, -79.1 Sc. div.; Range of Hor. comp. =0.01839.

Balance Magnetometer Reading, greatest, April 5^d 6^h, +344.0 Mic. div.; least, May 6^d 10^h, -257.2 Mic. div.; Range of Ver. comp. =0.00599.

From the Extra Observations, and from all the Observations.

West Declination, greatest, April 5^d 7^h, +35'43; least, May 6^d 12^h, -90'29; Range of Declination =126'91.

Bifilar Magnetometer Reading, greatest, April 5^d 5^h, +151.0 Sc. div.; least, May 6^d 11^h, -417.0 Sc. div.; Range of Hor. comp. =0.05678.

Balance Magnetometer Reading, greatest, April 5^d 6^h, +517.8 Mic. div.; least, May 6^d 11^h, -685.5 Mic. div.; Range of Ver. comp. =0.01141.

From the Term-Day Observations.

West Declination, greatest, Feb. 24^d 11^h, +16'00; least, Sept. 21^d 7^h, -16'55; Range of Declination =32'98.

Bifilar Magnetometer Reading, greatest, Oct. 18^d 16^h, +21.0 Sc. div.; least, Feb. 24^d 12^h, -41.3 Sc. div.; Range of Hor. comp. =0.00789.

Balance Magnetometer Reading, greatest, Feb. 24^d 11^h, +30.9 Mic. div.; least, Sept. 20^d 15^h, -148.5 Mic. div.; Range of Ver. comp. =0.00321.

TABLE XXXI.—Means of the Quantities in the three preceding Tables for periods of Three Months, and for the Year 1843, with the Mean Positive and Negative Excesses of the Excursions of the Magnets.

Observations.	Period.	West Declination.			Bifilar Magnetometer.			Balance Magnetometer.			Ranges.		
		Above Mean.	Below Mean.	Excess.	Above Mean.	Below Mean.	Excess.	Above Mean.	Below Mean.	Excess.	Declination.	Hor. Comp.	Ver. Comp.
Daily	Spring	12.54	21.67	- 9.13	24.4	36.0	- 11.6	253.7	68.5	+ 185.2	41.90	0.00669	0.00319
	Summer	5.91	17.08	- 11.17	42.6	43.9	- 1.3	126.5	117.5	+ 9.0	31.97	0.01057	0.00230
	Autumn	7.80	11.84	- 4.04	26.0	20.7	+ 5.3	86.1	87.7	- 1.6	25.38	0.00623	0.00183
	Winter	5.16	6.69	- 1.53	11.8	13.9	- 2.1	70.7	37.0	+ 33.7	16.24	0.00329	0.00118
	The Year	7.86	14.32	- 6.46	26.2	28.6	- 2.4	134.2	77.6	+ 56.6	28.87	0.00669	0.00212
Term-Day.	Spring	6.23	7.39	- 1.16	12.7	17.4	- 4.7	10.1	62.9	- 52.8	18.25	0.00376	0.00089
	Summer	- 0.25	9.12	- 9.37	7.7	6.2	+ 1.5	5.7	37.5	- 31.8	16.71	0.00323	0.00048
	Autumn	5.99	9.77	- 3.78	13.2	3.8	+ 9.4	15.9	98.1	- 82.2	20.99	0.00356	0.00122
	Winter	2.53	4.43	- 1.90	11.9	2.8	+ 9.1	6.9	14.5	- 7.6	10.28	0.00163	0.00028
	The Year	3.98	7.55	- 3.57	11.4	7.5	+ 3.9	9.6	53.2	- 43.6	16.55	0.00304	0.00072
Extra.	Spring	6.31	13.50	- 7.19	23.7	25.4	- 1.7	79.2	52.4	+ 26.8	21.29	0.00529	0.00143
	Summer	7.09	16.22	- 11.13	23.7	60.9	- 37.2	72.7	97.4	- 24.7	24.94	0.00728	0.00158
	Autumn	8.01	7.60	+ 0.41	21.2	15.3	+ 5.9	38.4	48.8	- 10.4	17.49	0.00436	0.00089
	Winter	4.53	11.00	- 6.47	6.6	18.8	- 11.2	40.9	8.5	+ 32.4	16.34	0.00273	0.00060
	The Year	6.52	12.41	- 5.88	20.2	29.5	- 9.3	63.7	53.6	+ 10.1	20.40	0.00507	0.00121

The foregoing Table has been formed from the three preceding it by taking the means of the excesses or defects, and ranges, for periods of three months.

The extremes, given in Tables XXVIII. and XXIX., are evidently imperfect, as the observations include only a limited portion of the 24 hours; the conclusions to be drawn from the previous Table must, therefore, be very restricted.

From all the observations, the excursions of the declination-needle towards the east are shewn to exceed those towards the west; they all agree also in making this excess greatest in Summer.

The results of the horizontal component differ in the three kinds of observations; on the whole, the deviations from the mean seem to be more negative than positive.

For the vertical component, it has already been shewn that no result for ranges can be trusted that does not include observations between midnight and sunrise. The term-day observations which include the 24 hours give the excess negative; and although the number of days from which this result is obtained are few, yet it is true for 9 out of the 12 term-days, and for the remaining 3 the positive excess is very trifling.

TABLE XXXII.—Differences of the greatest and least Daily Means of Magnetic Declination, and of the Horizontal and Vertical Components of Magnetic Force, from the Monthly Means for each Month in 1843, together with the Monthly Ranges of the Daily Means.

Month.	Westerly Declination.				Horizontal Component.				Vertical Component.				Ranges.		
	Day.	Above Mean.	Day.	Below Mean.	Day.	Above Mean.	Day.	Below Mean.	Day.	Above Mean.	Day.	Below Mean.	Declination.	Hor. Comp.	Ver. Comp.
January	20	3.34	12	2.27	16	0.614	23	0.423	11	0.200	23	0.240	5.61	1037	0.440
February	24	3.28	6	4.07	4	0.628	14	0.511	24	0.223	28	0.107	7.35	1139	0.330
March	7	3.50	29	2.61	22	0.528	16	0.542	7	0.663	31	0.432	6.11	1070	1.095
April	6	3.54	20	1.72	29	0.453	6	0.814	5	0.527	25	0.197	5.26	1267	0.724
May	30	2.11	6	1.97	29	0.952	8	1.391	12	0.139	6	0.266	4.08	2343	0.405
June	14	2.95	20	4.24	10	0.596	8	0.491	17	0.199	22	0.114	7.19	1087	0.313
July	8	3.23	24	3.62	24	1.176	26	0.801	25	0.744	27	0.205	6.85	1977	0.949
August	22	3.63	24	1.79	3	0.689	9	0.803	22	0.487	9	0.406	5.42	1492	0.893
September	28	3.11	21	1.70	18	0.637	5	0.527	11	0.147	30	0.264	4.81	1164	0.411
October	3	2.51	19	3.20	19	0.518	2	0.543	17	0.377	7	0.442	5.71	1061	0.819
November	6	2.99	30	2.30	24	0.741	8	0.734	15	0.156	22	0.144	5.29	1475	0.300
December	6	1.87	1	2.11	25	0.465	8	0.519	2	0.163	25	0.120	3.98	0984	0.283
The Year	Jan. 20	6.50	Nov. 30	5.53	Dec. 25	2.048	Apr. 6	1.776	Jan. 11	1.205	Dec. 25	0.848	12.03	3824	2.053

The last line in the above Table contains the difference of the greatest and least daily means from the mean for the year.

Westerly Declination.—In opposition to the result obtained for the single observations, Table XXXI., the daily means deviate farther to the west of the mean than to the east of it.

The mean of the greatest daily means in each month is 3'00 above the mean.

The mean of the least daily means in each month is 2'63 below the mean.

The greatest deviation of a daily mean to the west of the mean for the month is 3'63, occurring on August 22; the greatest deviation of a daily mean to the east of the monthly mean occurs on June 24, being 4'24.

The greatest deviation of a weekly mean, as given Table I., to the west of the mean for the year, is 4'11, occurring January 19—25; the greatest deviation of a weekly mean to the east of the mean for the year occurs December 21—27, being 4'30.

The greatest range of the daily means for any month is that for February, being 7'35; the least is that for December, being 3'98. The whole range of the daily means for the year is 12'03.

Horizontal Component.—The mean of the greatest daily means in each month is 0.000666 above the monthly means, the whole horizontal component being unity; the mean of the least daily means in each month is 0.000675 below the monthly means.

The greatest excess of a daily mean above the monthly mean is 0.001176, occurring July 24; the greatest defect of a daily mean from the monthly mean occurs May 8, being 0.001391. The greatest excess of a weekly mean, as given Table VIII., above the mean for the year, occurs December 21—27, being 0.004500; and the greatest defect of a weekly mean from the mean for the year occurs April 6—12, being 0.001304.

The greatest range of the daily means for any month is that for May, being 0.002343; the least is that for December, being 0.000984. The range of the daily means for the whole year is 0.003824.

Vertical Component.—The mean of the greatest daily means in each month is 0.000335 above the monthly means, the whole vertical component being unity. The mean of the least daily means in each month is 0.000245 below the monthly means.

The greatest excess of a daily mean above a monthly mean is that for July 25, being 0.000744; the greatest defect of a daily mean from a monthly mean is that for March 31, being 0.000432 below the mean for the month.

The greatest excess of a weekly mean, as given Table XV., above the mean for the year, occurs January 5—11, being 0.001056; the greatest defect of a weekly mean from the mean for the year occurs December 21—27, being 0.000792.

The greatest range of the daily means for any month is that for March, being 0.001095; the least is that for December, being 0.000283. The whole range of the daily means for the year is 0.002053.

TABLE XXXIII.—Greatest and Least Diurnal Ranges of the Magnetic Declination, Horizontal and Vertical Components of Magnetic Force, for each Month in 1843, as obtained from Tables VI., XIII., and XX.

Month.	Declination.				Horizontal Component.				Vertical Component.			
	Day.	Greatest Range.	Day.	Least Range.	Day.	Greatest Range.	Day.	Least Range.	Day.	Greatest Range.	Day.	Least Range.
January	28	11.85	5	3.40	9	0227	7	0029	28	1331	20	0059
February	6	49.03	1	3.19	24	0210	2	0045	24	1483	2	0099
March	29	25.78	1	3.60	7	0346	1	0046	7	3300	28	0103
April	6	33.38	22	5.30	5	1265	22	0144	5	3738	22	0145
May	6	25.50	13	6.36	6	0939	13	0170	6	2713	12	0145
June	30	25.60	19	7.00	12	0417	22	0187	13	0691	9	0139
July	24	32.85	6	7.63	25	1627	22	0173	25	2258	12	0129
August	4	19.10	5	7.16	4	0696	16	0196	4	1536	16	0142
September	18	21.83	30	7.07	9	0405	15	0132	22	0896	27	0226
October	26	25.14	10	3.55	16	0567	21	0130	5	1011	28	0130
November	3	12.74	27	2.68	3	0237	22	0042	3	0681	11	0105
December	11	17.39	16	2.97	11	0305	19	0028	8	1177	16	0083

INCLINOMETER.

TABLE XXXIV.—Monthly Means of the Observations of the Inclinator for the Magnetic Dip.

Month.	No. of Observations.		Magnetic Dip.		
	A. M.	P. M.	23 ^h Göttingen.	4 ^h Göttingen.	Mean of all.
1843.			° /	° /	° /
January	5	4	71 20.94	71 21.69	71 21.27
February	4	3	71 23.17	71 21.90	71 22.62
March	2	5	71 21.46	71 22.29	71 22.04
April	4	3	71 21.76	71 22.85	71 22.23
May	2	4	71 22.40	71 22.57	71 22.52
June	5	5	71 23.67	71 23.65	71 23.66
July	3	4	71 25.64	71 29.50	71 27.85
August	4	5	71 23.67	71 19.53	71 21.37
September	1	2	71 25.94	71 21.43	71 22.94
October	2	2	71 30.40	71 27.06	71 28.73
November	2	4	71 25.58	71 26.20	71 25.99
December	4	5	71 25.32	71 26.27	71 25.85
The Year	38	46	71 23.72	71 23.69	71 23.70

The inclinometer worked very imperfectly after the month of June, see Introduction, § 8. No correction has been applied for the error of axle, as in the previous year, when a correction of $-12'$ was made.

The mean magnetic dip for the first six months of 1842, uncorrected, was $71^{\circ} 24.39'$
 1843, is $71^{\circ} 22.39'$
 the year 1842, was $71^{\circ} 23.95'$
 1843, is $71^{\circ} 23.70'$



ABSTRACTS OF THE RESULTS
OF THE
METEOROLOGICAL OBSERVATIONS,
MADE AT THE OBSERVATORY OF
GENERAL SIR T. M. BRISBANE, BART.,
MAKERSTOUN.
1843.

In the following Tables, containing Daily Means, the places of the Sundays are occupied, as in the previous Tables of Magnetical Observations, by the means of the three preceding and three succeeding days; these means are considered as approximate weekly means, and have *not* been used in summations as approximate means for the Sundays.

Different methods have been adopted in order to obtain good approximate daily means from the nine daily observations; these will be found described after the various Tables. Means obtained by these methods have been compared with the actual means where a complete series of two-hourly observations has been made, and they have been found to differ very little.

In the following Tables, Spring has been considered as composed of the months of March, April, and May, and so on for the other seasons.

TABLE I.—Daily, Weekly, and Monthly Means of the Temperature of the Air, as deduced from the Readings of the Dry Bulb Thermometer for 1843.

Civil Day.	January.	February.	March.	April.	May.	June.	July.	August.	September.	October.	November.	December.
1	[.....]	40.6	31.2	49.4	47.4	46.8	56.9	55.9	61.0	[50.9]	32.7	31.8
2	32.2	35.8	32.7	[45.5]	43.7	50.2	[57.0]	57.2	64.4	51.5	37.6	40.7
3	30.1	29.2	34.3	47.4	47.2	45.0	59.9	58.0	[59.1]	52.0	36.7	[42.3]
4	39.8	34.3	30.1	44.9	50.5	[47.4]	57.9	57.5	55.3	56.6	47.6	49.0
5	35.6	[35.2]	[34.7]	44.2	44.6	42.7	58.9	55.7	54.0	56.8	[41.2]	46.1
6	36.8	32.8	41.3	45.1	45.8	47.6	57.8	[57.6]	62.7	57.2	46.7	43.5
7	39.6	39.6	38.9	45.1	[46.2]	52.3	57.0	57.0	56.8	54.3	42.9	49.0
8	[35.4]	39.8	30.9	40.7	44.9	54.0	56.2	60.0	58.6	[49.2]	35.8	46.1
9	35.3	35.9	34.4	[38.8]	47.1	52.9	[57.2]	57.7	59.9	43.8	32.8	45.5
10	32.9	35.2	35.5	34.1	44.3	54.3	58.6	55.5	[58.1]	41.9	38.1	[46.6]
11	32.5	36.6	41.7	33.6	47.1	[51.7]	57.0	58.6	60.2	41.4	43.9	46.2
12	24.4	[31.4]	[37.5]	34.0	50.0	48.0	56.6	59.5	59.9	39.6	[37.7]	46.4
13	34.2	31.9	39.5	35.4	52.5	47.2	58.6	[58.3]	53.5	35.6	39.4	46.2
14	31.5	25.4	37.5	50.7	[47.6]	53.8	57.6	57.7	54.6	35.8	34.8	48.4
15	[35.1]	23.7	36.7	48.3	46.9	57.6	60.1	57.9	58.5	[35.4]	37.4	47.6
16	36.8	24.8	38.5	[47.8]	44.9	57.3	[57.0]	60.9	57.6	32.7	36.7	39.7
17	39.0	25.2	45.2	50.4	44.2	52.0	56.4	63.3	[56.4]	35.7	44.6	[45.0]
18	45.0	18.6	46.8	48.9	42.7	[54.6]	57.1	64.0	57.3	32.9	37.1	44.2
19	45.1	[29.3]	[44.7]	53.3	43.3	48.2	52.3	65.2	51.9	33.9	[40.5]	43.2
20	39.5	35.2	41.5	47.1	47.0	55.0	51.7	[58.8]	58.4	46.1	40.4	46.9
21	31.5	35.4	46.2	52.8	[45.0]	57.7	54.7	53.3	58.1	45.8	42.2	40.9
22	[41.3]	36.4	49.9	47.7	44.8	56.9	55.2	54.7	53.0	[42.3]	42.2	48.9
23	40.6	36.0	47.6	[46.2]	46.1	56.7	[55.6]	52.1	55.1	49.5	35.7	49.8
24	45.7	37.1	42.0	45.7	46.0	54.8	54.4	53.0	[51.0]	40.9	31.1	[46.5]
25	45.2	34.3	41.0	44.1	48.4	[53.3]	56.1	56.9	47.5	37.4	30.8	49.4
26	45.3	[34.5]	[39.0]	39.8	51.5	52.3	61.5	54.1	48.1	33.8	[39.5]	46.4
27	51.1	34.7	33.2	44.8	50.2	50.3	56.9	[54.4]	44.1	34.6	48.9	43.9
28	46.0	33.5	36.0	43.7	[47.5]	48.8	54.8	56.5	44.1	42.3	48.5	44.5
29	[45.6]	34.0	43.8	42.6	52.7	57.2	54.4	44.2	[35.1]	42.3	46.2	44.6
30	45.1	39.1	[45.1]	47.0	55.9	[54.8]	51.8	57.1	33.9	42.8	44.6	[37.5]
31	45.8	48.1										
Mean	38.7	33.0	39.0	44.6	46.5	52.0	56.8	57.3	55.2	42.3	39.6	45.2

The daily means, T, contained in Table I., were obtained from the nine daily observations as follows:—S being the sum of the nine observations, 18 the observation at 18^h, 10 at 10^h, then

$$T = \frac{S + 2 \times 18 + 10}{12}.$$

For the first week in January, the mean of the observations at 20^h and 5^h was taken for the mean of the day; and the second week, S being the sum of eight observations only, 3×20 was substituted for 2×18 in the previous formula.

TABLE II.—Means of the Maximum and Minimum Temperature of the Air for each Day in 1843, as deduced from the Self-Registering Thermometers.

Civil Day.	January.	February.	March.	April.	May.	June.	July.	August.	September.	October.	November.	December.
1	33.0	41.1	31.8	51.5	46.2	45.7	55.8	56.4	62.1	59.7	35.1	34.6
2	32.0	39.0	32.6	52.5	44.8	56.3	57.9	59.3	64.9	53.9	37.4	36.7
3	32.8	32.3	33.9	50.2	48.3	46.2	61.3	59.7	64.3	48.5	36.6	44.2
4	39.0?	29.9	30.7	44.4	50.1	45.3	56.7	59.0	56.4	56.4	44.3	48.5
5	35.5	32.1	36.7	45.8	46.1	43.3	59.5	56.1	52.7	58.6	38.9	49.4
6	37.5	33.0	42.4	44.7	47.2	46.8	59.8	55.5	61.6	58.7	43.1	42.3
7	37.5	38.2	40.5	45.8	49.3	52.2	56.7	54.6	56.2	55.9	44.6	48.1
8	31.5	40.6	32.6	41.9	45.3	54.2	57.0	63.2	58.7	48.9	37.6	45.9
9	31.9	34.5	39.1	47.1	53.0	58.2	60.8	62.0	44.4	33.1	45.2
10	35.3	34.7	38.1	35.1	44.4	55.8	58.9	54.5	58.7	44.8	37.1	44.4
11	33.2	35.5	41.7	35.7	48.4	51.9	59.7	57.0	62.6	40.5	43.0	47.2
12	26.1	37.6	47.2	35.0	47.8	50.6	56.3	59.6	64.3	41.7	38.2	44.9
13	29.2	32.9	40.0	34.2	54.0	47.6	59.3	61.3	55.4	36.8	42.8	46.8
14	34.8	26.9	37.8	45.3	54.6	52.0	57.8	57.0	51.6	39.4	35.8	47.1
15	23.3	38.3	50.5	45.8	56.2	60.0	56.5	61.1	34.8	37.1	50.7
16	26.7	37.3	50.5	45.2	54.0	59.3	63.4	59.7	34.1	37.0	37.8
17	37.2	26.6	44.3	52.1	44.7	51.9	55.2	66.0	58.8	35.6	43.7	43.8
18	43.2	21.6	51.5	49.0	44.3	51.8	58.4	65.1	57.3	35.2	37.1	42.2
19	44.3	28.0	46.9	55.5	40.9	48.9	54.1	65.4	51.8	33.3	38.0	44.0
20	43.2	33.6	44.7	46.4	49.0	56.7	51.0	58.2	57.7	43.3	40.5	45.2
21	35.1	34.3	47.8	50.5	45.1	57.8	55.8	52.2	61.0	48.8	43.5	42.2
22	35.7	36.0	50.7	48.9	45.3	56.3	54.9	56.6	54.0	48.4	42.8	45.0
23	40.0	36.3	50.3	45.1	46.2	59.0	51.7	51.3	55.0	49.3	33.9	49.1
24	45.0	37.3	40.6	44.3	47.7	53.1	51.1	53.2	57.1	45.9	31.9	52.2
25	45.3	35.7	43.9	45.8	47.8	51.6	52.0	56.9	48.3	39.2	32.4	48.1
26	45.3	36.0	40.0	42.9	51.1	53.7	60.6	56.0	46.5	37.1	39.5	48.0
27	49.0	35.9	34.1	44.8	51.7	48.7	58.3	53.4	44.3	34.3	49.4	44.0
28	47.5	36.0	38.2	46.4	46.0	49.6	57.9	54.6	44.7	41.9	48.9	43.7
29	48.0		35.9	43.7	43.1	51.9	59.0	56.4	42.4	41.7	45.8	46.0
30	47.0		38.5	49.2	47.3	53.9	57.6	52.5	55.5	32.1	39.2	45.0
31	46.5		50.5		45.3		59.2	59.6		36.2		44.6
Mean	38.7	33.4	40.5	45.6	47.1	51.9	57.1	57.8	56.2	43.9	39.6	45.1

Annual Variation of Temperature.—The mean temperature is least for the month of February and greatest for the month of August; the means for April, May, and December differ little from the mean for the year. The monthly means differ slightly in Tables I. and II.; one cause of this difference will evidently be found in the means for Sundays, included in Table II.; when these means are deleted, the monthly means from the self-registering thermometers are as follow:—

Jan.	Feb.	March.	April.	May.	June.	July.	August.	Sept.	Oct.	Nov.	Dec.
39°·0	33°·4	40°·2	45°·3	46°·9	52°·1	57°·1	57°·9	55°·7	43°·4	39°·8	44°·9

These quantities differ from the means, Table I., from the observations of the dry bulb thermometer by

Jan.	Feb.	March.	April.	May.	June.	July.	August.	Sept.	Oct.	Nov.	Dec.
+0°·3	+0°·4	+1°·2	+0°·7	+0°·4	+0°·1	+0°·3	+0°·6	+0°·5	+1°·1	+0°·2	−0°·3

These differences evidently have a law, the amount being greatest near the equinoxes and least near the solstices.*

* These differences and their variations are probably due to three causes; *first*, difference of exposure of the register and dry bulb thermometers; *second*, difference in the form of the diurnal curve for the various months; *third*, less conducting power of the spirit of wine of the minimum thermometer than of the mercury of the maximum. From the last, the registered minimum will, in general, be higher than the true minimum, and so much the more when the change of temperature is most rapid, or when the diurnal range is greatest, namely, near the Equinoxes. See Table III.

If we apply a correction to the monthly means, Table I., for the Sunday means wanting, which may be derived with sufficient accuracy from a comparison of the monthly means from the self-registering thermometers, when the Sundays are included and omitted, we obtain the true means for 1843 as follow:—

Jan.	Feb.	March.	April.	May.	June.	July.	August.	Sept.	Oct.	Nov.	Dec.
38°·4	33°·0	39°·3	44°·9	46°·7	51°·8	56°·8	57°·2	55°·7	42°·8	39°·4	45°·4

Winter, 39°·0; Spring, 43°·6; Summer, 55°·3; Autumn, 46°·0.

Mean Temperature for the year 1843 = 46°·05.

It is evident that, for the year 1843, the months of January, February, and March constitute the meteorological season, Winter; and July, August, and September constitute Summer. The means for this mode of grouping are—

Jan., Feb., March, 36°·9; April, May, June, 47°·8; July, August, Sept., 56°·6; Oct., Nov., Dec., 42°·5.

TABLE III.—Mean Temperature of the Air at the Observation Hours for each Month and Quarter of 1843.

Period.	18 ^h .	20 ^h .	22 ^h .	0 ^h .	2 ^h .	4 ^h .	6 ^h .	8 ^h .	10 ^h .	Mean.	Range.
January	38·10	37·81	38·07	39·80	40·60	40·05	39·30	38·54	38·07	38·72	2·79
February	31·85	31·99	32·66	34·94	35·74	35·20	33·35	32·18	32·05	32·98	3·89
March	34·84	35·85	39·22	43·07	44·76	44·64	42·08	38·84	37·91	39·07	9·92
April	39·26	42·70	47·32	49·47	50·76	50·17	47·44	44·15	42·40	44·55	11·50
May	42·10	45·18	48·45	50·62	51·47	50·98	49·80	47·13	44·47	46·57	9·37
June	48·35	51·00	53·41	55·05	55·92	56·25	55·47	52·99	49·24	51·97	7·90
July	52·13	56·33	59·73	61·28	62·41	61·30	59·66	56·67	54·10	56·83	10·28
August	50·10	54·26	59·46	63·13	64·91	64·76	62·25	57·92	55·25	57·29	14·81
September	47·80	50·96	56·56	61·77	64·24	64·10	60·80	55·50	52·63	55·22	16·44
October	39·12	39·88	43·60	47·01	47·77	47·07	43·32	40·95	40·17	42·27	8·65
November	38·22	38·68	39·93	42·30	43·33	42·03	39·15	38·49	38·24	39·59	5·11
December	44·40	44·44	45·98	46·85	47·35	46·28	45·07	44·77	44·59	45·26	2·95
Spring	38·73	41·24	45·00	47·72	49·00	48·60	46·44	43·37	41·59	43·40	10·27
Summer	50·19	53·86	57·53	59·82	61·08	60·77	59·13	55·86	52·86	55·36	10·89
Autumn	41·71	43·17	46·70	50·36	51·78	51·07	47·76	44·98	43·68	45·69	10·07
Winter	38·12	38·08	38·90	40·53	41·23	40·51	39·24	38·50	38·24	38·99	3·15
The Year	42·19	44·09	47·03	49·61	50·77	50·24	48·14	45·68	44·09	45·86	8·58

In obtaining the means for the month of January, the observations in the first week were rejected; no observation having been made at 18^h in the second week, a correction was applied to the mean for that hour of $-3^{\circ}\cdot29$, obtained from Table I. as follows:—

$$\{\text{Mean temp., Jan. 9—31} = 40^{\circ}\cdot32 \text{ minus, mean temp., Jan. 16—31} = 43^{\circ}\cdot81\} = -3^{\circ}\cdot29.$$

The means were afterwards corrected by $-0^{\circ}\cdot9$, in order to render the mean for the month similar to that obtained, Table I., from the whole month.

Diurnal Variation of Temperature.—The period of minimum temperature is not indicated by the above observations. The maximum temperature occurs nearly at the following periods in the means for the four meteorological seasons:—

Spring,	maximum temperature, occurs at 1 ^h 30 ^m P.M. Makerstoun mean time.
Summer, 1 ^h 45 ^m
Autumn, 1 ^h 35 ^m
Winter, 1 ^h 10 ^m
The Year, 1 ^h 30 ^m

If we examine the monthly means separately, it will be found that the maximum occurs about the same time, namely, 1^h 10^m in the months of January, February, May, July, October, November, and December,

and considerably later in the other months, being about 2^h 40^m in June. If we group the months into the astronomical quarters, we arrive at the following result :—

Spring, maximum temperature, occurs at 1^h 40^m P.M. Makerstoun mean time.
 Summer, 1^h 30^m
 Autumn, 1^h 50^m
 Winter, 1^h 0^m

Or, that the maximum temperature occurs later in the day at the equinoxes than at the solstices. It will require other years observations to prove the generality of this fact; but it seems to bear some relation, and that apparently not of difficult explanation, to the amount of the diurnal range of temperature.

The mean temperature for the year occurs at 8^h 22^m A.M.
 6^h 59^m P.M.

The interval between these periods is 10^h 37^m

The critical interval varies with each month, and is greatest in June, being 11^h 46^m, and least in February, being 8^h 11^m.

TABLE IV.—Errors of the Approximate Mean Temperatures for each Month and Quarter in 1843, deduced from one or two Daily Observations.

Periods.	True Mean.	Approximate Means (+) greater, or (-) less than true Means.											
		Max. and Min.	18 ^h and 5 ^h .	18 ^h and 6 ^h .	19 ^h and 6 ^h .	20 ^h and 7 ^h .	20 ^h and 8 ^h .	21 ^h and 8 ^h .	22 ^h and 9 ^h .	22 ^h and 10 ^h .	23 ^h and 10 ^h .	18 ^h and 0 ^h .	8 ^h .
January	38.72	+0.3	+0.15	-0.02	-0.10	-0.36	-0.55	-0.48	-0.54	-0.65	-0.22	+0.23	-0.18
February	32.98	+0.4	+0.08	-0.38	-0.34	-0.65	-0.90	-0.73	-0.59	-0.63	-0.06	+0.41	-0.80
March	39.07	+1.2	+0.03	-0.61	-0.36	-0.92	-1.73	-0.88	-0.28	-0.51	+0.45	-0.12	-0.23
April	44.55	+0.7	-0.52	-1.20	-0.34	-0.31	-1.13	+0.03	+0.74	+0.33	+0.84	-0.17	-0.40
May	46.57	+0.4	-0.33	-0.62	+0.15	+0.25	-0.42	+0.40	+0.55	-0.11	+0.43	-0.21	+0.56
June	51.97	+0.1	+0.13	-0.06	+0.60	+0.64	+0.02	+0.62	+0.61	-0.65	-0.24	-0.27	+1.02
July	56.83	+0.3	-0.53	-0.94	+0.11	+0.42	-0.33	+0.52	+0.72	+0.08	+0.47	-0.13	-0.16
August	57.29	+0.6	-0.49	-1.12	-0.08	-0.12	-1.21	+0.10	+0.73	+0.06	+0.98	-0.68	+0.63
September	55.22	+0.5	-0.10	-0.92	-0.13	-0.67	-1.99	-0.59	+0.09	-0.63	+0.67	-0.44	+0.28
October	42.27	+1.1	-0.12	-1.05	+0.86	-1.27	-1.86	+0.93	-0.19	-0.39	-0.46	+0.79	-1.32
November	39.59	+0.2	-0.19	-0.91	-0.79	-0.84	-1.01	-0.70	-0.45	-0.51	+0.08	+0.67	-1.10
December	45.26	-0.3	-0.23	-0.53	-0.52	-0.58	-0.66	-0.27	+0.07	+0.02	+0.24	+0.36	-0.49
Spring	43.40	+0.8	-0.28	-0.82	-0.19	-0.33	-1.10	-0.16	-0.34	-0.11	+0.57	-0.18	-0.03
Summer	55.36	+0.3	-0.29	-0.70	+0.21	+0.31	-0.50	+0.41	+0.58	-0.17	+0.40	-0.36	+0.50
Autumn	45.69	+0.6	-0.13	-0.96	-0.59	-0.92	-1.66	-0.74	-0.18	-0.50	+0.41	+0.34	-0.71
Winter	38.99	+0.1	0.00	-0.31	-0.32	-0.52	-0.70	-0.50	-0.36	-0.42	-0.02	+0.33	-0.49
The Year	45.86	+0.5	-0.17	-0.70	-0.25	-0.36	-0.98	-0.24	+0.09	-0.30	+0.34	+0.04	-0.18
The 12 months.													
Mean of Errors		0.5	0.24	0.70	0.36	0.59	0.98	0.52	0.46	0.38	0.43	0.37	0.60
Range of Errors		1.5	0.68	1.18	1.65	1.91	2.01	1.81	1.33	0.98	1.44	1.47	2.34

The quantities given as the true means are from Table III.; they are, therefore, only approximate, but they must be very near the truth. The errors of the mean from the maximum and minimum thermometer are obtained from Table II., after deleting the means for Sundays. The means for the odd hours were obtained by taking the mean of the even hours between which the odd hours lie.

The couple of hours best fitted for observations, in order to obtain the best approximation to the monthly means, must evidently be determined by

- 1st, The smallness of the mean of the monthly errors,
- 2d, The smallness of the range of the monthly errors.

The smaller the second is the more nearly will the approximate curve resemble the true curve in *form*, and the smaller the first the more nearly will the approximate curve approach the true curve in position.

In the foregoing Table, the range of the errors, and their mean for the 12 months (independent of sign), are given for each couple of hours. The hours which seem best to satisfy the two conditions are—

1st, 18 ^h and 5 ^h	Göttingen, or 5 ^h 10 ^m A.M. and 4 ^h 10 ^m P.M.	Makerstoun mean time.
2d, 22 ^h and 10 ^h or 9 ^h 10 ^m A.M. and 9 ^h 10 ^m P.M.
3d, 18 ^h and 0 ^h or 5 ^h 10 ^m A.M. and 11 ^h 10 ^m A.M.
4th, 19 ^h and 6 ^h or 6 ^h 10 ^m A.M. and 5 ^h 10 ^m P.M.
5th, 23 ^h and 10 ^h or 10 ^h 10 ^m A.M. and 9 ^h 10 ^m P.M.
6th, 22 ^h and 9 ^h or 9 ^h 10 ^m A.M. and 8 ^h 10 ^m P.M.

The first couple of hours is considerably superior to any of the others, the mean of the errors being only 0°.24, and their range only 0°.68, while the error for the year is only -0°.17. The second couple of hours is more convenient. For ordinary purposes, the maximum and minimum register thermometers seem sufficiently accurate.*

TABLE V.—Diurnal Ranges of Temperature for each Civil Day in 1843, as deduced from the Observations of the Maximum and Minimum Register Thermometers.

Civil Day.	January.	February.	March.	April.	May.	June.	July.	August.	September.	October.	November.	December.
1	9.2	7.3	10.9	13.7	28.5	5.7	16.9	12.0	17.6	11.4	17.7	8.4
2	4.4	1.1	8.2	13.6	19.0	19.5	17.0	13.9	16.8	11.0	15.9	22.8
3	24.1	4.3	8.4	11.9	20.0	3.5	9.6	17.0	12.4	19.8	18.0	12.0
4	4.9	17.3	21.0	13.1	23.2	6.9	20.9	20.0	13.9	16.0	20.4	5.9
5	3.0	3.2	15.4	9.1	14.4	1.2	15.0	19.9	31.8	12.7	16.2	2.0
6	17.5	7.9	15.6	20.8	16.6	11.0	13.3	18.7	23.9	8.5	16.6	7.9
7	7.3	6.8	12.5	13.0	17.4	13.5	22.4	21.0	29.5	13.0	7.8	11.3
8	3.9	2.9	22.9	12.8	9.6	9.9	18.5	13.9	36.5	5.8	7.2	4.9
9	18.6	19.3	9.6	9.5	7.9	12.1	17.4	29.3	18.0	11.2	8.0
10	5.3	6.5	12.1	13.7	9.5	12.5	15.3	21.3	24.6	8.6	8.9	11.5
11	5.0	6.2	22.5	17.1	24.9	12.9	12.7	23.7	15.6	8.0	11.1	7.8
12	11.0	4.7	9.9	22.5	22.6	4.0	21.7	23.8	15.7	6.5	10.1	8.8
13	17.4	8.0	8.7	10.8	9.0	8.6	13.7	27.9	21.0	17.0	8.7	2.7
14	2.0	2.6	18.6	24.0	16.4	17.1	23.3	27.5	28.3	13.8	14.6	3.8
15	9.7	23.1	9.8	6.5	18.3	17.1	14.2	15.3	18.6	13.9	5.0
16	14.2	11.2	13.6	1.8	25.0	16.3	15.5	28.9	24.9	11.4	10.0
17	15.9	13.9	6.9	21.0	6.8	19.9	19.9	22.2	20.5	8.5	14.5	14.5
18	6.9	29.5	19.9	18.8	11.2	13.1	11.6	27.2	20.5	16.1	9.5	10.0
19	5.9	19.6	12.8	17.7	21.0	7.1	13.5	26.6	30.9	23.5	15.5	4.8
20	2.4	6.3	10.9	21.7	15.8	24.8	11.0	12.9	21.3	15.6	9.2	7.6
21	16.7	5.9	18.4	15.6	4.5	16.8	13.1	22.4	9.2	9.0	16.0	7.7
22	20.7	4.1	16.2	6.5	3.6	20.4	24.1	9.9	30.8	19.1	6.9	17.7
23	8.0	2.7	10.0	8.5	4.2	27.4	11.0	22.1	33.0	9.6	10.3	5.7
24	4.3	4.1	8.9	25.9	5.0	21.6	20.6	33.4	11.2	5.6	10.3	4.8
25	4.1	3.0	4.9	11.9	8.1	8.9	31.2	19.7	6.0	16.9	9.1	6.5
26	4.2	6.6	11.0	14.4	19.2	11.9	14.3	21.1	11.5	18.0	26.1	5.3
27	12.2	6.7	3.7	24.7	10.3	14.4	15.8	21.3	11.8	22.1	3.8	9.6
28	1.5	6.6	9.3	6.5	6.3	11.3	17.5	20.7	14.1	12.5	6.1	10.5
29	12.2	26.0	20.6	18.3	17.5	15.0	14.6	23.6	4.5	3.4	3.0
30	1.2	27.6	13.8	22.4	16.8	16.8	30.7	18.0	11.4	21.4	3.1
31	10.5	11.5	6.1	17.5	23.3	15.9	6.1
Mean	9.0	7.8	14.1	15.2	13.3	13.6	16.7	20.2	20.8	13.6	12.4	8.1

* There are three couples of homonymous hours given in the Table, but only one couple gives satisfactory results. It will be found that twelve or thirteen combinations of hours, having the common interval of eleven hours (nearly the critical interval), will give a mean error for the year from a third to a half less than that from the twelve combinations of homonymous hours, the combinations commencing with 10^h P.M. and 9^h A.M., 11^h P.M. and 10^h A.M., and so on to the twelfth or thirteenth couple.

Diurnal Range of Temperature.—The diurnal ranges deduced from the means, Table III., are imperfect, as the hours of the minima are not included in the Summer months. Making every allowance for this deficiency, there is little difficulty in perceiving that the ranges are greater, on the whole, for the months near the Equinoxes than for the Summer months. This fact will be seen more distinctly in the means at the foot of Table V. From this Table, we find that the smallest mean of the diurnal ranges occurs in February and December, the mean of the ranges increases till April, diminishes in May and June, and again increases till August and September, when it is a maximum.*

From Table III., the range of the mean diurnal curve for the year must be about 9°.

From Table V., the mean of all the diurnal ranges for the year = 13°·7.

TABLE VI.—Extremes of Temperature for each Month from the Register Thermometers ; Extremes of Daily Mean Temperature for each Month, deduced from the Daily Observations ; and Extreme Diurnal Ranges for each Month from the Register Thermometers.

Month.	Extreme Temperatures.				Extremes of Mean Daily Temperature.				Extreme Diurnal Ranges.											
	Highest.		Lowest.		Range.		Mean.		Highest.		Lowest.		Range.		Mean.		Greatest.		Least.	
	d.	°	d.	°	°	°	d.	°	d.	°	°	°	d.	°	d.	°	d.	°	d.	°
January	27	55·1	15	19·9	35·2	37·5	27	51·1	3	30·1	21·0	41·0	3	24·1	30	1·2				
February	1	44·8	18	6·9	37·9	25·8	1	40·6	18	18·6	22·0	29·6	18	29·5	2	1·1				
March	18	61·5	4	20·2	41·3	40·8	22	49·9	4	30·1	19·8	40·0	30	27·6	27	3·7				
April	19	64·4	12	23·8	40·6	44·1	19	53·3	11	33·6	19·7	43·4	24	25·9	22	6·5				
May	14	62·8	19	30·4	32·4	46·6	13	52·5	29	42·6	9·9	47·5	1	28·5	16	1·8				
June	23	72·7	6	41·3	31·4	57·0	21	57·7	5	42·7	15·0	50·2	23	27·4	5	1·2				
July	14	69·5	25	36·4	33·1	52·9	26	61·5	20	51·7	9·8	56·6	25	31·2	3	9·6				
August	18	78·7	24	36·5	42·2	57·6	19	65·2	30	51·8	13·4	58·5	24	33·4	22	9·9				
September	8	77·0	29	30·6	46·4	53·8	2	64·4	{27 28}	44·1	20·3	54·2	8	36·5	25	6·0				
October	1	65·4	19	21·6	43·8	43·5	6	57·2	16	32·7	24·5	44·9	16	24·9	29	4·5				
November	4	54·5	26	26·5	28·0	40·5	27	48·9	25	30·8	18·1	39·8	26	26·1	29	3·4				
December	24	54·6	2	25·3	29·3	39·9	23	49·8	1	31·8	18·0	40·8	2	22·8	5	2·0				

Extremes of Temperature, 1843.

Highest temperature occurred	August 18,	= 7°·7	} range = 71°·8, mean = 42°·8.
Lowest	February 18,	= 6°·9	
Highest daily mean temperature occurred	August 19,	= 65°·2	} range = 46°·6, mean = 41°·9.
Lowest	February 18,	= 18°·6	
Highest weekly mean temperature occurred	August 14—19,	= 61°·5	} range = 36°·6, mean = 43°·2.
Lowest	February 13—18,	= 24°·9	
Highest monthly mean temperature occurred	August,	= 57°·3	} range = 24°·3, mean = 45°·1.
Lowest	February,	= 33°·0	

In each case, the interval between the highest and lowest is exactly six months.

The greatest diurnal range of temperature occurred	September 8,	= 36°·5
The lowest	February 2,	= 1°·1
The greatest range of temperature for a month occurred	February 18—March 18,	= 54°·6
The greatest range of daily mean temperature for a month occurred	February 18—March 18,	= 28°·2

* In this volume, I have followed the practice of meteorologists, and have grouped the months into the *meteorological* seasons. As far as the results for the year 1843 go, the value of this mode of grouping seems very questionable. With the single exception of the mean temperature, the facts (diurnal range, critical intervals, and periods of maxima) are more directly related to the *astronomical* seasons. Even for the mean temperature each year would require a particular mode of grouping ; it is only on the average of a number of years that June, July, and August are entitled to be called Summer. In 1843, it will be seen that July, August, and September are the three months with the highest mean temperature.

The cause of the diminished diurnal range in the midsummer months is obviously due to the sun's approach to perpetual apparition, as has been pointed out elsewhere.—See Professor FORBES'S Supplementary Report on Meteorology, Report Brit. Assoc. 1840. page 52.

TABLE VII.—Daily, Weekly, and Monthly Means of the Temperature of Evaporation, as deduced from the Nine Daily Readings of the Wet Bulb Thermometer in 1843.

Civil Day.	Jan.	Feb.	March.	April.	May.	June.	July.	Aug.	Sept.	Oct.	Nov.	Dec.
1	[.....]	38.2	29.3	47.5	43.9	46.4	53.2	53.9	59.0	[48.1]	32.1	31.4
2	29.4	33.4	30.5	[43.4]	41.6	49.3	[53.0]	54.7	61.9	47.6	37.2	39.9
3	29.1	28.3	31.4	44.3	44.6	43.3	55.6	55.2	[55.8]	49.4	36.5	[40.7]
4	36.5	32.0	28.3	43.3	46.5	[45.7]	52.5	55.1	50.2	53.9	45.5	47.3
5	32.2	[33.8]	[32.6]	41.7	40.6	40.9	57.7	51.4	50.4	53.6	[39.6]	43.4
6	35.5	31.2	39.7	43.0	42.3	45.7	54.4	[55.0]	59.6	55.0	44.3	40.1
7	37.6	38.6	36.7	42.9	[43.0]	48.9	53.6	55.1	52.8	51.4	40.9	46.8
8	[33.6]	39.6	29.2	38.6	42.3	50.2	53.7	59.1	54.7	[47.5]	33.1	43.1
9	34.2	34.1	32.6	[36.0]	44.4	49.7	[53.8]	53.9	56.2	42.6	31.0	44.9
10	31.2	32.8	34.7	30.3	41.9	49.9	54.3	52.0	[55.5]	41.5	38.0	44.8
11	30.8	33.6	40.6	30.1	43.8	[48.8]	52.3	55.9	59.4	41.1	42.9	44.7
12	23.7	[29.5]	[35.8]	31.2	46.9	45.7	54.6	57.3	58.9	36.7	[36.7]	45.0
13	33.5	30.3	36.8	32.2	50.5	46.0	56.1	[56.0]	51.3	33.0	38.5	44.5
14	29.1	23.9	35.4	46.7	[45.3]	51.4	54.2	54.3	52.6	33.5	33.6	45.9
15	[33.7]	22.2	34.8	45.2	45.3	52.7	55.5	56.8	56.3	[33.3]	36.5	44.9
16	34.5	23.6	37.2	[44.2]	44.0	51.7	[54.0]	59.7	55.2	30.5	35.5	37.5
17	37.7	24.3	43.7	46.7	41.5	49.0	54.3	61.9	[54.2]	34.6	42.9	[43.0]
18	44.0	17.5	45.1	45.4	39.7	[50.5]	54.3	60.8	55.4	31.4	35.9	43.2
19	44.1	[28.1]	[43.0]	49.2	39.5	46.1	49.9	61.2	49.6	31.8	[39.2]	41.5
20	38.4	32.2	40.1	44.1	43.5	50.3	49.5	[55.9]	56.3	44.2	39.3	45.2
21	30.2	35.0	44.7	49.1	[43.0]	53.0	50.7	49.7	54.4	43.4	41.5	40.3
22	[39.8]	36.1	47.0	46.4	44.4	51.0	53.3	52.8	50.7	[40.1]	40.0	46.7
23	39.3	35.6	45.8	[43.2]	46.0	52.5	[52.5]	48.9	52.6	46.1	35.4	47.8
24	43.8	36.3	40.9	41.8	45.1	51.2	49.3	49.8	[47.6]	39.2	30.7	[45.0]
25	43.2	33.2	38.5	41.0	47.4	[49.1]	53.0	53.5	44.8	35.7	30.5	47.9
26	42.8	[33.2]	[37.0]	37.0	50.1	48.9	59.4	52.5	42.7	32.0	[38.1]	44.8
27	49.2	32.7	31.7	41.2	48.2	46.8	52.5	[51.6]	40.6	32.8	46.8	42.8
28	41.3	31.9	33.1	42.0	[45.8]	44.3	52.7	54.9	40.7	41.2	45.9	43.2
29	[42.7]		31.8	41.9	40.3	48.1	54.3	50.3	42.2	[34.0]	39.1	43.9
30	40.5		37.5	[42.5]	44.3	51.1	[53.5]	48.6	55.0	33.1	42.4	42.2
31	44.1		45.9		44.8		52.7	54.0		32.6		[36.0]
Mean	36.8	31.5	37.1	41.7	44.2	48.6	53.6	54.6	52.4	40.3	38.3	43.4

The daily means have been obtained from the daily observations by the formulæ already given, Table I., for the dry bulb thermometer.

Annual Variation of the Temperature of Evaporation.—This follows the same law as the temperature of the air, Table I. The greatest monthly mean is that for August, the least is that for February.

The means for the meteorological seasons are as follow :—

Winter,	Dec., Jan., Feb.,	37°·2	Jan., Feb., Mar.,	35°·1
Spring,	Mar., Apr., May,	41°·0	Apr., May, June,	44°·8
Summer,	June, July, Aug.,	52°·3	July, Aug., Sept.,	53°·5
Autumn,	Sept., Oct., Nov.,	43°·7	Oct., Nov., Dec.,	40°·7

The year 1843, 43°·54.

TABLE VIII.—Hourly Means of the Temperature of Evaporation, as deduced from the Readings of the Wet Bulb Thermometer, at the Observation Hours for each month in 1843.

Period.	18 ^h .	20 ^h .	22 ^h .	0 ^h .	2 ^h .	4 ^h .	6 ^h .	8 ^h .	10 ^h .	Range.
January	36.30	36.17	36.18	37.44	38.12	37.87	37.48	36.53	36.09	2.03
February	30.65	30.65	31.03	32.78	33.40	33.20	31.81	30.92	31.10	2.75
March	33.76	34.71	37.40	40.31	41.31	41.10	39.48	37.34	36.46	7.55
April	37.98	40.72	43.85	44.83	45.69	45.20	43.70	41.80	40.35	7.71
May	41.14	43.47	45.51	46.85	47.11	47.05	46.09	44.72	43.07	5.97
June	46.41	48.09	49.40	50.25	51.17	51.17	50.90	49.10	47.05	4.76
July	50.61	53.66	55.34	56.20	56.78	55.86	55.49	53.79	52.12	6.17
August	49.27	52.71	56.13	58.47	59.12	58.80	57.87	55.90	54.07	9.85
September	46.82	49.88	53.87	56.80	57.93	57.42	56.41	53.64	51.50	11.11
October	37.99	38.82	41.33	43.72	43.83	43.52	41.23	39.48	38.80	5.84
November	37.32	37.80	38.75	40.24	41.06	39.95	37.94	37.55	37.27	3.79
December	42.81	42.84	43.70	44.76	45.03	44.32	43.27	42.98	42.88	2.22
Spring	37.63	39.63	42.25	44.00	44.70	44.45	43.09	41.29	39.96	7.07
Summer	48.76	51.49	53.62	54.97	55.69	55.28	54.75	52.93	51.08	6.93
Autumn	40.71	42.17	44.65	46.92	47.61	46.96	45.19	43.56	42.52	6.90
Winter	36.59	36.55	36.97	38.33	38.85	38.46	37.52	36.81	36.69	2.30
The Year	40.92	42.46	44.37	46.05	46.71	46.29	45.14	43.64	42.56	5.79

The observations in the first week of January were not made use of in obtaining the hourly means for that month. No observation having been made at 18^h in the second week, a correction was applied to the mean for that hour of $-3^{\circ}11$, obtained from Table VII. as follows :—

$$\{\text{Mean temp. Jan. 9—31} = 37^{\circ}99 \text{ minus mean temp. Jan. 16—31} = 41^{\circ}10\} = -3^{\circ}11.$$

The means were afterward corrected by $-1^{\circ}00$, in order to render the mean for the month from these means equal to that obtained, Table VII., from all the daily observations.

Diurnal Variation of the Temperature of Evaporation.—The maximum temperature of evaporation occurs rather later in the day than the maximum temperature of the air in Spring, and rather earlier in the day in Summer and Autumn. The hours of the maximum, Makerstoun mean time, for the four meteorological seasons, with their differences from the hours of the maximum temperature of the air (Table III.), are as follow :—

Spring,	1 ^h 35 ^m ,	occurring later than max. temp. of air by	5 ^m .
Summer,	1 ^h 20 ^m , earlier	25 ^m .
Autumn,	1 ^h 10 ^m ,	25 ^m .
Winter,	1 ^h 10 ^m ,	0 ^m .
The Year,	1 ^h 15 ^m ,	15 ^m .

The period of the minimum is not to be obtained from the nine daily observations.

The mean temperature of evaporation for the year occurs at 8^h 18^m A.M.
 7^h 19^m P.M.

The interval between the two periods is 11^h 1^m.

Range of the Diurnal Variation of the Temperature of Evaporation.—The ranges in the previous Table are imperfect, on account of the minimum being wanting in the Summer months ; but it seems as evident here, as in the case of the temperature of the air, that the range is less in the Midsummer months than for the months immediately preceding and succeeding them.

TABLE IX.—Daily, Weekly, and Monthly Means of the Pressure of Aqueous Vapour in inches of Mercury, as deduced from Tables I. and VII.

Civil Day.	Jan.	Feb.	March.	April.	May.	June.	July.	Aug.	Sept.	Oct.	Nov.	Dec.
1	in. [.....]	in. 0.221	in. 0.162	in. 0.322	in. 0.264	in. 0.326	in. 0.374	in. 0.403	in. 0.483	in. [0.324]	in. 0.193	in. 0.191
2	0.154	.183	.167	[.275]	.256	.355	[.371]	.410	.529	.300	.236	.254
3	.170	.166	.166	.272	.281	.278	.404	.414	[.423]	.337	.232	[.257]
4	.197	.173	.157	.279	.286	[.306]	.346	.417	.319	.396	.296	.321
5	.163	[.200]	[.184]	.253	.225	.253	.471	.344	.338	.386	[.245]	.268
6	.211	.178	.244	.269	.247	.301	.396	[.413]	.481	.417	.280	.227
7	.220	.241	.210	.267	[.258]	.322	.384	.423	.366	.359	.250	.310
8	[.191]	.259	.163	.228	.257	.333	.395	.498	.394	[.331]	.177	.261
9	.204	.195	.184	[.205]	.278	.334	[.387]	.383	.419	.275	.174	.306
10	.177	.178	.210	.150	.255	.322	.384	.361	[.423]	.275	.245	[.293]
11	.174	.177	.258	.151	.265	[.327]	.351	.426	.504	.272	.281	.294
12	.141	[.164]	[.210]	.166	.301	.296	.414	.453	.493	.202	[.227]	.299
13	.202	.172	.206	.165	.357	.312	.431	[.432]	.365	.178	.241	.290
14	.156	.134	.201	.288	[.294]	.365	.393	.394	.385	.184	.197	.296
15	[.202]	.125	.199	.282	.300	.354	.398	.458	.437	[.186]	.224	.283
16	.192	.135	.225	[.270]	.294	.333	[.396]	.504	.418	.167	.212	.217
17	.229	.143	.284	.291	.249	.327	.408	.541	[.408]	.207	.273	[.273]
18	.293	.107	.297	.280	.228	[.333]	.401	.501	.428	.180	.215	.285
19	.294	[.166]	[.275]	.317	.217	.303	.345	.499	.342	.177	[.243]	.260
20	.238	.167	.249	.271	.260	.323	.342	[.431]	.438	.285	.246	.298
21	.174	.218	.294	.320	[.273]	.361	.337	.329	.392	.271	.271	.260
22	[.250]	.228	.304	.315	.304	.319	.397	.390	.356	[.245]	.239	.308
23	.243	.223	.303	[.265]	.324	.360	[.375]	.324	.380	.289	.222	.323
24	.281	.223	.261	.238	.306	.348	.308	.335	[.312]	.238	.186	[.299]
25	.273	.196	.223	.239	.331	[.317]	.379	.383	.282	.208	.186	.331
26	.263	[.194]	[.220]	.207	.359	.322	.489	.389	.229	.179	[.237]	.294
27	.342	.181	.182	.235	.328	.296	.357	[.363]	.231	.185	.311	.279
28	.224	.182	.174	.264	[.307]	.256	.385	.423	.233	.264	.295	.281
29	[.259]		.176	.261	.241	.298	.399	.331	.262	[.202]	.220	.277
30	.217		.224	[.260]	.277	.334	[.386]	.320	.418	.198	.283	.258
31	.286		.299		.308		.365	.390		.196		[.220]
Mean	0.220	0.184	0.223	0.253	0.281	0.320	0.387	0.409	0.382	0.245	0.238	0.280

The quantities in Table IX. have been deduced from Tables I. and VII. by means of Dr ARJOHN'S formula, taken approximately, namely (Proceedings of the Royal Irish Academy, 1840),

$$f'' = f' - \frac{d}{88} \times \frac{29.7}{30.0}, \text{ the temperature of evaporation being above } 32^\circ$$

$$f'' = f' - \frac{d}{96} \times \frac{29.7}{30.0}, \dots \dots \dots \text{ below } 32^\circ$$

Where f'' is the tension of aqueous vapour in the air, given in the previous Table; f' , the tension of aqueous vapour, the air being saturated at the temperature of evaporation; d , the difference between the temperatures of the air and of evaporation; 29.7, the mean barometric pressure. The values of f' were obtained from the Table, page xl., Introduction to the Greenwich Observations, 1842. The errors for the monthly or hourly means, from the use of the approximate formula, are small, the greatest error is probably under 0.003 in. The errors of the daily means will be due chiefly to the want of the three two-hourly observations.

The Annual Variation of the Pressure of Aqueous Vapour follows the same march as the temperature of the air. The greatest monthly mean is that for August, and the least that for February; the former being 0.409 in., the latter being 0.184 in., and the annual range of the monthly means 0.225 in. The means for the mean meteorological seasons, and the meteorological seasons for the year 1843, are—

Spring,	Mar.,	Apr.,	May,	in. 0.252	Apr.,	May,	June,	in. 0.285
Summer,	June,	July,	Aug.,	0.372	July,	Aug.,	Sept.,	0.393
Autumn,	Sept.,	Oct.,	Nov.,	0.288	Oct.,	Nov.,	Dec.,	0.254
Winter,	Dec.,	Jan.,	Feb.,	0.228	Jan.,	Feb.,	Mar.,	0.209

The year 1843, 0.283 inch.

TABLE X.—Pressure of Aqueous Vapour, considered in relation to the Moon's Age and Declination.

Moon's Age.	No. of Daily Means.	Mean Pressure.	Moon's Age.	No. of Daily Means.	Mean Pressure.	After Moon farthest North.	No. of Daily Means.	Mean Pressure.	After Moon farthest North.	No. of Daily Means.	Mean Pressure.
Day.		in.	Day.		in.	Day.		in.	Day.		in.
15	9	0.299	0	12	0.278	0	11	0.257	14	11	0.293
16	11	.290	1	10	.284	1	12	.255	15	12	.285
17	10	.292	2	11	.274	2	9	.322	16	9	.333
18	11	.311	3	9	.253	3	11	.276	17	11	.309
19	10	.279	4	11	.280	4	12	.271	18	12	.298
20	9	.315	5	10	.277	5	11	.273	19	11	.282
21	12	.298	6	9	.305	6	12	.259	20	12	.288
22	9	.324	7	12	.295	7	11	.272	21	11	.262
23	11	.295	8	10	.310	8	12	.267	22	12	.305
24	10	.284	9	11	.277	9	9	.321	23	9	.341
25	11	.285	10	9	.281	10	11	.292	24	11	.317
26	10	.278	11	11	.284	11	12	.303	25	12	.302
27	9	.297	12	10	.293	12	11	.302	26	11	.278
28	11	.301	13	9	.303	13	12	.292	27	11	.262
29	9	.303	14	12	.285						

This Table has been formed from Table IX. in the manner already indicated, Table II. of the Abstracts of the Magnetical Observations, excepting that no means for the Sundays were employed.

Pressure of Aqueous Vapour with reference to the Moon's Age.—From the above, and the following means of groups, there seems to be a maximum of pressure about three days after the time of full moon, and a minimum about three days after the time of new moon.

12 days till 18 days, Full Moon,	in. 0.296	27 days till 3 days, New Moon,	in. 0.284
15 22 ...	0.301	0 7 ...	0.281
19 26 ...	0.295	4 11 ...	0.289
23 29 ...	0.292	8 14 ...	0.290

Pressure of Aqueous Vapour with reference to the Moon's Declination.—The means in the above Table seem very irregular. The projected quantities shew four maximum peaks, which occur at intervals of seven days, namely, on the 2d, 9th, 16th, and 23d days after the Moon has its greatest north declination; but these may be at once traced to the less number of observations from which the means are deduced for these days, and this due to the want of means for the Sundays. The means of groups are as follow:—

25 days till 3 days, Moon farthest North,	in. 0.279	11 days till 17 days, Moon farthest South,	in. 0.302
0 6 ...	0.273	14 20 ...	0.298
4 10 ...	0.279	18 24 ...	0.299
7 13 ...	0.293	21 27 ...	0.295

These means shew the minimum about three days after the Moon has its greatest north declination, and the maximum about three days after it has its greatest south declination.

Extreme Daily Mean Pressures of Aqueous Vapour and the Ranges.

	Jan.	Feb.	March.	April.	May.	June.	July.	Aug.	Sept.	Oct.	Nov.	Dec.
	in.	in.	in.	in.	in.	in.	in.	in.	in.	in.	in.	in.
Greatest,	0.342	0.259	0.304	0.322	0.359	0.365	0.489	0.541	0.529	0.417	0.311	0.331
Least,	0.154	0.107	0.157	0.150	0.217	0.253	0.308	0.320	0.229	0.167	0.174	0.191
Range,	0.188	0.152	0.147	0.172	0.142	0.112	0.181	0.221	0.300	0.250	0.137	0.140

The greatest daily mean in the year is that for August 17, being 0.541 in.
 The least February 18, being 0.107 ...
 The greatest range of the daily means in any month is that for September, being 0.300 ...
 The least June, being 0.112 ...
 The range of the daily means for the whole year 1843, is 0.434 ...

TABLE XI.—Hourly Means of the Pressure of Aqueous Vapour for each Month, as deduced from Tables III. and VIII., with the Means for the Quarters and Year 1843.

Period.	18 ^h .	20 ^h .	22 ^h .	0 ^h .	2 ^h .	4 ^h .	6 ^h .	8 ^h .	10 ^h .	Mean.	Range.
January	0.212	0.213	0.210	0.214	0.219	0.221	0.222	0.211	0.208	0.213	0.014
February	.178	.177	.176	.180	.184	.185	.183	.179	.183	.180	.009
March	.201	.207	.221	.236	.239	.235	.231	.223	.218	.220	.038
April	.231	.248	.263	.260	.265	.261	.259	.256	.244	.250	.034
May	.264	.280	.287	.292	.289	.293	.285	.284	.279	.281	.029
June	.308	.317	.321	.322	.336	.332	.333	.318	.312	.319	.028
July	.364	.393	.398	.404	.407	.395	.403	.392	.378	.387	.043
August	.355	.392	.423	.444	.443	.435	.437	.433	.415	.411	.089
September	.324	.360	.396	.414	.417	.405	.414	.402	.380	.381	.093
October	.233	.241	.251	.264	.258	.259	.252	.243	.237	.245	.031
November	.230	.235	.239	.242	.249	.239	.232	.232	.229	.235	.020
December	.273	.273	.275	.288	.289	.285	.277	.273	.273	.277	.016
Spring	.232	.245	.257	.263	.264	.263	.258	.254	.247	.250	.032
Summer	.342	.367	.381	.390	.395	.387	.391	.381	.368	.372	.053
Autumn	.262	.279	.295	.307	.308	.301	.299	.292	.282	.287	.046
Winter	.221	.221	.221	.228	.231	.230	.228	.221	.222	.227	.010
The Year	.264	.278	.288	.296	.299	.295	.294	.287	.279	.283	.035

The previous Table has been formed from Tables III. and VIII. by means of the formula given after Table IX.

The Diurnal Variation of the Pressure of Aqueous Vapour also follows somewhat nearly the march of temperature of the air; there are, however, some apparent irregularities in the progression of the former that neither appear in the latter nor in that of the temperature of evaporation. In January, the maximum of pressure occurs about 4 P.M., in February, about 3 P.M., while, in the other months, it occurs nearer 1 P.M. than any other hour. In some of the months there are one or more secondary minima; some of these are so marked as to render it probable that they are not accidental. In the month of April, a secondary minimum occurs about 11 A.M.; in May and October, about 1 P.M.; and in June, July, August, and September, about 3 P.M.; the maxima occurring about two hours before and after the minima. The minima are most distinctly marked in July, August, and September. The occurrence of minima, as here indicated, is, perhaps, what might have been expected from the non-coincidence of the periods of maxima for the temperature of the air and the temperature of evaporation. Thus, taking the most marked case, the month of August, the temperature of the air and the temperature of evaporation go on increasing together till a little after 1 P.M.; the temperature of evaporation then commences falling; the temperature of the air, however, increases for nearly three-quarters of an hour after this. The increasing pressure of aqueous vapour will, therefore, evidently receive a sudden check at the time of the maximum temperature of evaporation, and it will diminish rapidly while the temperature of the air and of evaporation are moving in opposite directions. When, however, the temperature of the air commences falling also, the pressure of vapour will diminish less rapidly, until the falling temperature of the air makes up for its lost time and gains ground on the falling temperature of evaporation, thus producing a second maximum of pressure; after this they diminish together, according to nearly the same law as they increased in the morning. The occurrence of the maximum temperature of evaporation later than that of the air will evidently produce a minimum before the temperature of evaporation attains its maximum.*

* The afternoon secondary maximum and minimum seemed to me, at first, due to a local cause, namely, the action of the sun on the soil near the thermometers when it approaches the prime vertical, producing in this way an abnormal state of the atmosphere near the thermometers. I have, however, been induced to reject this hypothesis for the following reasons:—With a similar amount of sunshine, a similar action should be visible in the morning, but there is none visible; the effect should be most distinct near mid-summer, whereas it is most evident in August and September; it should be as well marked in March, April, and May, but it is not evident at all in these months. The comparative amounts of sunshine for the year 1843 can only be estimated from the observed surface of cloud, and this differs little before 7 A.M. and after 5 P.M., but it is evident that the quantity of vapour may be connected with the surface of cloud by other than local considerations, as will be seen on examination of the tables for the surface of cloud. Finally, the minimum occurs at 1^h P.M. in May and October, and at 11^h A.M. in April, when the cause supposed could not operate.

The periods of maxima for the four meteorological seasons are as follow :—

- Spring, 1^h 10^m P.M. Makerstoun mean time.
- Summer, 1^h 0^m P.M.
- Autumn, 0^h 45^m P.M.
- Winter, 1^h 30^m P.M.
- The Year, 1^h 0^m P.M.

A secondary minimum occurs in Summer at 3^h 40^m P.M., and a secondary maximum about 5^h P.M. There is a marked inflection in the curve for Autumn at 3^h 10^m P.M. In the mean for the whole year, the secondary minimum probably occurs about 4^h P.M., the secondary maximum about 5^h P.M.

The periods of maxima and minima for the four astronomical seasons are—

- Spring, principal max., 1^h 40^m P.M.
- Summer, 1^h 20^m P.M. Secondary min., 4^h 10^m P.M. Secondary max., 5^h 0^m P.M.
- Autumn, 0^h 0^m Noon. 3^h 40^m P.M. 5^h 10^m P.M.
- Winter, 1^h 10^m P.M.

The mean pressure of aqueous vapour for the year occurs at 8^h 10^m A.M.
 8^h 10^m P.M.

The interval between the periods is, 12^h 0^m.

Range of the Diurnal Variation of the Pressure of Aqueous Vapour.—The range is inexact for the summer months; it is here, however, as evident, as in the previous cases of temperature, that the range is less in the summer months than in the months immediately preceding and succeeding. The greatest range is that for September, being about 0.100 inch.

TABLE XII.—Mean Relative Humidity for each Civil Day, Week, and Month of 1843, Saturation being = 1.

Civil Day.	Jan.	Feb.	March.	April.	May.	June.	July.	Aug.	Sept.	Oct.	Nov.	Dec.
1	[.....]	0.819	0.835	0.880	0.772	0.973	0.792	0.884	0.893	[0.825]	0.946	0.965
2	0.766	.803	.819	[.854]	.850	.944	[.779]	.861	.874	.763	.971	.937
3	.914	.922	.769	.795	.829	.883	.775	.847	[.821]	.842	.987	[.890]
4	.749	.801	.844	.891	.753	[.891]	.709	.867	.714	.848	.860	.889
5	.718	[.884]	[.831]	.827	.726	.872	.935	.759	.790	.821	[.882]	.820
6	.894	.868	.881	.851	.765	.875	.815	[.851]	.841	.876	.841	.759
7	.843	.923	.827	.845	[.786]	.797	.812	.894	.779	.831	.856	.859
8	[.847]	.985	.849	.841	.821	.778	.857	.952	.790	[.899]	.776	.798
9	.911	.852	.848	[.788]	.822	.811	[.814]	.790	.804	.911	.849	.956
10	.859	.798	.929	.698	.831	.745	.770	.802	[.857]	.975	.992	[.883]
11	.857	.753	.918	.716	.784	[.827]	.742	.854	.956	.978	.927	.896
12	.928	[.828]	[.861]	.776	.807	.848	.887	.880	.946	.774	[.920]	.906
13	.935	.869	.792	.733	.877	.920	.864	[.870]	.867	.784	.931	.884
14	.796	.854	.831	.754	[.852]	.859	.814	.812	.881	.807	.895	.836
15	[.883]	.845	.847	.801	.893	.733	.758	.939	.878	[.828]	.929	.823
16	.814	.877	.896	[.765]	.939	.697	[.835]	.935	.865	.819	.902	.828
17	.898	.917	.896	.768	.814	.818	.879	.926	[.877]	.912	.881	[.864]
18	.930	.870	.887	.778	.786	[.764]	.844	.839	.895	.874	.900	.931
19	.930	[.893]	[.881]	.758	.731	.863	.854	.804	.859	.831	[.898]	.878
20	.915	.749	.892	.802	.772	.731	.864	[.842]	.883	.872	.918	.887
21	.888	.969	.896	.779	[.865]	.744	.769	.787	.798	.839	.951	.952
22	[.894]	.979	.817	.913	.974	.676	.892	.890	.860	[.844]	.839	.856
23	.900	.970	.881	[.801]	.991	.768	[.825]	.808	.856	.787	.978	.871
24	.873	.933	.922	.739	.939	.791	.710	.809	[.791]	.872	.964	[.899]
25	.861	.907	.814	.784	.935	[.755]	.826	.811	.822	.863	.974	.904
26	.827	[.890]	[.845]	.787	.913	.797	.889	.907	.654	.840	[.897]	.891
27	.881	.826	.875	.753	.872	.785	.756	[.834]	.757	.845	.864	.921
28	.687	.867	.757	.877	[.891]	.715	.875	.910	.764	.923	.831	.909
29	[.798]	.822	.864	.834	.729	.838	.838	.763	.856	[.904]	.769	.845
30	.687	.875	[.824]	.822	.732	[.833]	.806	.880	.930	.973	.832	[.886]
31	.885	.854		.972		.782	.812		.938			
Mean	0.852	0.873	0.855	0.800	0.845	0.803	0.820	0.850	0.837	0.860	0.904	0.878

Table XII. has been formed in the following manner:— f being the elastic force of vapour, the air being saturated at the mean temperature t (Table I.), and f'' the elastic force of the vapour actually in the air (Table IX.), then h , the relative humidity in the previous table, is obtained from the formula,

$$h = \frac{f''}{f}$$

The values of f were obtained from the tables in the Introduction to the Greenwich Observations, 1842.

Annual Variation of Humidity.—This has not the same period as the temperature of the air or the pressure of aqueous vapour; the minimum occurs in June, and the maximum in Winter; in the beginning of the year February is a maximum, and in the end of the year November is *the* maximum. The following are the means for three different classes of seasons, viz. :—

The mean meteorological seasons, for which June, July, and August, constitute summer.

The meteorological seasons for the year 1843, for which July, August, September, constitute summer.

The astronomical seasons, for which May, June, July, constitute summer.

Seasons.	Mean Meteorological.	Meteorological for 1843.	Astronomical.
Spring, . . .	0·833	0·816	0·843
Summer, . . .	0·824	0·836	0·823
Autumn, . . .	0·867	0·881	0·849
Winter, . . .	0·868	0·860	0·878

The year 1843, 0·848.

For the year 1843, the most regular group is that of the astronomical seasons. The greatest range of the means is that for the meteorological seasons of 1843, being 0·065; that for the astronomical group being 0·055, and that for the *mean* meteorological seasons being 0·044. The range of the monthly means is 0·104.

Extremes of the Daily Means, and the Ranges for each Month.

	Jan.	Feb.	March.	April.	May.	June.	July.	Aug.	Sept.	Oct.	Nov.	Dec.
Greatest,	0·935	0·985	0·929	0·913	0·991	0·973	0·935	0·952	0·956	0·978	0·992	0·965
Least,	0·687	0·749	0·757	0·698	0·726	0·676	0·709	0·759	0·654	0·763	0·769	0·759
Range,	0·248	0·236	0·172	0·215	0·265	0·297	0·226	0·193	0·302	0·215	0·223	0·206

November 10th was the most humid day, and September 26th the least humid day in the year, the ratio to saturation for the former being 0·992, and for the latter 0·654. The total range of the daily means for the year 1843 is therefore 0·338. The greatest monthly range of the daily means is that for September, being 0·302, and least monthly range is that for March, being 0·172.

TABLE XIII.—Relative Humidity, Saturation being = 1, with reference to the Moon's Age and Declination.

Moon's Age.	No. of daily Means.	Humidity.	Moon's Age.	No. of daily Means.	Humidity.	After Moon farthest North.	No. of daily Means.	Humidity.	After Moon farthest North.	No. of daily Means.	Humidity.
15	9	0·843	0	12	0·833	0	11	0·852	14	11	0·884
16	11	·854	1	10	·844	1	12	·829	15	12	·842
17	10	·873	2	11	·847	2	9	·863	16	9	·819
18	11	·870	3	9	·841	3	11	·839	17	11	·817
19	10	·858	4	11	·846	4	12	·848	18	12	·844
20	9	·853	5	10	·848	5	11	·835	19	11	·816
21	12	·849	6	9	·830	6	12	·857	20	12	·874
22	9	·855	7	12	·850	7	11	·856	21	11	·877
23	11	·880	8	10	·872	8	12	·831	22	12	·849
24	10	·862	9	11	·860	9	9	·826	23	9	·872
25	11	·851	10	9	·853	10	11	·810	24	11	·879
26	10	·862	11	11	·852	11	12	·861	25	12	·863
27	9	·829	12	10	·819	12	11	·860	26	11	·849
28	11	·899	13	9	·823	13	12	·861	27	11	·837
29	9	·862	14	12	·831						

This Table has been formed from Table XII. in the manner already referred to, Table X.

Humidity with reference to the Moon's Age.—The following means of groups indicate a minimum of humidity about four days before full Moon, and a maximum about four days before new Moon.

12 days till 18 days, Full Moon, 0.845	27 days till 3 days, New Moon, 0.851
15 22 ... 0.857	0 7 ... 0.842
19 26 ... 0.859	4 11 ... 0.851
23 29 ... 0.864	8 14 ... 0.844

Humidity with reference to the Moon's Declination.—The following means of groups indicate a maximum of humidity about four days before the Moon attains its greatest north declination, and a minimum about four days before it attains its greatest south declination.

25 days till 3 days, Moon farthest North, 0.847	11 days till 17 days, Moon farthest South, 0.849
0 6 ... 0.846	14 20 ... 0.842
4 10 ... 0.838	18 24 ... 0.857
7 13 ... 0.844	21 27 ... 0.861

TABLE XIV.—Hourly Means of the Relative Humidity for each Month and Quarter in 1843, Saturation being = 1.

Period.	18 ^h .	20 ^h .	22 ^h .	0 ^h .	2 ^h .	4 ^h .	6 ^h .	8 ^h .	10 ^h .	Mean.	Range.
January	0.858	0.869	0.850	0.814	0.811	0.837	0.860	0.841	0.842	0.844	0.058
February	.899	.889	.863	.815	.811	.830	.876	.891	.920	.877	.109
March	.914	.908	.860	.803	.766	.758	.813	.881	.886	.857	.156
April	.895	.855	.774	.708	.692	.694	.757	.839	.850	.807	.203
May	.930	.883	.811	.766	.735	.759	.768	.840	.903	.845	.195
June	.873	.821	.766	.727	.737	.720	.740	.768	.857	.800	.153
July	.908	.849	.768	.740	.718	.723	.779	.838	.881	.824	.190
August	.947	.907	.823	.764	.720	.711	.775	.887	.930	.857	.236
September	.936	.933	.850	.746	.693	.676	.771	.893	.931	.852	.260
October	.910	.916	.837	.783	.746	.766	.848	.890	.891	.857	.170
November	.927	.929	.909	.846	.838	.845	.906	.924	.923	.902	.091
December	.886	.886	.844	.860	.848	.866	.877	.875	.881	.873	.042
Spring	.913	.882	.815	.759	.731	.737	.779	.853	.880	.836	.182
Summer	.909	.859	.786	.744	.725	.718	.765	.831	.889	.827	.191
Autumn	.924	.926	.865	.792	.759	.762	.842	.902	.915	.870	.167
Winter	.881	.881	.852	.830	.823	.844	.871	.869	.881	.865	.058
The Year	.907	.887	.830	.781	.760	.765	.814	.864	.891	.850	.147

Table XIV. has been formed from Tables III. and VIII. by means of the formula given after Table XII.

Diurnal Variation of the Relative Humidity.—The maximum humidity occurs between 9 P.M. and 5 A.M. The minimum occurs as early as 10^h 30^m A.M. in December, and as late as 2^h 30^m in March and September. The progression is regular in each month, with the exceptions of June and December; a secondary maximum occurs in the former at 1^h 10^m P.M., and in the latter at 11^h 10^m A.M., the minima occurring two hours before and after. The following are the periods of minima for the four meteorological seasons, and also for the four astronomical seasons :—

Meteorological Seasons.	Astronomical Seasons.
Spring, 1 ^h 40 ^m P.M.	Spring, 2 ^h 0 ^m P.M. Makerstoun mean time.
Summer, 2 ^h 30 ^m P.M.	Summer, 1 ^h 25 ^m P.M.
Autumn, 2 ^h 10 ^m P.M.	Autumn, 2 ^h 20 ^m P.M.
Winter, 0 ^h 30 ^m P.M.	Winter, 0 ^h 50 ^m P.M.
	The year, 1 ^h 50 ^m .

From the periods for the four astronomical seasons, it is evident that the minimum humidity occurs earlier in Summer than in the preceding and succeeding quarters. For the astronomical seasons, the minimum humidity occurs after the maximum temperature of the air in Spring and Autumn, while it occurs before the maximum temperature in Summer and Winter. In the mean for the year, the minimum humidity occurs about 20^m after the maximum temperature, and about 50^m after the maximum pressure of aqueous vapour. The secondary maxima and minima, shewn in some of the monthly means for the pressure of aqueous vapour, have no counterparts in the means for the humidity.

The ascending or forenoon branches of the diurnal curves of temperature and pressure of aqueous vapour exhibit more rapid changes than the afternoon or descending branch; while, for the humidity, the afternoon or ascending branch has the most rapid variations. In the mean for the year, however, the variation is but slightly more rapid in the afternoon than in the forenoon branch. These remarks have reference to the portion of the diurnal curve included in the limits of the observations for 1843, viz., 5 A.M. till 9 P.M.

The mean humidity for the year occurs at 8^h 28^m A.M.
 6^h 40^m P.M.

The interval between these periods is, 10^h 12^m

Diurnal Range of Humidity.—The diurnal ranges, as far as can be judged from Table XIV., are somewhat less in the summer months than in the months immediately preceding or succeeding them.

TABLE XV.—Daily, Weekly, and Monthly Means of the Height of the Barometer in 1843.

Civil Day.	Jan.	Feb.	March.	April.	May.	June.	July.	Aug.	Sept.	Oct.	Nov.	Dec.
1	in. [.....]	29.256	29.630	29.026	30.184	29.335	29.558	29.505	30.059	[29.677]	29.515	29.903
2	29.901	29.093	29.881	[29.243]	30.070	29.055	[29.530]	29.264	30.078	29.700	29.645	29.894
3	29.880	28.914	30.015	29.369	29.717	26.189	29.471	29.130	[30.060]	29.780	29.358	[29.834]
4	29.460	29.469	30.108	29.185	29.399	[29.400]	29.661	29.190	30.075	29.767	29.328	29.945
5	29.603	[29.559]	[30.008]	29.382	29.270	29.682	29.458	29.424	30.146	29.684	[29.385]	29.545
6	29.713	29.856	29.929	29.318	29.272	29.693	29.379	[29.545]	30.046	29.204	29.424	29.810
7	29.292	30.026	29.991	29.050	[29.544]	29.449	29.579	29.826	30.042	29.056	29.232	29.678
8	[29.108]	29.997	30.125	29.132	29.585	28.848	29.695	29.838	30.032	[29.295]	29.325	29.868
9	28.967	29.987	30.098	[29.429]	29.756	28.838	[29.734]	29.865	29.962	29.337	29.585	29.995
10	28.443	29.978	29.806	29.678	29.982	29.429	29.864	29.926	[29.997]	29.537	29.323	[29.943]
11	28.632	30.007	29.847	29.763	29.976	[29.502]	29.999	29.993	29.823	28.952	29.838	29.950
12	28.669	[29.757]	[29.623]	29.631	29.796	29.983	29.891	30.022	30.111	29.060	[29.770]	30.119
13	28.022	29.777	29.218	29.693	29.498	29.956	29.841	[29.920]	30.011	29.290	29.957	30.047
14	28.389	29.550	29.196	29.473	[29.614]	29.961	29.805	29.886	29.788	29.544	30.080	29.953
15	[29.049]	29.242	29.572	28.745	29.401	29.975	29.739	29.830	29.746	[29.409]	29.836	29.845
16	29.453	29.107	29.722	[29.693]	29.397	29.916	[29.699]	29.861	29.781	29.368	29.800	30.054
17	29.777	29.420	29.520	29.778	29.618	29.884	29.848	29.890	[29.837]	29.371	29.384	[30.027]
18	29.985	29.550	29.665	29.791	29.830	[29.877]	29.506	29.875	29.818	29.824	29.073	30.187
19	30.169	[29.340]	[29.473]	29.679	29.856	29.839	29.454	29.649	30.044	30.105	[29.226]	30.134
20	30.014	29.327	29.550	29.519	29.749	29.911	29.317	[29.567]	29.844	29.803	29.094	29.992
21	29.730	29.325	29.219	29.561	[29.690]	29.738	29.360	29.597	29.924	29.602	29.042	30.036
22	[29.725]	29.310	29.163	29.548	29.555	29.809	29.362	29.137	30.238	[29.564]	28.963	29.784
23	29.535	29.390	29.250	[29.495]	29.601	29.852	[29.601]	29.255	30.323	29.503	29.192	29.934
24	29.365	29.551	29.594	29.775	29.549	29.862	29.793	29.502	[30.015]	29.240	29.343	[30.019]
25	29.538	29.570	29.860	29.270	29.320	[29.736]	29.938	29.520	30.100	29.129	29.395	30.136
26	29.616	[29.397]	[29.683]	29.298	29.243	29.742	29.839	29.625	29.900	29.257	[29.438]	30.102
27	29.372	29.027	29.800	29.580	29.141	29.627	29.725	[29.633]	29.603	29.280	29.087	30.121
28	29.260	29.216	29.774	29.390	[29.456]	29.525	29.678	29.530	29.638	28.586	29.643	30.180
29	[29.340]		29.822	29.565	29.710	29.525	29.237	29.688	29.679	[29.192]	29.967	30.064
30	29.218		29.436	[29.751]	29.776	29.506	[29.495]	29.931	29.500	29.256	29.909	29.769
31	28.316		29.063		29.546		29.564	29.956		29.259		[29.683]
Mean	29.358	29.498	29.661	29.488	29.622	29.620	29.637	29.656	29.935	29.404	29.475	29.963

The daily means in this Table have been obtained from the nine daily observations in the following manner :—If S be the sum of the nine observations from 18^h till 10^h, 18 be the height at 18^h, 10_p the height at 10^h preceding the 18^h, and 10_s the height at 10^h succeeding the 18^h, then the daily means for the Mondays were obtained from the formula,

$$\frac{2 \times 18 + S + 10_s}{12}$$

and for the other days of the week from the formula,

$$\frac{10_p + 18 + S + 10_s}{12}$$

It was found, from other observations, that means thus obtained differed very little from the truth.

Annual Variation of Atmospheric Pressure.—The lowest monthly mean pressure is that for January, being 29·358 in. ; the highest monthly mean pressure is that for December, being 29·963 in. ; the range of the monthly means is therefore 0·605 in. The following are the mean pressures for three different classes of seasons, viz. :—

The mean meteorological seasons, for which June, July, and August constitute summer.
 The meteorological seasons of 1843, for which July, August, and September constitute summer.
 The astronomical seasons, for which May, June, and July constitute summer.

Seasons.	Mean Meteorological.	Meteorological for 1843.	Astronomical.
	in.	in.	in.
Spring, . . .	29·590	29·577	29·549
Summer, . . .	·638	·743	·626
Autumn, . . .	·605	·614	·665
Winter, . . .	·606	·506	·599
Range of Means, .	0·048	0·237	0·116

The second group is the most marked ; it indicates the maximum pressure in the warmest quarter of 1843, and the minimum in the coldest quarter.

$$\text{The mean pressure for the year} = \frac{\text{in.}}{29\cdot610}.$$

TABLE XVI.—Height of the Barometer, with reference to the Moon's Age and Declination for 1843.

Moon's Age.	Number of Days.	Height of Barometer.	Moon's Age.	Number of Days.	Height of Barometer.	After Moon farthest North.	Number of Days.	Height of Barometer.	After Moon farthest North.	Number of Days.	Height of Barometer.
Days.		in.	Days.		in.	Days.		in.	Days.		in.
15	9	29·732	0	12	29·611	0	11	29·558	14	11	29·566
16	11	·593	1	10	·485	1	12	·587	15	12	·599
17	10	·653	2	11	·559	2	9	·561	16	9	·859
18	11	·702	3	9	·572	3	11	·516	17	11	·585
19	10	·751	4	11	·480	4	12	·582	18	12	·712
20	9	·723	5	10	·493	5	11	·687	19	11	·770
21	12	·674	6	9	·580	6	12	·744	20	12	·694
22	9	·698	7	12	·640	7	11	·743	21	11	·593
23	11	·582	8	10	·688	8	12	·600	22	12	·667
24	10	·622	9	11	·606	9	9	·641	23	9	·561
25	11	·685	10	9	·713	10	11	·483	24	11	·685
26	10	·560	11	11	·671	11	12	·492	25	12	·532
27	9	·628	12	10	·672	12	11	·514	26	11	·646
28	11	·553	13	9	·664	13	12	·580	27	11	·688
29	9	·623	14	12	·658						

This Table has been formed from Table XV. in the manner already referred to, Table X.

Atmospheric Pressure with reference to the Moon's Age.—From the means in the Table, and the following means of groups, it is distinctly evident that a maximum of pressure occurs about two days after full Moon, and a minimum of pressure about two days after new Moon; the same result has been obtained, Table X., for that portion of the atmospheric pressure due to the aqueous vapour.

12 days till 18 days, Full Moon, 29·668	27 days till 3 days, New Moon, 29·576
15 22 ... ·691	0 7 ... ·552
19 26 ... ·662	4 11 ... ·609
23 29 ... ·608	8 14 ... ·668

Atmospheric Pressure with reference to the Moon's Declination.—The means in the previous Table, and in the following means of groups, indicate two maxima and two minima. The principal maximum occurs about two days before the Moon is on the equator moving northwards; the two minima are nearly equal, the one occurring when the Moon is farthest north, the other about two days before it is farthest south; the secondary maximum occurs about one day before the Moon is on the equator moving southwards.

25 days till 3 days, Moon farthest North, 29·584	11 days till 17 days, Moon farthest South, 29·599
0 6 ... ·605	14 20 ... ·684
4 10 ... ·640	18 24 ... ·669
7 13 ... ·579	21 27 ... ·625

TABLE XVII.—Diurnal Range of the Barometer for each Civil Day, with the Weekly and Monthly Means for 1843.

Civil Day.	Jan.	Feb.	March.	April.	May.	June.	July.	Aug.	Sept.	Oct.	Nov.	Dec.
	in.	in.	in.	in.	in.	in.	in.	in.	in.	in.	in.	in.
1	[.....]	0·238	0·326	0·149	0·047	0·325	0·125	0·133	0·153	[0·122]	0·260	0·202
2	0·060	·123	·195	[·311]	·209	·215	[·158]	·323	·049	·171	·083	·158
3	·558	·318	·146	·207	·400	·426	·278	·062	[·105]	·036	·360	[·308]
4	·121	·660	·066	·269	·290	[·248]	·103	·143	·212	·032	·455	·481
5	·392	[·250]	[·108]	·434	·068	·035	·332	·180	·112	·185	[·359]	·221
6	·396	·153	·060	·410	·123	·047	·274	[·111]	·070	·544	·444	·343
7	·404	·173	·128	·194	[·167]	·442	·062	·139	·029	·081	·388	·396
8	[0·452]	·073	·053	·434	·157	·509	·194	·084	·057	[·349]	·426	·309
9	1·044	·052	·123	[·251]	·183	·460	[·161]	·059	·102	·406	·350	·077
10	0·329	·049	·299	·081	·182	·597	·141	·091	[·160]	·239	·368	[·200]
11	·146	·052	·152	·058	·131	[·281]	·121	·034	·412	·640	·456	·229
12	·129	[·163]	[·232]	·330	·291	·021	·173	·041	·142	·472	[·326]	·108
13	·858	·287	·133	·206	·178	·053	·025	[·062]	·221	·106	·104	·079
14	·570	·159	·324	·334	[·167]	·045	·076	·075	·157	·250	·152	·232
15	[·444]	·381	·364	·153	·033	·051	·159	·082	·065	[·313]	·527	·214
16	·713	·147	·249	[·167]	·071	·074	[·200]	·052	·086	·244	·203	·154
17	·087	·337	·103	·088	·297	·083	·519	·053	[·165]	·363	·526	[·160]
18	·310	·049	·206	·089	·127	[·098]	·304	·102	·318	·443	·129	·044
19	·074	[·120]	[·226]	·130	·052	·122	·117	·302	·152	·139	[·374]	·110
20	·267	·054	·448	·156	·130	·088	·285	[·267]	·215	·472	·284	·207
21	·247	·063	·230	·076	[·092]	·168	·271	·510	·292	·283	·445	·218
22	[·210]	·069	·122	·130	·060	·096	·295	·367	·219	[·243]	·655	·436
23	·348	·138	·278	[·266]	·044	·048	[·211]	·269	·083	·283	·175	·286
24	·118	·129	·275	·509	·141	·037	·197	·184	[·205]	·249	·276	[·204]
25	·204	·047	·232	·509	·196	[·086]	·044	·087	·133	·030	·121	·112
26	·153	[·200]	[·170]	·214	·155	·120	·175	·152	·342	·226	[·364]	·059
27	·297	·132	·063	·203	·073	·128	·046	[·222]	·162	·228	·619	·113
28	·285	·427	·091	·180	[·142]	·085	·256	·333	·119	·724	·482	·048
29	[·294]		·081	·332	·122	·062	·383	·464	·194	[·332]	·509	·156
30	·395		·669	[·228]	·088	·046	[·205]	·115	·183	·274	·446	·385
31	·397		·139		·218		·092	·037		·283		[·175]
Mean	0·342	0·180	0·206	0·235	0·151	0·169	0·194	0·166	0·165	0·285	0·355	0·207

The diurnal ranges have been obtained, in the first week in January, by taking the differences of the highest and lowest readings included between the first observation on the civil day and the first observation of the next civil day; the range for the 7th (Saturday) was obtained by including the last observation on the 6th. For the remainder of the year, the range for Mondays was obtained by including the first observations of Tuesday, and the range for the other days of the week by including the last observations of the previous days.

Mean of the Diurnal Ranges of the Atmospheric Pressure.—The diurnal ranges are least in May, the mean for that month being 0·151 in., and greatest in November, the mean being 0·355 in. The following are means for the three classes of groups, namely,

The mean meteorological seasons, for which June, July, and August constitute summer.
 The meteorological seasons for the year 1843, for which July, August, and September constitute summer.
 The astronomical seasons, for which May, June, and July constitute summer.

Seasons.	Mean Meteorological.	Meteorological for 1843.	Astronomical.
	in.	in.	in.
Spring,	0·197	0·185	0·207
Summer,	·176	·175	·171
Autumn,	·268	·282	·205
Winter,	·243	·243	·301
Range of Means,	0·092	0·107	0·130

The diurnal ranges are least for Summer of all the groups, and greatest for Autumn in the two meteorological groups, but greatest for Winter of the astronomical group. The latter group seems the most distinct, the difference of the means is also greatest for it.

The mean of all the diurnal ranges for the year 1843 = 0·221 inch.

TABLE XVIII.—Hourly Means of the Height of the Barometer for each Month and Quarter of 1843.

Period.	18h.	20h.	22h.	0h.	2h.	4h.	6h.	8h.	10h.	Mean Pressure.	Range.
	in.	in.	in.	in.	in.	in.	in.	in.	in.	in.	in.
January	29·333	29·353	29·363	29·365	29·353	29·357	29·358	29·367	29·374	29·357	0·041
February	·474	·482	·501	·511	·498	·493	·501	·515	·520	·499	·046
March	·647	·662	·669	·670	·662	·656	·658	·670	·672	·662	0·25
April	·480	·484	·486	·484	·477	·472	·477	·494	·507	·487	·035
May	·633	·636	·634	·628	·619	·606	·598	·607	·610	·620	·038
June	·614	·621	·624	·627	·624	·616	·608	·613	·622	·619	·019
July	·641	·641	·641	·642	·633	·629	·622	·627	·632	·635	0·20
August	·662	·669	·668	·660	·652	·641	·635	·645	·657	·656	·034
September	·926	·941	·949	·944	·933	·926	·926	·935	·941	·935	·023
October	·402	·414	·419	·415	·407	·394	·389	·391	·391	·401	·030
November	·431	·441	·460	·470	·476	·481	·493	·499	·503	·471	·072
December	·962	·962	·975	·977	·959	·953	·956	·957	·961	·962	·024
Spring	·587	·594	·596	·594	·586	·578	·578	·590	·596	·590	·018
Summer	·639	·644	·644	·643	·636	·629	·622	·628	·637	·637	·022
Autumn	·586	·599	·609	·610	·605	·600	·603	·608	·612	·602	·026
Winter	·590	·599	·613	·618	·603	·601	·605	·613	·618	·606	·028
The Year	·600	·609	·616	·616	·608	·602	·602	·610	·616	·609	·016

The observations in the first week of January were not made use of in obtaining the hourly means for

that month; no observations having been made at 18^h in the second week, a correction was applied to the mean for that hour of -0.327 in., obtained from Table XV. as follows:—

{Mean pressure, Jan. 9—31, = 29.271 in. *minus* mean pressure, Jan. 16—31, = 29.598 in.} = -0.327 in.

The means were afterwards corrected by $+0.090$ in., in order to render the mean for the month from these means equal to that obtained, Table XV., from all the daily means.

Diurnal Variation of the Atmospheric Pressure.—The means for the majority of the months indicate the existence of two maxima and two minima; the periods of only one maximum and one minimum can be determined from the nine observations. The means for the month of November present the greatest departure from the usual diurnal variation; in that month the pressure increases continuously from 5 A.M. till 9 P.M. The following are the periods of the maximum and minimum, included in the observations from 5 A.M. till 9 P.M., for the mean meteorological and astronomical seasons.

	Mean Meteorological Seasons.		Astronomical Seasons.	
	Maximum.	Minimum.	Maximum.	Minimum.
Spring, . . .	9 ^h 10 ^m A.M.	4 ^h 10 ^m P.M.	10 ^h 40 ^m A.M.	3 ^h 30 ^m P.M.
Summer, . . .	9 ^h 0 ^m A.M.	5 ^h 10 ^m P.M.	9 ^h 0 ^m A.M.	5 ^h 0 ^m P.M.
Autumn, . . .	10 ^h 20 ^m A.M.	3 ^h 20 ^m P.M.	8 ^h 40 ^m A.M.	4 ^h 50 ^m P.M.
Winter, . . .	10 ^h 50 ^m A.M.	2 ^h 40 ^m P.M.	10 ^h 40 ^m A.M.	2 ^h 0 ^m P.M.

The maximum seems to occur earliest in the warmest quarter, and the minimum latest in the same quarter; the maximum also occurs latest in the coldest quarter, and the minimum earliest in the same quarter. In the meteorological group, the principal maximum occurs at or after 9^h 10^m P.M. for Spring, Autumn, and Winter, and the principal minimum occurs at or before 5^h 10^m A.M. in Autumn and Winter.

In the mean for the year,

The principal minimum occurs at or before	5 ^h 10 ^m A.M.	Makerstoun mean time.
A maximum occurs at	10 ^h 10 ^m A.M.
A minimum occurs at	4 ^h 10 ^m P.M.
A maximum occurs at or after	9 ^h 10 ^m P.M.

The pressure at 5^h 10^m A.M. is very little less than that at 4^h 10^m P.M., and the pressure at 9^h 10^m P.M. is exactly the same as at 9^h 10^m A.M., and 11^h 10^m A.M.

The mean pressure for the year occurs at	7 ^h 10 ^m A.M.
.....	0 ^h 54 ^m P.M.
.....	6 ^h 54 ^m P.M.

The interval between the first two periods is 5^h 44^m
 second two periods is 6^h 0^m

Range of the Mean Diurnal Variation of Atmospheric Pressure.—The greatest diurnal range for any month is that for November, being 0.072 in.; the least is that for June, being 0.019 in. The diurnal range is greatest in Winter and least in Summer. The diurnal range of the quarterly means is greatest in Winter (whatever mode of grouping be adopted); it is least in Spring for the meteorological groups, and least in Summer of the astronomical group; the result for the latter is therefore the same as already obtained, Table XVII., for the mean of the diurnal ranges. The diurnal range of the means for the year 1843 is probably under 0.020 in., or about one-eleventh part of the mean of the diurnal ranges for the year.

TABLE XIX.—Extreme Readings of the Barometer for each Month ; Extreme Mean Daily Heights for each Month ; and Extreme Diurnal Ranges for each Month, together with the Ranges and Means of the Extremes.

Month.	Extreme Readings.								Extreme Daily Means.				Extreme Diurnal Ranges.					
	Highest.			Lowest.			Range.	Mean.	Highest.		Lowest.		Range.	Mean.	Greatest.		Least.	
	d.	h.	in.	d.	h.	in.	in.	in.	d.	in.	d.	in.	in.	in.	d.	in.	d.	in.
January	19	0	30.196	13	2	27.837	2.359	29.016	19	30.169	13	28.022	2.147	29.095	9	1.044	2	0.060
February	7	2	30.063	3	2	28.770	1.293	29.416	7	30.026	3	28.914	1.112	29.470	4	0.660	25	0.047
March	8	0	30.158	30	18	28.969	1.189	29.563	8	30.125	31	29.063	1.062	29.594	30	0.669	8	0.053
April	23	20	29.836	1	8	28.953	0.883	29.395	18	29.791	1	29.026	0.765	29.408	{24 25}	0.509	11	0.058
May	1	0	30.200	27	6	29.108	1.092	29.654	1	30.184	27	29.141	1.043	29.662	3	0.400	15	0.033
June	14	20	29.996	8	18	28.618	1.378	29.307	12	29.983	9	28.838	1.145	29.410	10	0.597	12	0.021
July	11	2	30.030	29	6	29.135	0.895	29.582	11	29.999	29	29.237	0.762	29.618	17	0.519	13	0.025
August	12	10	30.048	22	4	29.065	0.983	29.556	12	30.022	3	29.130	0.892	29.576	21	0.510	11	0.034
September	22	22	30.368	29	18	29.385	0.983	29.876	23	30.323	30	29.500	0.823	29.911	11	0.412	7	0.029
October	19	0	30.161	28	0	28.415	1.746	29.288	19	30.105	28	28.586	1.519	29.345	28	0.724	25	0.030
November	29	10	30.165	21	20	28.647	1.518	29.406	14	30.080	22	28.963	1.117	29.521	22	0.655	2	0.083
December	28	0	30.207	5	4	29.462	0.745	29.834	18	30.187	5	29.545	0.642	29.866	4	0.481	18	0.044

Extremes of Atmospheric Pressure for 1843.

Highest barometer occurred ... September 22^d 22^h = 30.368 } Range = 2.531, mean = 29.102.
 Lowest January 13^d 2^h = 27.837 }

Highest daily mean occurred... September 23^d = 30.323 } Range = 2.301, mean = 29.172.
 Lowest January 13^d = 28.022 }

Highest monthly mean occurred December = 29.963 } Range = 0.605, mean = 29.660.
 Lowest January = 29.358 }

The greatest diurnal range of pressure occurred January 9^d, = 1.044.
 The least June 12^d, = 0.021.
 The greatest range of pressure for a month occurred January 13^d—19^d, = 2.359.
 The least December, = 0.745.
 The greatest range of mean *daily* pressure for a month occurred January 13^d—19^d, = 2.147.
 The least December, = 0.642.

The mean of the highest and lowest readings in the year is 0.507 in. less than the mean for the year ; the mean of the highest and lowest daily means is 0.437 in. less than the mean for the year. If we compare similarly the means of the highest and lowest readings and daily means in each month with the monthly means, we obtain the following results :—

Monthly Means minus Mean of Highest and Lowest Readings in each Month.

Jan.	Feb.	March.	April.	May.	June.	July.	Aug.	Sept.	Oct.	Nov.	Dec.
in.	in.	in.	in.	in.	in.	in.	in.	in.	in.	in.	in.
+ 0.341	+ 0.083	+ 0.099	+ 0.092	- 0.034	+ 0.312	+ 0.053	+ 0.100	+ 0.059	+ 0.113	+ 0.065	+ 0.128

Monthly Means minus Mean of Highest and Lowest Daily Means in each Month.

Jan.	Feb.	March.	April.	May.	June.	July.	Aug.	Sept.	Oct.	Nov.	Dec.
in.	in.	in.	in.	in.	in.	in.	in.	in.	in.	in.	in.
+ 0.262	+ 0.029	+ 0.068	+ 0.079	- 0.042	+ 0.209	+ 0.017	+ 0.080	+ 0.024	+ 0.056	- 0.050	+ 0.096

The monthly means exceed the means of the highest and lowest readings in each month excepting May, the mean of the twelve monthly maxima and minima being 0·118 in. less than the mean for the year.

The monthly means exceed the means of the highest and lowest daily means in each month with the exceptions of May and November; the mean of the twelve monthly maxima and minima of daily means being 0·069 in. less than the mean for the year.*

TABLE XX.—Daily, Weekly, and Monthly Means of the Pressure of the Dry Air in 1843.

Civil Day.	Jan.	Feb.	March.	April.	May.	June.	July.	Aug.	Sept.	Oct.	Nov.	Dec.
	in.	in.	in.	in.	in.	in.	in.	in.	in.	in.	in.	in.
1	[.....]	29·035	29·468	28·704	29·920	29·009	29·184	29·102	29·576	[29·353]	29·322	29·712
2	29·747	28·910	29·714	[28·968]	29·814	28·700	[29·159]	28·854	29·549	29·400	29·409	29·640
3	29·710	28·748	29·849	29·097	29·436	28·911	29·067	28·716	[29·637]	29·443	29·126	[29·577]
4	29·263	29·296	29·951	28·906	29·113	[29·094]	29·315	28·773	29·756	29·371	29·032	29·624
5	29·440	[29·359]	[29·824]	29·129	29·045	29·429	28·987	29·080	29·808	29·298	[29·140]	29·277
6	29·502	29·678	29·685	29·049	29·025	29·392	28·983	[29·132]	29·565	28·787	29·144	29·583
7	29·072	29·785	29·781	28·783	[29·286]	29·127	29·195	29·403	29·676	28·697	28·982	29·368
8	[28·917]	29·738	29·962	28·904	29·328	28·515	29·300	29·340	29·638	[28·964]	29·148	29·607
9	28·763	29·792	29·914	[29·224]	29·478	28·504	[29·347]	29·482	29·543	29·062	29·411	29·689
10	28·266	29·800	29·596	29·528	29·727	29·107	29·480	29·565	[29·574]	29·262	29·078	[29·650]
11	28·458	29·830	29·589	29·612	29·711	[29·175]	29·648	29·567	29·319	28·680	29·557	29·656
12	28·528	[29·593]	[29·413]	29·465	29·495	29·687	29·477	29·569	29·618	28·858	[29·543]	29·820
13	27·820	29·605	29·012	29·528	29·141	29·644	29·410	[29·488]	29·646	29·112	29·716	29·757
14	28·233	29·416	28·995	29·185	[29·320]	29·596	29·412	29·492	29·403	29·360	29·883	29·657
15	[28·847]	29·117	29·373	29·463	29·101	29·621	29·341	29·372	29·309	[29·223]	29·612	29·562
16	29·261	28·972	29·497	[29·423]	29·103	29·583	[29·303]	29·357	29·363	29·201	29·588	29·837
17	29·548	29·277	29·236	29·487	29·369	29·557	29·440	29·349	[29·429]	29·164	29·111	[29·754]
18	29·692	29·443	29·368	29·511	29·602	[29·544]	29·105	29·374	29·390	29·644	28·858	29·902
19	29·875	[29·174]	[29·198]	29·362	29·639	29·536	29·109	29·150	29·702	29·928	[28·983]	29·874
20	29·776	29·160	29·301	29·248	29·489	29·588	28·975	[29·136]	29·406	29·518	28·848	29·694
21	29·556	29·107	28·925	29·241	[29·417]	29·377	29·023	29·268	29·532	29·331	28·771	29·776
22	[29·475]	29·082	28·859	29·233	29·251	29·490	28·965	28·747	29·882	[29·319]	28·724	29·476
23	29·292	29·167	28·947	[29·230]	29·277	29·492	[29·226]	28·931	29·943	29·214	28·970	29·611
24	29·084	29·328	29·333	29·537	29·243	29·514	29·485	29·167	[29·703]	29·002	29·157	[29·720]
25	29·265	29·374	29·637	29·031	28·989	[29·419]	29·559	29·137	29·818	28·921	29·209	29·805
26	29·353	[29·203]	[29·463]	29·091	28·884	29·420	29·350	29·236	29·671	29·078	[29·201]	29·808
27	29·030	28·846	29·618	29·345	28·813	29·331	29·368	[29·270]	29·372	29·095	28·776	29·842
28	29·036	29·034	29·600	29·126	29·149	24·269	29·293	29·107	29·405	28·322	29·348	29·899
29	[29·081]		29·646	29·304	29·469	29·227	28·838	29·357	29·417	[28·990]	29·747	29·787
30	29·001		29·212	[29·491]	29·499	29·172	[29·109]	29·611	29·082	29·058	29·626	29·511
31	29·030		28·764		29·238		29·199	29·566		29·063		[29·463]
Mean	29·138	29·314	29·438	29·235	29·341	29·300	29·250	29·247	29·553	29·149	29·237	29·683

This Table has been formed by subtracting Table IX. from Table XV.

Annual Variation of the Pressure of Dry Air.—The pressure of the dry air is least in January, being 29·138 in.; it increases from thence till March, then diminishes in April; after a slight increase in May it diminishes till August, the pressure being nearly the same in that month as in April; it then increases considerably in September, and diminishes to a greater extent in October and November; the greatest pressure occurs in December, being 29·683 in. The range of the monthly means is therefore 0·545 in. If the pressure in December be kept out of view, the annual variation for 1843 indicates maxima in the equinoctial months, and minima near the solstices. The following are the means for the three different groups, namely,

* I have pointed out elsewhere (Transactions of Sections, Report of Brit. Assoc. 1845, p. 15), that the means of the monthly maxima and minima are probably always less than the mean pressure in certain latitudes (including 50° and 60° north), but that in other latitudes the reverse is the case. The explanation of this fact will probably be found in the prevalence and excessive pressures of particular winds.

The mean meteorological seasons, for which June, July, and August constitute summer.

The meteorological seasons for the year 1843, for which July, August, and September constitute summer.

The astronomical seasons, for which May, June, and July constitute summer.

Seasons.	Mean Meteorological. in.	Meteorological for 1843. in.	Astronomical. in.
Spring, . . .	29·338	29·292	29·329
Summer, . . .	·266	·350	·297
Autumn, . . .	·313	·356	·316
Winter, . . .	·378	·297	·353
Range of Means, . . .	0·112	0·064	0·056

For the mean meteorological and astronomical seasons, the dry air is greatest in Winter and least in Summer ; but the meteorological seasons for 1843 give the pressure greatest in Autumn and least in Spring, and do not shew any distinct connexion between the pressure and temperature. Such a connexion, indeed, is not perceptible in the monthly means ; the high value of the winter means is due to the high pressure in December, a month, in as far as temperature is concerned, more autumnal than hibernal.

The mean pressure of the dry air for 1843 = 29·324 in.

TABLE XXI.—Hourly Means of the Pressure of Dry Air for each Month and Quarter of 1843.

Period.	18 ^h .	20 ^h .	22 ^h .	0 ^h .	2 ^h .	4 ^h .	6 ^h .	8 ^h .	10 ^h .	Mean.	Range.
	in.	in.	in.	in.	in.	in.	in.	in.	in.	in.	in.
January	29·121	29·140	29·153	29·151	29·134	29·136	29·136	29·156	29·166	29·144	0·045
February	·296	·305	·325	·331	·314	·308	·318	·336	·337	·319	·041
March	·446	·455	·448	·434	·423	·421	·427	·447	·454	·442	·034
April	·249	·236	·223	·224	·212	·211	·218	·238	·263	·237	·052
May	·369	·356	·347	·336	·330	·313	·313	·323	·331	·339	·056
June	·306	·304	·303	·305	·288	·284	·275	·295	·310	·300	·035
July	·277	·248	·243	·238	·226	·234	·219	·235	·254	·248	·058
August	·307	·277	·245	·216	·209	·206	·198	·212	·242	·245	·109
September	·602	·581	·553	·530	·516	·521	·512	·533	·561	·554	·090
October	·169	·173	·168	·151	·149	·135	·137	·148	·154	·156	·038
November	·201	·206	·221	·228	·227	·242	·261	·267	·274	·236	·073
December	·689	·689	·700	·689	·670	·668	·679	·684	·688	·685	·032
Spring	·355	·349	·339	·331	·322	·315	·320	·336	·349	·340	·040
Summer	·297	·277	·263	·253	·241	·242	·231	·247	·269	·265	·066
Autumn	·324	·320	·314	·303	·297	·299	·304	·316	·330	·315	·033
Winter	·369	·378	·392	·390	·372	·371	·377	·392	·396	·382	·027
The Year	·336	·331	·328	·320	·309	·307	·308	·323	·337	·326	·030

This Table has been formed by subtracting Table XI. from Table XVIII.

Diurnal Variation of the Pressure of Dry Air.—An examination of the monthly means will shew that they may be separated into two classes, namely, months in which two maxima and minima are visible, and months in which it is probable that only one maximum and minimum occur ; the same division was noticed in the case of the total atmospheric pressure. One month, September, which shews a double maximum and minimum of total pressure, shews only one of each for the dry air. The months in which double maxima and minima evidently occur are January, February, March, June, November, and December. A secondary and apparently accidental maximum occurs at 3 p.m. in some months.

On the whole, the Winter months present two and the Summer months only one maximum and minimum ; this is also evident in the means of groups.

Mean Meteorological Seasons.

Spring,	The maximum between 9 ^h P.M. and 5 ^h A.M. The minimum at 3 ^h 30 ^m P.M.
Summer,	{ The maximum before 5 ^h A.M. A secondary minimum about 2 ^h P.M. A secondary maximum about 3 ^h 20 ^m P.M. The minimum about 5 ^h P.M.
Autumn,	The maximum between 9 ^h P.M. and 5 ^h A.M. The minimum about 1 ^h 40 ^m P.M.
Winter,	{ The maximum after 9 ^h P.M. The minimum before 5 ^h A.M. A maximum at 9 ^h 40 ^m A.M. A minimum at 2 ^h 20 ^m P.M.

Astronomical Seasons.

Spring,	{ The maximum after 9 ^h P.M. A minimum before 5 ^h A.M. A maximum at 8 ^h 10 ^m A.M. The minimum at 2 ^h 40 ^m P.M.
Summer,	The maximum before 5 ^h A.M. The minimum at 4 ^h 40 ^m P.M.
Autumn,	The maximum before 5 ^h A.M. The minimum about 4 ^h 20 ^m P.M.
Winter,	{ The maximum after 9 ^h P.M. The minimum before 5 ^h A.M. A maximum at 9 ^h 40 ^m A.M. A minimum at 1 ^h 40 ^m P.M.

The diurnal variation for the year 1843 gives—

The maximum between 9 P.M. and 5 A.M.
The minimum at 3^h 20^m P.M.

The division, then, of the total pressure of the atmosphere into two parts, namely, the dry air and aqueous vapour, indicates only a single maximum and minimum in the diurnal curve *for the year* (as has been shewn by M. DOVE and Colonel SABINE). The minimum pressure of dry air takes place nearly two hours after the maximum temperature. We have still the double maximum and minimum in the Winter months. Why are both exhibited in the pressure of the dry air in Winter? We have seen that the diurnal range of the aqueous vapour follows, to some extent, the diurnal range of temperature, and that it is greater in Summer than in Winter. We have also seen that, for the year 1843, the diurnal variation of the total atmospheric pressure has a greater range in Winter than in Summer. It seems curious that the diurnal range of total pressure should diminish when the ranges of its two components increase, and that, when the diurnal ranges of the two components diminish, the diurnal range of the compound pressure should increase. There is no difficulty in seeing, even if the theory be at fault, or if the pressure of aqueous vapour be inaccurately determined, that the comparatively great diurnal range of aqueous vapour pressure for the summer months, and for the year, will swamp the smaller range of the total pressure, and produce a curve for the dry air, with a single maximum and minimum, inverse to that for the pressure of aqueous vapour. The fact that, when the diurnal range of the aqueous vapour pressure is least, namely, in Winter, the diurnal range of the total pressure is greatest, and the double maximum and minimum most distinctly marked both for the assumed dry air and total pressures, leave this mode of resolution with its original difficulties.

It was pointed out, Table XI., that a secondary maximum and minimum of the pressure of aqueous vapour occurred in several months about 1^h, 3^h, and 5^h P.M. No such periods were observed for the humidity or total atmospheric pressure. Of course, then, in assuming the total pressure to be composed of the pressures of dry air and of aqueous vapour (as calculated), we may expect to find the dry air accommodating itself to the calculated vapour pressure. Accordingly, as has been noticed above, secondary minima and maxima of dry air occur at the same times as the secondary maxima and minima of aqueous vapour. This does not seem very probable.

TABLE XXII.—Extremes of the Mean Daily Pressures of Dry Air, with their Ranges and Means.

Month.	Highest.		Lowest.		Range.	Mean.	Monthly Mean <i>minus</i> Mean.
	d.	in.	d.	in.	in.	in.	
January	19	29.875	13	27.820	2.055	28.847	+ 0.297
February	11	29.830	3	28.748	1.082	29.289	+ 0.030
March	8	29.962	31	28.764	1.198	29.364	+ 0.079
April	11	29.612	1	28.704	0.908	29.158	+ 0.079
May	1	29.920	27	28.813	1.107	29.366	- 0.027
June	12	29.687	9	28.504	1.183	29.095	+ 0.205
July	11	29.648	29	28.838	0.810	29.243	+ 0.005
August	30	29.611	3	28.716	0.895	29.163	+ 0.082
September	23	29.943	30	29.082	0.861	29.512	+ 0.042
October	19	29.928	28	28.322	1.606	29.125	+ 0.031
November	14	29.883	22	28.724	1.159	29.303	- 0.067
December	18	29.902	5	29.277	0.625	29.589	+ 0.096

This Table has been formed from Table XX.

The highest mean daily pressure of dry air occurred March 8^d = 29.962^{in.} }
 The lowest Jan. 13^d = 27.820^{in.} } Range = 2.142, Mean = 28.891.^{in.}

This mean is 0.433 in. less than the mean for the year.

The mean of the 12 monthly maxima and minima of the daily means is 0.071 in. less than the mean for the year.

The greatest monthly range of the daily means occurred January 13—19 = 2.055.^{in.}
 The least December = 0.625.

The ranges and means give nearly the same results as have been obtained for the total atmospheric pressure.

TABLE XXIII.—Daily, Weekly, and Monthly Means of the Pressure of Wind in Pounds on the Square Foot of Surface, deduced from the greatest Pressures occurring *between* the Two Hourly Observations.

Civil Day.	Jan.	Feb.	March.	April.	May.	June.	July.	Aug.	Sept.	Oct.	Nov.	Dec.
	lb.	lb.	lb.	lb.	lb.	lb.	lb.	lb.	lb.	lb.	lb.	lb.
1	[.....]	4.24	0.52	1.04	0.30	0.40	1.56	1.20	0.11	[0.69]	0.02	0.07
2	0.50	3.96	0.54	[0.81]	0.28	0.50	[1.14]	0.92	0.28	1.27	0.01	0.47
3	0.50	3.42	0.23	0.62	0.17	1.18	3.20	0.42	[0.22]	0.34	0.06	[1.72]
4	2.20	5.97	0.18	0.52	0.35	[0.64]	0.59	0.03	0.64	0.67	1.31	1.32
5	2.00	[2.67]	[0.23]	0.73	2.47	1.04	0.26	1.35	0.15	0.37	[1.08]	3.96
6	1.00	1.29	0.15	0.64	0.67	0.31	0.99	[0.44]	0.12	1.48	1.80	3.90
7	3.50	0.98	0.27	0.74	[0.92]	0.39	0.22	0.39	0.16	1.35	1.66	2.96
8	[2.18]	0.42	0.00	0.85	0.72	2.57	0.14	0.42	0.02	[0.57]	1.67	1.48
9	2.06	2.10	0.19	[1.05]	0.89	1.70	[0.46]	0.02	0.12	0.11	0.40	0.10
10	3.52	1.80	0.05	0.90	0.45	1.62	0.42	0.06	[0.12]	0.01	0.06	[1.27]
11	0.99	0.74	0.20	1.22	0.25	[1.27]	0.35	0.19	0.12	0.09	0.22	0.41
12	0.00	[1.06]	[0.41]	1.94	0.13	0.43	0.62	0.26	0.12	3.42	[0.37]	0.35
13	1.88	0.17	1.37	1.27	0.99	0.57	0.23	[0.18]	0.16	1.40	0.15	2.31
14	2.72	1.43	0.35	2.41	[0.88]	0.71	0.47	0.28	0.14	0.41	0.32	3.18
15	[1.45]	0.12	0.31	1.02	0.78	0.47	1.22	0.25	0.32	[1.19]	1.09	3.23
16	1.22	0.05	0.47	[1.02]	1.57	0.32	[0.58]	0.07	0.57	0.12	0.25	0.40

TABLE XXIII.—Continued.

Civil Day.	Jan.	Feb.	March.	April.	May.	June.	July.	Aug.	Sept.	Oct.	Nov.	Dec.
	lb.	lb.	lb.	lb.	lb.	lb.	lb.	lb.	lb.	lb.	lb.	lb.
17	1.35	0.27	1.72	0.02	1.56	0.28	0.33	0.05	[0.44]	1.40	1.77	[1.25]
18	1.52	0.04	0.51	0.89	0.61	[0.43]	0.87	0.03	1.02	0.37	1.77	0.08
19	0.99	[0.68]	[0.69]	0.52	0.62	0.56	0.37	0.08	0.04	0.10	[1.52]	0.17
20	0.31	2.10	0.32	0.18	1.29	0.10	0.66	[0.42]	0.55	0.71	1.13	0.46
21	0.10	1.06	0.60	0.21	[0.66]	0.84	0.65	0.61	0.52	0.57	0.89	0.07
22	[1.14]	0.57	0.54	0.11	0.62	0.10	0.12	0.91	0.02	[1.01]	3.32	3.07
23	1.68	1.04	0.64	[0.78]	0.45	0.35	[0.39]	0.86	0.05	2.48	0.13	2.65
24	1.83	0.27	0.67	1.25	0.38	0.19	0.12	0.09	[0.29]	1.78	0.00	[1.30]
25	1.92	0.02	1.22	2.37	0.56	[0.59]	0.00	0.63	0.56	0.45	0.00	0.74
26	1.42	[0.71]	[0.81]	0.54	0.97	0.35	0.80	0.28	0.41	0.26	[1.23]	0.90
27	3.39	1.44	1.69	0.72	0.37	0.88	1.19	[0.42]	0.19	0.39	2.90	0.38
28	5.47	0.95	0.60	0.90	[0.50]	1.69	0.22	0.95	0.97	2.03	1.52	0.57
29	[4.16]		0.06	0.27	0.57	0.39	0.62	0.51	0.28	[0.49]	2.82	0.98
30	6.60		0.18	[0.44]	0.17	0.87	[0.73]	0.04	0.63	0.10	0.61	2.26
31	3.84		1.80		0.38		0.24	0.03		0.14		[0.80]
Mean	2.02	1.44	0.57	0.88	0.69	0.72	0.63	0.40	0.32	0.84	1.00	1.40

The means in this Table have been obtained from the daily observations by the following formula:—The observation at 18^h being that of the maximum pressure of wind which has occurred from 10^h of the previous evening (excepting Monday mornings, when it is the maximum pressure which has occurred from about noon of the previous day), the observation at 18^h may be used as the maximum pressure belonging to some one couple of hours in the previous morning (excepting on Mondays). M being the daily means of the maxima in the previous Table, S the sum of the nine daily observations, 10_p the maximum observed at the 10^h preceding the 18^h observation, 10_s the maximum observed at the 10^h succeeding the 18^h observation, then

$$M = \frac{S + 10_p + 20 + 10_s}{12}$$

For Mondays the means have been obtained by the formula

$$M = \frac{S' + 3 \times 20 + 10_s}{12}$$

where S' is the sum of the eight observations from 20^h till 10^h; the observation at 18^h obviously could not be used for the daily means on Mondays.

The means of the four daily observations were taken for the daily means in the first week of January.

Annual Variation of the Means of the Maximum Pressures of the Wind.—The greatest monthly mean is that for January, being 2.02 lb., and the least is that for September, being 0.32 lb. The pressure diminishes from January till March, when there is a minimum, the means for the four months following being greater; it increases from September to December. The following are the means for the three groups of seasons, namely,

The mean meteorological seasons, for which June, July, and August constitute summer.

The meteorological seasons for 1843, for which July, August, and September constitute summer.

The astronomical seasons, for which May, June, and July constitute summer.

Seasons.	Mean Meteorological.	Meteorological for 1843.	Astronomical.
	lb.	lb.	lb.
Spring,	0.71	0.76	0.96
Summer,	0.58	0.45	0.68
Autumn,	0.72	1.08	0.52
Winter,	1.62	1.34	1.47
Range of Means,	1.04	0.89	0.95

The pressure is greatest in the coldest quarter and least in the warmest quarter of 1843. The mean for the year of the maximum pressures = 0.91 lb.

TABLE XXIV.—Daily, Weekly, and Monthly Means of the Pressure of Wind in Pounds on the Square Foot of Surface, deduced from the greatest Pressures observed within 10^m at the hours of Observation.

Civil Day.	Jan.	Feb.	March.	April.	May.	June.	July.	Aug.	Sept.	Oct.	Nov.	Dec.
	lb.	lb.	lb.	lb.	lb.	lb.	lb.	lb.	lb.	lb.	lb.	lb.
1	[.....]	2.30	0.22	0.39	0.22	0.25	1.06	0.47	0.00	[0.37]	0.00	0.00
2	0.10	2.50	0.28	[0.58]	0.18	0.33	[0.73]	0.43	0.12	0.73	0.00	0.28
3	0.20	2.08	0.07	0.35	0.06	0.52	2.31	0.20	[0.10]	0.12	0.00	[0.89]
4	1.07	4.54	0.08	0.27	0.25	[0.34]	0.26	0.01	0.41	0.47	0.77	0.51
5	0.87	[1.75]	[0.11]	0.42	1.51	0.55	0.10	0.56	0.04	0.17	[0.46]	2.79
6	0.52	0.84	0.03	0.35	0.14	0.10	0.42	[0.17]	0.02	0.94	0.67	1.55
7	1.32	0.54	0.18	0.21	[0.52]	0.27	0.08	0.15	0.07	0.60	0.82	1.66
8	[1.19]	0.02	0.00	0.40	0.55	1.71	0.02	0.07	0.01	[0.32]	0.50	0.68
9	1.16	1.39	0.12	[0.52]	0.46	0.91	[0.19]	0.01	0.03	0.03	0.12	0.02
10	2.88	0.71	0.00	0.39	0.22	0.93	0.22	0.02	[0.05]	0.00	0.00	[0.60]
11	0.38	0.44	0.11	0.56	0.15	[0.73]	0.14	0.07	0.05	0.16	0.05	0.15
12	0.00	[0.57]	[0.19]	1.22	0.04	0.21	0.28	0.07	0.07	2.02	[0.14]	0.12
13	1.29	0.07	0.72	0.47	0.47	0.27	0.07	[0.07]	0.07	0.36	0.06	0.98
14	2.47	0.80	0.12	1.86	[0.48]	0.36	0.23	0.12	0.07	0.15	0.13	2.14
15	[1.00]	0.00	0.05	0.62	0.42	0.22	0.67	0.12	0.21	[0.55]	0.47	1.90
16	0.57	0.02	0.15	[0.60]	0.93	0.23	[0.31]	0.02	0.34	0.04	0.02	0.12
17	0.85	0.19	0.79	0.00	0.86	0.18	0.13	0.00	[0.22]	0.66	1.58	[0.72]
18	0.81	0.00	0.12	0.51	0.24	[0.26]	0.57	0.01	0.45	0.08	0.41	0.02
19	0.58	[0.44]	[0.29]	0.13	0.37	0.33	0.21	0.02	0.01	0.07	[0.76]	0.02
20	0.02	1.42	0.12	0.07	0.93	0.02	0.31	[0.20]	0.27	0.38	0.40	0.14
21	0.02	0.66	0.20	0.10	[0.48]	0.60	0.33	0.27	0.18	0.17	0.73	0.01
22	[0.66]	0.35	0.34	0.07	0.42	0.06	0.07	0.52	0.00	[0.44]	1.40	1.98
23	0.73	0.80	0.25	[0.53]	0.18	0.18	[0.21]	0.40	0.00	1.17	0.02	1.24
24	1.13	0.02	0.46	0.83	0.77	0.12	0.06	0.04	[0.18]	0.54	0.00	[0.69]
25	1.47	0.00	0.86	1.92	0.22	[0.32]	0.03	0.28	0.28	0.32	0.00	0.34
26	0.87	[0.37]	[0.49]	0.21	0.47	0.17	0.46	0.11	0.19	0.12	[0.71]	0.41
27	2.48	0.97	1.16	0.42	0.07	0.52	0.55	[0.19]	0.46	0.16	1.57	0.17
28	4.77	0.22	0.23	0.42	[0.21]	0.86	0.07	0.51	0.52	1.36	0.90	0.34
29	[2.91]		0.00	0.13	0.23	0.13	0.27	0.18	0.13	[0.29]	1.75	0.22
30	5.00		0.10	[0.24]	0.03	0.50	[0.31]	0.00	0.24	0.05	0.19	0.93
31	2.07		1.93		0.25		0.09	0.03		0.05		[0.29]
Mean	1.29	0.87	0.32	0.49	0.39	0.40	0.35	0.17	0.16	0.42	0.48	0.72

The means in this Table have been obtained from the nine observations by the formula already given, Table I., for the temperature of the air. The daily means in the first week of January are the means of the four daily observations.

Annual Variation of the Means of the Maximum Pressures of Wind at the Hours of Observation.—Naming these pressures the *mean* pressures, for which they may be taken approximately, we find the same law of variation as for the *maximum* pressures. The *mean* pressure is greatest for January, the mean being 1.29 lb.; it diminishes till March, in which there is a minimum, the means for the four months following being greater; the least pressures occur in August and September, the mean for the latter being 0.16 lb.; the pressure then increases till December. The following are the means for the three groups of seasons:—

Seasons.	Mean Meteorological.	Meteorological for 1843.	Astronomical.
	lb.	lb.	lb.
Spring,	0.40	0.43	0.56
Summer,	0.31	0.23	0.38
Autumn,	0.35	0.54	0.25
Winter,	0.96	0.83	0.83
Range of Means,	0.65	0.60	0.58

The *mean* pressure is greatest for the mean meteorological winter, and least for the warmest quarter of 1843.

The *mean* pressure for the year 1843 = 0.50 lb.

The monthly means of the *maximum* pressures, Table XXIII., bear to the monthly means of the *mean* pressures, Table XXIV., the following ratios:—

Jan.	Feb.	March.	April.	May.	June.	July.	August.	Sept.	Oct.	Nov.	Dec.
1.57	1.66	1.78	1.80	1.77	1.80	1.80	2.35	2.00	2.00	2.08	1.98

The mean for the year of the *maximum* pressures is 1.82 times greater than the mean for the year of the *mean* pressures.

TABLE XXV.—Maximum Pressure of Wind in each Civil Day in 1843, with the Monthly Means.

Civil Day.	Jan.	Feb.	Mar.	April.	May.	June.	July.	Aug.	Sept.	Oct.	Nov.	Dec.
	lb.	lb.	lb.	lb.	lb.	lb.	lb.	lb.	lb.	lb.	lb.	lb.
1	2.0	6.8	1.0	2.8	0.8	0.9	3.0	2.3	0.2	2.4	0.1	0.8
2	1.2	6.2	1.2	0.8	0.6	1.0	3.8	2.2	0.5	2.4	0.0	2.0
3	1.0	5.5	0.5	2.0	0.5	1.6	5.1	1.2	3.6	0.7	0.2	2.5
4	3.0	12.8	0.5	1.2	0.9	1.8	1.3	0.2	1.1	1.9	2.4	3.0
5	3.0	1.8	2.5	2.8	4.8	1.5	0.9	3.2	0.4	0.8	4.5	7.6
6	1.5	2.5	0.8	2.5	2.8	0.6	2.2	2.2	0.7	2.7	2.8	5.5
7	5.8	2.0	1.2	1.5	2.6	1.1	0.6	1.5	0.6	2.8	4.2	4.9
8	3.5	2.2	0.0	2.2	1.7	3.6	0.5	1.5	0.2	3.8	3.4	3.2
9	3.8	3.5	0.5	1.0	1.4	2.9	0.6	0.1	0.6	0.5	0.7	0.2
10	6.0	3.2	0.2	2.8	0.9	3.5	1.7	0.2	0.3	0.1	0.5	0.7
11	5.5	1.2	0.5	3.2	0.8	1.7	0.7	0.7	0.6	0.8	0.5	1.2
12	0.0	0.8	1.8	5.5	0.6	0.7	1.9	0.6	0.5	7.5	0.7	1.1
13	3.5	0.8	5.0	2.5	2.0	1.2	0.5	0.3	0.5	4.1	0.3	3.6
14	7.5	3.0	0.8	4.0	1.2	1.4	1.1	1.0	0.4	0.8	1.0	6.1
15	2.0	0.5	0.8	2.0	1.2	0.8	2.6	0.8	0.6	1.2	3.8	7.5
16	1.8	0.2	1.2	0.8	2.4	1.0	2.6	0.3	2.1	0.2	0.5	0.8
17	3.0	1.0	2.8	0.5	2.5	0.4	0.6	0.5	0.7	3.1	3.9	3.1
18	3.0	0.5	1.2	2.0	1.2	0.5	3.4	0.2	2.7	0.9	4.5	0.3
19	1.8	1.5	1.2	1.0	1.4	1.0	1.3	0.3	0.2	0.4	2.6	0.3
20	1.2	3.8	0.5	0.8	1.9	0.2	1.3	1.1	1.2	1.5	5.1	1.1
21	0.8	2.5	1.8	0.5	1.7	1.5	1.6	1.2	1.0	1.6	3.8	0.2
22	1.5	0.8	2.5	0.5	0.8	0.3	0.6	2.0	0.1	4.2	7.2	7.3
23	3.0	1.2	2.0	1.5	1.0	1.2	6.1	1.9	0.2	4.7	0.3	5.2
24	3.5	0.8	2.2	3.0	2.8	0.5	0.4	0.4	0.3	4.2	0.0	3.4
25	3.2	0.2	3.0	4.8	1.6	0.5	0.2	1.9	2.0	0.7	0.0	2.2
26	2.5	1.2	4.0	0.8	1.6	0.5	1.9	0.6	1.1	0.6	4.3	3.0
27	6.0	2.5	2.8	2.2	0.7	2.0	2.3	1.4	2.1	1.0	4.7	0.8
28	9.0	2.0	1.2	1.8	3.0	2.8	0.7	2.9	2.4	4.1	4.7	1.8
29	5.0		0.5	0.7	2.0	1.5	1.9	1.3	0.7	6.1	4.8	1.7
30	9.8		0.5	1.5	0.7	1.9	1.7	0.2	1.6	0.3	2.2	3.7
31	7.2		3.8		0.9		0.9	0.2		0.3		4.2
Mean	3.60	2.54	1.56	1.96	1.58	1.34	1.74	1.11	0.97	2.14	2.46	2.87

If the maximum pressure observed at 18^h on Monday morning was greater than the maximum observed about noon on Sunday, the former was taken as the maximum for Sunday.

The monthly means of the maximum pressure of wind in each day follow nearly the same law as the monthly means, Tables XXIII. and XXIV.

TABLE XXVI.—Means of the Maximum Pressures of Wind between the Hours of Observation for each Month and Quarter of 1843.

Period.	10 ^h —18 ^h .	18 ^h —20 ^h .	20 ^h —22 ^h .	22 ^h —0 ^h .	0 ^h —2 ^h .	2 ^h —4 ^h .	4 ^h —6 ^h .	6 ^h —8 ^h .	8 ^h —10 ^h .	Range.
	lb.	lb.	lb.	lb.	lb.	lb.	lb.	lb.	lb.	lb.
January	2.56	2.29	2.07	2.42	2.40	1.94	1.71	2.08	1.60	0.82
February	1.96	1.32	1.61	1.40	1.50	1.60	1.79	1.20	1.11	0.68
March	0.89	0.39	0.43	0.67	0.97	1.00	0.71	0.43	0.41	0.61
April	0.87	0.61	1.04	1.26	1.33	1.38	1.12	0.78	0.56	0.82
May	0.86	0.47	0.69	0.86	1.02	1.07	1.06	0.82	0.52	0.60
June	0.75	0.56	0.72	0.78	1.08	1.02	0.92	0.82	0.53	0.55
July	0.85	0.37	0.64	0.75	0.95	1.09	0.91	0.72	0.46	0.72
August	0.37	0.16	0.42	0.54	0.80	0.74	0.62	0.50	0.28	0.64
September	0.40	0.18	0.35	0.60	0.71	0.71	0.47	0.22	0.16	0.55
October	1.60	0.76	0.80	1.25	1.30	0.94	0.79	0.62	0.62	0.68
November	1.48	1.03	1.09	1.38	1.41	1.11	0.72	0.53	0.69	0.88
December	1.93	1.19	1.48	1.41	1.60	1.33	1.42	1.58	1.35	0.41
Spring	0.87	0.49	0.72	0.93	1.11	1.15	0.96	0.68	0.50	0.66
Summer	0.66	0.36	0.59	0.69	0.94	0.95	0.82	0.68	0.42	0.59
Autumn	1.16	0.66	0.75	1.08	1.14	0.92	0.66	0.46	0.49	0.68
Winter	2.15	1.60	1.72	1.74	1.83	1.62	1.64	1.62	1.35	0.48
The Year	1.21	0.78	0.95	1.11	1.26	1.16	1.02	0.86	0.69	0.57

The observations in the first week of January were not made use of in obtaining the hourly means for that month in Tables XXVI. and XXVII. No observations having been made at 18^h in the second week, a correction was applied to the mean for that hour of -0.11 in Table XXVI., and of -0.14 in Table XXVII., obtained from Tables XXIII. and XXIV. as follows :—

$$\{\text{Mean pressure, January 9—31} = 2.21 \text{ minus mean pressure, January 16—31} = 2.32\} = -0.11.$$

$$\{\text{Mean pressure, January 9—31} = 1.43 \text{ minus mean pressure, January 16—31} = 1.57\} = -0.14.$$

The means for January in Tables XXVI. and XXVII. are further corrected by -0.15 and -0.10 respectively, in order to render the means for that month equal to those obtained Tables XXIII. and XXIV.

Diurnal Variation of the Maximum Pressure of Wind.—The means for the months of January, February, and December are very irregular, presenting two or three maxima and two or three minima within the nine daily observations; in the other months only one maximum is evident, occurring between 11 A.M. and 2 P.M. The minimum occurs after 9 P.M. and before 7 A.M. The following are the interpolated hours for the maximum for the mean meteorological and astronomical seasons, obtained on the assumption that the means correspond to the middle of the interval to which they belong; for example, that the mean of the maximum pressures occurring betwixt 0^h and 2^h correspond to 1^h :—*

Seasons.	Mean Meteorological.	Astronomical.
Spring,	1 ^h 20 ^m P.M.	1 ^h 40 ^m P.M. Makerstoun mean time.
Summer,	1 ^h 10 ^m P.M.	1 ^h 20 ^m P.M.
Autumn,	11 ^h 10 ^m P.M.	11 ^h 30 ^m A.M.
Winter,	0 ^h 10 ^m P.M.	11 ^h 30 ^m A.M.

The maximum pressures occur latest in the day in Spring, and earliest in Autumn and Winter.

A secondary minimum and maximum occur in Winter of the meteorological group about 2^h P.M. and 4^h P.M. respectively, and in Winter of the astronomical group about 4^h P.M. and 6^h P.M. respectively.

The maximum in the diurnal variation for the year occurs at 0^h 30^m P.M. The value of the maximum pressure increases regularly from 8^h 10^m A.M. till 0^h 30^m P.M. at the rate of 0.08 lb. per hour, and it diminishes from 0^h 30^m P.M. till 8^h 10^m at the same rate.

* This assumption is obviously inexact, as the means of the maximum pressures, while the pressure is increasing, will most probably belong to nearly the termination of the periods in which they occur, but since, while the pressure is diminishing, they will probably correspond to nearly the commencement of the periods, the interpolated time of maximum will not be affected by the error of the hypothesis.

TABLE XXVII.—Means of the Maximum Pressures of Wind within 10^m at the Hours of Observation for each Month and Quarter of 1843.

Period.	18 ^h .	20 ^h .	22 ^h .	0 ^h .	2 ^h .	4 ^h .	6 ^h .	8 ^h .	10 ^h .	Mean.	Range.
	lb.	lb.	lb.	lb.	lb.	lb.	lb.	lb.	lb.	lb.	lb.
January	1.23	1.33	1.62	1.77	1.40	1.15	1.16	1.07	1.10	1.28	0.70
February	0.87	0.80	0.75	1.10	1.15	1.13	0.86	0.62	0.70	0.86	0.53
March	0.29	0.18	0.31	0.50	0.60	0.61	0.22	0.14	0.21	0.32	0.47
April	0.37	0.46	0.63	0.85	0.89	0.58	0.63	0.24	0.26	0.49	0.65
May	0.20	0.33	0.44	0.56	0.71	0.65	0.70	0.36	0.20	0.40	0.51
June	0.24	0.32	0.50	0.62	0.62	0.61	0.50	0.39	0.30	0.41	0.38
July	0.25	0.28	0.48	0.39	0.56	0.67	0.41	0.32	0.15	0.34	0.52
August	0.05	0.07	0.27	0.33	0.34	0.31	0.33	0.16	0.06	0.17	0.29
September	0.06	0.07	0.27	0.40	0.44	0.32	0.09	0.03	0.07	0.16	0.41
October	0.48	0.35	0.44	0.62	0.68	0.48	0.33	0.24	0.23	0.41	0.45
November	0.57	0.52	0.40	0.82	0.57	0.50	0.33	0.21	0.37	0.47	0.61
December	0.75	0.71	0.78	0.58	0.95	0.62	0.67	0.98	0.55	0.71	0.43
Spring	0.29	0.32	0.46	0.64	0.73	0.61	0.52	0.25	0.22	0.40	0.51
Summer	0.18	0.22	0.42	0.45	0.51	0.53	0.41	0.29	0.17	0.31	0.36
Autumn	0.37	0.31	0.36	0.61	0.56	0.43	0.25	0.16	0.22	0.35	0.45
Winter	0.95	0.95	1.05	1.15	1.17	0.97	0.90	0.89	0.79	0.95	0.38
The Year	0.44	0.45	0.57	0.71	0.74	0.63	0.52	0.39	0.35	0.50	0.39

Diurnal Variation of the Mean Pressures of the Wind.—The means for the month of December are irregular, presenting three maxima and three minima within the nine observations; February, March, October, and November indicate two maxima and two minima in the twenty-four hours. The maximum pressure occurs, in general, about 1^h P.M. The following are the periods of the maxima for the mean meteorological and astronomical seasons:—

Seasons.	Mean Meteorological.	Astronomical.
Spring,	0 ^h 50 ^m P.M.	0 ^h 30 ^m P.M. Makerstoun mean time.
Summer,	2 ^h 50 ^m P.M.	2 ^h 20 ^m P.M.
Autumn,	11 ^h 40 ^m A.M.	0 ^h 40 ^m P.M.
Winter,	0 ^h 50 ^m P.M.	11 ^h 50 ^m A.M.

The periods for the astronomical group are the most distinct and regular; from these the maximum pressure of wind occurs latest in Summer, about an hour after the maximum temperature, and earliest in Winter, about an hour before the maximum temperature. In Spring and Autumn the maximum pressures occur about an hour before the maximum temperatures. In Autumn of the mean meteorological group a minimum of pressure occurs at 7^h 10^m A.M. and another at 7^h 10^m P.M.

In Spring of the astronomical group minima occur at 7^h 10^m A.M. and 7^h 10^m P.M.

In Autumn a minimum occurs at 7^h 10^m A.M.

In Winter a minimum occurs at 5^h 10^m P.M., and a maximum at 7^h 10^m P.M.

In the means for the year the maximum pressure occurs at 0^h 25^m P.M., or an hour before the maximum temperature of the air. The pressure increases regularly from 7^h 10^m A.M. till 0^h 25^m P.M., at the rate of 0.06 lb., and it diminishes from 0^h 25^m till 7^h 10^m at the same rate. The forenoon and afternoon branches of the mean diurnal curve are therefore straight lines, forming the same angle with the ordinates.

TABLE XXVIII.—Maximum Pressures of Wind, with the Maxima of the Daily Means, Tables XXIV. and XXV., and corresponding Directions of the Wind for each Month in 1843.

Month.	Maximum Pressure.					Max. of Daily Means of <i>Max.</i> Pressures.			Max. of Daily Means of <i>Mean</i> Pressures.		
	d.	h.	h.	lb.	Pt.	d.	lb.	Pt.	d.	lb.	Pt.
January	30	6—	8	9.8	NW.	30	6.60	W.	30	5.00	W.
February	3	20—	22	12.8	N by W.	4	5.97	N by W.	4	4.54	N by W.
March	13	0—	2	5.0	WNW.	31	1.80	SW by S.	31	1.93	SW by S.
April	12	4—	6	5.5	WNW.	14	2.41	W by S.	25	1.92	SW.
May	5	0—	2	4.8	S.	5	2.47	SSW.	5	1.51	SSW.
June	7	20—	22	3.6	S by W.	8	2.57	SSW.	8	1.71	SSW.
July	22	10—	24	6.1	NNE.	3	3.20	SW.	3	2.31	SW.
August	5	8—	10	3.2	WSW.	5	1.35	SW by W.	5	0.56	SW by W.
September	3	0—	18	3.6	W by S.	18	1.02	SW.	28	0.52	NNW.
October	11	10—	18	7.5	N by E.	12	3.42	NNW.	12	2.02	NNW.
November	21	22—	24	7.2	NW.	22	3.32	W.	29	1.75	WNW.
December	4	10—	18	7.6	SW.	5	3.96	SW.	5	2.79	SW.

The greatest pressure of the wind in the year 1843 occurred February 4^d 20^h—22^h, being 12.8 lb., the wind blowing from N. by W.

The greatest mean daily pressure occurred January 30^d, the wind blowing from W. ; being, for the maxima *between* the hours of observation, 6.6 lb., and for the maxima *at* the hours of observation (or *mean*), 5.0 lb.

The maximum pressure of the wind in three months occurs between 1^h P.M. and 9^h P.M.; the greater number of the monthly maxima seem to occur between midnight and noon.

The monthly maxima occurred on five months while the wind was blowing in the quadrant from N. to W. ; on four months while the wind was blowing from between S. and W. ; on one month while blowing from S. ; and on two months while blowing from between N. and E.

All the monthly maxima of the daily means occurred with winds from between NW. by W., and SSW.

TABLE XXIX.—Number of times which the Wind blew from each Point of the Compass at the together with the *sums* of the Pres-

Wind blowing from	January.		February.		March.		April.		May.		June.	
	Times.	Press.	Times.	Press.	Times.	Press.	Times.	Press.	Times.	Press.	Times.	Press.
N.	...	lb.	5	8.2	9	3.9	3	3.2	...	lb.	7	5.8
N by E.	10	13.1	2	0.4	5	3.4
NNE.	11	6.7	4	2.6	2	0.6	11	4.9
NE by N.	25	13.0	3	0.6	11	5.4	51	18.9
NE.	22	16.3	4	2.4	6	4.7	38	20.0	27	12.5
NE by E.	8	4.4	3	1.2	1	0.5	20	12.4	13	5.4
ENE.	12	13.5	12	11.7	2	0.6	24	16.9	14	4.7
E by N.	2	2.3	15	11.9	1	0.2	12	8.9
E.	4	1.1	2	0.7	6	4.3	1	0.1
E by S.	1	0.8	1	0.2	5	6.2
ESE.	1	0.5	1	0.1
SE by E.
SE.	3	6.5	1	0.2	3	1.6	2	1.2
SE by S.	1	3.0	3	1.2	1	0.3
SSE.	5	3.2	3	4.5
S by E.	8	7.3	6	3.3	8	8.8	3	1.5
S.	4	2.2	11	16.6	6	9.3	2	1.3
S by W.	3	2.5	2	0.7	2	2.0	5	6.6
SSW.	7	6.6	2	0.4	7	4.7	8	5.8	1	0.1
SW by S.	21	25.4	2	5.4	7	10.5	1	0.5	12	7.0	4	4.3
SW.	26	51.1	13	26.2	12	9.6	19	11.9	7	4.2	1	0.5
SW by W.	44	54.3	5	11.0	14	8.7	10	9.3	5	3.4	3	2.2
WSW.	7	7.8	5	2.6	9	6.8	6	2.8	7	4.7
W by S.	14	12.6	9	14.2	1	0.2	6	5.3
W.	15	33.9	2	0.4	6	7.7	10	9.0
W by N.	1	8.2	1	4.8	1	1.2	1	0.2
WNW.	4	18.3	4	1.6	3	2.4	4	5.2	1	0.6	2	2.4
NW by W.	5	21.9	1	1.5	2	2.7
NW.	8	18.8	6	7.4	3	2.2
NW by N.	8	14.6	2	7.0	6	3.5	2	3.0
NNW.	2	1.0	11	14.5	1	0.2	5	3.1	3	1.1
N by W.	3	2.8	15	41.9	6	1.5	5	3.8	2	1.8

Observation Hours, with a Pressure of one-tenth of a pound or upwards on a square foot of surface, sures for each Month in 1843.

July.		August.		September.		October.		November.		December.		Wind blowing from
Times.	Press.	Times.	Press.	Times.	Press.	Times.	Press.	Times.	Press.	Times.	Press.	
	lb.		lb.		lb.		lb.		lb.		lb.	
3	0.9	1	0.1	7	4.0	3	1.8	1	0.5	N.
2	0.3	2	0.5	4	7.7	N by E.
9	2.5	1	0.1	1	0.1	5	4.2	2	0.3	NNE.
3	1.2	1	0.1	3	0.5	1	0.2	2	0.4	NE by N.
2	0.2	3	0.6	9	2.0	6	1.1	NE.
5	1.4	3	0.5	2	0.7	NE by E.
2	0.3	3	0.8	6	1.1	ENE.
1	0.1	2	3.4	1	0.1	E by N.
2	0.6	3	4.4	E.
...	E by S.
1	0.2	1	0.1	ESE.
...	1	0.3	SE by E.
...	...	1	0.1	3	0.4	SE.
...	...	1	0.1	1	0.2	SE by S.
3	0.5	5	1.0	3	0.4	1	1.4	SSE.
...	...	5	3.6	2	2.0	2	0.9	S by E.
...	...	13	8.8	1	1.2	1	0.1	S.
2	0.7	5	3.7	1	1.2	2	2.5	3	0.4	3	0.6	S by W.
15	6.6	11	5.2	2	2.3	4	2.7	32	33.0	25	17.9	SSW.
17	11.1	17	8.8	2	1.0	11	5.2	5	1.8	19	20.0	SW by S.
45	41.0	24	12.0	14	6.3	32	19.3	31	19.8	90	91.1	SW.
9	4.5	6	3.2	6	1.6	16	7.3	4	4.6	1	2.6	SW by W.
8	4.4	6	1.6	5	1.2	17	5.9	8	6.5	18	13.3	WSW.
5	2.3	4	1.2	4	1.5	5	3.7	3	1.9	W by S.
9	5.2	3	1.1	8	2.6	8	7.2	5	5.2	10	19.3	W.
5	3.5	1	0.1	1	0.3	5	6.5	2	1.2	4	4.8	W by N.
...	...	2	0.3	1	0.1	5	4.2	4	9.9	WNW.
2	0.8	1	0.3	2	0.4	9	2.4	2	0.8	NW by W.
2	0.5	6	1.9	5	1.3	9	17.8	NW.
...	3	1.1	3	3.4	2	1.7	NW by N.
7	2.3	7	3.0	8	2.4	4	1.6	NNW.
2	0.3	9	8.1	3	4.7	3	0.9	N by W.

In forming the sums for January in Table XXIX., the following quantities, estimated from the four daily observations, were used as belonging to the first week in that month :—

Wind.	Times.	Sums of Pressure.	Wind.	Times.	Sums of Pressure.
		lb.			lb.
NNW.	1	0·2	W by S.	2	3·0
NW by W.	4	2·4	SW by W.	15	13·4
NW.	5	4·3	SSW.	5	3·2
W.	9	6·2			

Annual Variation of the number of times which the Wind blew, as deduced from the observations made at 9 two hourly intervals. The following are the sums of the times which the wind blew at the observation hours for each month, as obtained from Table XXIX. :—

Jan.	Feb.	March.	April.	May.	June.	July.	Aug.	Sept.	Oct.	Nov.	Dec.
177	149	127	135	170	187	161	113	113	159	126	173

The number of times which the wind blows is a maximum in January, the number diminishes to March when it is a minimum, it increases to June when it is a maximum, diminishes again to August and September when it is a minimum, and increases till December when the number is nearly the same as in January. The only exception to the regularity of this increase and diminution is in November, in which month the number is less than in October. In the year 1843 *the wind blew most frequently at the solstices and most seldom at the equinoxes*. The range of the variation of the numbers is 74, or $\frac{2}{3}$ of the greatest number, 187, that for June.

Annual Variation of the number of points of the compass in which the Wind blew.—The following are the number of points of the compass in which the wind blew for each month :—

Jan.	Feb.	March.	April.	May.	June.	July.	Aug.	Sept.	Oct.	Nov.	Dec.
17	17	24	27	20	25	24	21	29	24	20	9

The wind, therefore, seems to be least variable at the Winter solstice, and more variable at the equinoxes than at the summer solstice.

Annual Variation of the sums of the Pressure of the Wind.—This, of course, is the same as has been already obtained, Table XXIV., for the means of the pressures ; or the maximum near the winter solstice, minima at the equinoxes, and a secondary maximum near the summer solstice. The sums, as obtained from Table XXIX., are as follow :—

Jan.	Feb.	March.	April.	May.	June.	July.	Aug.	Sept.	Oct.	Nov.	Dec.
lb.	lb.	lb.	lb.	lb.	lb.	lb.	lb.	lb.	lb.	lb.	lb.
261·6	191·4	82·9	122·9	111·6	106·4	91·4	52·2	45·8	100·3	111·6	171·5

Annual Variation of the Mean Pressure of the Wind when blowing.—The means, Table XXIV., are the mean pressures throughout the 24 hours. The following means are obtained by dividing the sums of the pressures by the number of times which the wind blew :—

Jan.	Feb.	March.	April.	May.	June.	July.	Aug.	Sept.	Oct.	Nov.	Dec.
lb.	lb.	lb.	lb.	lb.	lb.	lb.	lb.	lb.	lb.	lb.	lb.
1·48	1·28	0·65	0·91	0·66	0·57	0·57	0·46	0·41	0·63	0·89	0·99

The mean pressure of the wind when blowing is a maximum in January and December ; it is a minimum in September. There is also a minimum in March, but it is not sufficiently marked to produce a distinct maximum near the summer solstice, as shewn by the *sums* of the pressures. From this the wind seems to blow with the greatest force near the coldest, and with the least force near the hottest period of the year. The range of the monthly means of the pressure of wind while blowing is 1·07 lb.

TABLE XXX.—Sums of the Pressures of Wind in Table XXIX., resolved for each Month and Quarter into the Four Cardinal Points of the Compass, together with the Value and Direction of the Resultant.

Period.	Resolved Sums in				Resultant.		
	N.	E.	S.	W.	Sums.	Means.	Directions.
	lb.	lb.	lb.	lb.	lb.	lb.	°
January	49.8	7.7	113.3	216.7	218.4	1.23	W. 17 S.
February	120.2	42.4	29.1	55.7	92.1	0.62	N. 8 W.
March	26.6	30.1	33.8	25.8	8.4	0.07	S. 31 E.
April	27.8	9.7	50.9	63.4	58.5	0.43	W. 23 S.
May	34.5	63.4	30.8	15.7	48.9	0.29	E. 4 N.
June	50.7	32.8	21.6	30.9	29.2	0.16	N. 4 E.
July	9.4	4.5	50.2	58.6	67.8	0.42	W. 37 S.
August	1.6	2.9	40.0	22.0	42.9	0.38	S. 26 W.
September	20.4	4.6	14.5	17.7	14.4	0.13	W. 24 N.
October	29.7	11.9	30.6	55.2	43.3	0.27	W. 1 S.
November	21.9	0.9	53.5	71.6	76.5	0.61	W. 24 S.
December	0.9	0.0	105.0	122.9	161.1	0.93	W. 40 S.
Mean Met. Qrs.							
Spring	88.9	103.2	115.5	104.9	26.7	0.06	S. 4 W.
Summer	61.7	40.2	111.8	111.5	87.1	0.19	W. 35 S.
Autumn	72.0	17.4	98.6	144.5	129.9	0.33	W. 12 S.
Winter	170.9	50.1	247.4	395.3	353.6	0.71	W. 13 S.
Astron. Qrs.							
Spring	174.6	82.2	113.8	144.9	87.3	0.21	W. 44 N.
Summer	94.6	100.7	102.6	105.2	9.2	0.02	S. 29 W.
Autumn	51.7	19.4	85.1	94.9	82.6	0.21	W. 24 S.
Winter	72.6	8.6	271.8	411.2	449.2	0.94	W. 26 S.
The Year	393.5	210.9	573.3	756.2	574.2	0.32	W. 18 S.

The mean resultants are obtained from the sum resultants in dividing the latter by the numbers of times which the wind blew.

Annual Variation of the Resultant Pressure of the Wind.—The resultant sums and means of pressures are the maximum in January and the minimum in March, a secondary minimum occurs in June, secondary maxima occurring in the months before and after it, and a minimum occurs in September, differing little in value from that for March; the resultant increases from thence till December. The quarterly periods for the astronomical group seem most regular. The resultant is nearly zero for the astronomical summer, it has about equal values in Spring and Autumn, and it is greatest in Winter.

The direction of the Resultant is between S. and W. seven months of the year, namely, in January, April, July, August, October, November, and December; it is between N. and W. two months, namely, in February and September; it is between N. and E. two months, namely, in May and June; and it is between S. and E. one month, namely, March.

The direction of the resultant wind for 1843 is W. 18° S.

TABLE XXXI.—Number of times which the Wind blew from each Point of the Compass at foot of surface, together with

Wind blowing from	18 ^h .		20 ^h .		22 ^h .		0 ^h .		2 ^h .		4 ^h .	
	Times.	Press.	Times.	Press.	Times.	Press.	Times.	Press.	Times.	Press.	Times.	Press.
N.	2	1.1	3	2.2	3	0.5	6	4.7	7	4.8	7	4.8
N by E.	3	5.4	3	2.6	3	3.2	3	4.4	2	0.4	2	2.3
NNE.	2	0.3	6	2.0	4	2.0	6	2.8	7	4.8	6	4.7
NE by N.	12	5.4	12	3.8	14	4.1	10	4.3	11	4.7	12	5.9
NE.	9	3.0	8	4.0	10	6.5	12	7.6	12	6.2	18	11.9
NE by E.	1	1.0	7	3.2	3	1.9	9	4.1	9	5.2	12	5.9
ENE.	5	4.5	5	3.2	8	5.9	9	6.0	16	12.2	10	6.9
E by N.	2	0.3	2	2.4	4	4.7	4	3.0	4	3.4	5	4.8
E.	3	3.4	1	0.2	2	1.2	2	0.9	2	1.1	4	3.0
E by S.	1	0.8	2	2.7	3	2.5
ESE.	1	0.5	2	0.3
SE by E.	1	0.3
SE.	2	3.2	2	3.2	1	0.1	1	0.5	2	1.3	1	0.2
SE by S.	3	3.5	1	0.8	2	0.4
SSE.	2	2.6	1	0.2	2	1.3	4	1.5	3	1.2
S by E.	1	0.4	3	2.1	7	3.7	7	7.3	3	4.2	3	2.2
S.	3	5.8	5	5.0	3	3.4	7	4.4	6	8.1	5	3.5
S by W.	1	1.4	4	2.0	3	2.9	3	2.0	6	5.7	7	5.1
SSW.	8	11.7	9	4.9	16	9.2	16	10.9	16	9.5	13	13.5
SW by S.	8	9.8	11	8.1	10	7.9	16	16.6	20	17.3	15	12.1
SW.	28	31.4	28	23.7	32	33.9	42	34.7	39	42.0	41	32.9
SW by W.	11	7.8	12	12.0	17	12.6	12	15.4	11	15.8	16	10.6
WSW.	9	9.4	12	6.2	11	7.9	12	4.8	12	8.8	12	8.4
W by S.	4	1.5	7	4.1	8	6.8	8	7.8	8	7.3	4	3.1
W.	6	2.3	7	12.3	8	9.3	7	16.4	9	14.2	11	15.9
W by N.	4	9.4	2	6.4	5	8.6	4	2.5
WNW.	3	10.2	2	4.3	3	2.7	2	2.3	5	2.4	7	11.5
NW by W.	3	6.4	1	6.0	2	0.5	4	2.6	3	3.3	3	2.0
NW.	2	1.4	5	2.1	6	4.6	11	15.7	3	4.2	1	0.5
NW by N.	1	6.8	2	1.0	4	7.7	3	6.4	4	6.4	4	1.4
NNW.	4	1.5	4	1.2	4	2.4	6	2.4	7	4.5	6	3.4
N by W.	3	2.0	4	10.6	10	11.8	9	12.5	8	12.2	6	12.0

each Observation Hour, with a Pressure of one-tenth of a pound or upwards upon a square the *sums* of the Pressures.

6 ^h .		8 ^h .		10 ^h .		9 Observations.		12 Observations.		Mean Pressure.	Wind blowing from
Times.	Press.	Times.	Press.	Times.	Press.	Times.	Press.	Times.	Press.		
	lb.		lb.		lb.		lb.		lb.	lb.	
7	6.8	3	3.3	1	0.2	39	28.4	43	30.3	0.70	N.
3	1.8	4	3.4	2	1.9	25	25.4	32	36.3	1.13	N by E.
3	0.6	7	2.7	5	2.1	46	22.0	56	25.6	0.46	NNE.
13	6.1	7	2.3	9	3.7	100	40.3	131	53.9	0.41	NE by N.
21	9.2	19	7.9	8	3.5	117	59.8	142	69.5	0.49	NE.
7	2.7	5	1.7	2	0.8	55	26.5	59	29.2	0.50	NE by E.
9	6.8	9	2.8	4	1.3	75	49.6	88	58.3	0.66	ENE.
5	2.8	4	2.7	4	2.8	34	26.9	43	31.5	0.73	E by N.
3	0.9	1	0.5	18	11.2	23	16.3	0.71	E.
1	1.2	7	7.2	7	7.2	1.03	E by S.
...	1	0.1	4	0.9	5	1.0	0.20	ESE.
...	1	0.3	1	0.3	0.30	SE by E.
4	1.5	13	10.0	16	14.8	0.92	SE.
1	0.1	7	4.8	7	4.8	0.69	SE by S.
2	0.2	4	0.7	2	3.3	20	11.0	26	19.9	0.77	SSE.
3	1.7	3	1.6	4	4.2	34	27.4	42	34.3	0.82	S by E.
4	6.2	3	1.7	2	1.4	38	39.5	46	50.3	1.09	S.
2	0.6	2	1.2	28	20.9	30	23.0	0.77	S by W.
14	13.6	10	3.2	7	5.6	109	82.1	137	111.2	0.81	SSW.
12	7.0	11	10.8	5	11.4	118	101.0	152	132.8	0.87	SW by S.
40	32.3	33	34.7	31	27.4	314	293.0	403	381.2	0.95	SW.
15	13.3	10	8.0	4	3.8	108	99.3	149	131.6	0.88	SW by W.
10	5.3	10	2.8	8	4.0	96	57.6	122	77.7	0.64	WSW.
2	1.0	2	2.4	6	5.9	49	39.9	66	54.0	0.82	W by S.
8	5.7	6	7.0	5	2.3	67	85.4	95	100.0	1.05	W.
4	3.3	2	0.4	1	0.2	22	30.8	23	31.1	1.35	W by N.
6	8.1	2	3.5	30	45.0	38	65.5	1.72	WNW.
1	0.2	4	4.2	3	5.6	24	30.8	33	48.8	1.48	NW by W.
4	11.0	2	6.1	34	45.6	42	52.0	1.24	NW.
1	0.8	1	0.8	2	0.7	22	32.0	33	45.9	1.39	NW by N.
5	3.1	6	4.3	5	6.2	47	29.0	62	40.7	0.66	NNW.
2	1.4	3	1.4	3	1.9	48	65.8	57	71.7	1.26	N by W.

After the number of the times which the wind blew, and the sums of the pressures for the observation hours, the sums of the times blowing and pressures for all the 9 observations are given, and next the sums of the times blowing and pressures for 12 observations, three times the mean of the sums for 18^h and 10^h being taken as the sums for the three observations wanting to complete the day. The following quantities have also been made use of in forming the sums for 12 observations :—

Direction.	Times.	Sums of Pressures. lb.	Direction.	Times.	Sums of Pressures. lb.
NNW.	1	0·2	W by S.	2	3·0
NW by N.	6	2·7	SW by W.	18	14·9
NW.	5	4·3	SSW.	5	3·2
W.	12	7·7			

These being estimated for the first week of January, and for the observation at 18^h, omitted in the second week.

Diurnal Variation of the number of the times which the Wind blew in 1843.—The following are the sums of the number of times which the wind blew, at each observation hour, with a pressure of one-tenth of a pound or upwards on a square foot of surface, as obtained from Table XXXI. :—

	5 ^h 10 ^m .	7 ^h 10 ^m .	9 ^h 10 ^m .	11 ^h 10 ^m A.M.	1 ^h 10 ^m P.M.	3 ^h 10 ^m .	5 ^h 10 ^m .	7 ^h 10 ^m .	9 ^h 10 ^m .
	138	166	205	233	256	242	212	171	126
Differences,	28	39	28	23	14	30	41	45	

The number of times which the wind blew increased from 5^h 10^m A.M. till 1^h 30^m P.M., the interpolated period of maximum, and diminished from 1^h 30^m P.M. till 9^h 10^m P.M. The number increases most rapidly about 8^h A.M., and diminishes most rapidly about 8^h P.M. The wind, therefore, blew most frequently exactly at the time of the maximum temperature of the air.

Diurnal Variation of the number of Points of the Compass in which the Wind blew.—The numbers of the points of the compass in which the wind blew at the observation hours, are—

5 ^h 10 ^m .	7 ^h 10 ^m .	9 ^h 10 ^m .	11 ^h 10 ^m A.M.	1 ^h 10 ^m P.M.	3 ^h 10 ^m .	5 ^h 10 ^m .	7 ^h 10 ^m .	9 ^h 10 ^m .
27	27	30	29	31	30	30	26	25

The wind, therefore, seems to blow less steadily from 9 A.M. till 5 P.M. than before the former and after the latter of these hours.

Diurnal Variation of the Sums of Pressures of the Wind.—This, of course, is the same as that of the means, Table XXVII., or a maximum about 25^m after Noon. The sums are as follow :—

5 ^h 10 ^m .	7 ^h 10 ^m .	9 ^h 10 ^m .	11 ^h 10 ^m A.M.	1 ^h 10 ^m P.M.	3 ^h 10 ^m .	5 ^h 10 ^m .	7 ^h 10 ^m .	9 ^h 10 ^m .
lb. 139·5	lb. 133·5	lb. 170·4	lb. 211·5	lb. 224·0	lb. 192·1	lb. 156·1	lb. 118·7	lb. 103·8

Diurnal Variation of the Mean Pressure of the Wind while blowing.—This is obtained by dividing the sums of the pressures by the number of times which the wind blew, and is as follows :—

5 ^h 10 ^m .	7 ^h 10 ^m .	9 ^h 10 ^m .	11 ^h 10 ^m A.M.	1 ^h 10 ^m P.M.	3 ^h 10 ^m .	5 ^h 10 ^m .	7 ^h 10 ^m .	9 ^h 10 ^m .
lb. 1·01	lb. 0·80	lb. 0·83	lb. 0·91	lb. 0·88	lb. 0·79	lb. 0·74	lb. 0·69	lb. 0·82

The wind, while blowing, was a minimum about 7^h 40^m A.M.
 maximum at Noon.
 minimum about 7^h 10^m P.M.

The greatest force occurred at 5^h 10^m A.M.; the maximum pressure of the wind while blowing probably occurs, therefore, at or after midnight.

The fact that the wind blows with the greatest force at Noon, but the greatest number of times at 1^h 30^m P.M., the time of the maximum temperature, explains why the *sums* of the pressures attain their maximum between these two periods.

Times which the Wind blew from the different Points of the Compass.—The wind blew most frequently from the SW., and least so from SE. by E.; the number for the former, from 12 daily observations, being 403, and for the latter, 1. If we take the sums of the times from 12 observations, for the five points SSW. to WSW., corresponding to SW., from WSW. to WNW., corresponding to W., and so for the others of the 8 principal points, we find that the number of times which the wind blew was the maximum at SW., a secondary minimum at NW., a secondary maximum at NE., and the minimum at SE. The sums are as follow :—

SW.	W.	NW.	N.	NE.	E.	SE.	S.
963	344	208	250	476	166	55	281

The wind blew twice as often from the points included between N., W., and S., as from the opposite semi-circle N., E., and S.

Sums of the Pressures with which the Wind blew from the different Points of the Compass.—The greatest sum is that for SW., being, from 12 observations, 381 lb., and the least that for SE. by E., being 0·3 lb. Summing the pressures for each five points, including the 8 principal points as above, we have, for 12 observations,—

SW.	W.	NW.	N.	NE.	E.	SE.	S.
lb.	lb.	lb.	lb.	lb.	lb.	lb.	lb.
834·5	328·3	252·9	204·6	236·5	114·3	40·8	238·7

The sums of the pressures are, therefore, greatest about SW.; they diminish round by W. and NW. to N., where there is a secondary minimum, a secondary maximum occurs about NE.; the sums then diminish to SE., about which they are the minimum, increasing from thence to SW.

Mean Pressure of the Wind while blowing from the different Points of the Compass.—The mean pressure of the wind was greatest while blowing from WNW., being 1·72 lb., and least while blowing from the opposite point ESE., being 0·20 lb. If the sums of the pressures about the 8 principal points be divided by the times which the wind blew about the same points, we obtain the following means :—

SW.	W.	NW.	N.	NE.	E.	SE.	S.
lb.	lb.	lb.	lb.	lb.	lb.	lb.	lb.
0·87	0·95	1·22	0·82	0·50	0·69	0·74	0·85

The mean pressure with which the wind blows is therefore greatest about NW., it becomes less at the N., and is least at NE., from which point it increases gradually by SE., S., SW., and W., to the maximum at NW.

TABLE XXXII.—Sums of the Pressures of Wind in Table XXXI. resolved for each Hour into the Four Cardinal Points of the Compass, together with the Value and Direction of the Resultant.

Hour Göttingen Mean Time.	Resolved Sums in				Resultant.		
	N.	E.	S.	W.	Sums.	Means.	Directions.
	lb.	lb.	lb.	lb.	lb.	lb.	°
18 ^h	33·3	18·4	61·6	71·9	60·5	0·44	W. 28 S.
20 ^h	34·8	18·0	49·5	69·3	53·4	0·32	W. 16 S.
22 ^h	44·3	24·5	63·6	89·2	67·5	0·33	W. 17 S.
0 ^h	60·2	27·4	76·0	108·2	82·3	0·35	W. 11 S.
2 ^h	55·1	34·3	88·2	110·8	83·4	0·33	W. 23 S.
4 ^h	54·0	34·4	67·9	91·3	58·6	0·24	W. 14 S.
6 ^h	42·0	25·4	60·9	75·3	53·4	0·25	W. 21 S.
8 ^h	31·9	16·3	47·6	61·0	47·4	0·28	W. 19 S.
10 ^h	23·6	12·6	47·4	54·1	47·8	0·38	W. 30 S.
Sum of 9 Obs.	378·7	211·0	562·2	730·4	550·9	0·32	W. 19 S.
Sum of 12 Obs.	469·2	257·1	737·5	948·1	741·3	0·34	W. 21 S.

The mean resultants are obtained on dividing the sum resultants by the number of times which the wind blew.

Diurnal Variation of the Resolved and Resultant Pressures of the Wind.—The sums resolved in the E. attain their maximum latest in the day, about 2^h P.M.; the sums resolved in the W. attain their maximum earliest, about Noon; while the sums resolved in N. and in S. attain their maximum about 1^h P.M. The resultant sums of pressures attain their maximum about 0^h 30^m P.M., minima occur about 7^h A.M. and 8^h P.M. The mean resultant attains a maximum about Noon, the minimum occurs about 3^h 40^m P.M.; the maximum probably occurs near midnight, a secondary minimum occurs about 7^h A.M.

The Direction of the Resultant seems to have a diurnal variation, being more towards the south of west in the morning and evening than about mid-day.

TABLE XXXIII.—Differences of the Directions of Motions of the Lower and Upper Currents of Air, as deduced from the Comparisons of the Direction of the Wind and Motions of the Clouds.

Currents.	Quadrant N. to E.			Quadrant E. to S.			Quadrant S. to W.			Quadrant W. to N.		
	No. of Obs.	Diffs. of Motion.	Mean Diff.	No. of Obs.	Diffs. of Motion.	Mean Diff.	No. of Obs.	Diffs. of Motion.	Mean Diff.	No. of Obs.	Diffs. of Motion.	Mean Diff.
Scud <i>minus</i> Wind	75	+27.9	+ 7.4	22	+ 29.3	+ 9.5	177	+23.7	+ 19.0	44	+18.5	+ 3.7
	30	-44.2		7	- 53.0		20	-22.6		18	-32.3	
Cir.-str. <i>minus</i> Wind	15	+48.3	- 1.9	12	+ 50.0	+33.2	87	+47.6	+35.4	23	+26.8	+ 1.7
	14	-55.7		2	- 67.5		12	-23.7		12	-46.6	
Cir.-str. <i>minus</i> Scud	14	+41.8	+ 5.6	7	+ 11.9	+ 3.6	57	+34.5	+23.9	28	+20.3	- 8.4
	9	-50.6		2	- 25.3		14	-19.7		19	-50.7	
Cirri <i>minus</i> Wind	8	+66.4	+13.4	3	+ 82.5	+82.5	42	+46.7	+34.5	10	+23.9	- 1.0
	6	-57.2		0		7	-38.6		5	-50.6	
Cirri <i>minus</i> Scud	7	+33.7	+21.3	1	+ 67.5	-45.0	22	+32.7	+20.1	16	+19.8	-15.9
	2	-25.0		1	-157.5		5	-35.6		8	-87.2	

This Table has been formed by taking the differences of the motions of the surface wind as observed on the anemoscope and the motions of the clouds. In order to arrive at any definite result, it was necessary to group the comparisons into quadrants of the compass. In several quadrants there are still too few comparisons to give satisfactory results.

The first column under each quadrant contains the number of times which an upper current was observed to proceed from a point *plus*, and the number of times which it was observed to proceed from a point *minus*, the direction of a lower current, from N. to E., S. and W. being the direction of reckoning. The second column under each quadrant contains the mean of the positive differences, and also the mean of the negative differences; the third column contains the mean difference of the motions from *all* the observations. Taking the first case for an example—the wind blowing *from* a point between N. and E. the scud was observed on 75 occasions to be moving from a point on an *average* of 27°.9 *south* of the point from which the wind was blowing; and on 30 occasions from a point on an *average* 44°.2 *north* of the point from which the wind was blowing. From *all* the 105 observations, the scud was found to move from a point 7°.4 *south* of that from which the wind blew.

In every quadrant, the upper currents were observed more frequently to be moving from points *plus* than from points *minus* those of the lower currents. In every quadrant, however, excepting S. to W., the average difference (with two exceptions) is greater for the *minus* than for the *positive* observations. In the quadrant S. to W. this is not the case: not only are the number of observations greatest for the upper current *positive* of the lower current, but the average difference of motion is also greatest (with one exception) when the upper

current is positive of the lower. If we take the mean difference from all the observations we arrive at the following results:—

The direction of the scuds or current immediately above the surface wind is always *plus*, reckoning from N. to E., S., and W., that of the surface wind, the average difference is greatest in the quadrant between S. and W.; in this quadrant the scud is, on the average of 197 comparisons, 19° more westerly than the surface current. The difference is least in the quadrant W. to N., where the scud, on an average of 62 comparisons, is only 3°·7 more northerly than the surface current.

The direction of the cirro-strati, or current immediately above the scuds, differs most from the motion of the surface wind in the quadrant from S. to W., being, on the average of 99 comparisons, 39°·4 more westerly than the surface wind, or nearly twice the deviation of the scud. The difference in the quadrant E. to S. is also positive, being 36°·9 on an average of 14 comparisons. In the other two quadrants the difference is very small.

The direction of the cirri, or current immediately above the cirro-strati, differs most from the motion of the surface wind in the quadrant E. to S., but there are only 3 comparisons. The difference in the quadrant S. to W. is nearly the same as for the cirro-strati; there is reason to believe, indeed, that, on many occasions, the two species are confounded, as the cirri frequently pass into cirro-strati.

The mean differences of the *mean* motion of the three currents, scud, cirro-strati, and cirri, from the motion of the surface wind, are as follow:—

N. to E., 147 comparisons; <i>mean</i> upper current <i>minus</i> surface current	= + 6°·2
E. to S., 46	= + 23·2
S. to W., 345	= + 27·6
W. to N., 112	= + 2·5

The difference of the directions of motion of the surface and *mean* upper current is therefore a minimum in the quadrant from W. to N.; the mean upper current is half-a-point S. of the surface current in the quadrant N. to E.; two points S. of the surface current in the quadrant E. to S.; and about two points and a half N. of the surface current in the quadrant S. to W.

If all the cases be taken in which the motions of the upper currents of cirro-strati and cirri were observed simultaneously with the current of scud, we obtain the following differences of motion of the mean upper current (cirro-strati and cirri), and lower current of clouds:—

N. to E., 32 comparisons; cirro-stratus current <i>minus</i> scud current	= + 11°·1
E. to S., 11	= - 5·8
S. to W., 98	= + 25·4
W. to N., 71	= - 12·2

The numbers of comparisons in the first two quadrants are too few for a good mean; from the other it appears that the current of cirro-stratus in the quadrant S. to W. is more than two points north of the current of scud; but, in the quadrant W. to N., it is about one point south of the scud.

If the mean differences of motion, scud *minus* wind, and cirro-stratus *minus* wind, were well determined, it is evident that, in subtracting the former from the latter, we would obtain the differences, cirro-stratus *minus* scud; and similarly for the differences cirri *minus* scud.

The means for these two differences, thus obtained, are—

N. to E., cirro-stratus and cirrus current <i>minus</i> scud current	= - 2°·0
E. to S.,	= + 54·7
S. to W.,	= + 19·7
W. to N.,	= - 3·3

As before, the difference for the quadrant E. to S. depends on too few observations, which is indeed the case with all the quadrants excepting that of S. to W.

TABLE XXXIV.—Daily, Weekly, and Monthly Means of the estimated surface of the Clouds, the whole sky covered being 10·0.

Civil Day.	Jan.	Feb.	March.	April.	May.	June.	July.	Aug.	Sept.	Oct.	Nov.	Dec.
1	[...]	3·8	4·4	10·0	2·2	10·0	8·2	10·0	8·4	[7·8]	6·3	3·2
2	4·1	6·5	9·2	[7·7]	4·2	10·0	[7·8]	8·9	7·8	4·7	7·9	5·7
3	10·0	4·8	7·6	6·2	4·0	10·0	6·2	7·5	[6·2]	9·6	5·5	[6·4]
4	4·3	7·1	0·9	8·9	5·8	[9·9]	4·8	8·5	2·9	9·4	6·8	9·6
5	2·5	[7·2]	[5·3]	7·4	4·5	10·0	10·0	4·6	2·7	9·5	[5·8]	7·2
6	9·9	5·1	9·0	9·9	7·9	10·0	7·4	[7·7]	6·8	9·6	6·6	4·0
7	7·1	9·9	5·4	5·0	[6·6]	9·5	9·3	9·7	1·1	6·7	5·1	8·3
8	[6·1]	10·0	0·0	7·7	9·6	7·7	7·8	9·9	0·9	[9·2]	2·9	4·4
9	7·7	9·7	4·6	[7·0]	6·7	9·9	[8·1]	6·0	0·8	9·7	5·8	7·8
10	6·1	8·0	7·0	5·9	4·9	7·5	8·8	2·7	[3·6]	9·9	10·0	[7·8]
11	3·3	10·0	10·0	4·7	4·7	[8·3]	5·2	8·5	9·1	10·0	9·6	7·6
12	2·7	[6·8]	[6·5]	8·8	10·0	10·0	9·9	1·9	7·9	5·8	[7·2]	9·2
13	10·0	4·8	7·2	7·1	10·0	9·9	6·5	[5·6]	1·8	2·2	5·4	9·7
14	5·8	4·0	4·2	9·5	[9·1]	4·6	4·7	3·3	7·2	1·5	5·1	7·0
15	[7·1]	4·2	6·2	9·4	10·0	0·5	4·7	9·6	4·4	[4·0]	7·6	7·0
16	5·5	5·3	10·0	[8·3]	10·0	4·8	[6·9]	7·6	3·7	5·5	6·5	4·0
17	9·3	5·5	9·9	7·3	9·9	6·1	10·0	6·6	[5·8]	7·8	5·7	[7·9]
18	9·4	3·1	9·0	8·5	7·4	[5·8]	7·1	5·6	7·7	1·1	1·8	9·7
19	8·8	[7·3]	[9·3]	8·1	6·9	9·5	8·4	3·9	6·3	2·1	[5·6]	10·0
20	6·9	10·0	9·6	8·6	8·3	7·9	9·4	[5·5]	5·5	8·6	8·2	9·6
21	4·8	10·0	9·5	9·2	[8·8]	6·2	7·1	6·5	4·3	6·5	7·1	2·9
22	[7·0]	10·0	8·0	10·0	10·0	5·3	9·7	8·9	0·1	[5·2]	4·1	7·1
23	6·5	10·0	7·8	[7·9]	10·0	5·4	[8·6]	1·3	0·3	6·0	5·9	7·8
24	5·9	9·9	10·0	6·3	10·0	2·9	8·4	3·8	[4·8]	6·6	4·3	[6·5]
25	9·2	9·9	5·0	7·9	9·5	[6·5]	7·1	6·0	8·1	1·4	7·2	8·6
26	6·3	[8·3]	[6·7]	5·2	7·8	8·7	10·0	5·1	9·2	1·4	[5·3]	7·2
27	9·3	9·1	10·0	6·1	10·0	8·3	5·6	[5·1]	6·8	4·9	6·3	5·3
28	3·0	6·5	6·7	7·7	[9·0]	8·6	9·9	9·2	5·9	9·5	7·9	5·8
29	[5·1]		1·0	8·9	7·4	8·1	9·5	1·9	8·2	[5·5]	0·4	8·2
30	1·5		6·6	[5·5]	9·5	9·3	[8·8]	4·5	8·9	9·0	8·6	3·5
31	6·5		7·0		10·0		8·8	8·9		2·1		[5·4]
Mean	6·40	7·38	6·88	7·77	7·82	7·72	7·87	6·33	5·26	6·20	6·10	6·94

The daily means in this table have been obtained from the 9 two-hourly observations by the formula given for the temperature, Table I. The daily means in the first week of January are the means of the 4 three-hourly observations.

Annual Variation of the Surface of Cloud.—The surface of cloud is a minimum in January, the maximum in April, May, June, and July, the means for which four months differ little from each other; the minimum surface occurs in September, after which the surface increases till December. The following are the means for the three groups of seasons, namely,—

The mean meteorological seasons, for which June, July, and August, constitute Summer.
 The meteorological seasons for 1843, for which July, August, and September,
 The astronomical seasons, for which May, June, and July,

Seasons.	Mean Meteorological.	Meteorological for 1843.	Astronomical.
Spring,	7·49	7·77	7·34
Summer,	7·31	6·49	7·80
Autumn,	5·85	6·41	5·93
Winter,	6·91	6·89	6·48
Range of Means,	1·64	1·36	1·87

The astronomical group is the most distinct. The maximum occurs in summer and the minimum in autumn of that group. The greatest monthly mean is that for July, being 7·87; the least is that for September, being 5·26.

The mean for the year 1843 = 6·89.

TABLE XXXV.—Estimated Surface of Cloud, with reference to the Moon's Age and Declination.

Moon's Age.	No. of Days.	Surface of Cloud.	Moon's Age.	No. of Days.	Surface of Cloud.	After Moon farthest North.	No. of Days.	Surface of Cloud.	After Moon farthest North.	No. of Days.	Surface of Cloud.
15	9	6.9	0	12	5.4	0	11	7.0	14	11	7.7
16	11	6.6	1	10	7.4	1	12	7.1	15	12	7.2
17	10	6.8	2	11	6.8	2	9	7.9	16	9	6.3
18	11	7.3	3	9	6.1	3	11	6.3	17	11	7.0
19	10	7.0	4	11	6.5	4	12	6.9	18	12	6.2
20	9	7.3	5	10	7.8	5	11	6.4	19	11	5.3
21	12	6.9	6	9	6.8	6	12	6.5	20	12	6.5
22	9	7.5	7	12	7.1	7	11	6.9	21	11	6.7
23	11	7.8	8	10	6.6	8	12	6.5	22	12	6.5
24	10	7.2	9	11	7.2	9	9	7.2	23	9	8.0
25	11	6.7	10	9	7.4	10	11	8.2	24	11	7.4
26	10	6.5	11	11	6.6	11	12	8.2	25	12	6.7
27	9	6.8	12	10	7.0	12	11	7.5	26	11	5.2
28	11	6.7	13	9	7.5	13	12	7.5	27	11	5.8
29	9	6.5	14	12	6.4						

This Table has been formed from Table XXXIV. in the manner already indicated, Table X.

Surface of Cloud, with reference to the Moon's Age.—The following means of groups indicate that the surface of cloud is a minimum about new moon :—

12 days till 18 days, Full Moon,	6.9	27 days till 3 days, New Moon,	6.5
15 22 ...	7.0	0 7 ...	6.7
19 26 ...	7.1	4 11 ...	7.0
23 29 ...	6.9	8 14 ...	7.0

There is an appearance of a secondary minimum at full moon, but the differences of the means are very small.*

Surface of Cloud, with reference to the Moon's Declination.—The following means of groups seem to indicate that the surface of cloud is greatest a few days before the moon is farthest south, and least a few days before it is farthest north :—

25 days till 3 days, Moon farthest North,	6.6	11 days till 17 days, Moon farthest South,	7.3
0 6 ...	6.9	14 20 ...	6.6
4 10 ...	6.9	18 24 ...	6.7
7 13 ...	7.4	21 27 ...	6.6

Extremes of the Daily Mean Surface of Clouds for each Month, with the ranges of the monthly means, and number of days in each month wholly overcast :—

	Jan.	Feb.	March.	April.	May.	June.	July.	Aug.	Sept.	Oct.	Nov.	Dec.
Greatest,	10.0	10.0	10.0	10.0	10.0	10.0	10.0	10.0	9.2	10.0	10.0	10.0
Least,	1.5	3.1	0.0	4.7	2.2	0.5	4.7	1.3	0.1	1.1	0.4	2.9
Range,	8.5	6.9	10.0	5.3	7.8	9.5	5.3	8.7	9.1	8.9	9.6	7.1
No. of Days } Overcast, }	2	6	3	2	9	6	3	1	0	1	1	1

The surface of clouds was 10.0 on nine days in the month of May, and in the month of September no day was quite overcast. Only on one day was the sky perfectly free of clouds, namely, on the 8th of March ; on the 22d and 23d of September the amount was very small.

* If the heat from the Moon have any effect on the dissipation or formation of clouds, it is obvious that the effect will be greatest during the night, when the Moon is about full ; the want of observations from 9^h P.M. till 5^h A.M. would therefore vitiate the results more markedly than in previous cases investigated, where any effect of the Moon must be supposed sufficiently permanent to affect the means during the day as well as the night.

TABLE XXXVI.—Means of the Estimated Surface of Cloud at the Hours of Observation, for each Month and Quarter in 1843.

Period.	18 ^h .	20 ^h .	22 ^h .	0 ^h .	2 ^h .	4 ^h .	6 ^h .	8 ^h .	10 ^h .	Mean.	Range.
January	5.53	7.35	7.69	8.02	6.98	7.75	7.28	5.20	5.15	6.41	2.87
February	6.97	7.80	7.05	7.76	7.95	8.17	7.78	6.40	7.42	7.41	1.77
March	6.56	7.37	7.33	7.03	7.28	7.27	7.33	6.82	6.06	6.83	1.31
April	7.08	7.45	8.61	8.84	9.10	8.90	9.02	7.41	6.40	7.75	2.70
May	7.86	8.40	8.01	8.14	8.06	7.83	7.14	7.51	7.60	7.81	1.26
June	8.59	8.50	8.26	7.62	7.40	7.38	7.40	6.36	7.01	7.66	2.23
July	7.68	8.29	9.01	9.48	8.21	7.53	7.96	7.28	6.82	7.83	2.66
August	6.44	6.20	5.37	6.66	6.95	6.74	6.87	6.53	5.67	6.30	1.58
September	6.12	6.22	4.57	4.95	5.10	4.88	5.11	4.88	4.58	5.20	1.65
October	5.83	6.35	6.36	6.71	7.36	6.83	6.42	5.56	5.65	6.19	1.80
November	5.90	7.16	6.53	6.63	6.72	5.92	5.79	5.84	5.46	6.08	1.70
December	6.47	6.87	8.00	8.20	7.62	7.29	6.01	6.77	6.73	6.98	2.19
Spring	7.17	7.74	7.98	8.00	8.15	8.00	7.83	7.25	6.69	7.46	1.46
Summer	7.57	7.66	7.55	7.92	7.52	7.22	7.41	6.72	6.50	7.26	1.42
Autumn	5.95	6.58	5.82	6.10	6.39	5.88	5.77	5.43	5.23	5.82	1.35
Winter	6.32	7.34	7.58	7.99	7.52	7.74	7.02	6.12	6.43	6.93	1.87
The Year	6.75	7.33	7.23	7.50	7.39	7.21	7.01	6.38	6.21	6.87	1.29

The observations in the first week of January were not made use of in obtaining the hourly means for that month; no observations having been made at 18^h in the second week, a correction was applied to the mean for that hour of -0.48 , obtained from Table XXXIV. as follows:—

$$\{\text{Mean cloud, Jan. 9-31,} = 6.63, \text{ minus mean cloud, Jan. 16-31,} = 7.11\} = -0.48.$$

The means were afterwards corrected by $+0.30$, in order to render the mean for that month from these means equal to that obtained, Table XXXIV., from all the daily means.

Diurnal Variation of the Surface of Cloud.—The means for the various months present considerable irregularities, the maximum surface of cloud, however, occurs, with two or three exceptions, between 11 A.M. and 3 P.M. The following are the interpolated periods of the maximum surface of cloud for each of the mean meteorological seasons (as in the previous Table):—

Spring, the max., 1^h 0^m P.M.
 Summer, 10^h 0^m A.M.
 Autumn, 7^h 0^m A.M.; a Secondary min. about 9^h 30^m A.M.; a Secondary max. 1^h P.M.
 Winter, 11^h 0^m A.M.; 1^h 0^m P.M.; 3^h P.M.

There are other secondary maxima and minima, but they are probably accidental. The periods for the astronomical group of seasons are as follow:—

Spring, the max., 3^h P.M.
 Summer, 9^h A.M.
 Autumn, 2^h P.M.; a Secondary min. 9^h A.M.; a Secondary max. 6^h A.M.
 Winter, 11^h A.M.

The secondary minimum and maximum are well marked for autumn of this group; there are also inflexions or minima in the summer and autumn about 3^h P.M., the time at which inflexions occur in the curves for the aqueous vapour (Table XI.) From the astronomical group, the maximum surface of cloud seems to occur after noon in the spring and autumn, and before noon in the summer and winter. The minimum occurs after 9^h P.M.

The maximum in the means for the year occurs shortly before noon; a secondary maximum is shewn about 7^h A.M.; and a secondary minimum about 9^h A.M.

The Diurnal Range of the Surface of Cloud, as far as it can be deduced from the 9 two-hourly means, is a minimum in autumn and a maximum in winter.

TABLE XXXVII.—Quantity of Rain for each Month in 1843, by the Observatory Garden and Greenhouse Gauges.

Month.	Observatory Gauge.	Garden Gauge.	Greenhouse Gauge.
	in.	in.	in.
January	1.978	2.00	0.84
February	1.926	1.95 ?	0.95
March	0.934	0.95	0.70
April	2.231	1.95	1.63
May	3.237	3.17	2.53
June	1.311	1.24	1.09
July	2.676	2.47	2.26
August	2.752	2.51	2.36
September	1.080	1.00	0.86
October	3.645	3.73	3.19
November	2.038	1.82	1.45
December	0.949	0.66	0.49
Sums,	24.757	23.45	18.35

The quantity of rain for February, in the garden gauge, is estimated, the register for that month having been lost.

The greatest quantity of rain in any month is that for October, being, by the Observatory gauge, 3.645 in. The least monthly quantity is that for March, being, by the same gauge, 0.934 in. The quantity of rain is a minimum in the solstitial and equinoctial months of 1843, maxima occurring in the intervening months.

No conclusions can be drawn as to the cause of the differences of the sums for the Observatory and Garden gauges, as the gauges are not only at unequal heights above the level of the sea, but also above the soil.

The results for the Greenhouse gauge shew, that such a position is sufficient to destroy the value of the instrument as a pluviometer. (See *Introduction*, page lviii.)

The greatest amounts of rain found in the Observatory gauge at noon, having fallen within the previous 24 hours, for each month are as follow :—

Jan.	Feb.	March.	April.	May.	June.	July.	Aug.	Sept.	Oct.	Nov.	Dec.
in.	in.	in.	in.	in.	in.	in.	in.	in.	in.	in.	in.
0.650	0.387	0.290	0.468	0.403	0.420	0.386	1.411	0.252	0.890	0.460	0.253

The numbers of days in each month on which more than one-thousandth, one-hundredth, and one-tenth of an inch of rain was found in the Observatory gauge, are as follow :—

More than	Jan.	Feb.	March.	April.	May.	June.	July.	Aug.	Sept.	Oct.	Nov.	Dec.
0.001	23	22	16	19	23	16	22	19	12	30	27	17
0.010	14	17	11	13	17	10	14	15	6	19	16	7
0.100	6	6	3	9	11	7	8	8	2	10	6	2

The variation of the numbers follows nearly the same law as the variations of the monthly sums of rain fallen. In 1843, more than one-thousandth of an inch of rain fell on 246 days, or on about 6 days out of 9 ; more than one-tenth of an inch fell on 159 days, or on about 4 days out of 9 ; more than one-tenth of an inch fell on 78 days, or on about 2 days out of 9.

In dividing the monthly sums of rain by the number of days on which more than 0.001 inch fell, we obtain the following means for the quantity of rain which fell on days in which more than 0.001 was found in the Observatory gauge :—

Jan.	Feb.	March.	April.	May.	June.	July.	Aug.	Sept.	Oct.	Nov.	Dec.
in.	in.	in.	in.	in.	in.	in.	in.	in.	in.	in.	in.
0.086	0.088	0.058	0.117	0.141	0.082	0.122	0.145	0.090	0.121	0.113	0.056

These quantities follow nearly the same law as the monthly sums. We may therefore conclude, that for those months which have the greatest number of rainy days, the mean daily fall of rain is greatest ; or, that the oftener it rains, it rains the heavier.

PRINTED BY NEILL AND COMPANY, EDINBURGH.

MAKERSTOUN MAGNETIC OBSERVATORY. *PLATE I. Royal Soc. Trans. Edin. Vol. X. p. 1*

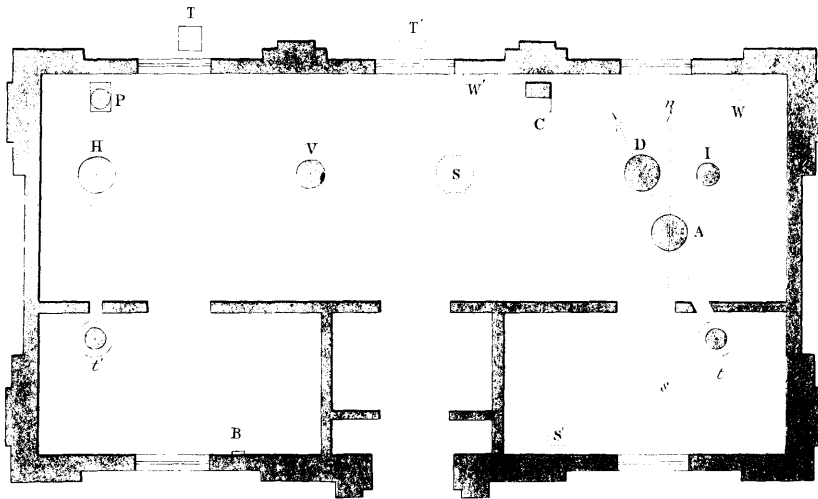



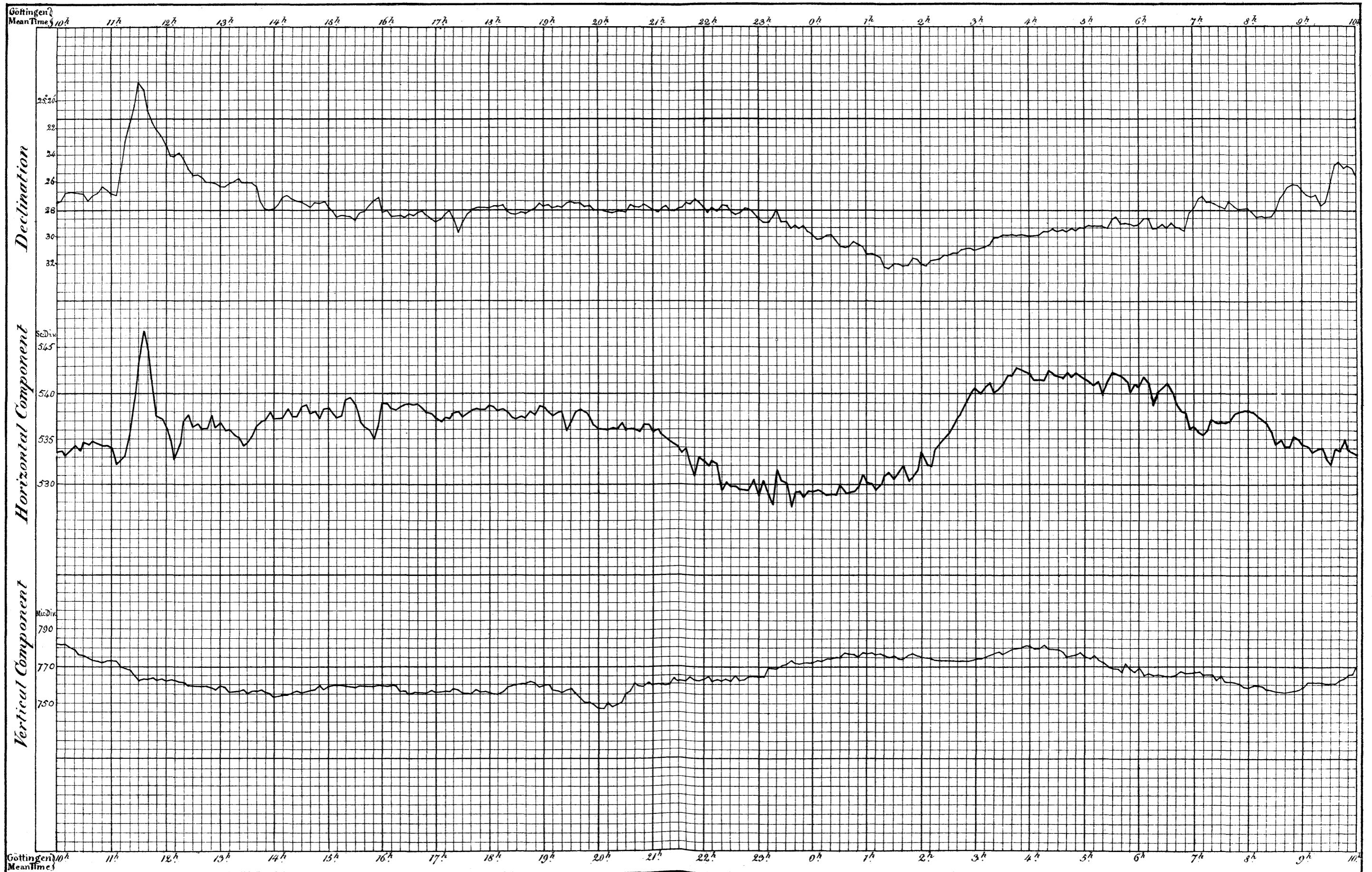

Ascending Curves indicate decreasing westerly declination and increasing force.

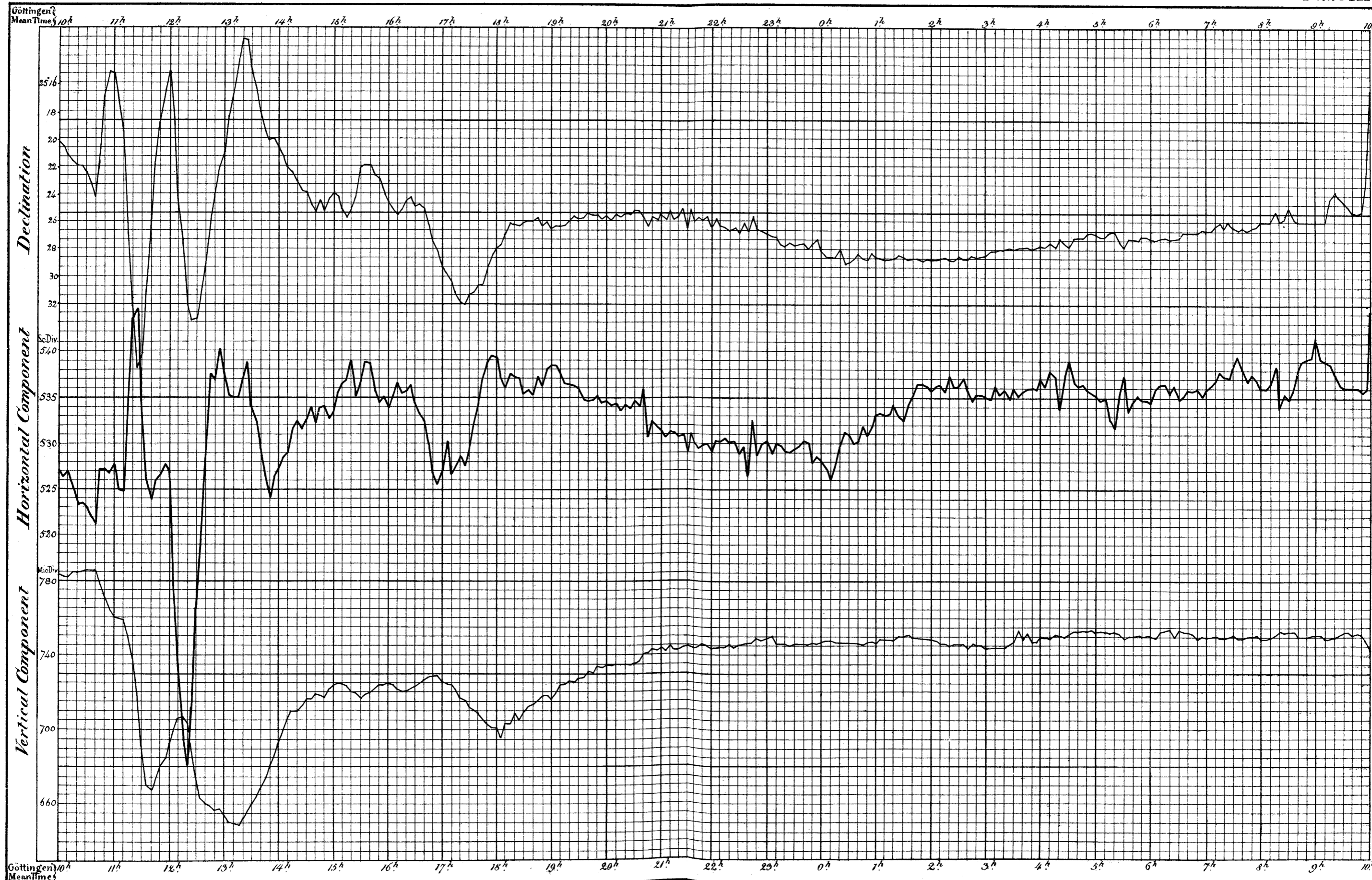

Ascending Curves indicate decreasing westerly declination and increasing force.

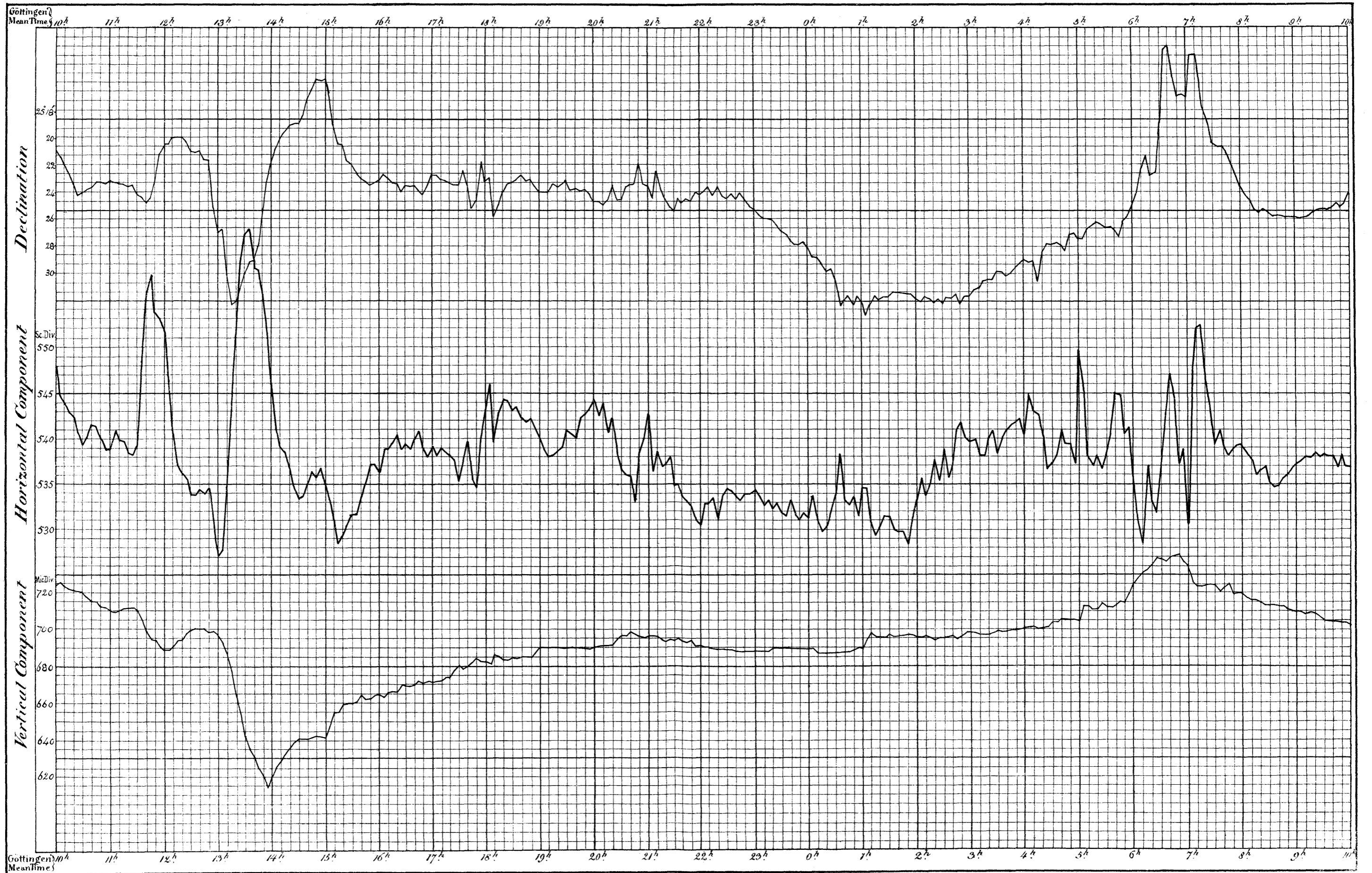

Ascending Curves indicate decreasing westerly declination and increasing force.

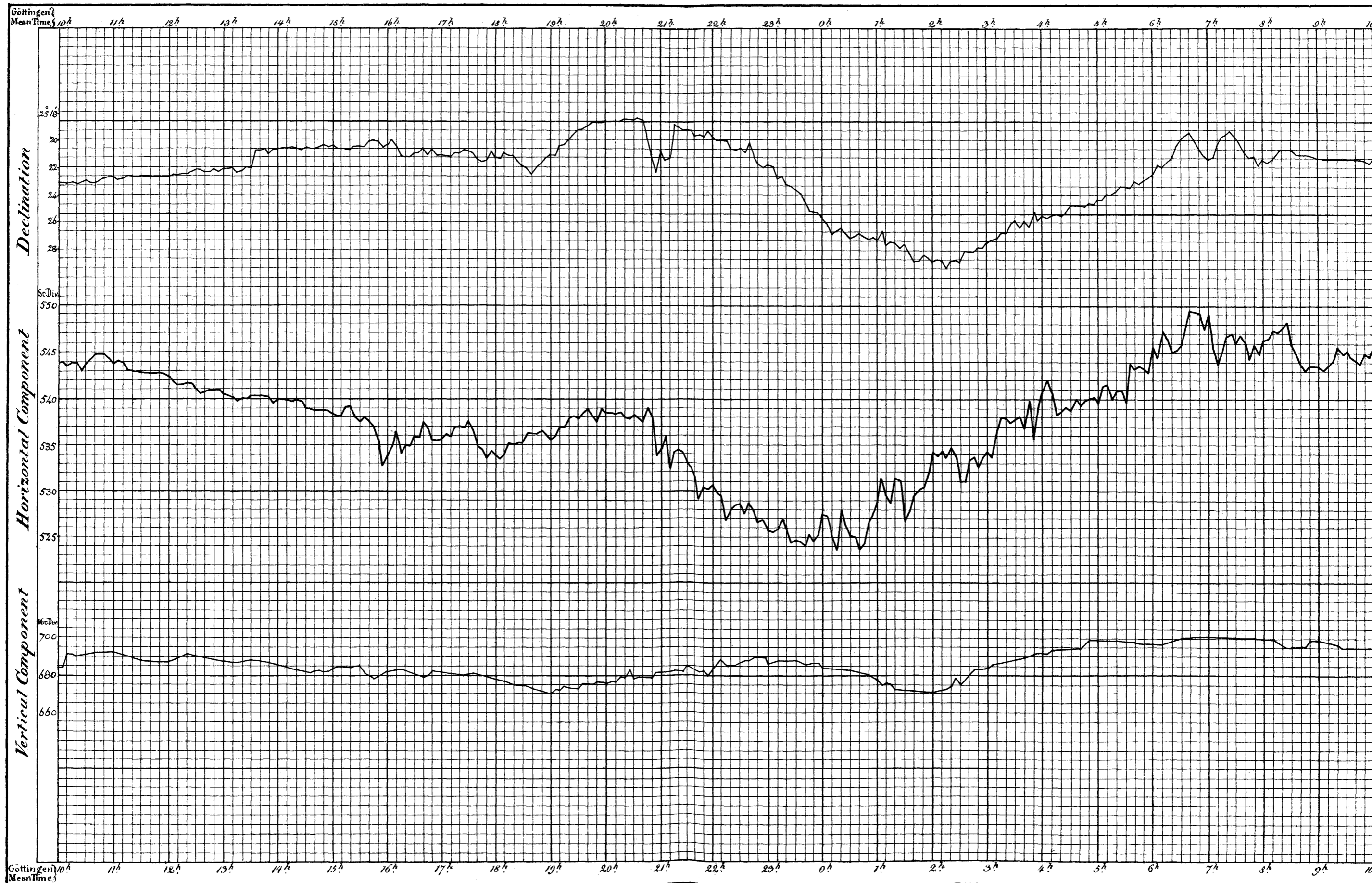

Ascending Curves indicate decreasing westerly declination and increasing force.

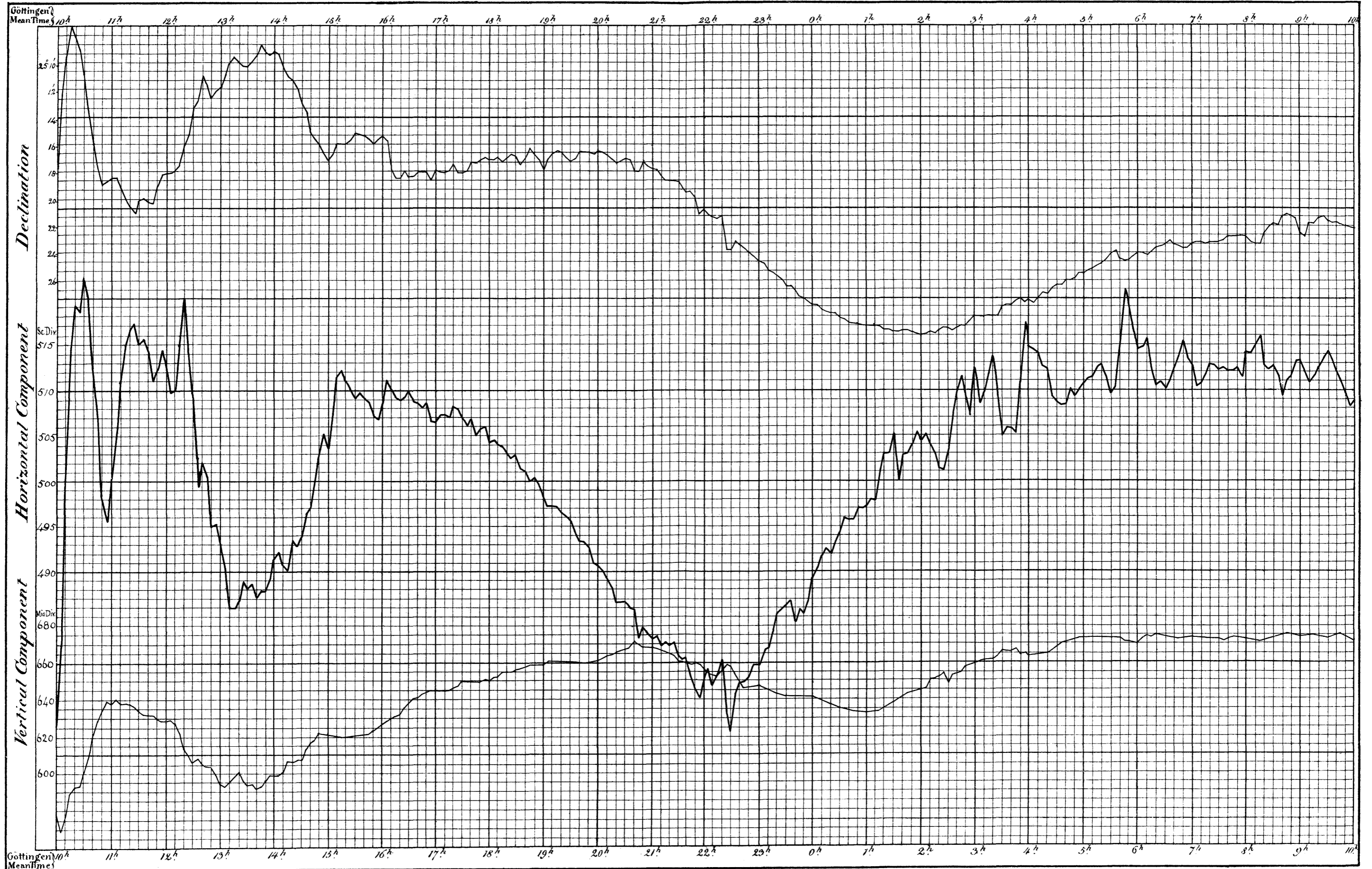

Ascending Curves indicate decreasing westerly declination and increasing force.

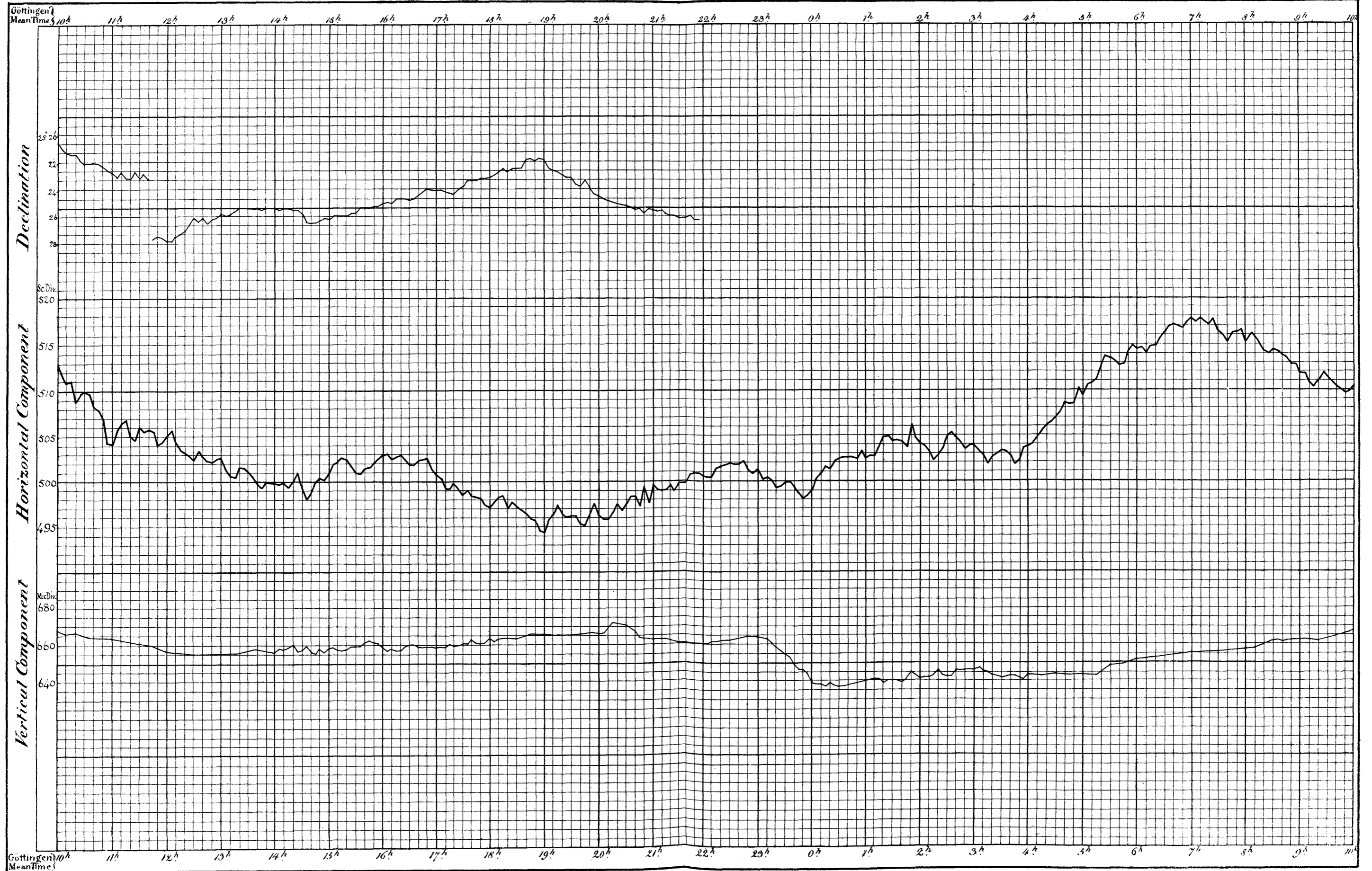

Ascending Curves indicate decreasing westerly declination and increasing force.

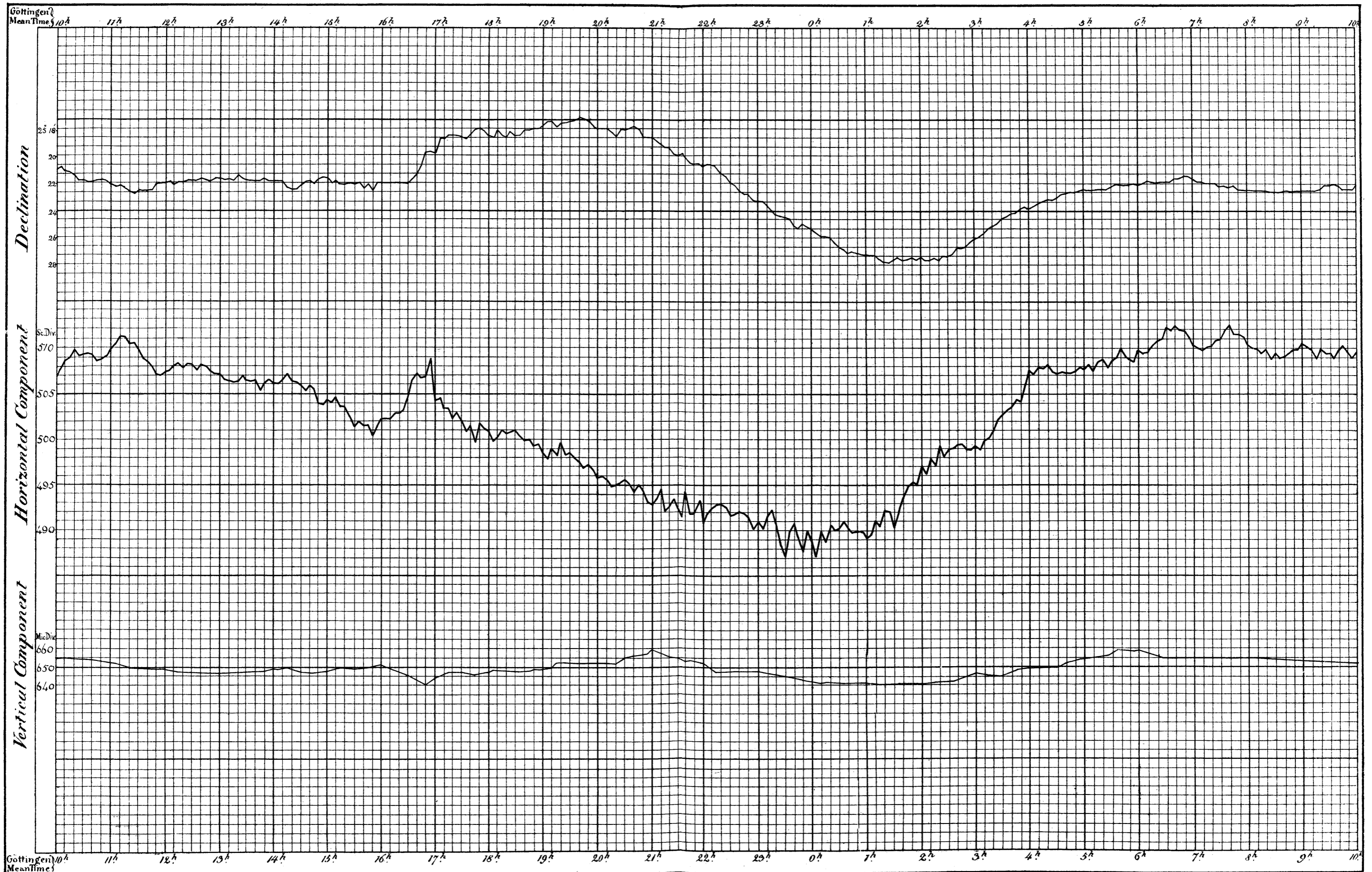

Ascending Curves indicate decreasing westerly declination and increasing force.



Ascending Curves indicate decreasing westerly declination and increasing force.

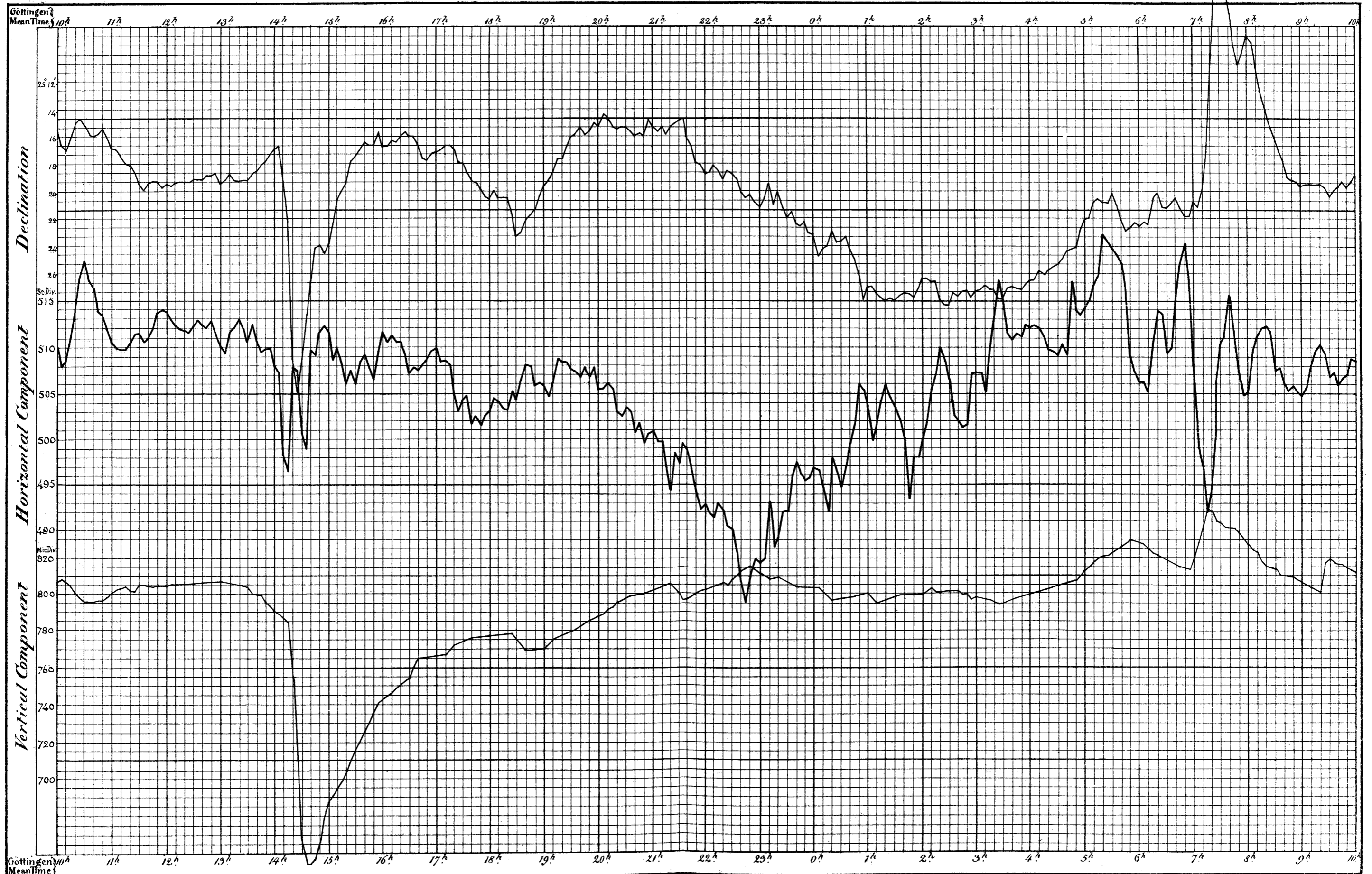

Ascending Curves indicate decreasing westerly declination and increasing force.



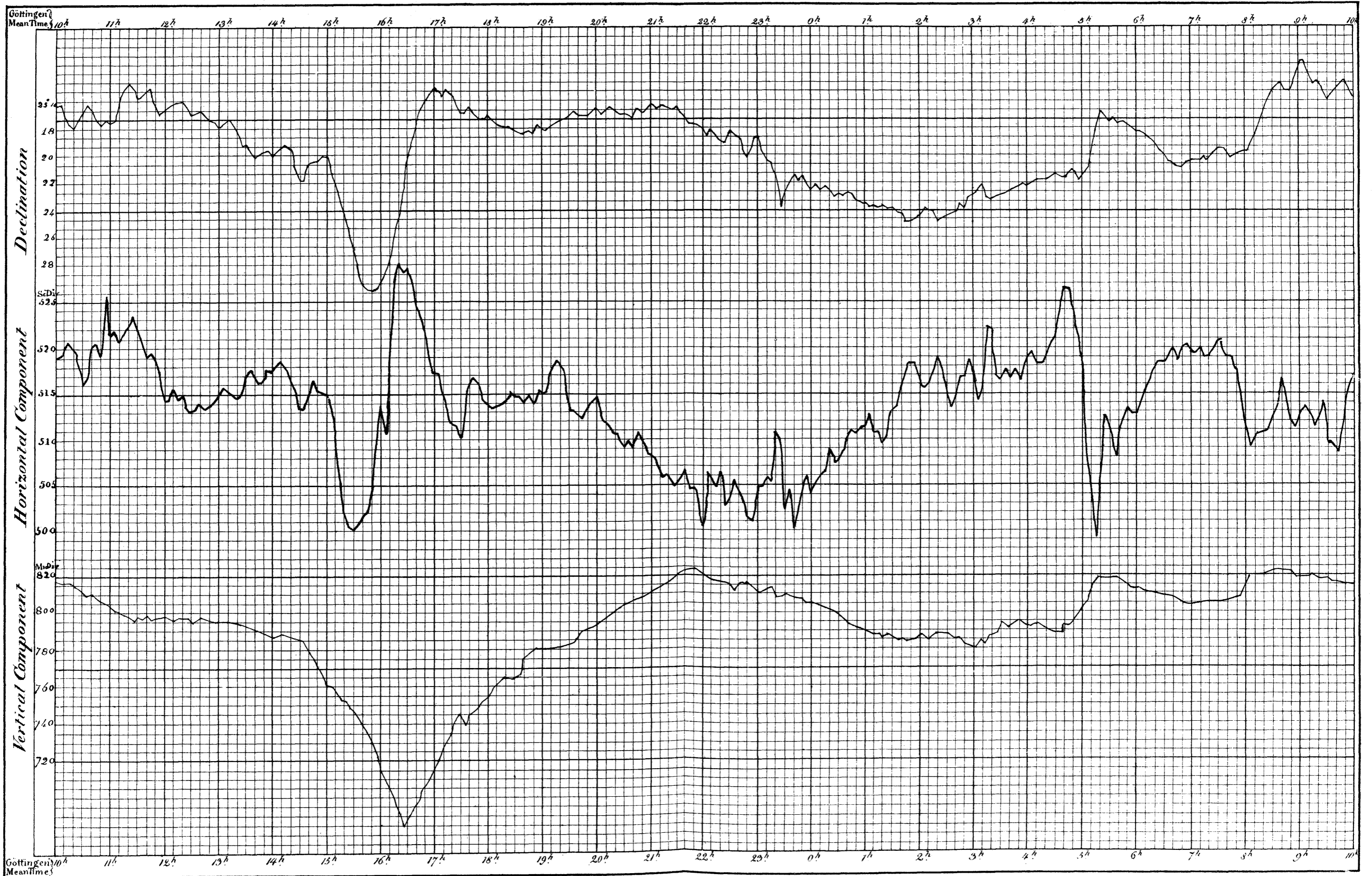

Ascending Curves indicate decreasing westerly declination and increasing force.

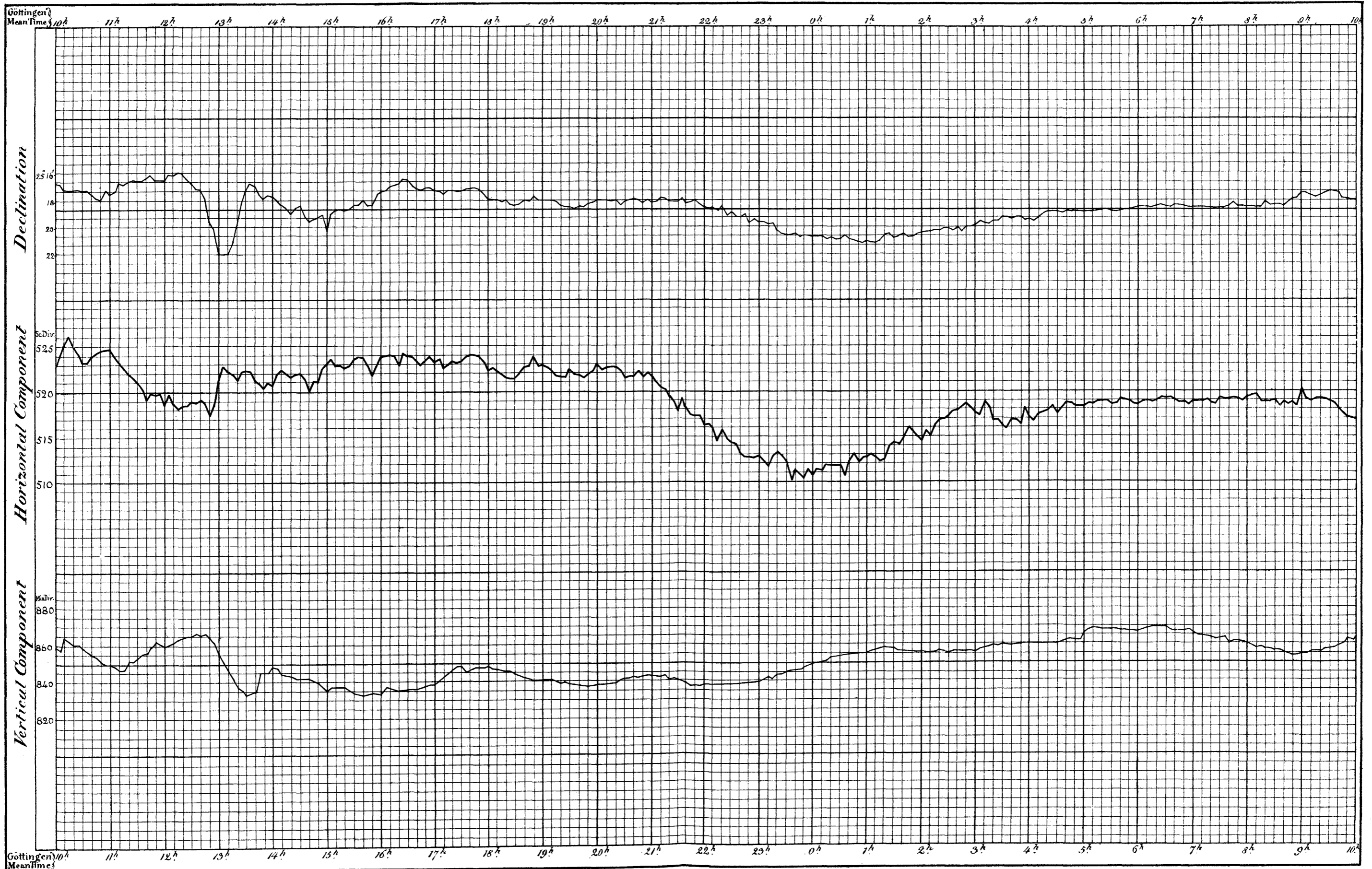

Ascending Curves indicate decreasing westerly declination and increasing force.

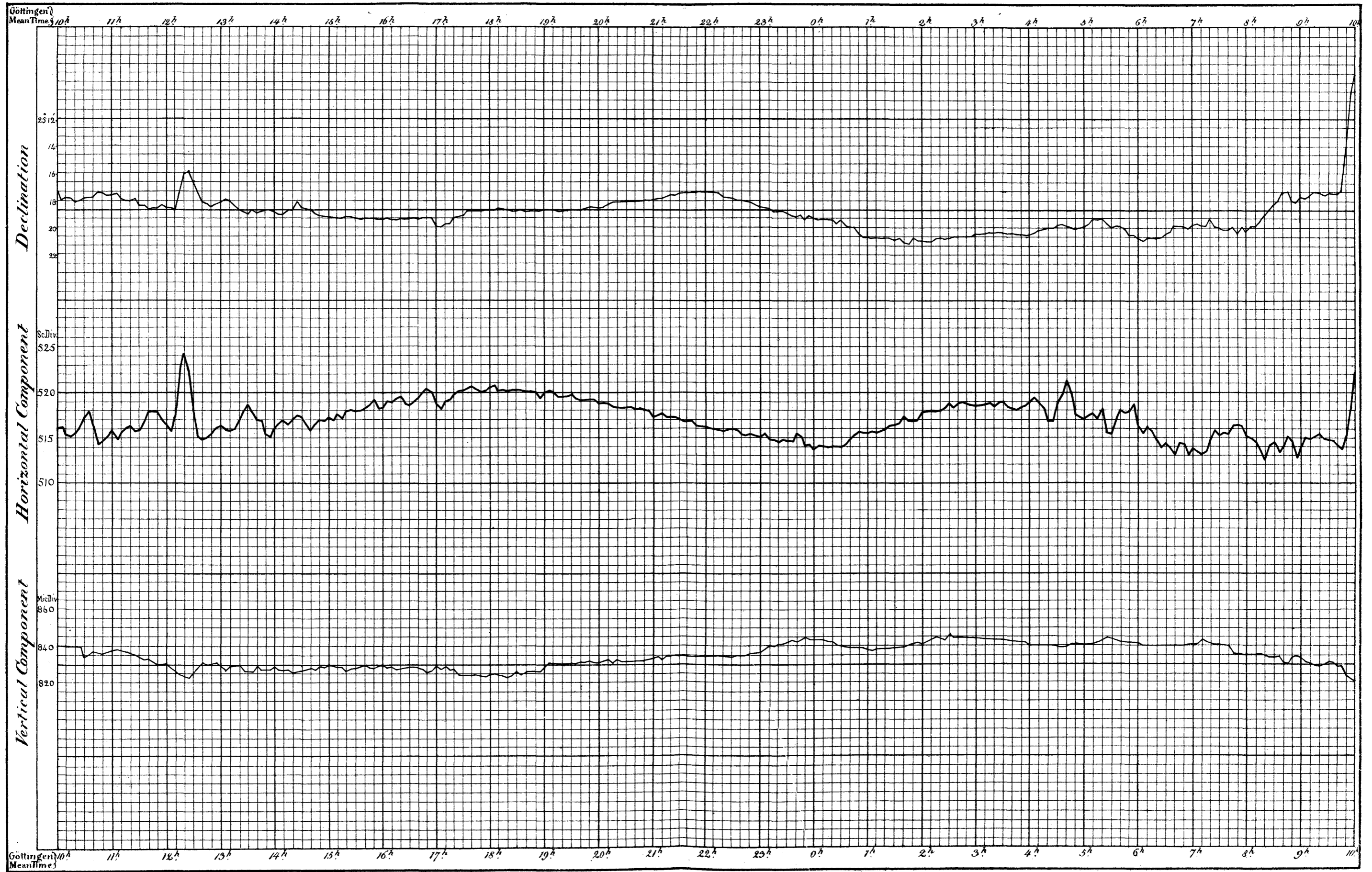

Ascending Curves indicate decreasing westerly declination and increasing force.

